

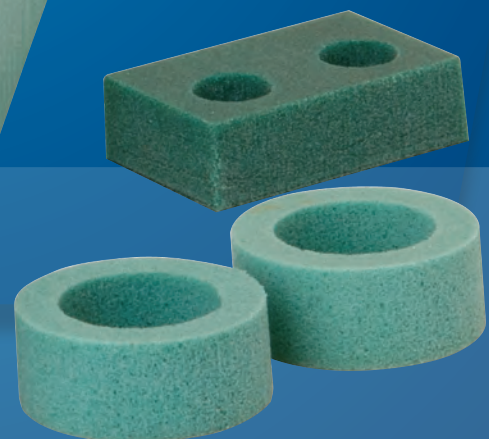

## *SLAB Plates for Shock Absorption and Vibration Damping*

***Designed to Absorb Shock Loads and Insulate Vibrations for...***

***Machine Tools, Textile Machinery, Crane Rails, Hydraulic Crushers, Presses/Stamping Machines, Air-Conditioning & Ventilating Machines and More***

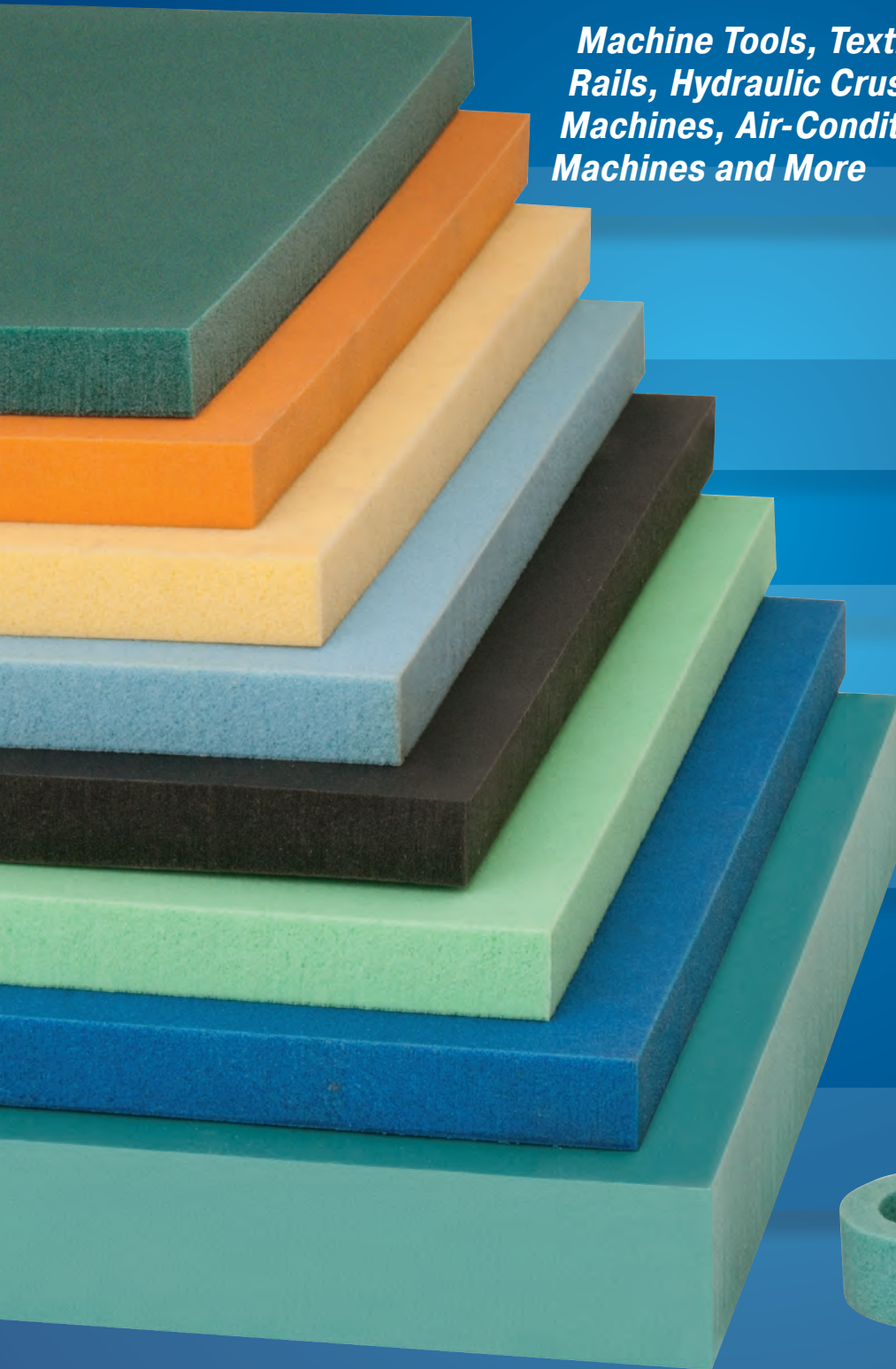

**SLAB damping plates** of the **SL-030, SL-100 and SL-300 series** are visco-elastic PUR materials that are manufactured according to a patented formula and which were especially designed to absorb shock loads. At the same time, the resulting structure-borne noise is effectively reduced. This material is characterized by its very high inner damping. The rebound elasticity is around < 30 % (Tolerance +/- 10%). The result makes this product an alternative to hydraulic end-of-travel damping, if the load doesn't need to be stopped accurately and the energy doesn't have to be reduced by 100%.

The densities of

SL-030 = 270 kg/m<sup>3</sup>,

SL-100 = 500 kg/m<sup>3</sup> and

SL-300 = 800 kg/m<sup>3</sup>

cover a wide spectrum of the energy absorption to the applied area. This enables a relatively independent choice of applied area.

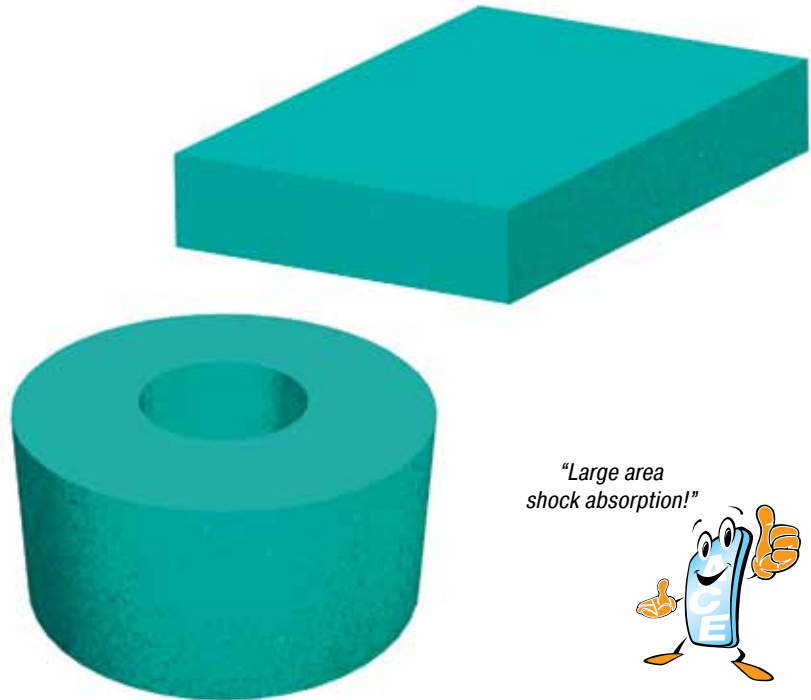

"Large area shock absorption!"

**Impact velocity range:** max.5 m/s

**Compression set:** ≤ 5%, at 50% of compression, 23 °C, 70 h, 30 min after unloading, according to EN ISO 1856

**Environment:** Resistant against ozone and UV radiation (also see chemical resistancy page 18)

**Material:** Mixed cellular PUR-Elastomer (polyether urethane), standard color green

**Standard density:** 270 kg/m<sup>3</sup>, 500 kg/m<sup>3</sup> and 800 kg/m<sup>3</sup>

**Impact resilience:** < 30%, tolerance +/- 10%, SL-030 and SL-100 according to DIN 53573, SL-300 according to DIN 53512 (measurement following the respective standard ).

**Fire rating:** B2, normally flammable according to DIN 4102

**Operating temperature range:** -30 °C to +50 °C, short-term higher temperature possible.

**Delivery form:** Thickness: 12.5 mm and 25 mm. Rolls: 1.5 m wide, 5.0 m long. Strips: Up to the maximum width and length. Other dimensions (also thickness), colors, shapes and cut-out parts on request.

**Possibilities for cutting:** Water jet cutting, stamping, splitting, sawing, drilling etc.

**Mounting style:** Bonding (see adhesive recommendation page 17), clamps, screws, etc.

**On request:** Available with compact polyurethane wearing surface, shore hardness: 82 shore Sh A.

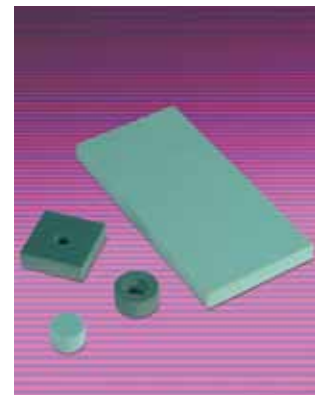

### Ordering Example

ACE-SLAB \_\_\_\_\_  
 Material Type \_\_\_\_\_  
 Material Thickness 12.5 mm \_\_\_\_\_  
 Customers Specific Dimension/Shape \_\_\_\_\_  
 (D-Number is assigned by ACE)

SL-030-12-Dxxxx

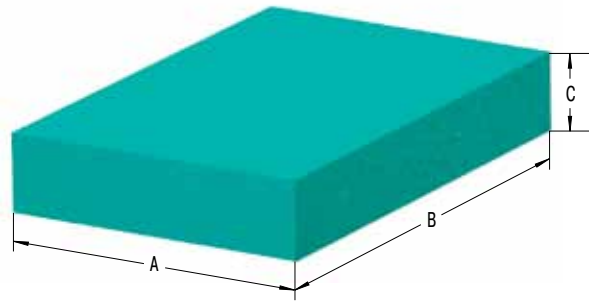

The chosen damping plate should be tested by the customer on the specific application.

### Characteristics of Type SL-030-12

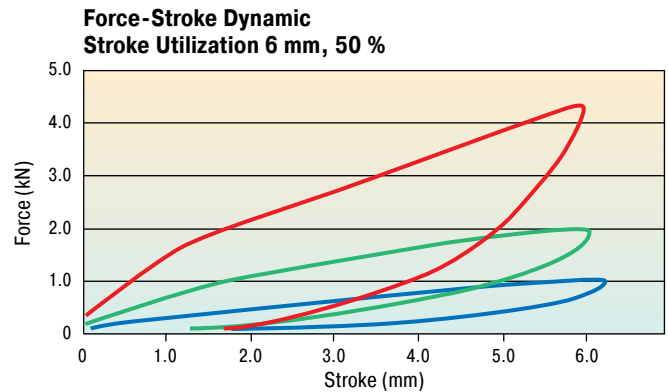
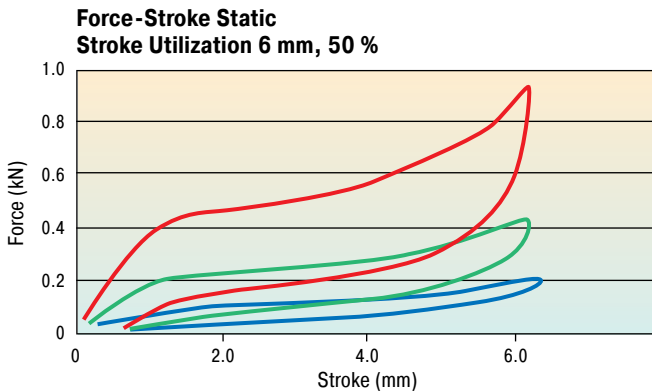
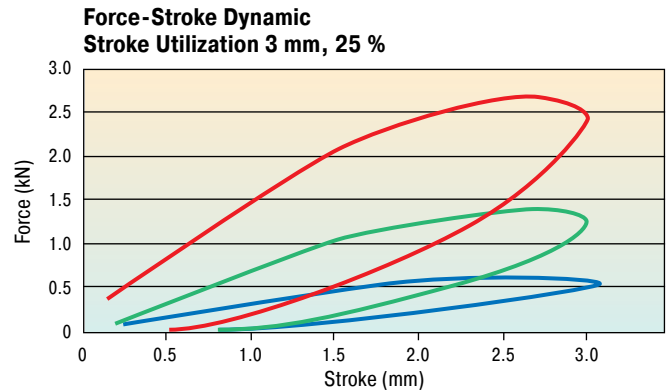
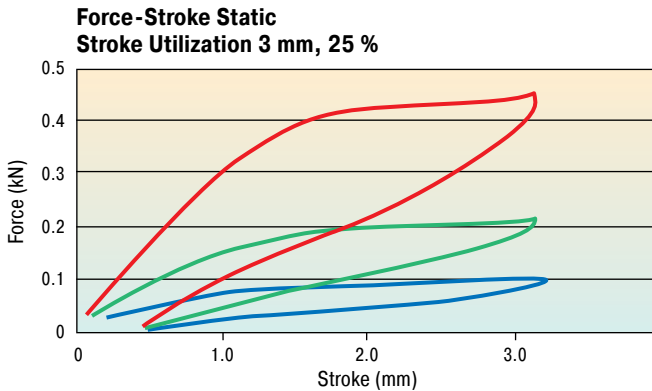

Load data:  
 static, between two level plates  
 deformation velocity:  
 1 % of the plate thickness/sec.

— Area 10 000 mm<sup>2</sup>  
 — Area 5 000 mm<sup>2</sup>  
 — Area 2 500 mm<sup>2</sup>

Load data:  
 dynamic, free-falling mass,  
 impact velocity:  
 about 1 m/s.

### Dimensions and Capacity Chart (Sample Plates MP1 to MP3)

Type	<sup>1</sup> E <sub>3</sub> max. Nm/Cycle	<sup>1</sup> Stroke Utilization mm	A	B	C	Area mm <sup>2</sup>	Density kg/m <sup>3</sup>	Return Time s	Weight kg
SL-030-12-D-MP1	2.3 (5.0)	3 (6)	50	50	12.5	2 500	270	Approx. 3 (4)	0.008
SL-030-12-D-MP2	4.3 (9.5)	3 (6)	70.7	70.7	12.5	5 000	270	Approx. 3 (4)	0.017
SL-030-12-D-MP3	9.5 (19.5)	3 (6)	100	100	12.5	10 000	270	Approx. 3 (4)	0.034

<sup>1</sup> Energy absorption and stroke utilization as well as the illustrated dynamic curve progression refer to a calculated free falling mass with an impact velocity of 1 m/s. For differing application data, these values can only be used as a reference. The energy absorption depends on the **individual impact surface** and stroke utilization. The longer the load duration the more the reduction in energy absorption (material fatigue).

#### Ordering Example

ACE-SLAB \_\_\_\_\_  
 Material Type \_\_\_\_\_  
 Material Thickness 25 mm \_\_\_\_\_  
 Customers Specific Dimension/Shape \_\_\_\_\_  
 (D-Number is assigned by ACE)

SL-030-25-Dxxxx

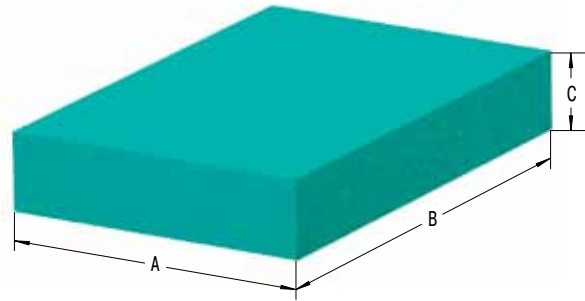

The chosen damping plate should be tested by the customer on the specific application.

#### Characteristics of Type SL-030-25

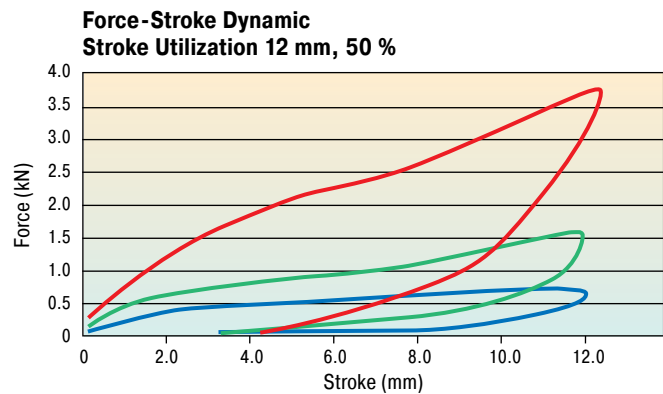
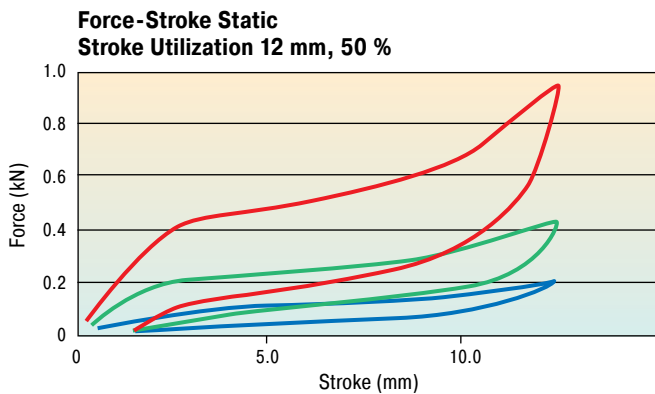
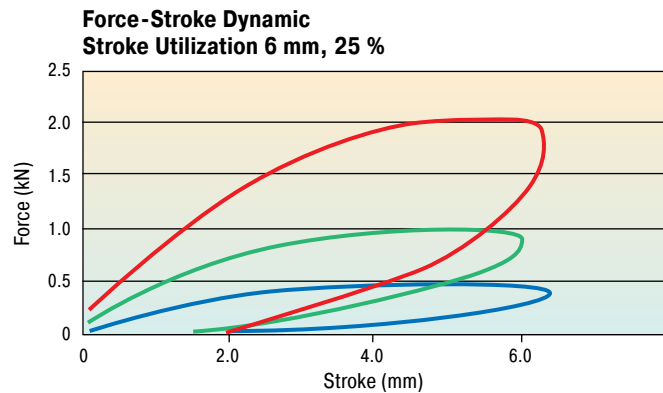
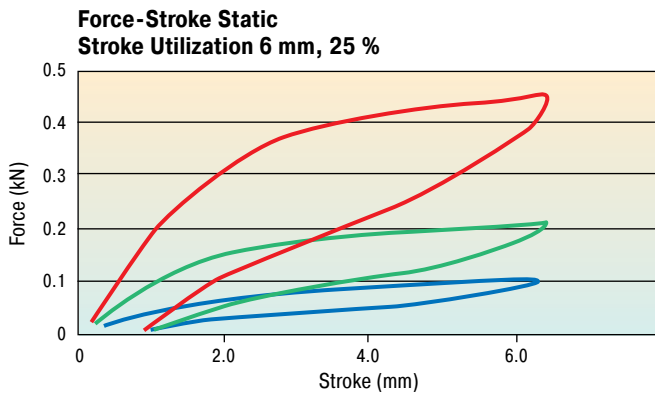

Load data:  
 static, between two level plates  
 deformation velocity:  
 1 % of the plate thickness/sec.

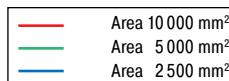

Load data:  
 dynamic, free-falling mass,  
 impact velocity:  
 about 1 m/s.

#### Dimensions and Capacity Chart (Sample Plates MP1 to MP3)

Type	<sup>1</sup> E <sub>3</sub> max. Nm/Cycle	<sup>1</sup> Stroke Utilization mm	A	B	C	Area mm <sup>2</sup>	Density kg/m <sup>3</sup>	Return Time s	Weight kg
SL-030-25-D-MP1	3.5 (6.0)	6 (12)	50	50	25	2 500	270	Approx. 4 (5)	0.017
SL-030-25-D-MP2	5.7 (11.5)	6 (12)	70.7	70.7	25	5 000	270	Approx. 4 (5)	0.034
SL-030-25-D-MP3	11.5 (21.5)	6 (12)	100	100	25	10 000	270	Approx. 4 (5)	0.068

<sup>1</sup> Energy absorption and stroke utilization as well as the illustrated dynamic curve progression refer to a calculated free falling mass with an impact velocity of 1 m/s. For differing application data, these values can only be used as a reference. The energy absorption depends on the individual impact surface and stroke utilization. The longer the load duration the more the reduction in energy absorption (material fatigue).

### Ordering Example

ACE-SLAB \_\_\_\_\_  
 Material Type \_\_\_\_\_  
 Material Thickness 12.5 mm \_\_\_\_\_  
 Customers Specific Dimension/Shape \_\_\_\_\_  
 (D-Number is assigned by ACE)

SL-100-12-Dxxxx

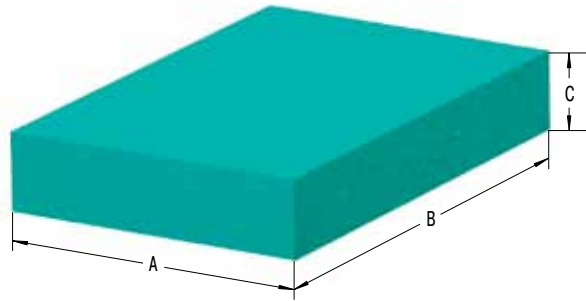

The chosen damping plate should be tested by the customer on the specific application.

### Characteristics of Type SL-100-12

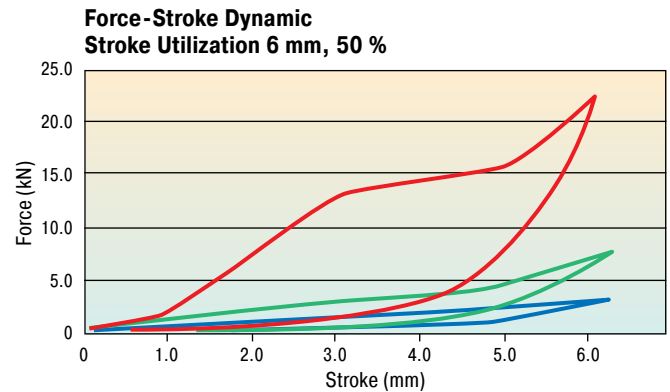
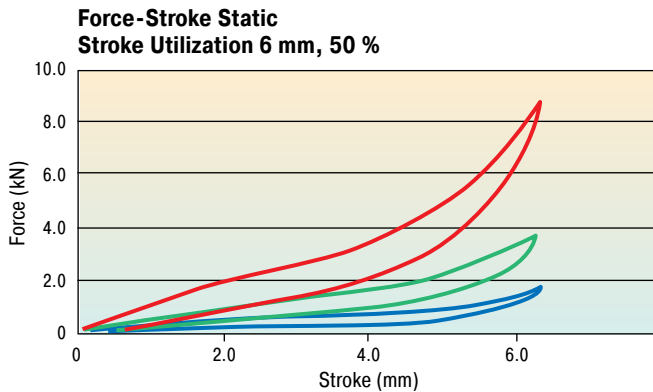
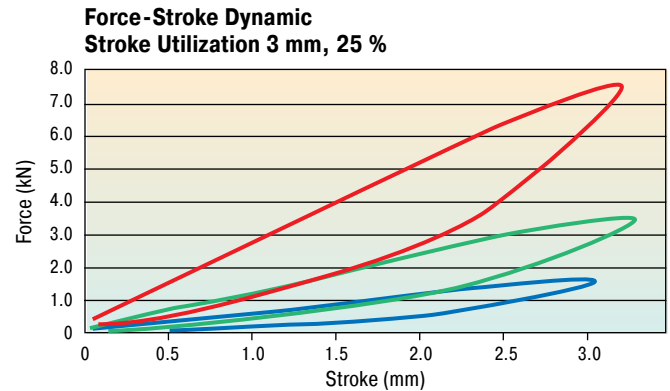
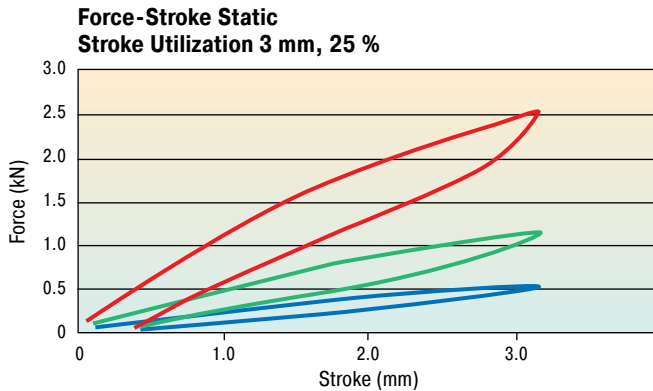

Load data:  
 static, between two level plates  
 deformation velocity:  
 1 % of the plate thickness/sec.

— Area 10 000 mm<sup>2</sup>  
 — Area 5 000 mm<sup>2</sup>  
 — Area 2 500 mm<sup>2</sup>

Load data:  
 dynamic, free-falling mass,  
 impact velocity:  
 about 1 m/s.

### Dimensions and Capacity Chart (Sample Plates MP1 to MP3)

Type	<sup>1</sup> E <sub>3</sub> max. Nm/Cycle	<sup>1</sup> Stroke Utilization mm	A	B	C	Area mm <sup>2</sup>	Density kg/m <sup>3</sup>	Return Time s	Weight kg
SL-100-12-D-MP1	4.5 (13.0)	3 (6)	50	50	12.5	2 500	500	Approx. 3 (4)	0.016
SL-100-12-D-MP2	11.5 (29.0)	3 (6)	70.7	70.7	12.5	5 000	500	Approx. 3 (4)	0.031
SL-100-12-D-MP3	23.0 (75.0)	3 (6)	100	100	12.5	10 000	500	Approx. 3 (4)	0.063

<sup>1</sup> Energy absorption and stroke utilization as well as the illustrated dynamic curve progression refer to a calculated free falling mass with an impact velocity of 1 m/s. For differing application data, these values can only be used as a reference. The energy absorption depends on the individual impact surface and stroke utilization. The longer the load duration the more the reduction in energy absorption (material fatigue).

#### Ordering Example

ACE-SLAB \_\_\_\_\_  
 Material Type \_\_\_\_\_  
 Material Thickness 25 mm \_\_\_\_\_  
 Customers Specific Dimension/Shape \_\_\_\_\_  
 (D-Number is assigned by ACE)

SL-100-25-Dxxxx

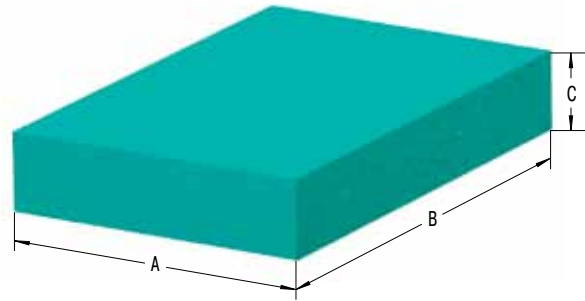

The chosen damping plate should be tested by the customer on the specific application.

#### Characteristics of Type SL-100-25

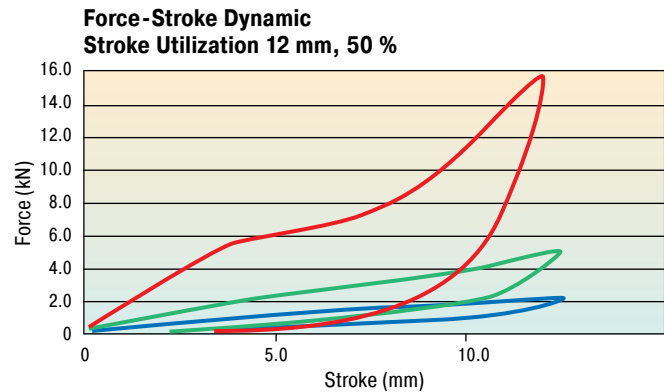
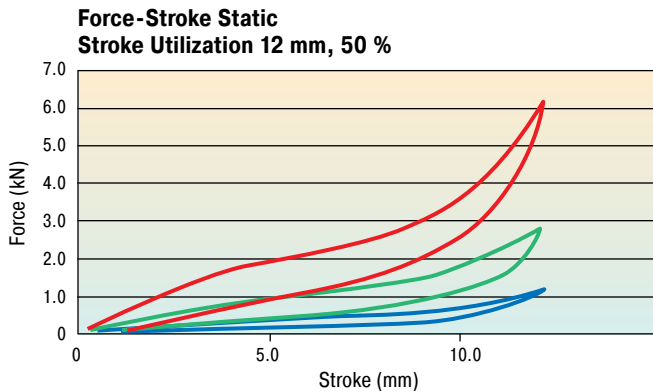
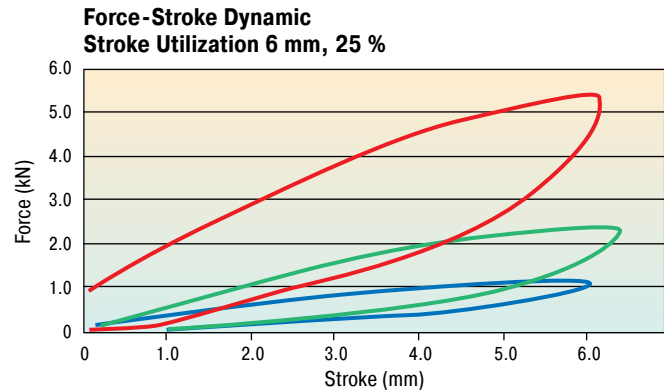
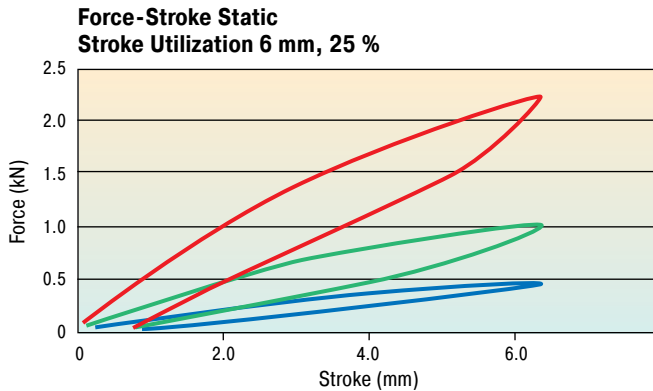

Load data:  
 static, between two level plates  
 deformation velocity:  
 1 % of the plate thickness/sec.

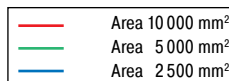

Load data:  
 dynamic, free-falling mass,  
 impact velocity:  
 about 1 m/s.

#### Dimensions and Capacity Chart (Sample Plates MP1 to MP3)

Type	<sup>1</sup> E <sub>3</sub> max. Nm/Cycle	<sup>1</sup> Stroke Utilization mm	A	B	C	Area mm <sup>2</sup>	Density kg/m <sup>3</sup>	Return Time s	Weight kg
SL-100-25-D-MP1	5.7 (14.5)	6 (12)	50	50	25	2 500	500	Approx. 4 (5)	0.031
SL-100-25-D-MP2	11.5 (33.0)	6 (12)	70.7	70.7	25	5 000	500	Approx. 4 (5)	0.062
SL-100-25-D-MP3	28.5 (90.0)	6 (12)	100	100	25	10 000	500	Approx. 4 (5)	0.125

<sup>1</sup> Energy absorption and stroke utilization as well as the illustrated dynamic curve progression refer to a calculated free falling mass with an impact velocity of 1 m/s. For differing application data, these values can only be used as a reference. The energy absorption depends on the **individual impact surface** and stroke utilization. The longer the load duration the more the reduction in energy absorption (material fatigue).

### Ordering Example

ACE-SLAB \_\_\_\_\_ **SL-300-12-Dxxxx**  
 Material Type \_\_\_\_\_  
 Material Thickness 12.5 mm \_\_\_\_\_  
 Customers Specific Dimension/Shape \_\_\_\_\_  
 (D-Number is assigned by ACE)

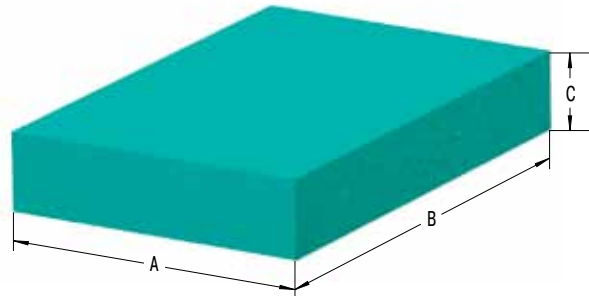

The chosen damping plate should be tested by the customer on the specific application.

### Characteristics of Type SL-300-12

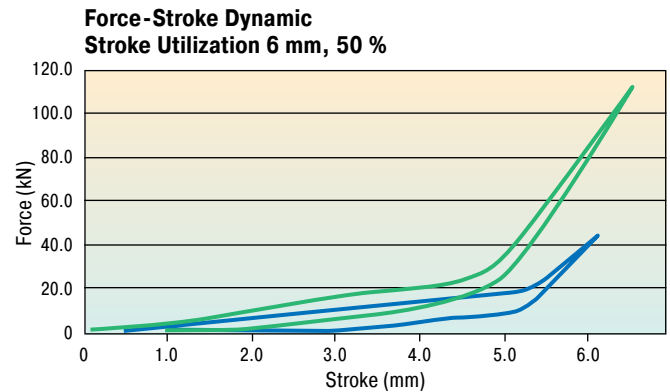
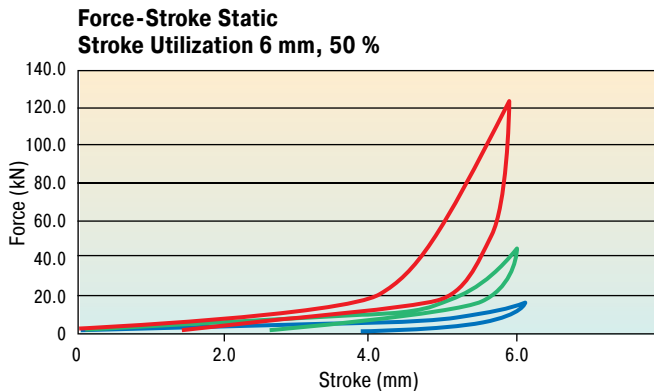
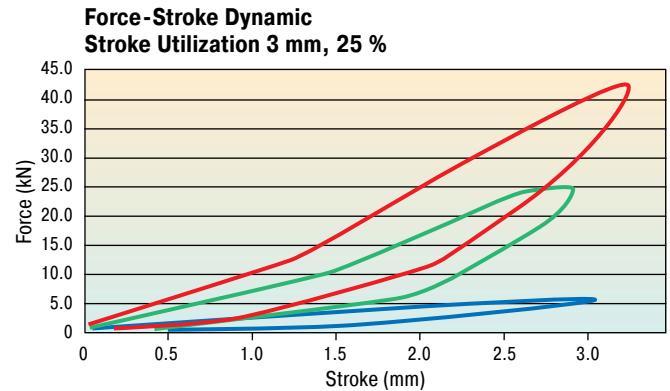
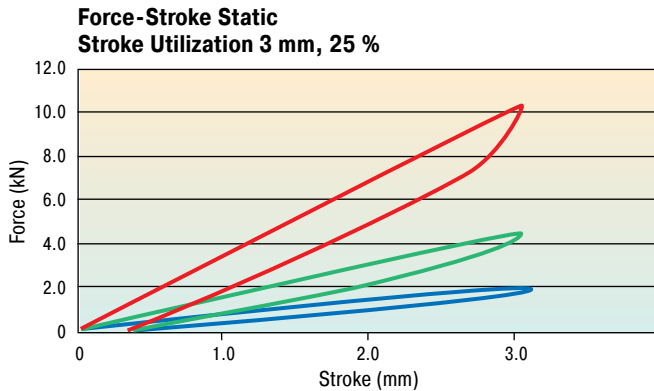

Load data:  
static, between two level plates  
deformation velocity:  
1 % of the plate thickness/sec.

— Area 10 000 mm<sup>2</sup>  
 — Area 5 000 mm<sup>2</sup>  
 — Area 2 500 mm<sup>2</sup>

Load data:  
dynamic, free-falling mass,  
impact velocity:  
about 1 m/s.

### Dimensions and Capacity Chart (Sample Plates MP1 to MP3)

Type	<sup>1</sup> E <sub>3</sub> max. Nm/Cycle	<sup>1</sup> Stroke Utilization mm	A	B	C	Area mm <sup>2</sup>	Density kg/m <sup>3</sup>	Return Time s	Weight kg
SL-300-12-D-MP1	17.0 (85.0)	3 (6)	50	50	12.5	2 500	800	Approx. 2 (3)	0.025
SL-300-12-D-MP2	50.0 (250.0)	3 (6)	70.7	70.7	12.5	5 000	800	Approx. 2 (3)	0.050
SL-300-12-D-MP3	100.0	3 (6)	100	100	12.5	10 000	800	Approx. 2 (3)	0.100

<sup>1</sup> Energy absorption and stroke utilization as well as the illustrated dynamic curve progression refer to a calculated free falling mass with an impact velocity of 1 m/s. For differing application data, these values can only be used as a reference. The energy absorption depends on the individual impact surface and stroke utilization. The longer the load duration the more the reduction in energy absorption (material fatigue).

#### Ordering Example

ACE-SLAB \_\_\_\_\_  
 Material Type \_\_\_\_\_  
 Material Thickness 25 mm \_\_\_\_\_  
 Customers Specific Dimension/Shape \_\_\_\_\_  
 (D-Number is assigned by ACE)

**SL-300-25-Dxxxx**

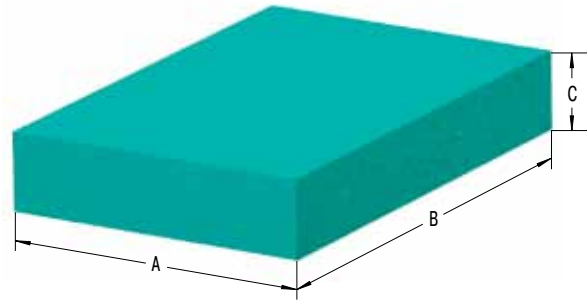

The chosen damping plate should be tested by the customer on the specific application.

#### Characteristics of Type SL-300-25

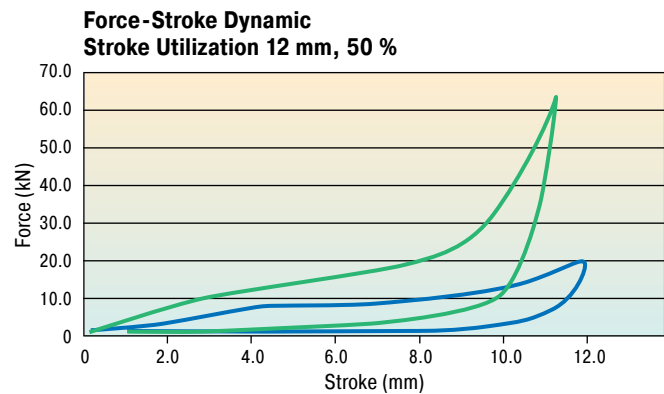
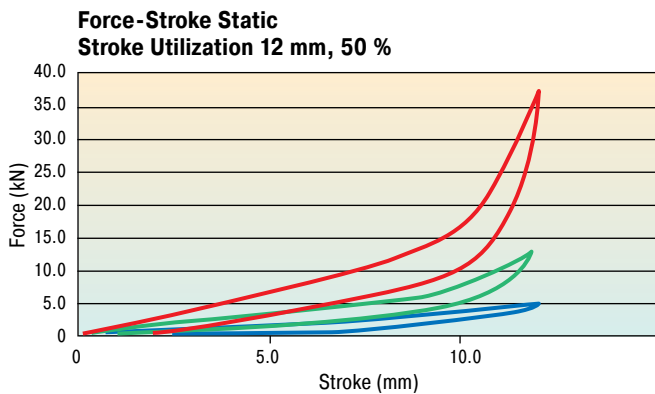
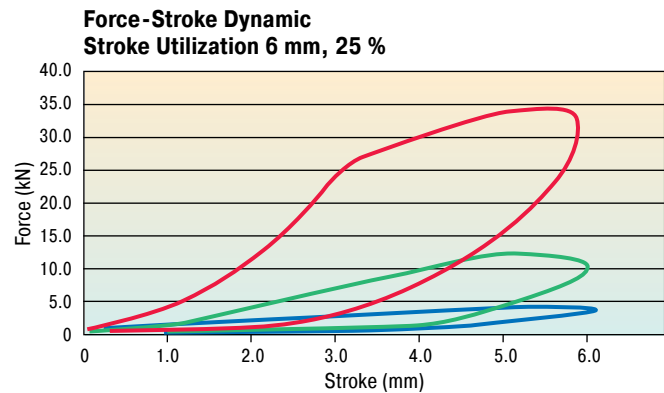
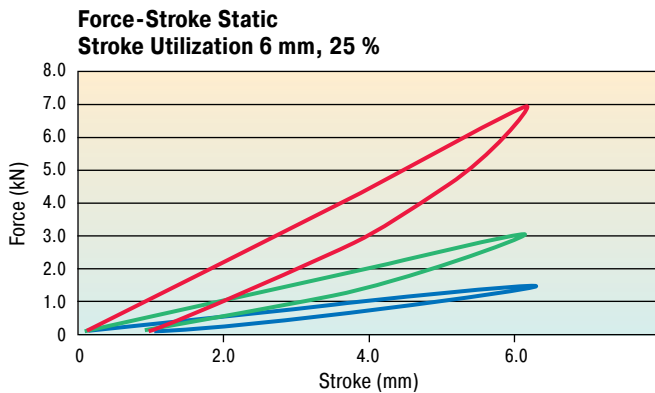

Load data:  
 static, between two level plates  
 deformation velocity:  
 1 % of the plate thickness/sec.

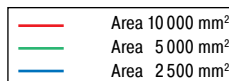

Load data:  
 dynamic, free-falling mass,  
 impact velocity:  
 about 1 m/s.

#### Dimensions and Capacity Chart (Sample Plates MP1 to MP3)

Type	<sup>1</sup> E <sub>3</sub> max. Nm/Cycle	<sup>1</sup> Stroke Utilization mm	A	B	C	Area mm <sup>2</sup>	Density kg/m <sup>3</sup>	Return Time s	Weight kg
SL-300-25-D-MP1	19.5 (90.0)	6 (12)	50	50	25	2500	800	Approx. 3 (4)	0.050
SL-300-25-D-MP2	50.0 (225.0)	6 (12)	70.7	70.7	25	5000	800	Approx. 3 (4)	0.100
SL-300-25-D-MP3	150.0	6 (12)	100	100	25	10000	800	Approx. 3 (4)	0.200

<sup>1</sup> Energy absorption and stroke utilization as well as the illustrated dynamic curve progression refer to a calculated free falling mass with an impact velocity of 1 m/s. For differing application data, these values can only be used as a reference. The energy absorption depends on the **individual impact surface** and stroke utilization. The longer the load duration the more the reduction in energy absorption (material fatigue).



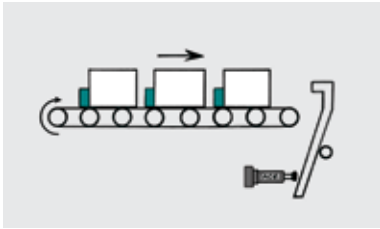

Damping in between Pallets

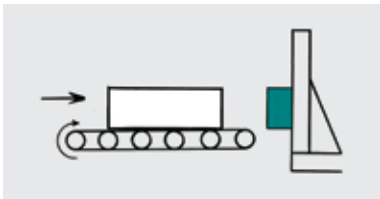

Impact Buffer for Slats, Beams, etc.

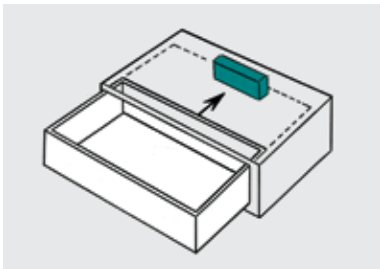

Drawer Damping

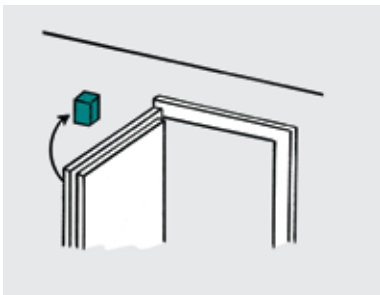

Door Stopper, i.e., for Glass Doors

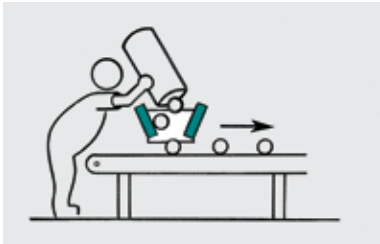

Funnel Tube Lining at Assembly Lines

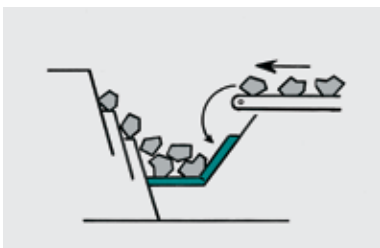

Feed Hopper Lining at Graded Sorter

**ACE-SLAB damping plates** protect man and machine.

At the beginning of the construction phase of a modern processing center at the end position, a 25 kg cable channel collided with force against the housing and produced a deafening noise and mechanical strain on the energy chain. A reliable solution for compliance with the operational parameters was realized with the **SL-030-25-Dxxxx** type ACE-SLAB damping plates even before the milling machine was finished.



Noise reduction

Low-noise energy chain

**ACE-SLAB damping plates** make tire transport safer.

Developed for absorbing the impact of forces, the ACE-SLAB damping plates **SL-030-121-Dxxxx** applied in this tire testing system are ideal for protecting the sliding parts of the machine during quality tests.

The individual customisation of the ring form of the center arm and simple integration into the equipment also support the decision for applying these innovative absorber elements.



With the kind permission of SDS Systemtechnik GmbH, [www.sds-systemtechnik.de](http://www.sds-systemtechnik.de)

Perfectly fitted machine protection

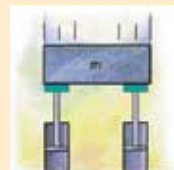

Impact reduction in ring form

**SLAB damping plates** of the **SL-170 to SL-720** are universally applicable elastic PUR materials that are manufactured according to a patented formula and which are used throughout industry. The standard densities of 170 kg/m<sup>3</sup> to 720 kg/m<sup>3</sup> serve as vibration insulation in a wide variety of applications. For specific applications, special designs with specific densities can be manufactured. The static and dynamic product characteristics are precisely defined. The effectiveness of elastic suspension can be calculated in advance. The necessary parameters are shown on a respective checklist.

The static load capacity of standard materials are in the range of:

- SL-170: 0 to 0.011 N/mm<sup>2</sup>
- SL-210: 0 to 0.028 N/mm<sup>2</sup>
- SL-275: 0 to 0.055 N/mm<sup>2</sup>
- SL-450: 0 to 0.15 N/mm<sup>2</sup>
- SL-600: 0 to 0.30 N/mm<sup>2</sup>
- SL-720: 0 to 0.50 N/mm<sup>2</sup>

and for special designs up to 0.8 N/mm<sup>2</sup>.

Unusual and light loads can withstand forces of 5.0 N/mm<sup>2</sup>. This value can reach up to 6 N/mm<sup>2</sup> for special designs.

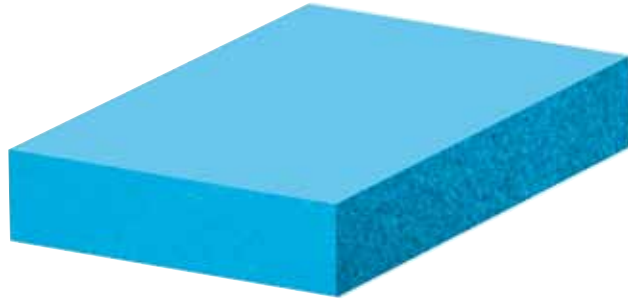

*"Efficiency of the elastic damping can be calculated in advance!"*



**Compression set:** ≤ 5 %, at 50 % of compression, 23 °C, 70 h, 30 min after unloading, according to EN ISO 1856

**Environment:** Resistant against ozone and UV radiation (also see chemical resistancy page 18).

**Material:** Mixed cellular PUR-Elastomer (polyether urethane)

**Standard density:** 170 kg/m<sup>3</sup>, 210 kg/m<sup>3</sup>, 275 kg/m<sup>3</sup>, 450 kg/m<sup>3</sup>, 600 kg/m<sup>3</sup>, 720 kg/m<sup>3</sup>, special designs on request.

**Fire rating:** B2, normally flammable according to DIN 4102

**Operating temperature range:** -30 °C to +70 °C, short-term higher temperature possible.

**Delivery form:** Thickness: 12.5 mm and 25 mm. Rolls: 1.5 m wide, 5.0 m long. Strips: Up to the maximum width and length. Other dimensions (also thickness), colors, shapes and cut-out parts on request.

**Possibilities for cutting:** Water jet cutting, stamping, splitting, sawing, drilling etc.

**Mounting style:** Bonding (see adhesive recommendation page 17), clamps, screws, etc.

**On request:** Available with compact polyurethane wearing surface, shore hardness: 82 shore Sh A.



#### Even load distribution of vibration damping elements are illustrated using the example of a combustion engine

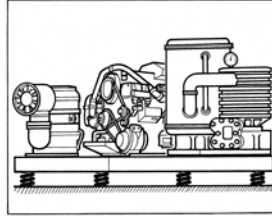
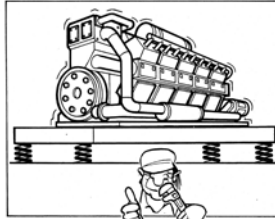
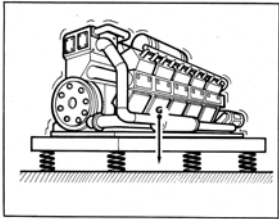
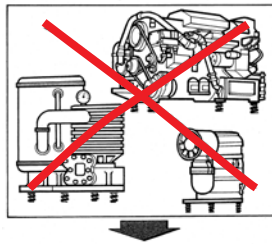
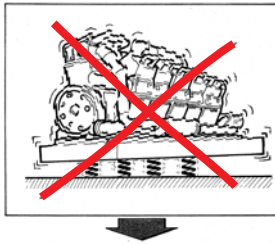
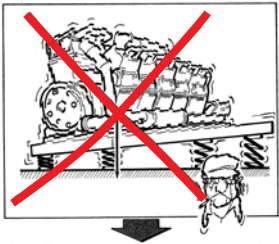

Pay attention to center of gravity

Maximize the bearing's torsional stiffness

Merging of assembly groups (combined elastic bearing)

#### Mounting of individual equipment components illustrated using the example of a pump

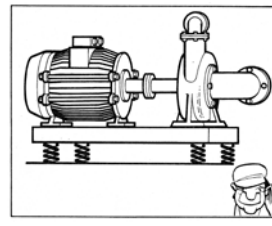
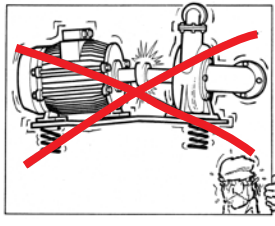
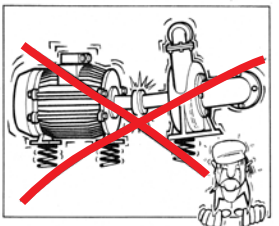

Pay attention to separate flexible mounts of connected equipment components

Pay attention to flexible base plates or machine frames

Use large flex resistant base plates or machine frames

#### Full surface mounted eccentric press

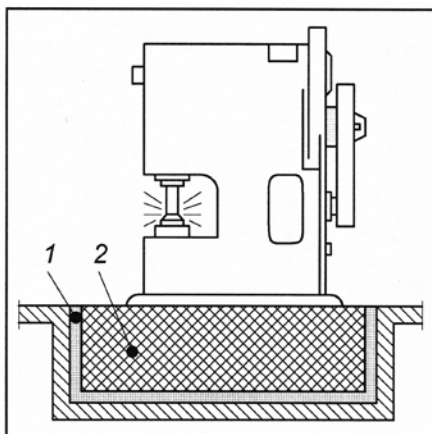

- sufficient base size
- modeling
- assure vibration insulation
- static view: center of gravity, deflection
- maximize torsional stiffness
- dynamic view: forces, torques, amplitude

1 Vibration damping  
2 Concrete base

Source: SUVA, Elastic Bearing of Machines

Machines generate vibrations which are transmitted to the surroundings. They can influence the manufacturing process of other machines and thereby the quality of the products.

Vibrations disrupt the location and the environment and cause damage to buildings. SLAB polyurethane elastomer is a material that effectively reduces vibration and structure-borne noise. Depending on the requirements, SLABs are available in different densities, thicknesses and dimensions.

SLAB damping plates are used to insulate vibrations for:

- Machine tools
- Textile machinery
- Air conditioning and ventilating machines
- Crane rails
- Hydraulic crushers
- Presses / stamping machines etc.

Potential for direct bearing support on SLAB damping plates:

#### Full surface mount



#### Strip bearings



#### Discrete bearings

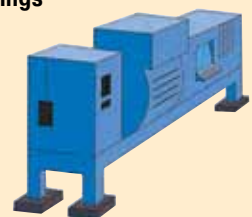

### Ordering Example

ACE-SLAB \_\_\_\_\_  
 Material Type \_\_\_\_\_  
 Material Thickness 12.5 mm \_\_\_\_\_  
 Customers Specific Dimension/Shape \_\_\_\_\_  
 (F-Number is assigned by ACE)

SL-170-12-Fxxxx

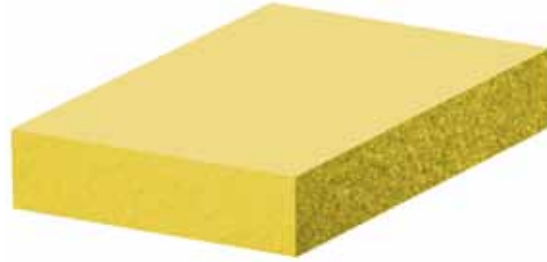

### Recommendation for Elastic Bearing

Static application range (static loads): 0 to 0.011 N/mm<sup>2</sup>  
 Dynamic range (static and dynamic loads): 0 to 0.016 N/mm<sup>2</sup>  
 Peak loads (rare, brief loads): up to 0.5 N/mm<sup>2</sup>

## Characteristics

### Spring Characteristics<sup>1</sup>

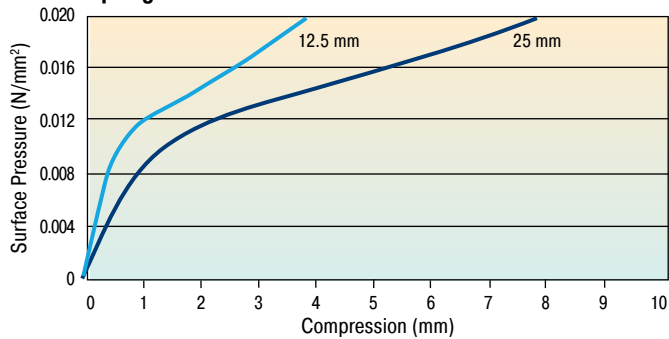

### Elasticity Module<sup>2</sup>

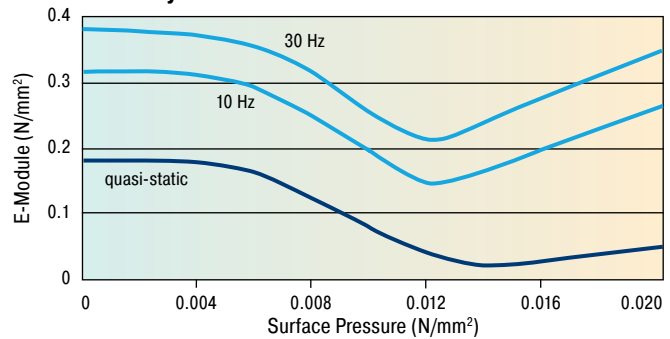

### Natural Frequency<sup>3</sup>

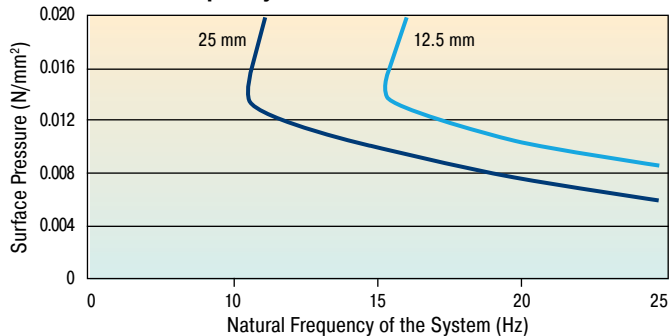

<sup>1</sup> Quasi-static spring characteristic with a load speed of 0.0011 N/mm<sup>2</sup>/s  
 Tests between the level and plane-parallel steel plates, recording the 3rd load, testing at room temperature, form factor q = 3

<sup>2</sup> Load-dependence of static and dynamic E-modules  
 Quasi-static E-module as a tangent module from the spring characteristic. Dynamic E-module from the sinus-shaped stimulation with a vibration wave of 100 dBv re. 5 · 10<sup>-8</sup> m/s (corresponding with a vibration width of 0.22 mm at 10 Hz and 0.08 mm at 30 Hz). Measurement based on DIN 53513, form factor q = 3

<sup>3</sup> Natural frequencies of a vibration-capable system with a degree of freedom, consisting of a rigid mass and an elastic bearing made of SL-170 on a rigid base, form factor q = 3

## Technical Data

**Characteristics:** Elastic PUR material with spring/absorber properties

**Delivery form:** Thickness: 12.5 mm and 25 mm. Rolls: 1.5 m wide and 5.0 m long. Strips: max. 1.5 m wide, 5 m long. Other dimensions (also thickness), colors, shapes and cut-out parts upon request.

**Material:** Mixed-cell polyetherurethane

**Standard color:** Yellow

### Physical Characteristics

		Test Procedure	Comment
Density	170 kg/m <sup>3</sup>		
Mechanical loss factor	η = 0.25	DIN 53513*	dependent on frequency, load and amplitude
Impact resilience	45 %	DIN 53573	
Static modulus of rigidity	0.03 N/mm <sup>2</sup>	DIN ISO 1827*	with preload of 0.011 N/mm <sup>2</sup>
Dynamic modulus of rigidity	0.10 N/mm <sup>2</sup>	DIN ISO 1827*	with preload of 0.011 N/mm <sup>2</sup> , 10 Hz
Tensile strength	0.3 N/mm <sup>2</sup>	EN ISO 527-3/5/100*	minimum value
Elongation at break	300 %	EN ISO 527-3/5/100*	minimum value
Friction value (steel)	μ <sub>S</sub> = 0.5		dry
Friction value (concrete)	μ <sub>B</sub> = 0.7		dry
Abrasion	1400 mm <sup>3</sup>	DIN 53516	2.5 N load, lower membrane

\* Measurement based on the respective norm

### Ordering Example

ACE-SLAB \_\_\_\_\_  
 Material Type \_\_\_\_\_  
 Material Thickness 12.5 mm \_\_\_\_\_  
 Customers Specific Dimension/Shape \_\_\_\_\_  
 (F-Number is assigned by ACE)

**SL-210-12-Fxxxx**

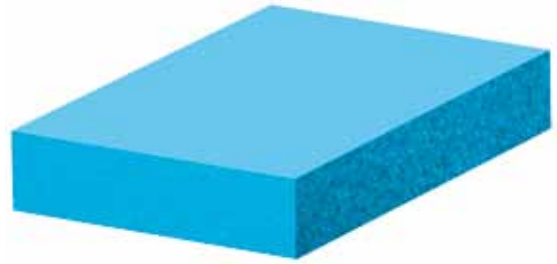

### Recommendation for Elastic Bearing

Static application range (static loads): 0 to 0.028 N/mm<sup>2</sup>  
 Dynamic range (static and dynamic loads): 0 to 0.042 N/mm<sup>2</sup>  
 Peak loads (rare, brief loads): up to 1.0 N/mm<sup>2</sup>

## Characteristics

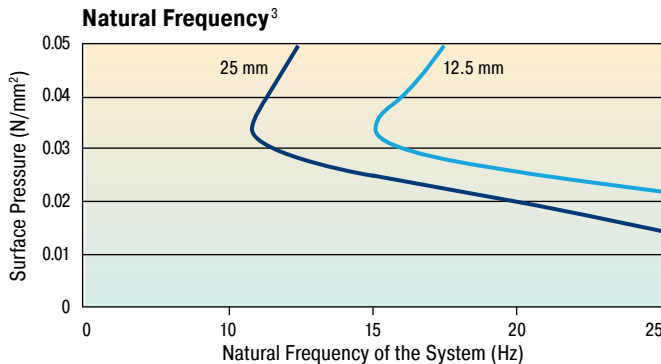
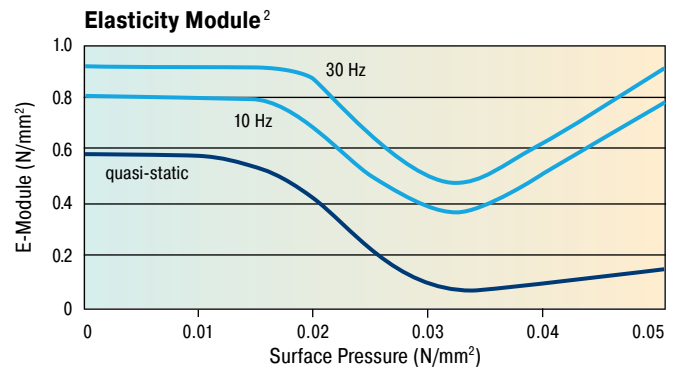
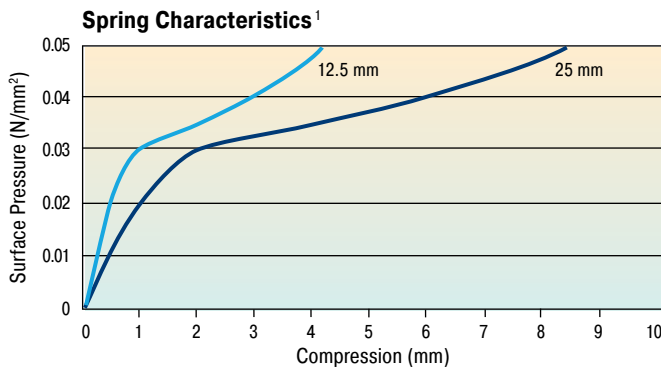

<sup>1</sup> Quasi-static spring characteristic with a load speed of 0.0028 N/mm<sup>2</sup>/s

Tests between the level and plane-parallel steel plates, recording the 3rd load, testing at room temperature, form factor q = 3

<sup>2</sup> Load-dependence of static and dynamic E-modules

Quasi-static E-module as a tangent module from the spring characteristic. Dynamic E-module from the sinus-shaped stimulation with a vibration wave of 100 dBv re. 5 · 10<sup>-8</sup> m/s (corresponding with a vibration width of 0.22 mm at 10 Hz and 0.08 mm at 30 Hz). Measurement based on DIN 53513, form factor q = 3

<sup>3</sup> Natural frequencies of a vibration-capable system with a degree of freedom,

consisting of a rigid mass and an elastic bearing made of SL-210 on a rigid base, form factor q = 3

## Technical Data

**Characteristics:** Elastic PUR material with spring/absorber properties

**Delivery form:** Thickness: 12.5 mm and 25 mm. Rolls: 1.5 m wide and 5.0 m long. Strips: max. 1.5 m wide, 5 m long. Other dimensions (also thickness), colors, shapes and cut-out parts upon request.

**Material:** Mixed-cell polyetherurethane

**Standard color:** Blue

### Physical Characteristics

		Test Procedure	Comment
Density	210 kg/m <sup>3</sup>		
Mechanical loss factor	η = 0.21	DIN 53513*	dependent on frequency, load and amplitude
Impact resilience	45 %	DIN 53573	
Static modulus of rigidity	0.07 N/mm <sup>2</sup>	DIN ISO 1827*	with preload of 0.028 N/mm <sup>2</sup>
Dynamic modulus of rigidity	0.15 N/mm <sup>2</sup>	DIN ISO 1827*	with preload of 0.028 N/mm <sup>2</sup> , 10 Hz
Tensile strength	0.4 N/mm <sup>2</sup>	EN ISO 527-3/5/100*	minimum value
Elongation at break	250 %	EN ISO 527-3/5/100*	minimum value
Friction value (steel)	μ <sub>S</sub> = 0.5		dry
Friction value (concrete)	μ <sub>B</sub> = 0.7		dry
Abrasion	1300 mm <sup>3</sup>	DIN 53516	5 N load, lower membrane

\* Measurement based on the respective norm

### Ordering Example

ACE-SLAB \_\_\_\_\_  
 Material Type \_\_\_\_\_  
 Material Thickness 12.5 mm \_\_\_\_\_  
 Customers Specific Dimension/Shape \_\_\_\_\_  
 (F-Number is assigned by ACE)

SL-275-12-Fxxxx

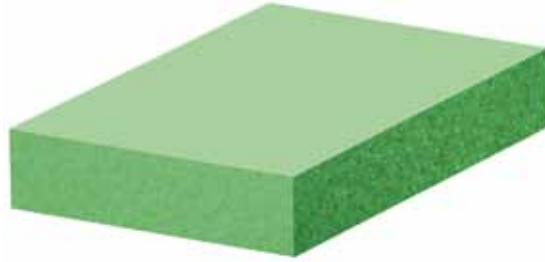

### Recommendation for Elastic Bearing

Static application range (static loads): 0 to 0.055 N/mm<sup>2</sup>  
 Dynamic range (static and dynamic loads): 0 to 0.085 N/mm<sup>2</sup>  
 Peak loads (rare, brief loads): up to 2.0 N/mm<sup>2</sup>

## Characteristics

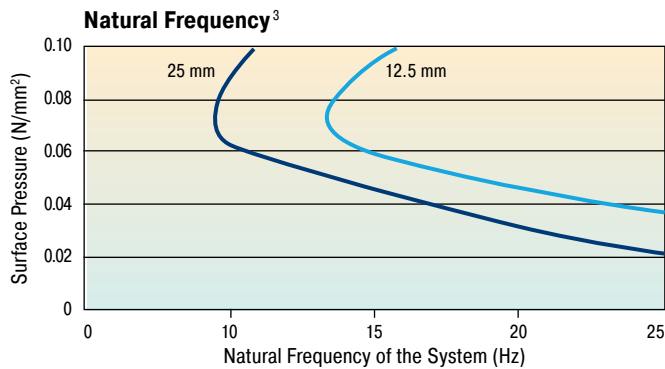
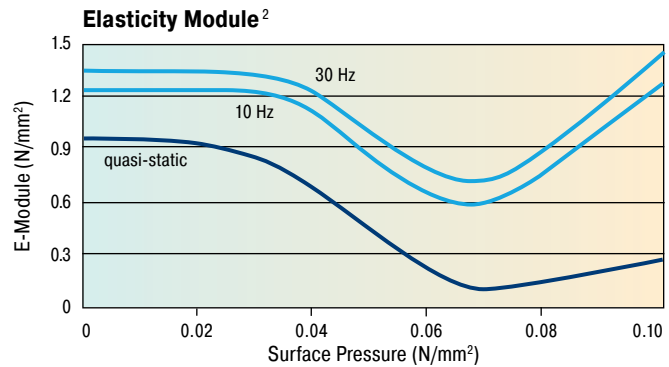
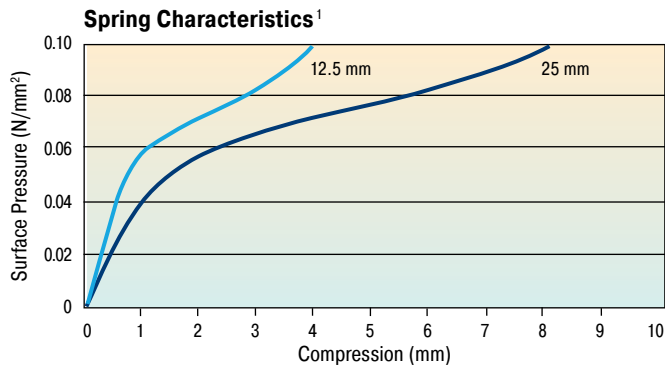

<sup>1</sup> Quasi-static spring characteristic with a load speed of 0.0055 N/mm<sup>2</sup>/s  
 Tests between the level and plane-parallel steel plates, recording the 3rd load, testing at room temperature, form factor q = 3

<sup>2</sup> Load-dependence of static and dynamic E-modules  
 Quasi-static E-module as a tangent module from the spring characteristic. Dynamic E-module from the sinus-shaped stimulation with a vibration wave of 100 dBv re. 5 · 10<sup>-8</sup> m/s (corresponding with a vibration width of 0.22 mm at 10 Hz and 0.08 mm at 30 Hz). Measurement based on DIN 53513, form factor q = 3

<sup>3</sup> Natural frequencies of a vibration-capable system with a degree of freedom, consisting of a rigid mass and an elastic bearing made of SL-275 on a rigid base, form factor q = 3

## Technical Data

**Characteristics:** Elastic PUR material with spring/absorber properties

**Material:** Mixed-cell polyetherurethane

**Delivery form:** Thickness: 12.5 mm and 25 mm. Rolls: 1.5 m wide and 5.0 m long. Strips: max. 1.5 m wide, 5 m long. Other dimensions (also thickness), colors, shapes and cut-out parts upon request.

**Standard color:** Green

### Physical Characteristics

		Test Procedure	Comment
Density	275 kg/m <sup>3</sup>		
Mechanical loss factor	η = 0.17	DIN 53513*	dependent on frequency, load and amplitude
Impact resilience	55 %	DIN 53573	
Static modulus of rigidity	0.13 N/mm <sup>2</sup>	DIN ISO 1827*	with preload of 0.055 N/mm <sup>2</sup>
Dynamic modulus of rigidity	0.26 N/mm <sup>2</sup>	DIN ISO 1827*	with preload of 0.055 N/mm <sup>2</sup> , 10 Hz
Tensile strength	0.6 N/mm <sup>2</sup>	EN ISO 527-3/5/100*	minimum value
Elongation at break	250 %	EN ISO 527-3/5/100*	minimum value
Friction value (steel)	μ <sub>S</sub> = 0.5		dry
Friction value (concrete)	μ <sub>B</sub> = 0.7		dry
Abrasion	1100 mm <sup>3</sup>	DIN 53516	7.5 N load, lower membrane

\* Measurement based on the respective norm

### Ordering Example

ACE-SLAB \_\_\_\_\_  
 Material Type \_\_\_\_\_  
 Material Thickness 12.5 mm \_\_\_\_\_  
 Customers Specific Dimension/Shape \_\_\_\_\_  
 (F-Number is assigned by ACE)

SL-450-12-Fxxxx



### Recommendation for Elastic Bearing

Static application range (static loads): 0 to 0.15 N/mm<sup>2</sup>  
 Dynamic range (static and dynamic loads): 0 to 0.25 N/mm<sup>2</sup>  
 Peak loads (rare, brief loads): up to 2.0 N/mm<sup>2</sup>

## Characteristics

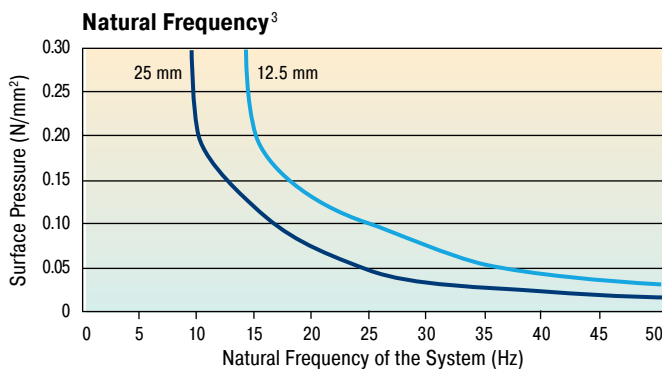
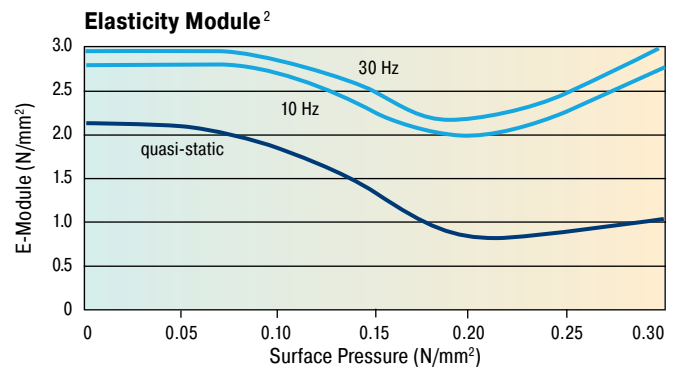
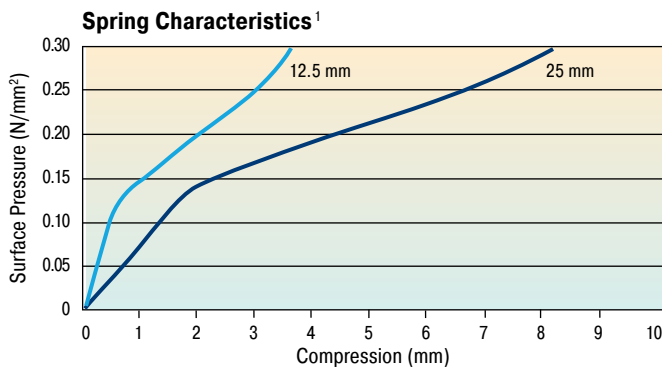

<sup>1</sup> Quasi-static spring characteristic with a load speed of 0.015 N/mm<sup>2</sup>/s  
 Tests between the level and plane-parallel steel plates, recording the 3rd load, testing at room temperature, form factor q = 3

<sup>2</sup> Load-dependence of static and dynamic E-modules  
 Quasi-static E-module as a tangent module from the spring characteristic. Dynamic E-module from the sinus-shaped stimulation with a vibration wave of 100 dBv re. 5 · 10<sup>-8</sup> m/s (corresponding with a vibration width of 0.22 mm at 10 Hz and 0.08 mm at 30 Hz). Measurement based on DIN 53513, form factor q = 3

<sup>3</sup> Natural frequencies of a vibration-capable system with a degree of freedom, consisting of a rigid mass and an elastic bearing made of SL-450 on a rigid base, form factor q = 3

## Technical Data

**Characteristics:** Elastic PUR material with spring/absorber properties

**Delivery form:** Thickness: 12.5 mm and 25 mm. Rolls: 1.5 m wide and 5.0 m long. Strips: max. 1.5 m wide, 5 m long. Other dimensions (also thickness), colors, shapes and cut-out parts upon request.

**Material:** Mixed-cell polyetherurethane

**Standard color:** Orange

### Physical Characteristics

		Test Procedure	Comment
Density	450 kg/m <sup>3</sup>		
Mechanical loss factor	η = 0.17	DIN 53513*	dependent on frequency, load and amplitude
Impact resilience	55 %	DIN 53573	
Static modulus of rigidity	0.48 N/mm <sup>2</sup>	DIN ISO 1827*	with preload of 0.15 N/mm <sup>2</sup>
Dynamic modulus of rigidity	0.76 N/mm <sup>2</sup>	DIN ISO 1827*	with preload of 0.15 N/mm <sup>2</sup> , 10 Hz
Tensile strength	1,5 N/mm <sup>2</sup>	EN ISO 527-3/5/100*	minimum value
Elongation at break	300 %	EN ISO 527-3/5/100*	minimum value
Friction value (steel)	μ <sub>s</sub> = 0.5		dry
Friction value (concrete)	μ <sub>s</sub> = 0.7		dry
Abrasion	1150 mm <sup>3</sup>	DIN 53516	10 N load, lower membrane

\* Measurement based on the respective norm

### Ordering Example

ACE-SLAB \_\_\_\_\_  
 Material Type \_\_\_\_\_  
 Material Thickness 12.5 mm \_\_\_\_\_  
 Customers Specific Dimension/Shape \_\_\_\_\_  
 (F-Number is assigned by ACE)

SL-600-12-Fxxxx

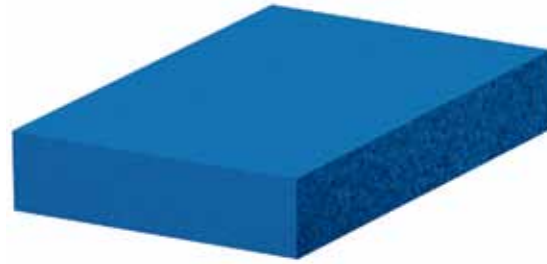

### Recommendation for Elastic Bearing

Static application range (static loads): 0 to 0.30 N/mm<sup>2</sup>  
 Dynamic range (static and dynamic loads): 0 to 0.45 N/mm<sup>2</sup>  
 Peak loads (rare, brief loads): up to 3.0 N/mm<sup>2</sup>

## Characteristics

### Spring Characteristics<sup>1</sup>

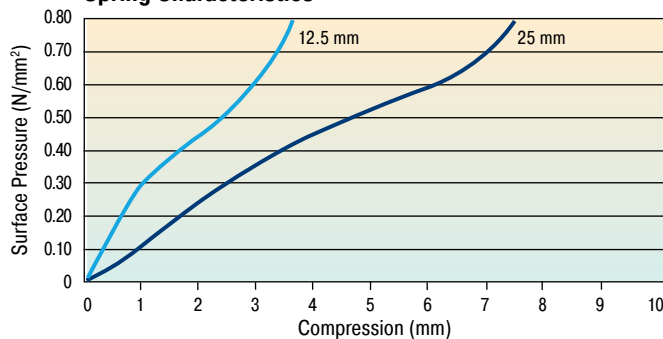

### Elasticity Module<sup>2</sup>

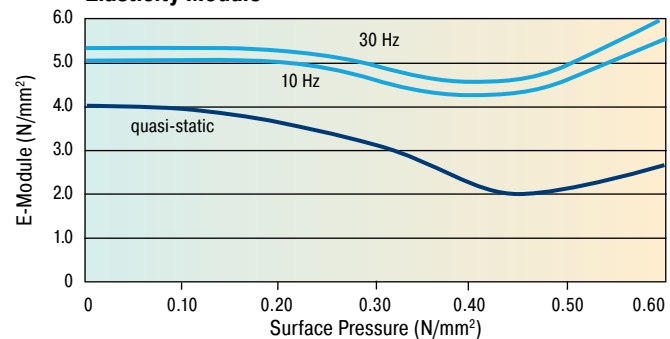

### Natural Frequency<sup>3</sup>

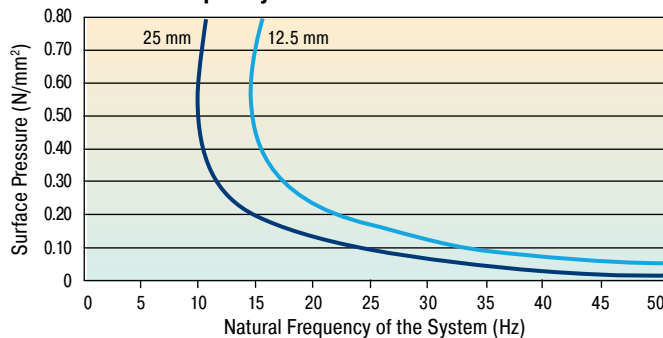

<sup>1</sup> Quasi-static spring characteristic with a load speed of 0.03 N/mm<sup>2</sup>/s  
 Tests between the level and plane-parallel steel plates, recording the 3rd load, testing at room temperature, form factor q = 3

<sup>2</sup> Load-dependence of static and dynamic E-modules  
 Quasi-static E-module as a tangent module from the spring characteristic. Dynamic E-module from the sinus-shaped stimulation with a vibration wave of 100 dBv re. 5 · 10<sup>-8</sup> m/s (corresponding with a vibration width of 0.22 mm at 10 Hz and 0.08 mm at 30 Hz). Measurement based on DIN 53513, form factor q = 3

<sup>3</sup> Natural frequencies of a vibration-capable system with a degree of freedom, consisting of a rigid mass and an elastic bearing made of SL-600 on a rigid base, form factor q = 3

## Technical Data

**Characteristics:** Elastic PUR material with spring/absorber properties

**Material:** Mixed-cell polyetherurethane

**Delivery form:** Thickness: 12.5 mm and 25 mm. Rolls: 1.5 m wide and 5.0 m long. Strips: max. 1.5 m wide, 5 m long. Other dimensions (also thickness), colors, shapes and cut-out parts upon request.

**Standard color:** Blue

### Physical Characteristics

		Test Procedure	Comment
Density	600 kg/m <sup>3</sup>		
Mechanical loss factor	η = 0.12	DIN 53513*	dependent on frequency, load and amplitude
Impact resilience	60 %	DIN 53512	
Static modulus of rigidity	0.8 N/mm <sup>2</sup>	DIN ISO 1827*	with preload of 0.30 N/mm <sup>2</sup>
Dynamic modulus of rigidity	1.2 N/mm <sup>2</sup>	DIN ISO 1827*	with preload of 0.30 N/mm <sup>2</sup> , 10 Hz
Tensile strength	2 N/mm <sup>2</sup>	EN ISO 527-3/5/100*	minimum value
Elongation at break	300 %	EN ISO 527-3/5/100*	minimum value
Friction value (steel)	μ <sub>S</sub> = 0.5		dry
Friction value (concrete)	μ <sub>B</sub> = 0.7		dry
Abrasion	700 mm <sup>3</sup>	DIN 53516	10 N load, lower membrane

\* Measurement based on the respective norm



### Ordering Example

ACE-SLAB \_\_\_\_\_  
 Material Type \_\_\_\_\_  
 Material Thickness 12.5 mm \_\_\_\_\_  
 Customers Specific Dimension/Shape \_\_\_\_\_  
 (F-Number is assigned by ACE)

SL-720-12-Fxxxx



### Recommendation for Elastic Bearing

Static application range (static loads): 0 to 0.50 N/mm<sup>2</sup>  
 Dynamic range (static and dynamic loads): 0 to 0.75 N/mm<sup>2</sup>  
 Peak loads (rare, brief loads): up to 5.0 N/mm<sup>2</sup>

## Characteristics

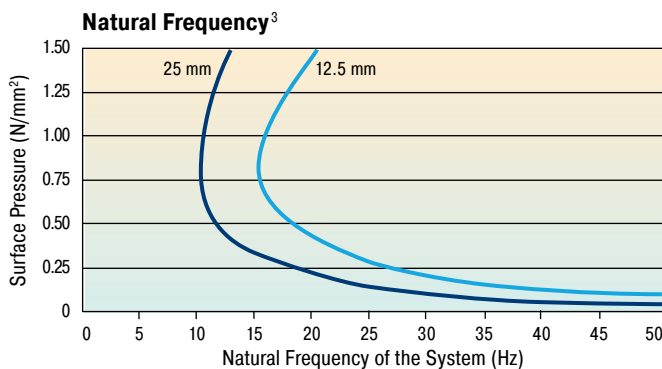
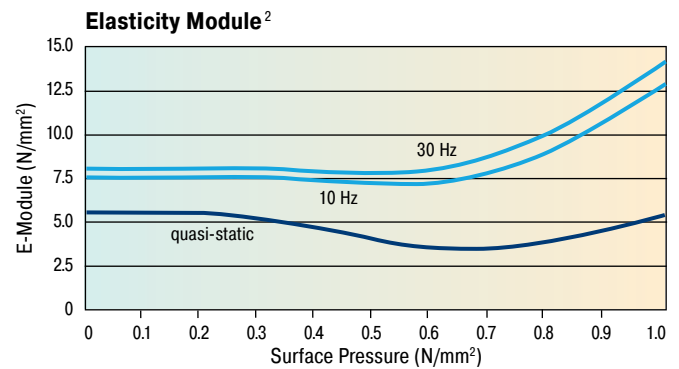
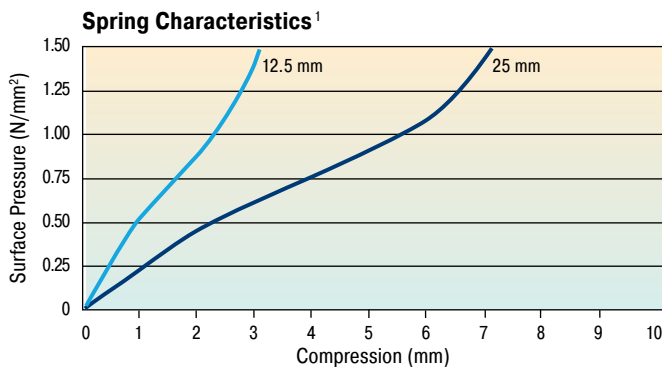

<sup>1</sup> Quasi-static spring characteristic with a load speed of 0.05 N/mm<sup>2</sup>/s  
 Tests between the level and plane-parallel steel plates, recording the 3rd load, testing at room temperature, form factor q = 3

<sup>2</sup> Load-dependence of static and dynamic E-modules  
 Quasi-static E-module as a tangent module from the spring characteristic. Dynamic E-module from the sinus-shaped stimulation with a vibration wave of 100 dBv re. 5 · 10<sup>-8</sup> m/s (corresponding with a vibration width of 0.22 mm at 10 Hz and 0.08 mm at 30 Hz). Measurement based on DIN 53513, form factor q = 3

<sup>3</sup> Natural frequencies of a vibration-capable system with a degree of freedom, consisting of a rigid mass and an elastic bearing made of SL-720 on a rigid base, form factor q = 3

## Technical Data

**Characteristics:** Elastic PUR material with spring/absorber properties

**Delivery form:** Thickness: 12.5 mm and 25 mm. Rolls: 1.5 m wide and 5.0 m long. Strips: max. 1.5 m wide, 5 m long. Other dimensions (also thickness), colors, shapes and cut-out parts upon request.

**Material:** Mixed-cell polyetherurethane

**Standard color:** Black

### Physical Characteristics

		Test Procedure	Comment
Density	720 kg/m <sup>3</sup>		
Mechanical loss factor	η = 0.12	DIN 53513*	dependent on frequency, load and amplitude
Impact resilience	60 %	DIN 53512	
Static modulus of rigidity	1 N/mm <sup>2</sup>	DIN ISO 1827*	with preload of 0.50 N/mm <sup>2</sup>
Dynamic modulus of rigidity	1.5 N/mm <sup>2</sup>	DIN ISO 1827*	with preload of 0.50 N/mm <sup>2</sup> , 10 Hz
Tensile strength	3 N/mm <sup>2</sup>	EN ISO 527-3/5/100*	minimum value
Elongation at break	300 %	EN ISO 527-3/5/100*	minimum value
Friction value (steel)	μ <sub>s</sub> = 0.5		dry
Friction value (concrete)	μ <sub>s</sub> = 0.7		dry
Abrasion	350 mm <sup>3</sup>	DIN 53516	10 N load, lower membrane

\* Measurement based on the respective norm

## Bonding of Polyurethane (PUR) Elastomers

Cellular and compact parts of polyurethane (PUR) elastomers SLAB damping plates can be bonded according to the following recommendations. If treatment instructions are followed, the strengths of the bonded joint can be equivalent to the elastomer material itself.

### 1. General Information

To achieve the required bonding strength it is necessary to ensure the correct adhesive is chosen for each individual application.

**Contact bonding material:** Thin adhesive film, with little filling of the gaps. Correcting or moving of the areas covered with bonding material is no longer possible after the first contact is made (contact effect).

Once a bonding is separated, the bonding process must be renewed.

Please note that creases, ripples or blisters cannot be straightened once the contact is made.

**Hardening bonding material:** (As thin as possible) the film of glue fills the joint. The gluing can be done after the edges are brought together.

### 2. Preparation

The preparation of bonding surfaces is of significant importance for the bonding strength. The surfaces must be adapted to each other and available in plain, clean form.

**Careful removal of:** Adhesive remnants, oil, fat, separating agents, dirt, dust, scales, molding layers, protective coating, finish, paint, sweat etc.

**Mechanical support:** Stripping, brushing, scraping, grinding, sandblasting.

**Chemical support:** Degreasing (washing off with grease remover), etching, priming; pay attention to chemical resistancy on page 18.

In general, SLAB damping plates in sheet form can be bonded without pretreatment. Molded parts, with or without special skin, have to be cleaned from left-over separating agents, if necessary by grinding. When bonding with other materials like plastic, wood, metal or concrete, mechanical and/or chemical additives have to be used.

The adhesive has to be prepared according to the formula, observing the manufacturer's recommendations. The adhesive film is also to be carefully applied pursuant to these details. (Tools: brush, spatula, adhesive spreader, airless spray gun).

**Contact bonding material:** Apply the non-gap-filling adhesive film to both bonding surfaces – the thinner, the better. To close the pores of low density materials, two layers may be necessary.

**Hardening bonding material:** Apply evenly. Possible irregularities can be compensated by the film thickness.

### 3. Bonding

When using contact bonding material, the flash off time has to be kept in mind. Especially, with systems containing water instead of usual solvents, the adhesive film must be as dry as possible in order to pass the 'finger test' – no marks appear when touching the adhesive surface. When using hardening bonding material, the parts have to be joined immediately after applying the bonding material.

### 4. Pressing

**Contact bonding material:** Contact pressure up to 0.5 N/mm<sup>2</sup>

**Hardening bonding material:** Fix firmly

It is important to carefully follow the manufacturer's instructions with regard to processing temperature, hardening time and earliest possible loading.

### 5. Selection of Approved Bonding Materials

For additional information on the variety of materials that can be bonded together as well as the numerous suitable bonding agents, please refer to the information available from Sika Corporation.

Sika Corporation  
201 Polito Avenue  
Lyndhurst, NJ 07071  
United States of America  
Phone: 1-201-933-8800  
Fax: 1-201-804-1076  
Internet: <http://usa.sika.com>

Sika Sarnafil  
100 Dan Road  
Canton, MA 02021  
United States of America  
Phone: 1-781-828-5400  
Fax: 1-781-828-5365  
Internet: <http://usa.sarnafil.sika.com>

### Test (following DIN 53428)

Exposure time of the medium: 6 weeks at room temperature, but for concentrated acids and bases as well as solvents: 7 days at room temperature

### Evaluation Criteria

Changing of tensile strength and elongation of break (dry samples), change in volume

### Evaluation Standard

- 1 Excellent resistance,**  
change in characteristics < 10 %
- 2 Good resistance,**  
change in characteristics between 10 % and 20 %
- 3 Conditional resistance,**  
change in characteristics partly above 20 %
- 4 Not resistant,**  
change in characteristics all above 20 %

All information is based on our current knowledge and experiences. We reserve the rights for changes towards product refinement.

### Chemical Resistance

	SL-030 to SL-300	SL-170 to SL-720		SL-030 to SL-300	SL-170 to SL-720
<b>Water/Watery Solutions</b>			<b>Acids and Bases</b>		
Water	1	1	Formic acid 5 %	3	3
Iron(III) chloride 10 %	1	1	Acetic acid 5 %	2	2
Sodium carbonate 10 %	1	1	Phosphoric acid 5 %	1	1
Sodium chlorate 10 %	1	1	Nitic acid 5 %	4	4
Sodium chloride 10 %	1	1	Hydrochloric acid 5 %	1	1
Sodium nitrate 10 %	1	1	Sulphuric acid 5 %	1	1
Tensides (div.)	1	1	Ammonia solution 5 %	1	1
Hydrogen peroxide 3 %	1	1	Caustic potash solution 5 %	1	1
Laitance	1	1	Caustic soda solution 5 %	1	1
<b>Oils and Greases</b>			<b>Solvents</b>		
ASTM Oil No. 1	1	1	Acetone	4	4
ASTM Oil No. 3	1	2	Diesel/Fuel oil	2	2
Laitance	2	2	Carburetor fuel/Benzine	3	3
Hydraulic oils	depends on consistency/additives		Glycerin	1	1
Motor oil	1	1	Glycols	1-2	2
Formwork oil	1	1	Cleaning solvents/Hexane	1	2
High performance grease	1-2	3	Methanol	3	4
Railroad switch lubricant	1-2	1-2	Aromatic hydrocarbons	4	4
			<b>Other Factors</b>		
			Hydrolysis *	1	1
			Ozone	1	1
			UV radiation and weathering	1-2	1-2
			Biological resistance	1	1

\* 28 days, 70 °C, 95 % relative humidity

### SLAB Sample Kits for Shock Absorption

Sample Kit	Includes 1 each Part Number	Dimensions mm
<b>SL-030-12</b>	<b>250-0800</b>	
	SL-030-12-D-MP1	50 x 50 x 12.5
	SL-030-12-D-MP2	70.7 x 70.7 x 12.5
	SL-030-12-D-MP3	100 x 100 x 12.5
<b>SL-030-25</b>	<b>250-0801</b>	
	SL-030-25-D-MP1	50 x 50 x 25
	SL-030-25-D-MP2	70.7 x 70.7 x 25
	SL-030-25-D-MP3	100 x 100 x 25
<b>SL-100-12</b>	<b>250-0802</b>	
	SL-100-12-D-MP1	<b>50 x 50 x 12.5</b>
	SL-100-12-D-MP2	70.7 x 70.7 x 12.5
	SL-100-12-D-MP3	100 x 100 x 12.5
<b>SL-100-25</b>	<b>250-0803</b>	
	SL-100-25-D-MP1	50 x 50 x 25
	SL-100-25-D-MP2	70.7 x 70.7 x 25
	SL-100-25-D-MP3	100 x 100 x 25
<b>SL-300-12</b>	<b>250-0804</b>	
	SL-300-12-D-MP1	50 x 50 x 12.5
	SL-300-12-D-MP2	70.7 x 70.7 x 12.5
	SL-300-12-D-MP3	100 x 100 x 12.5
<b>SL-300-25</b>	<b>250-0805</b>	
	SL-300-25-D-MP1	50 x 50 x 25
	SL-300-25-D-MP2	70.7 x 70.7 x 25
	SL-300-25-D-MP3	100 x 100 x 25

### SLAB Sample Kits for Vibration Damping

Sample Kit	Includes 1 each Part Number	Dimensions mm
<b>SL-170-12/25</b>	<b>250-0806</b>	
	SL-170-12-F-MP4	220 x 150 x 12.5
	SL-170-25-F-MP4	220 x 150 x 25
<b>SL-210-12/25</b>	<b>250-0807</b>	
	SL-210-12-F-MP4	220 x 150 x 12.5
	SL-210-25-F-MP4	220 x 150 x 25
<b>SL-275-12/25</b>	<b>250-0808</b>	
	SL-275-12-F-MP4	220 x 150 x 12.5
	SL-275-25-F-MP4	220 x 150 x 25
<b>SL-450-12/25</b>	<b>250-0809</b>	
	SL-450-12-F-MP4	220 x 150 x 12.5
	SL-450-25-F-MP4	220 x 150 x 25
<b>SL-600-12/25</b>	<b>250-0810</b>	
	SL-600-12-F-MP4	220 x 150 x 12.5
	SL-600-25-F-MP4	220 x 150 x 25
<b>SL-720-12/25</b>	<b>250-0811</b>	
	SL-720-12-F-MP4	220 x 150 x 12.5
	SL-720-25-F-MP4	220 x 150 x 25

Thickness: 12.5 and 25 mm  
Consult your ACE Controls distributor or ACE directly for price and availability.



**In order to help expedite your application, please fill out the information on this page and forward to the attention of... ACE Applications Engineering at fax number 248-476-2470, or scan and e-mail to shocks@acecontrols.com**

**1. Description of Application**

- a) Description of your application in key words – the kind of machine/device that needs insulation  
.....
- b) Machine design (possibly data sheet with information about loads, installation drawing)  
.....
- c) Static and dynamic machine loads (do these operate off-center?)  
.....
- d) Mounting with foundation:  
What dimensions are available? Is sideways support necessary? length \_\_\_\_\_ mm, width \_\_\_\_\_ mm, height \_\_\_\_\_ mm  
yes            no
- e) Mounting without foundation:  
Which machine mount is present (machine stands, U-profile mount. etc.) contact area \_\_\_\_\_ mm  
number of contact areas \_\_\_\_\_
- f) Environmental requirements air humidity \_\_\_\_\_ %, temperature \_\_\_\_\_ °C,  
liquids/foreign matter \_\_\_\_\_
- g) Required product life  
.....
- h) Safety element: yes            no

**2. Physical Dimensions**

- a) Measurements and weight of the machine mass \_\_\_\_\_ kg
  - b) Center of gravity concentric            excentric            (sketch)
  - c) Operation of the machine, e.g., frequencies or revolutions per minute (exciter frequency) \_\_\_\_\_ Hz            \_\_\_\_\_ 1/s
  - d) Available area for set up length \_\_\_\_\_ mm, width \_\_\_\_\_ mm,  
diameter \_\_\_\_\_ mm, number of load points \_\_\_\_\_
  - e) Maximum mounting height of bearing height \_\_\_\_\_ mm, tolerance, \_\_\_\_\_ +/- mm,
  - f) Permissible deflection \_\_\_\_\_ mm, permissible amplitudes \_\_\_\_\_ mm,
  - g) Is operational reliability/product life of the machine by the elastic bearing? yes            no
- Special requirements:            Quantity/year: \_\_\_\_\_  
Machine type: \_\_\_\_\_

**Sender:**

Company \_\_\_\_\_ Department \_\_\_\_\_  
 Address \_\_\_\_\_ Name/Pos. \_\_\_\_\_  
 \_\_\_\_\_ Telephone \_\_\_\_\_ Fax \_\_\_\_\_  
 Internet \_\_\_\_\_ E-mail \_\_\_\_\_

# ACE

## ACE Product Catalogs

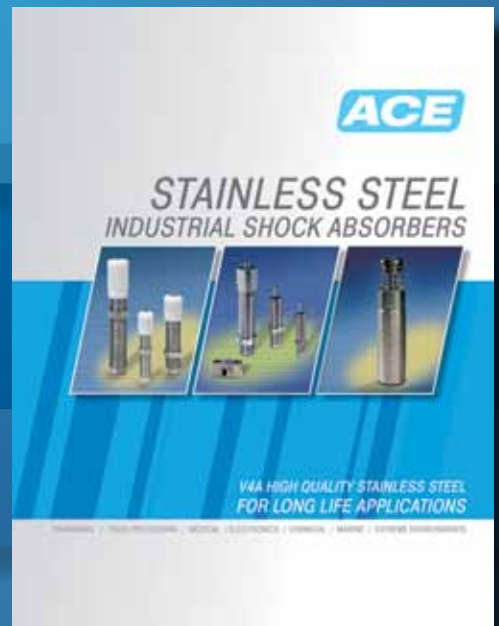
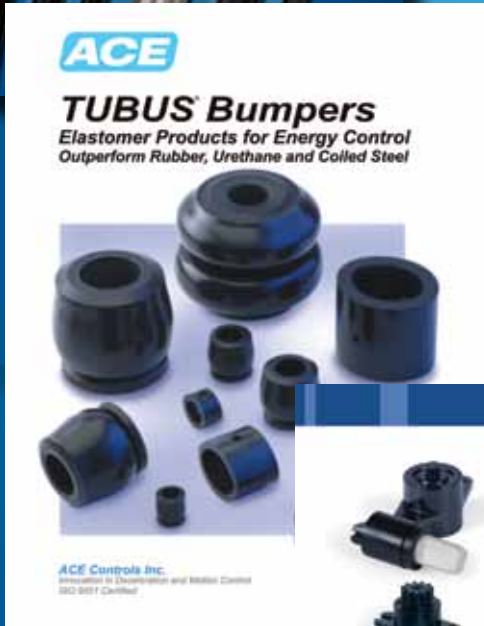
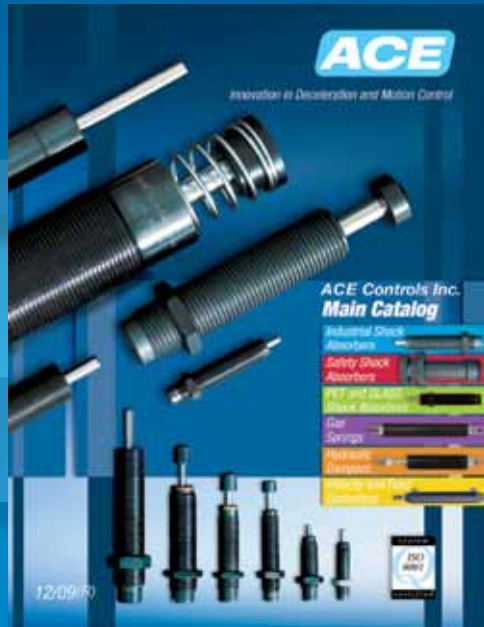

© ACE Controls Inc. 2012  
All Rights Reserved  
Catalog No. 200-0178

ACE Controls Inc. is focused on continuous improvement. Therefore, ACE reserves the right to change models, dimensions or specifications without notice or obligation.





## *Additional Products*

### ***ACE Controls Inc., Innovation in Deceleration & Motion Control***

For nearly 50 years ACE Controls Inc. has provided deceleration and motion control solutions to meet the application needs of industries such as: automotive, packaging, bottling, defense, RV, machine tool, material handling, theme park, medical, fitness and more.

Headquartered in Farmington Hills, Michigan, ACE is structured with a global customer service network that includes offices and distributors in over 100 cities and 35 countries.

To locate a distributor nearest to your location, please visit the ACE Controls web site at [www.acecontrols.com](http://www.acecontrols.com) or contact ACE direct at e-mail: [shocks@acecontrols.com](mailto:shocks@acecontrols.com)

### ***Additional ACE Controls Motion Control Products***



***Industrial & Safety Shock Absorbers***



***Stainless Steel Shock Absorbers***



***Gas Springs  
(Stainless Available)***



***Hydraulic Dampers***



***Velocity Controllers***



***TUBUS Elastomer Bumpers***



***Rotary Dampers***

