

Main Catalog Edition 7/2014

Industrial
Shock Absorbers



New Models

Safety
Shock Absorbers

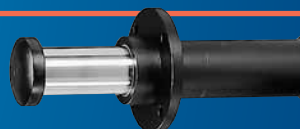

TUBUS
Profile Dampers



New Models

SLAB
Damping Plates

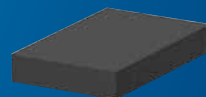

Rotary
Dampers



Dampers/
Feed Controls



Industrial
Gas Springs



LOCKED
Clamping Elements



New Models

Locate and Eliminate Disturbing Vibration

Vibration Isolation



- Free App for iPhone, iPad and iPod Touch
- 3-Axis measurement system
- Simple & comprehensible menu
- Immediate product recommendation
- Available in English, German and French

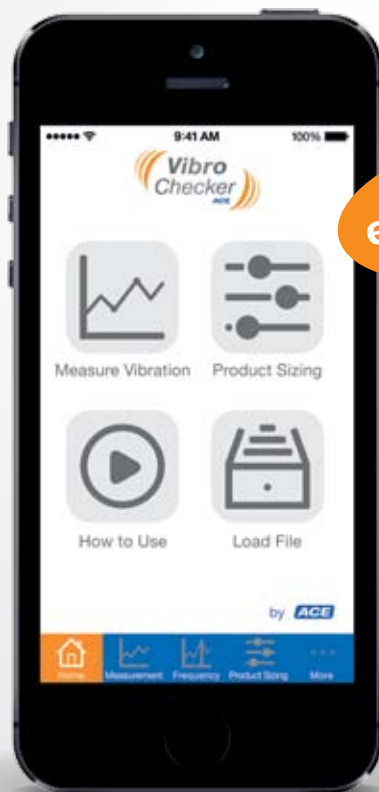

easy & free

Keep it calm.

Measure your possibilities.



Mass with assembly force		Technical data and notes			
 <p>MC4575M-2 Integrated position stop and fully threaded outer body Industrial shock absorber with precompressing thread M50x1.5, Stroke 75 mm.</p>					
Results (normal)					
Mass to be decelerated	m min	220 kg	Intrinsic energy	W _i	307.5 Nm
Velocity	v ₀ max	300 mm/s	Preloading force	W ₂	112.5 Nm
Cycles per hour	n	1.5 1/h	Total energy stroke	W ₁	682.5 Nm
Name of shock absorber model			Capacity		44.8 %
Preloading force	F	1632 N	Total energy / h	W _h	23820 Nm/h
			Capacity		58.4 %
			Effective weight	m _e	180.8 kg
			Total reaction force	Q	8000 N
			Dissipation rate		1 - 83.4 %
			Total deceleration rate	a	23.5 m/s ²
			Stroke velocity	v ₀	1.50 m/s
Environment					
Ambient temperature T 20 °C					

On this page we would like to present our **free additional services**. We provide these services to assist you **from identification of the problem to solution**.

Tell us about your requirements.

Take advantage of our more than 40 years of expert knowledge in damping technology.

Furthermore: ACE service support and products are available in more than 40 countries worldwide.



With our user-friendly calculation program in the internet you can select the right product – online or via download of the program. The CAD data is available in all standard formats in 2D and 3D.

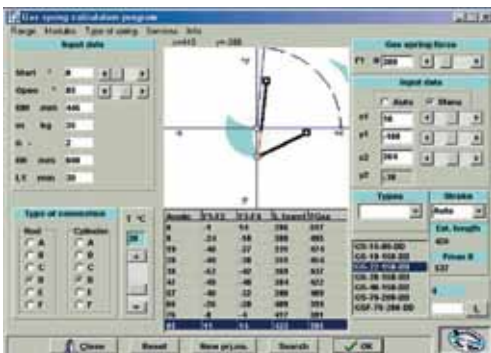
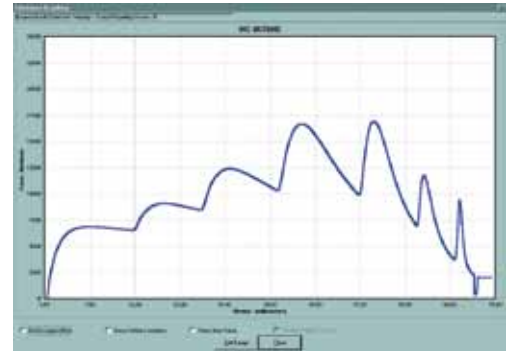

Our specialist engineers create detailed technical solutions for you including assembly suggestions and details on machine loads, brake time and workload etc.



Certified Quality

ACE products are exclusively manufactured from high quality and environmentally compatible materials. With permanent quality monitoring and the performance of test programs, a constant high quality can be guaranteed. ACE pursues continual improvement in all areas in order to arrange material and energy consumption, the production of damaging substances and recycling or disposal of end products as gently on resources as possible. It is important to us to keep the strain on the environment as low as possible and simultaneously improve our services. With ongoing optimisation of end products, we also give our customers the option of designing their products to be smaller, more effective and more energy-saving.



Issue 7.2014. Specifications subject to change

All rights to the production, trade names, design and illustrations of this catalogue are reserved. No part of this publication may be reproduced, copied or printed without permission; violations will be prosecuted. Construction, dimensions and specifications of ACE products are subject to change.

Industrial Shock Absorbers



Industrial shock absorbers are used as hydraulic machine components for slowing down moving loads with minimal reaction force.

ACE shock absorbers are characterized by the use of the most recent and innovative technologies such as the piston tube, stretch or rolling diaphragm technique. Thus, the shock absorbers offer the longest service life in high energy absorption.

ACE industrial shock absorbers are machine components that are easy to use and also flexible in use with their multitude of optional accessories.

Safety Shock Absorbers



Safety shock absorbers are used to provide security in emergency stop applications. Auto warehouse units, conveyors, or crane equipment, they are an inexpensive alternative to industrial shock absorbers. Safety shock absorbers are maintenance-free, self-contained and constructed with an integrated positive stop. They feature an integrated diaphragm accumulator or work with a compressed nitrogen bladder. ACE

offers safety shock absorbers with strokes from 23 to 1200 mm. Following model selection we calculate the layout of the damping orifices for your individual requirements.

TUBUS Profile Dampers



The innovative **TUBUS profile dampers** are a cost-efficient alternative for emergency stop applications and continuous use. They are made from a special co-polyester elastomer. They constantly absorb energies in areas in which other materials fail. The excellent damping characteristics are achieved as a result of the special elastomer material and the world-wide-patented design. The profile dampers are con-

structed to absorb the emerging energy with a damping curve that is declining (TA-series), almost linear (TS-series) or progressive (TR-series). The TUBUS series comprises 7 main types with over 140 individual models.

SLAB Damping Plates



ACE-SLAB damping plates work using visco-elastic damping of impacts and oscillation and offer constructors new perspectives for the large-scale energy absorption or customer-specific forms. Thanks to the simple installation using adhesives, they are an ideal solution for many damping requirements, for noise reduction and for the absorption or insulation of vibrations. The high-tech material made of microcellular

polyurethane elastomers is foamed using water in an environmentally safe manner. SLAB damping plates can easily be bonded to other materials, self-adhesive backing films or wearing surfaces, thus enlarging considerably the wide range of application.

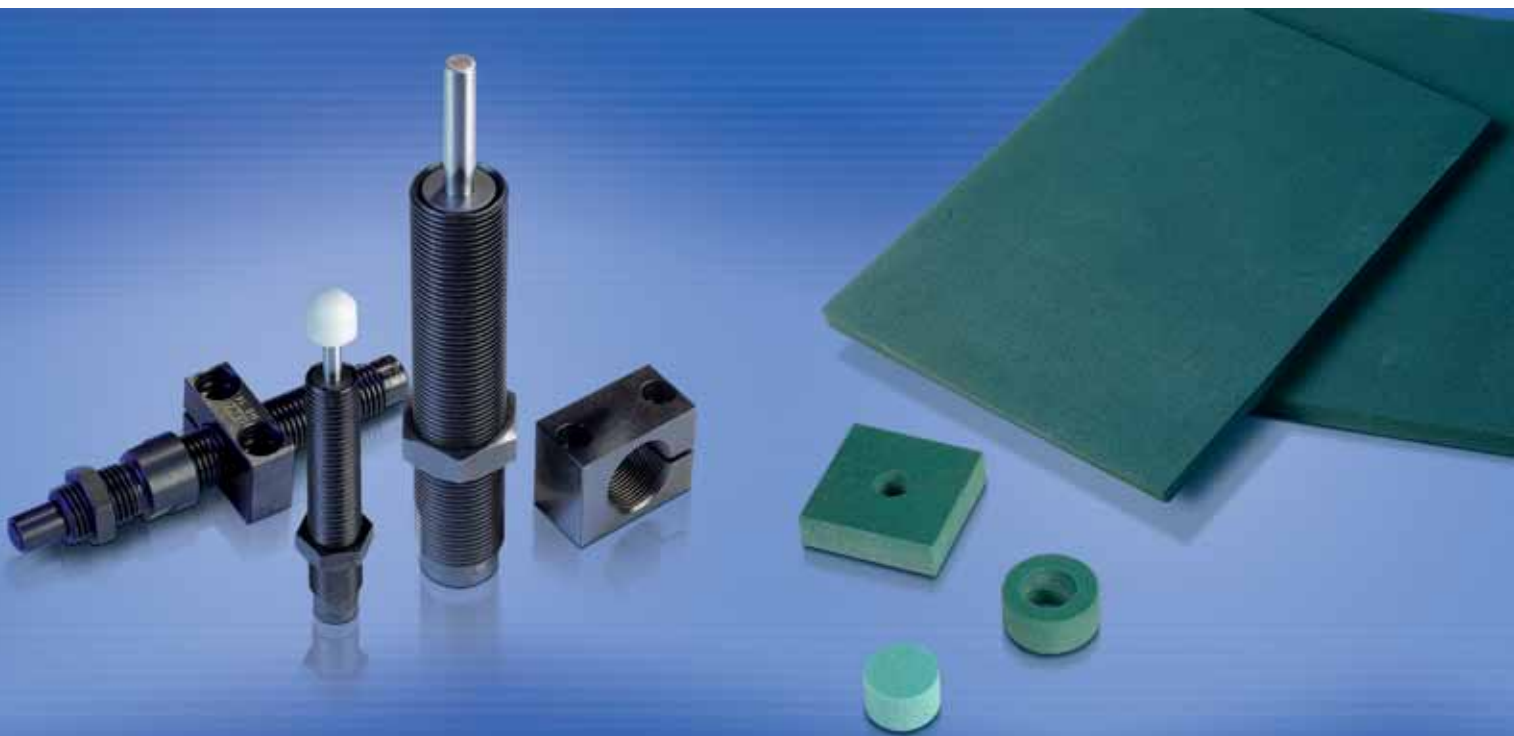



Your advantages:

- Safe and reliable production
- High service life of the machine
- Lightweight and low cost construction
- Low operating costs
- Quiet and economic machines
- Low machine load
- Increased profits

Design, function, calculation and capacity chart	10 - 17
MC5 to 600 and PMC150 to 600	18 - 25
SC190 to 925 and SC ² -Series	26 - 29
MA30 to 900	30 - 31
Accessories M5 to M25	32 - 39
MAGNUM-Series	40 - 53
Air/Oil tanks	55
CA2 to 4 and A1 ½ to 3	56 - 61
Installation and application examples	62 - 65

NEW

Your advantages:

- Optimal machine protection
- Lightweight and low cost construction
- Maximum traverse paths
- State-of-the-art damping technology
- Almost universally applicable

SCS33 to 64	66 - 69
SCS38 to 63	70 - 73
CB63 to 160	74 - 77
EB63 to 160	78 - 81
General instructions	82
Application Examples	83

Your advantages:

- Inexpensive
- Small and light construction
- Space-saving design
- Production safety
- Usable with temperatures from -40 °C to 90 °C
- Resistant to grease, oils, petrol, microbes, chemicals, sea-water

TA12 to 116	84 - 85
TS14 to 107	86 - 87
TR29 to 100	88 - 89
TR-H30 to 102	90 - 91
TR-L29 to 188	92 - 93
TR-HD42 to 117	94 - 95
TC64 to 176	96 - 97
TUBUS special products and applications	98 - 99
Profile dampers – overview and application examples	100 - 101

NEW

NEW

Your advantages:

- Produced according to a patented formula
- Produced without use of propellant gas
- Homogeneous structure and reproducible damping rates
- Customer specific dimensions

SLAB SL-030 to SL-300	102 - 108
SLAB Vibration damping plates	109
Adhesive recommendation and technical information	110
Chemical resistance and sample plates	111
Application examples	112 - 113

NEW





Rotary Dampers



The **rotary damper** is a maintenance-free machine component for controlling rotary or linear motion. ACE rotary dampers ensure a controlled opening and/or closing of small lids, flaps and drawers. The harmonic, soft motion sequence protects sensitive components and increases the quality, value and functionality of the product.

Hydraulic Dampers and Feed Controls



Feed controls are infinitely adjustable and provide accurate feed rate control. They are ideal for sawing, grinding and boring machines.

Hydraulic dampers are used to control traverse rates. They can control the parallel feed in both directions or be used as a compensating element for moving loads. As a security element, they prevent the sudden retraction of devices.

Industrial Gas Springs



Gas springs (push type) can be used with all applications in which the lifting and lowering of loads must be controlled. They support manual forces and are used to control the lifting and lowering of lids, flaps, hoods etc. They are maintenance-free, self-contained and deliverable ex stock. Their integral grease chamber provides a lower breakout force, reduced friction and extremely long life.

Industrial traction gas springs are effective in the pulling direction. Both types are fitted with a valve. This allows matching to the required force for any application.

LOCKED Clamping Elements



The **clamping elements of the LOCKED series** from ACE offer the highest clamping and braking forces in the shortest reaction times through the system of pneumatically pre-loaded spring plates. The clamping elements are suitable for direct clamping and braking on linear guides, rods and shafts. Axial and radial movements can be clamped or slowed with these clamping elements.



Your advantages:

- Maintenance-free and self-contained
- Safe motion
- Design-oriented
- Economical construction
- Broad range of application
- Increased value of your product thanks to high component quality

FRT-E2, FRT-G2	114 - 129
FRT/FRN-C2 and -D2	116
FRT/FRN-K2, FRT/FRN-F2 and FFD	117
FDT and FDN	118
FYN-P1, FYN-N1	119 - 120
FYN-U1, FYN-S1	121
FYT/FYN-H1 and -LA3	122 - 123
Calculations and accessories	124
Application examples	125

Your advantages with feed controls:

- Sensitive adjustment
- Immediately deliverable from stock
- Stick-slip-free

Your advantages with hydraulic dampers:

- Constant speed rates
- Standard version, ex stock
- Easy to mount

VC25, FA, MA and MVC	126 - 129
Application examples	129
DVC	130 - 131
HBD-70	132 - 133
HBS-28 to 70	134 - 137
HB-12 to 70	138 - 144
Adjustment instructions HBS/HB	145
TD-28 and TDE-28	146
Application examples	147

Your advantages:

- Immediately deliverable from stock with valve
- Individual filling by valve technology
- Calculation program for individual design
- Maintenance-free
- Extensive range of fittings available

Function, calculation and mounting tips	148 - 151
Gas springs (push type) GS-8 to 70 and GST-40	152 - 163
Stainless steel gas springs (push type)	164 - 172
Application examples	173
Industrial traction gas springs GZ-15 to 40	174 - 178
Stainless steel traction gas springs	179 - 183
Accessories for gas springs and hydraulic dampers	184 - 191

Your advantages:

- Highest clamping forces
- Shortest reaction times
- Compact design
- Easy to mount

LOCKED-Series PL and SL	192 - 193
LOCKED-Series PLK and SLK	194 - 195
LOCKED-Series LZ-P and PN	196 - 199
LOCKED-Series PRK	200 - 201
LOCKED-Series R	202 - 203
Design, function and general installation hints	204 - 205
Application examples	206
Notes, distributor stock locations	207 - 209
International distributors	210 - 211

NEW

ACE Industrial Shock Absorbers



ACE industrial shock absorbers are high quality dampers for smooth deceleration in end position of automatic processes. High energy absorption capacity and solid construction guarantee a long lifespan; including in harsh environments. The absorbers are available in various sizes to slow down masses weighing just a few grams to more than 100 tonnes.

Features

- Increase in production
- Long lifespan of the machine
- Simple, inexpensive construction
- Quiet, energy saving machines
- Available in Ø 5 mm to 190 mm
- Delivery in 24 hours



ACE Safety Shock Absorbers



ACE safety shock absorbers are designed for emergency-stop situations in industrial and crane applications. They are individually tailored to the relevant application for emergency-stop.

Application examples

- Portal cranes
- Conveyor systems
- Automated storage and retrieval systems
- Harbour cranes and bridges
- Floodgates



ACE-TUBUS Profile Dampers

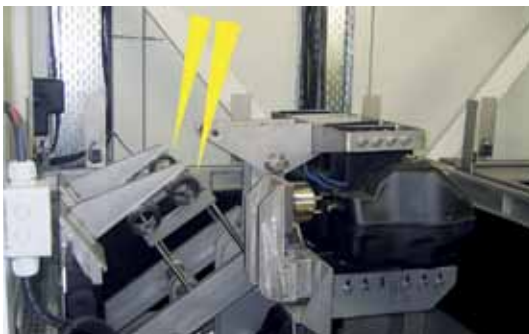

ACE-TUBUS profile dampers are the alternative for applications in which the mass does not have to be stopped in an exact position or the energy does not have to be 100 % removed.

Features

- Low weight
- Small installation size
- Inexpensive safety element
- Simple assembly
- Up to 73 % energy absorption
- For use in clean rooms



With the kind permission of Worthmann Maschinenbau GmbH



ACE-SLAB Damping Plates



ACE-SLAB damping plates work using the visco-elastic damping of impacts and oscillation and offer constructors new perspectives for the large-scale energy absorption or customer-specific forms. Thanks to the simple installation using adhesives, they are an ideal solution for many damping requirements, for noise reduction and for the absorption of vibrations.

Features

- Produced according to a patented formula
- Operating temperature range between -30 °C and 50 °C
- Large area impact absorption
- The effectiveness of the elastic damping can be determined in advance

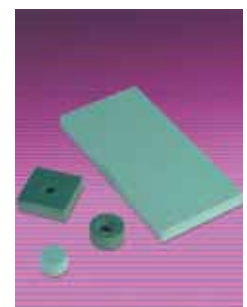

ACE Rotary Dampers



ACE rotary dampers ensure controlled rotational movements; either in one direction or in both directions of rotation. Adjustable or fixed control with torques of 0.0001 Nm to 40 Nm available.

Application examples

- Photocopier lids
- Cassette and CD inserts
- Car glove compartments
- Fold-away supports or tables (bus and airplane industry)
- Furniture industry (drawers and doors)



ACE Hydraulic Dampers and Feed Controls



ACE hydraulic dampers and feed controls help you precisely regulate critical feeds in the wood, plastic, metal and glass industry.

Features

- Constant speed
- Precise control
- Double-sided control
- Strokes up to 800 mm
- Forces up to 50 000 N
- Adjustable
- Delivery in 24 hours



ACE Industrial Gas Springs



ACE gas springs support muscle power and help you with the controlled lifting and lowering of lids, hoods, flaps and machine screens.

Features

- Reduction of the muscle power required
- Large forces in small units
- Controlled input and output speeds
- Controlled movement using just one finger
- Increased safety
- Adjustable
- Delivery in 24 hours



ACE-LOCKED Clamping Elements



The clamping elements of the LOCKED series from ACE offer the highest clamping and braking forces in the shortest reaction times through the system of pneumatically pre-loaded spring plates. The clamping elements are suitable for direct clamping and braking on linear guides, rods and shafts. Axial and radial movements can be clamped or slowed with these clamping elements.

Features

- Highest clamping forces
- Shortest reaction times
- Compact design
- Easy to mount
- Sure positioning



With the kind permission of KOMAGE Gellner Maschinenfabrik KG

Virtually all manufacturing processes involve movement of some kind. In production machinery this can involve linear transfers, rotary index motions, fast feeds etc. At some point these motions change direction or come to a stop.

Any moving object possesses kinetic energy as a result of its motion and if the object changes direction or is brought to rest, the dissipation of this kinetic energy can result in destructive impact forces within the structural and operating parts of the machine.

Kinetic energy increases as the square of the speed and the heavier the object, or the faster it travels, the more energy it has. An increase in production rates is only possible by dissipating this kinetic energy smoothly and thereby eliminating destructive deceleration forces.

Older methods of energy absorption such as rubber buffers, springs, hydraulic dashpots and cylinder cushions do not provide this required smooth deceleration characteristic – they are non linear and produce high peak forces at some point during their stroke.

The optimum solution is achieved by an **ACE industrial shock absorber**. This utilises a series of metering orifices spaced throughout its stroke length and provides a **constant linear deceleration** with the lowest possible reaction force in the shortest stopping time.

ACE Controlled Linear Deceleration!



ACE demo showing a wine glass dropping free fall 1.3 m. Decelerated by an ACE shock absorber not a drop of wine is spilled.

Stopping with Rubber Buffers, Springs, Dashpots or Cylinder Cushions

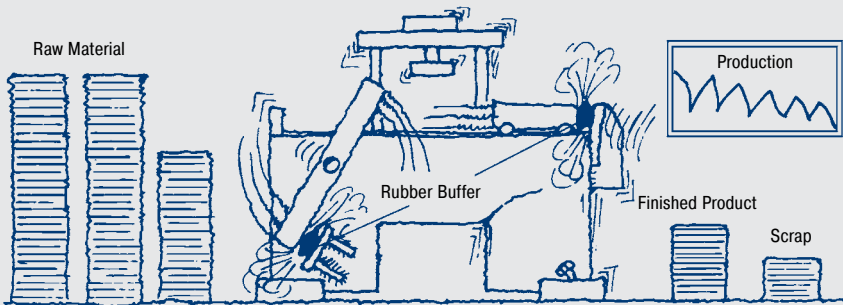

Stopping with ACE Shock Absorbers

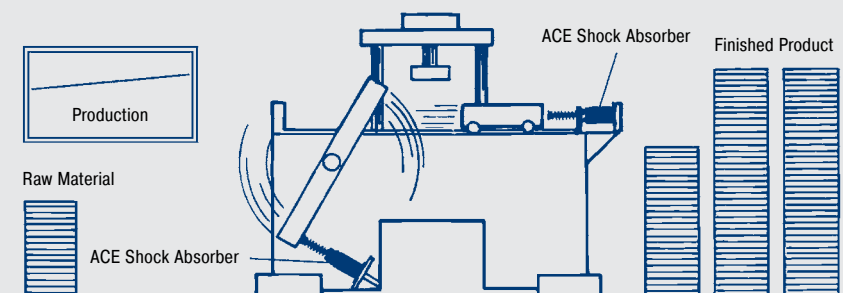

Result

- Loss of production
- Machine damage
- Increased maintenance costs
- Increased operating noise
- Higher machine construction costs

Your Advantages

- Increased production
- Increased operating life of the machine
- Improved machine efficiency
- Reduced construction costs of the machine
- Reduced maintenance costs
- Reduced noise pollution
- Reduced energy costs

Issue 7.2014 Specifications subject to change

Comparison

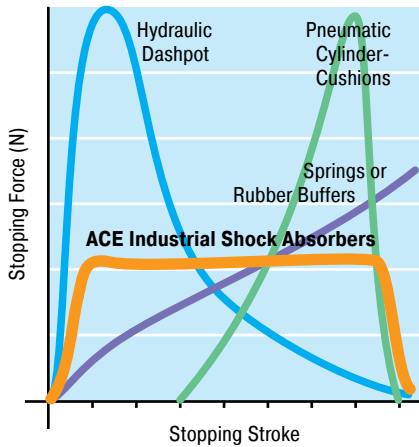

- 1. Hydraulic Dashpot (High stopping force at start of the stroke).**
With only one metering orifice the moving load is abruptly slowed down at the start of the stroke. The braking force rises to a very high peak at the start of the stroke (giving high shock loads) and then falls away rapidly.
- 2. Springs and Rubber Buffers (High stopping forces at end of stroke).**
At full compression. Also they store energy rather than dissipating it, causing the load to rebound back again.
- 3. Air Buffers, Pneumatic Cylinder Cushions (High stopping force at end of stroke).**
Due to the compressibility of air these have a sharply rising force characteristic towards the end of the stroke. The majority of the energy is absorbed near the end of the stroke.
- 4. ACE Industrial Shock Absorbers (Uniform stopping force through the entire stroke).**
The moving load is smoothly and gently brought to rest by a constant resisting force throughout the entire shock absorber stroke. The load is decelerated with the lowest possible force in the shortest possible time eliminating damaging force peaks and shock damage to machines and equipment. This is a linear deceleration force stroke curve and is the curve provided by ACE industrial shock absorbers. In addition they considerably reduce noise pollution.

Energy Capacity

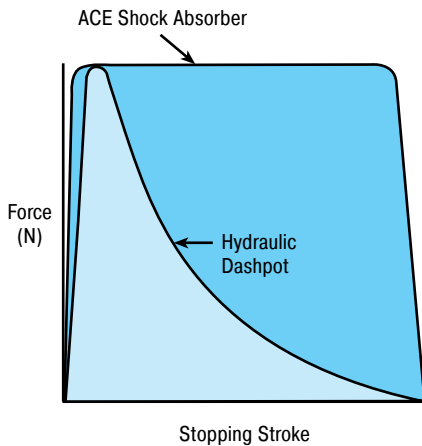

Assumption:
Same maximum reaction force.

Result:
The ACE shock absorber can absorb considerably more energy (represented by the area under the curve).

Your advantage:
By installing an ACE shock absorber production rates can be more than **doubled without increasing deceleration forces** or reaction forces on the machine.

Reaction Force (Stopping Force)

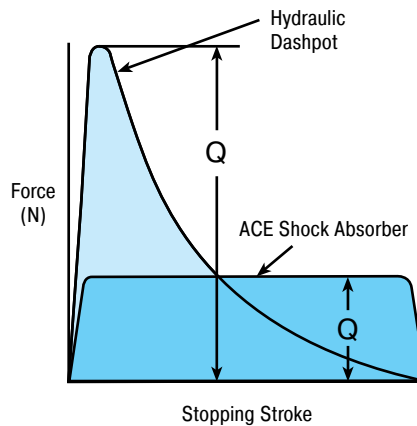

Assumption:
Same energy absorption (area under the curve).

Result:
The reaction force transmitted by the ACE shock absorber is very much lower.

Your advantage:
By installing the ACE shock absorber **the machine wear and maintenance can be drastically reduced.**

Stopping Time

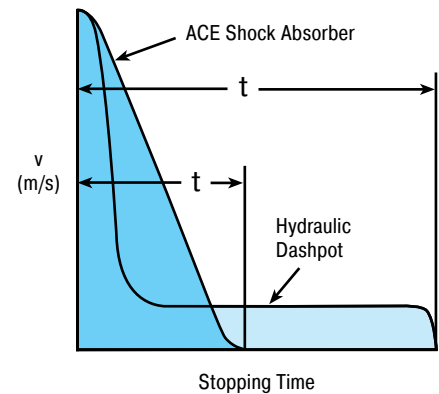

Assumption:
Same energy absorption.

Result:
The ACE shock absorber stops the moving load in a much shorter time.

Your advantage:
By installing an ACE shock absorber cycle times are **reduced giving much higher production rates.**

Comparison of Design

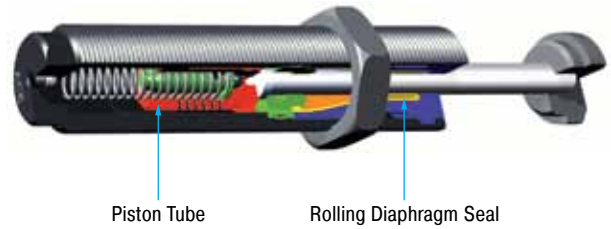
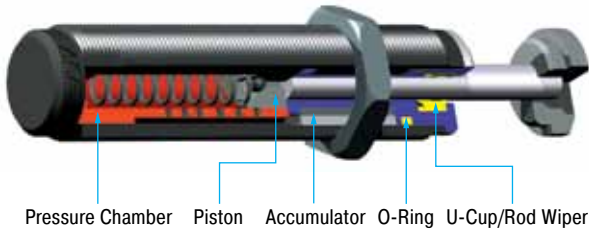

Standard Design of ACE Miniature Shock Absorbers

These miniature shock absorbers have a static pressure chamber. The dynamic piston forces the hydraulic oil to escape through the metering orifices.

The displaced oil is absorbed by the accumulator.

A static seal system containing a U-cup and a wiper seals the shock absorber internally.

The outer body and the pressure chamber are fully machined from solid with closed rear end.

ACE Design for Higher Demands

ACE Piston Tube Technology:

The increased volume of displaced hydraulic oil provides **200% more energy absorption capacity** in comparison with the standard design. The wider effective weight range enables these dampers to cover a much wider range of applications. The piston and inner tube are combined into a single component.

ACE Stretch and Rolling Diaphragm System:

By the proven dynamic ACE rolling diaphragm seal system the shock absorber becomes hermetically sealed and provides **up to 25 million cycles**. The rolling diaphragm seal allows direct installation into the end cover of pneumatic cylinders (up to 7 bar).

These technologies are used separately or combined on the **MC150M to MC600M, SC²25M to SC²650M** and on the model **MA150M**.

General Function

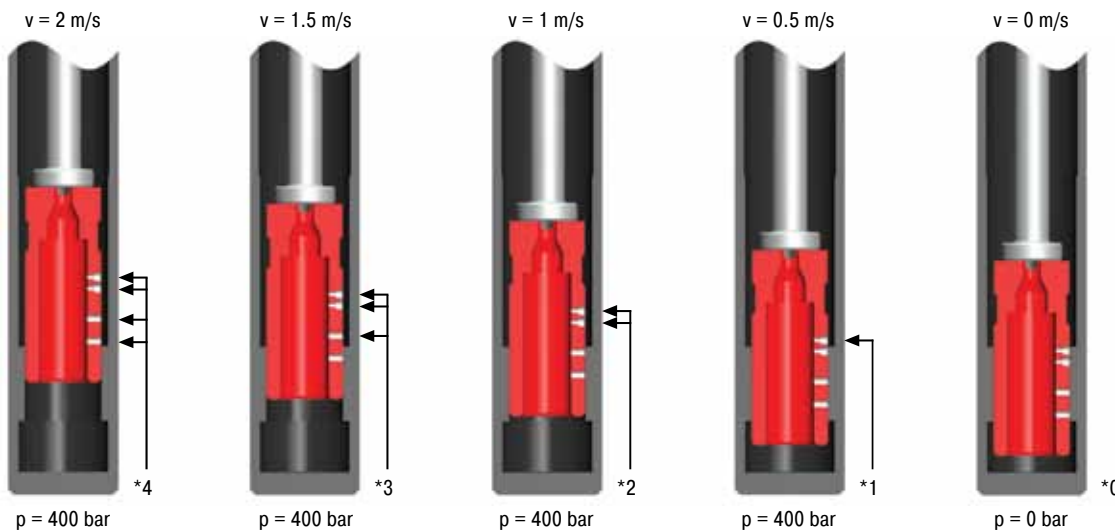

* The load velocity reduces continuously as you travel through the stroke due to the reduction in the number of metering orifices (*) in action. The internal pressure remains essentially constant and thus the force vs. stroke curve remains linear.

F = force (N)
 p = internal pressure (bar)
 s = stroke (m)
 t = deceleration time (s)
 v = velocity (m/s)

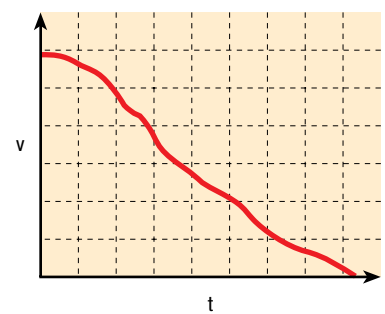
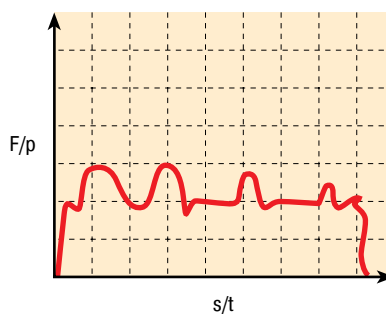

ACE shock absorbers provide linear deceleration and are therefore superior to other kinds of damping element. It is easy to calculate around 90% of applications knowing only the following 5 parameters:

Key to symbols used

W_1	Kinetic energy per cycle	Nm	3 ST	Stall torque factor (normally 2.5)	1 to 3
W_2	Propelling force energy per cycle	Nm	M	Propelling torque	Nm
W_3	Total energy per cycle ($W_1 + W_2$)	Nm	I	Moment of Inertia	kgm ²
$^1 W_4$	Total energy per hour ($W_3 \cdot c$)	Nm/hr	g	Acceleration due to gravity = 9.81	m/s ²
m_e	Effective weight	kg	h	Drop height excl. shock absorber stroke	m
m	Mass to be decelerated	kg	s	Shock absorber stroke	m
n	Number of shock absorbers (in parallel)		L/R/r	Radius	m
$^2 v$	Velocity at impact	m/s	Q	Reaction force	N
$^2 v_D$	Impact velocity at shock absorber	m/s	μ	Coefficient of friction	
ω	Angular velocity at impact	rad/s	t	Deceleration time	s
F	Propelling force	N	a	Deceleration	m/s ²
c	Cycles per hour	1/hr	α	Side load angle	°
P	Motor power	kW	β	Angle of incline	°

1. Mass to be decelerated (weight) m (kg)
2. Impact velocity at shock absorber v_D (m/s)
3. Propelling force F (N)
4. Cycles per hour c (/hr)
5. Number of absorbers in parallel n

¹ All mentioned values of W_4 in the capacity charts are only valid for room temperature. There are reduced values at higher temperature ranges.

² v or v_D is the final impact velocity of the mass. With accelerating motion the final impact velocity can be 1.5 to 2 times higher than the average. Please take this into account when calculating kinetic energy.

$^3 ST$	Stall torque factor (normally 2.5)	1 to 3
M	Propelling torque	Nm
I	Moment of Inertia	kgm ²
g	Acceleration due to gravity = 9.81	m/s ²
h	Drop height excl. shock absorber stroke	m
s	Shock absorber stroke	m
L/R/r	Radius	m
Q	Reaction force	N
μ	Coefficient of friction	
t	Deceleration time	s
a	Deceleration	m/s ²
α	Side load angle	°
β	Angle of incline	°

³ ST Δ relation between starting torque and running torque of the motor (depending on the design)

In all the following examples the choice of shock absorbers made from the capacity chart is based upon the values of (W_3), (W_4), (m_e) and the desired shock absorber stroke (s).

1 Mass without propelling force

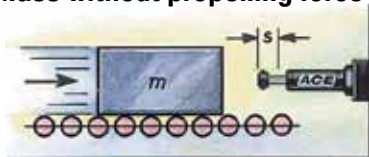

Formulae

$$W_1 = m \cdot v^2 \cdot 0.5$$

$$W_2 = 0$$

$$W_3 = W_1 + W_2$$

$$W_4 = W_3 \cdot c$$

$$v_D = v$$

$$m_e = m$$

Example

$$m = 100 \text{ kg}$$

$$v = 1.5 \text{ m/s}$$

$$c = 500 \text{ /hr}$$

$$s = 0.050 \text{ m (chosen)}$$

$$W_1 = 100 \cdot 1.5^2 \cdot 0.5 = 113 \text{ Nm}$$

$$W_2 = 0$$

$$W_3 = 113 + 0 = 113 \text{ Nm}$$

$$W_4 = 113 \cdot 500 = 56500 \text{ Nm/hr}$$

$$m_e = m = 100 \text{ kg}$$

Chosen from capacity chart:
Model MC3350M-2 self-compensating

2 Mass with propelling force

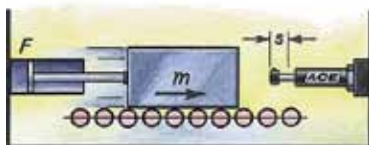

Formulae

$$W_1 = m \cdot v^2 \cdot 0.5$$

$$W_2 = F \cdot s$$

$$W_3 = W_1 + W_2$$

$$W_4 = W_3 \cdot c$$

$$v_D = v$$

$$m_e = \frac{2 \cdot W_3}{v_D^2}$$

$$W_2 = (F - m \cdot g) \cdot s$$

$$W_2 = (F + m \cdot g) \cdot s$$

Example

$$m = 36 \text{ kg}$$

$$^1 v = 1.5 \text{ m/s}$$

$$F = 400 \text{ N}$$

$$c = 1000 \text{ /hr}$$

$$s = 0.025 \text{ m (chosen)}$$

$$W_1 = 36 \cdot 1.5^2 \cdot 0.5 = 41 \text{ Nm}$$

$$W_2 = 400 \cdot 0.025 = 10 \text{ Nm}$$

$$W_3 = 41 + 10 = 51 \text{ Nm}$$

$$W_4 = 51 \cdot 1000 = 51000 \text{ Nm/hr}$$

$$m_e = 2 \cdot 51 : 1.5^2 = 45 \text{ kg}$$

Chosen from capacity chart:
Model MC600M self-compensating

¹ v is the final impact velocity of the mass: With pneumatically propelled systems this can be 1.5 to 2 times the average velocity. Please take this into account when calculating energy.

- 2.1 for vertical motion upwards \longrightarrow
- 2.2 for vertical motion downwards \longrightarrow

3 Mass with motor drive

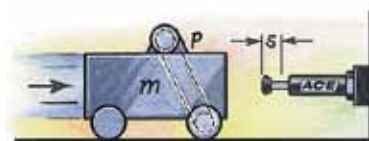

Formulae

$$W_1 = m \cdot v^2 \cdot 0.5$$

$$W_2 = \frac{1000 \cdot P \cdot ST \cdot s}{v}$$

$$W_3 = W_1 + W_2$$

$$W_4 = W_3 \cdot c$$

$$v_D = v$$

$$m_e = \frac{2 \cdot W_3}{v_D^2}$$

Example

$$m = 800 \text{ kg}$$

$$v = 1.2 \text{ m/s}$$

$$ST = 2.5$$

$$P = 4 \text{ kW}$$

$$c = 100 \text{ /hr}$$

$$s = 0.100 \text{ m (chosen)}$$

$$W_1 = 800 \cdot 1.2^2 \cdot 0.5 = 576 \text{ Nm}$$

$$W_2 = 1000 \cdot 4 \cdot 2.5 \cdot 0.1 : 1.2 = 834 \text{ Nm}$$

$$W_3 = 576 + 834 = 1410 \text{ Nm}$$

$$W_4 = 1410 \cdot 100 = 141000 \text{ Nm/hr}$$

$$m_e = 2 \cdot 1410 : 1.2^2 = 1958 \text{ kg}$$

Chosen from capacity chart:
Model MC64100M-2 self-compensating

Note: Do not forget to include the rotational energy of motor, coupling and gearbox into calculation for W_1 .

4 Mass on driven rollers

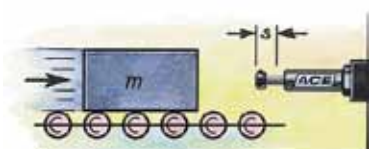

Formulae

$$W_1 = m \cdot v^2 \cdot 0.5$$

$$W_2 = m \cdot \mu \cdot g \cdot s$$

$$W_3 = W_1 + W_2$$

$$W_4 = W_3 \cdot c$$

$$v_D = v$$

$$m_e = \frac{2 \cdot W_3}{v_D^2}$$

Example

$$m = 250 \text{ kg}$$

$$v = 1.5 \text{ m/s}$$

$$c = 180 \text{ /hr}$$

$$s = 0.050 \text{ m (chosen)}$$

(Steel/Steel) $\mu = 0.2$

$$W_1 = 250 \cdot 1.5^2 \cdot 0.5 = 281 \text{ Nm}$$

$$W_2 = 250 \cdot 0.2 \cdot 9.81 \cdot 0.05 = 25 \text{ Nm}$$

$$W_3 = 281 + 25 = 306 \text{ Nm}$$

$$W_4 = 306 \cdot 180 = 55080 \text{ Nm/hr}$$

$$m_e = 2 \cdot 306 : 1.5^2 = 272 \text{ kg}$$

Chosen from capacity chart:
Model MC4550M-2 self-compensating

5 Swinging mass with propelling force

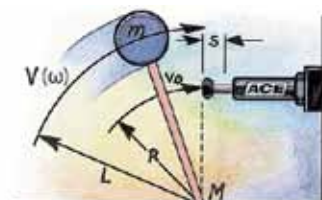

Formulae

$$W_1 = m \cdot v^2 \cdot 0.5 = 0.5 \cdot l \cdot \omega^2$$

$$W_2 = \frac{M \cdot s}{R}$$

$$W_3 = W_1 + W_2$$

$$W_4 = W_3 \cdot c$$

$$v_D = \frac{v \cdot R}{L} = \omega \cdot R$$

$$m_e = \frac{2 \cdot W_3}{v_D^2}$$

Example

$$m = 20 \text{ kg}$$

$$v = 1 \text{ m/s}$$

$$M = 50 \text{ Nm}$$

$$R = 0.5 \text{ m}$$

$$L = 0.8 \text{ m}$$

$$c = 1500 \text{ /hr}$$

$$s = 0.012 \text{ m (chosen)}$$

$$W_1 = 20 \cdot 1^2 \cdot 0.5 = 10 \text{ Nm}$$

$$W_2 = 50 \cdot 0.012 : 0.5 = 1.2 \text{ Nm}$$

$$W_3 = 10 + 1.2 = 11.2 \text{ Nm}$$

$$W_4 = 306 \cdot 180 = 16800 \text{ Nm/hr}$$

$$v_D = 1 \cdot 0.5 : 0.8 = 0.63 \text{ m/s}$$

$$m_e = 2 \cdot 11.2 : 0.63^2 = 56 \text{ kg}$$

Chosen from capacity chart:
Model MC150MH self-compensating

Check the side load angle, $\tan \alpha = s/R$, with regard to "Max. Side Load Angle" in the capacity chart (see example 6.2)

6 Free falling mass

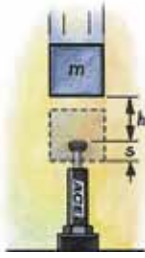

Formulae

$$W_1 = m \cdot g \cdot h$$

$$W_2 = m \cdot g \cdot s$$

$$W_3 = W_1 + W_2$$

$$W_4 = W_3 \cdot c$$

$$v_D = \sqrt{2 \cdot g \cdot h}$$

$$me = \frac{2 \cdot W_3}{v_D^2}$$

Example

$$m = 30 \text{ kg}$$

$$h = 0.5 \text{ m}$$

$$c = 400 \text{ /hr}$$

$$s = 0.050 \text{ m (chosen)}$$

$$W_1 = 30 \cdot 0.5 \cdot 9.81 = 147 \text{ Nm}$$

$$W_2 = 30 \cdot 9.81 \cdot 0.05 = 15 \text{ Nm}$$

$$W_3 = 147 + 15 = 162 \text{ Nm}$$

$$W_4 = 162 \cdot 400 = 64800 \text{ Nm/hr}$$

$$v_D = \sqrt{2 \cdot 9.81 \cdot 0.5} = 3.13 \text{ m/s}$$

$$me = \frac{2 \cdot 162}{3.13^2} = 33 \text{ kg}$$

Chosen from capacity chart:
Model MC3350M-1 self-compensating

6.1 Mass rolling/sliding down incline

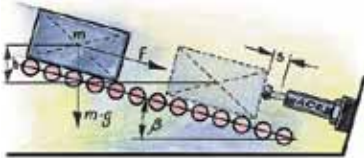

Formulae

$$W_1 = m \cdot g \cdot h = m \cdot v_D^2 \cdot 0.5$$

$$W_2 = m \cdot g \cdot \sin\beta \cdot s$$

$$W_3 = W_1 + W_2$$

$$W_4 = W_3 \cdot c$$

$$v_D = \sqrt{2 \cdot g \cdot h}$$

$$me = \frac{2 \cdot W_3}{v_D^2}$$

6.1 a propelling force up incline
6.1 b propelling force down incline

$$W_2 = (F - m \cdot g \cdot \sin\beta) \cdot s$$

$$W_2 = (F + m \cdot g \cdot \sin\beta) \cdot s$$

6.2 Mass free falling about a pivot point

Side load angle from shock absorber axis

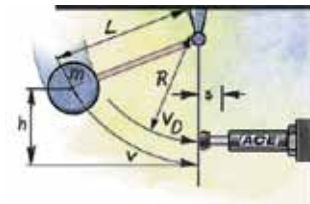

Calculation as per example 6.1 except $W_2 = 0$

$$W_1 = m \cdot g \cdot h$$

$$v_D = \sqrt{2 \cdot g \cdot h} \cdot \frac{R}{L}$$

Check the side load angle, $\tan \alpha = s/R$, with regard to "Max. Side Load Angle" in the capacity chart

7 Rotary index table with propelling torque

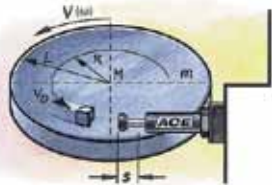

Formulae

$$W_1 = m \cdot v^2 \cdot 0.25 = 0.5 \cdot l \cdot \omega^2$$

$$W_2 = \frac{M \cdot s}{R}$$

$$W_3 = W_1 + W_2$$

$$W_4 = W_3 \cdot c$$

$$v_D = \frac{v \cdot R}{L} = \omega \cdot R$$

$$me = \frac{2 \cdot W_3}{v_D^2}$$

Example

$$m = 1000 \text{ kg}$$

$$v = 1.1 \text{ m/s}$$

$$M = 1000 \text{ Nm}$$

$$s = 0.050 \text{ m (chosen)}$$

$$L = 1.25 \text{ m}$$

$$R = 0.8 \text{ m}$$

$$c = 100 \text{ /hr}$$

$$W_1 = 1000 \cdot 1.1^2 \cdot 0.25 = 303 \text{ Nm}$$

$$W_2 = 300 \cdot 0.025 : 0.8 = 63 \text{ Nm}$$

$$W_3 = 28 + 9 = 366 \text{ Nm}$$

$$W_4 = 37 \cdot 1200 = 36600 \text{ Nm/hr}$$

$$v_D = 1.1 \cdot 0.8 : 1.25 = 0.7 \text{ m/s}$$

$$me = 2 \cdot 366 : 0.7^2 = 1494 \text{ kg}$$

Chosen from capacity chart:
Model MC4550M-3 self-compensating
Check the side load angle, $\tan \alpha = s/R$, with regard to "Max. Side Load Angle" in the capacity chart (see example 6.2)

8 Swinging arm with propelling torque (uniform weight distribution)

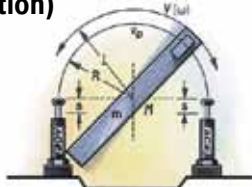

Formulae

$$W_1 = m \cdot v^2 \cdot 0.17 = 0.5 \cdot l \cdot \omega^2$$

$$W_2 = \frac{M \cdot s}{R}$$

$$W_3 = W_1 + W_2$$

$$W_4 = W_3 \cdot c$$

$$v_D = \frac{v \cdot R}{L} = \omega \cdot R$$

$$me = \frac{2 \cdot W_3}{v_D^2}$$

Example

$$l = 56 \text{ kgm}^2$$

$$\omega = 1 \text{ rad/s}$$

$$M = 300 \text{ Nm}$$

$$s = 0.025 \text{ m (chosen)}$$

$$L = 1.5 \text{ m}$$

$$R = 0.8 \text{ m}$$

$$c = 1200 \text{ /hr}$$

$$W_1 = 0.5 \cdot 56 \cdot 1^2 = 28 \text{ Nm}$$

$$W_2 = 300 \cdot 0.025 : 0.8 = 9 \text{ Nm}$$

$$W_3 = 28 + 9 = 37 \text{ Nm}$$

$$W_4 = 37 \cdot 1200 = 44400 \text{ Nm/hr}$$

$$v_D = 1 \cdot 0.8 = 0.8 \text{ m/s}$$

$$me = 2 \cdot 37 : 0.8^2 = 116 \text{ kg}$$

Chosen from capacity chart:
Model MC600M self-compensating
Check the side load angle, $\tan \alpha = s/R$, with regard to "Max. Side Load Angle" in the capacity chart (see example 6.2)

9 Swinging arm with propelling force (uniform weight distribution)

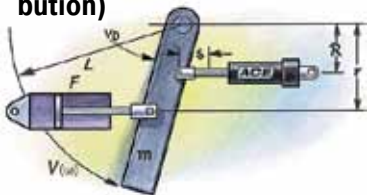

Formulae

$$W_1 = m \cdot v^2 \cdot 0.17 = 0.5 \cdot l \cdot \omega^2$$

$$W_2 = \frac{F \cdot r \cdot s}{R} = \frac{M \cdot s}{R}$$

$$W_3 = W_1 + W_2$$

$$W_4 = W_3 \cdot c$$

$$v_D = \frac{v \cdot R}{L} = \omega \cdot R$$

$$me = \frac{2 \cdot W_3}{v_D^2}$$

Example

$$m = 1000 \text{ kg}$$

$$v = 2 \text{ m/s}$$

$$F = 7000 \text{ N}$$

$$M = 4200 \text{ Nm}$$

$$s = 0.050 \text{ m (chosen)}$$

$$r = 0.6 \text{ m}$$

$$R = 0.8 \text{ m}$$

$$L = 1.2 \text{ m}$$

$$c = 900 \text{ /hr}$$

$$W_1 = 1000 \cdot 2^2 \cdot 0.17 = 680 \text{ Nm}$$

$$W_2 = 7000 \cdot 0.6 \cdot 0.05 : 0.8 = 263 \text{ Nm}$$

$$W_3 = 680 + 263 = 943 \text{ Nm}$$

$$W_4 = 943 \cdot 900 = 848700 \text{ Nm/hr}$$

$$v_D = 2 \cdot 0.8 : 1.2 = 1.33 \text{ m/s}$$

$$me = 2 \cdot 943 : 1.33^2 = 1066 \text{ kg}$$

Chosen from capacity chart:
Model CA2x2-1 self-compensating

10 Mass lowered at controlled speed



Formulae

$$W_1 = m \cdot v^2 \cdot 0.5$$

$$W_2 = m \cdot g \cdot s$$

$$W_3 = W_1 + W_2$$

$$W_4 = W_3 \cdot c$$

$$v_D = v$$

$$me = \frac{2 \cdot W_3}{v_D^2}$$

Example

$$m = 6000 \text{ kg}$$

$$v = 1.5 \text{ m/s}$$

$$s = 0.305 \text{ m (chosen)}$$

$$c = 60 \text{ /hr}$$

$$W_1 = 6000 \cdot 1.5^2 \cdot 0.5 = 6750 \text{ Nm}$$

$$W_2 = 6000 \cdot 9.81 \cdot 0.305 = 17952 \text{ Nm}$$

$$W_3 = 6750 + 17952 = 24702 \text{ Nm}$$

$$W_4 = 24702 \cdot 60 = 1482120 \text{ Nm/hr}$$

$$me = 2 \cdot 24702 : 1.5^2 = 21957 \text{ kg}$$

Chosen from capacity chart:
Model CA3x12-2 self-compensating

Reaction force Q [N]

$$Q = \frac{1.5 \cdot W_3}{s}$$

Stopping time t [s]

$$t = \frac{2.6 \cdot s}{v_D}$$

Deceleration rate a [m/s²]

$$a = \frac{0.75 \cdot v_D^2}{s}$$

Approximate values assuming correct adjustment. Add safety margin if necessary.
(Exact values will depend upon actual application data and can be provided on request.)

19 Wagon against 2 shock absorbers

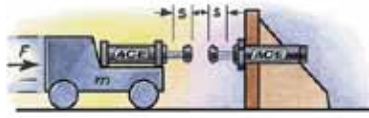

Formulae

$$W_1 = m \cdot v^2 \cdot 0.25$$

$$W_2 = F \cdot s$$

$$W_3 = W_1 + W_2$$

$$W_4 = W_3 \cdot c$$

$$v_D = v \cdot 0.5$$

$$me = \frac{2 \cdot W_3}{v_D^2}$$

Example

$$m = 5000 \text{ kg}$$

$$v = 2 \text{ m/s}$$

$$c = 10 \text{ /hr}$$

$$F = 3500 \text{ N}$$

$$s = 0.150 \text{ m (chosen)}$$

$$W_1 = 5000 \cdot 2^2 \cdot 0.25 = 5000 \text{ Nm}$$

$$W_2 = 3500 \cdot 0.150 = 525 \text{ Nm}$$

$$W_3 = 5000 + 525 = 5525 \text{ Nm}$$

$$W_4 = 5525 \cdot 10 = 55250 \text{ Nm/hr}$$

$$v_D = 2 \cdot 0.5 = 1 \text{ m/s}$$

$$me = 2 \cdot 5525 : 1^2 = 11050 \text{ kg}$$

Chosen from capacity chart:
Model CA2x6-2 self-compensating

20 Wagon against wagon



Formulae

$$W_1 = \frac{m_1 \cdot m_2}{(m_1 + m_2)} \cdot (v_1 + v_2)^2 \cdot 0.5$$

$$W_2 = F \cdot s$$

$$W_3 = W_1 + W_2$$

$$W_4 = W_3 \cdot c$$

$$v_D = v_1 + v_2$$

$$me = \frac{2 \cdot W_3}{v_D^2}$$

Example

$$m = 7000 \text{ kg}$$

$$v_1 = 1.2 \text{ m/s}$$

$$c = 20 \text{ /hr}$$

$$m_2 = 10000 \text{ kg}$$

$$v_2 = 0.5 \text{ m/s}$$

$$F = 5000 \text{ N}$$

$$s = 0.127 \text{ m (chosen)}$$

$$W_1 = \frac{7000 \cdot 10000}{(7000 + 10000)} \cdot 1.7^2 \cdot 0.5 = 5950 \text{ Nm}$$

$$W_2 = 5000 \cdot 0.127 = 635 \text{ Nm}$$

$$W_3 = 5950 + 635 = 6585 \text{ Nm}$$

$$W_4 = 6585 \cdot 20 = 131700 \text{ Nm/hr}$$

$$v_D = 1.2 + 0.5 = 1.7 \text{ m/s}$$

$$me = 2 \cdot 6585 : 1.7^2 = 4557 \text{ kg}$$

Chosen from capacity chart:
Model CA3x5-1 self-compensating

21 Wagon against wagon 2 shock absorbers

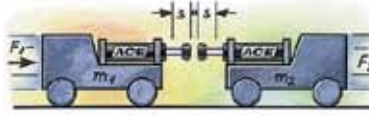

Formulae

$$W_1 = \frac{m_1 \cdot m_2}{(m_1 + m_2)} \cdot (v_1 + v_2)^2 \cdot 0.25$$

$$W_2 = F \cdot s$$

$$W_3 = W_1 + W_2$$

$$W_4 = W_3 \cdot c$$

$$v_D = \frac{v_1 + v_2}{2}$$

$$me = \frac{2 \cdot W_3}{v_D^2}$$

Example

$$m = 7000 \text{ kg}$$

$$v_1 = 1.2 \text{ m/s}$$

$$c = 20 \text{ /hr}$$

$$m_2 = 10000 \text{ kg}$$

$$v_2 = 0.5 \text{ m/s}$$

$$F = 5000 \text{ N}$$

$$s = 0.102 \text{ m (chosen)}$$

$$W_1 = \frac{7000 \cdot 10000}{(7000 + 10000)} \cdot 1.7^2 \cdot 0.25 = 2975 \text{ Nm}$$

$$W_2 = 5000 \cdot 0.102 = 510 \text{ Nm}$$

$$W_3 = 2975 + 510 = 3485 \text{ Nm}$$

$$W_4 = 3485 \cdot 20 = 69700 \text{ Nm/hr}$$

$$v_D = (1.2 + 0.5) : 2 = 0.85 \text{ m/s}$$

$$me = 2 \cdot 3485 : 0.85^2 = 9647 \text{ kg}$$

Chosen from capacity chart:
Model CA2x4-2 self-compensating

Note: When using several shock absorbers in parallel, the values (W₃), (W₄) and (me) are divided according to the number of units used.

Effective Weight (me)

A Mass without propelling force

Formula
 $me = m$

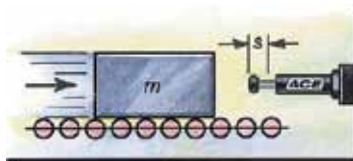

Example

$$m = 100 \text{ kg}$$

$$v_D = v = 2 \text{ m/s}$$

$$W_1 = W_3 = 200 \text{ Nm}$$

$$me = \frac{2 \cdot 200}{4} = 100 \text{ kg}$$

B Mass with propelling force

Formula
 $me = \frac{2 \cdot W_3}{v_D^2}$

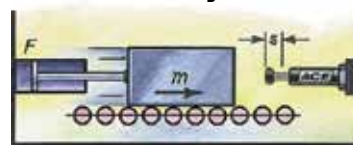

Example

$$m = 100 \text{ kg}$$

$$F = 2000 \text{ N}$$

$$v_D = v = 2 \text{ m/s}$$

$$s = 0.1 \text{ m}$$

$$W_1 = 200 \text{ Nm}$$

$$W_2 = 200 \text{ Nm}$$

$$W_3 = 400 \text{ Nm}$$

$$me = \frac{2 \cdot 400}{4} = 200 \text{ kg}$$

C Mass without propelling force direct against shock absorber

Formula
 $me = m$



Example

$$m = 20 \text{ kg}$$

$$v_D = v = 2 \text{ m/s}$$

$$s = 0.1 \text{ m}$$

$$W_1 = W_3 = 40 \text{ Nm}$$

$$me = \frac{2 \cdot 40}{2^2} = 20 \text{ kg}$$

D Mass without propelling force with mechanical advantage

Formula
 $me = \frac{2 \cdot W_3}{v_D^2}$

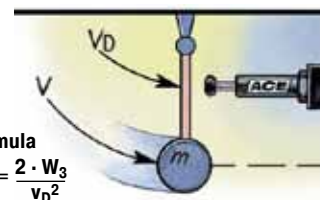

Example

$$m = 20 \text{ kg}$$

$$v = 2 \text{ m/s}$$

$$v_D = 0.5 \text{ m/s}$$

$$s = 0.1 \text{ m}$$

$$W_1 = W_3 = 40 \text{ Nm}$$

$$me = \frac{2 \cdot 40}{0.5^2} = 320 \text{ kg}$$

The effective weight (me) can either be the same as the actual weight (examples A and C), or it can be an imaginary weight representing a combination of the propelling force or lever action plus the actual weight (examples B and D).

Capacity Chart

Type Part Number	Stroke mm	Energy Capacity W ₃ Nm/Cycle	Effective Weight Self-Compensating		Page
			me min. kg	me max. kg	
MC5M-1-B	4	0.68	0.5	4.4	19
MC5M-2-B	4	0.68	3.8	10.8	19
MC5M-3-B	4	0.68	9.7	18.7	19
MC9M-1-B	5	1	0.6	3.2	19
MC9M-2-B	5	1	0.8	4.1	19
MC10ML-B	5	1.25	0.3	2.7	19
MC10MH-B	5	1.25	0.7	5	19
MC30M-1	8	3.5	0.4	1.9	19
MC30M-2	8	3.5	1.8	5.4	19
MC30M-3	8	3.5	5	15	19
MC25M	6	2.8	1.8	5.4	19
MC25MH	6	2.8	4.6	13.6	19
MC25ML	6	2.8	0.7	2.2	19
MC75M-1	10	9	0.3	1.1	19
MC75M-2	10	9	0.9	4.8	19
MC75M-3	10	9	2.7	36.2	19
MC75M-4	10	9	25	72	19
MC150M	12	20	0.9	10	21
MC150MH	12	20	8.6	86	21
MC150MH2	12	20	70	200	21
MC150MH3	12	20	181	408	21
MC225M	12	41	2.3	25	21
MC225MH	12	41	23	230	21
MC225MH2	12	41	180	910	21
MC225MH3	12	41	816	1 814	21
MC600M	25	136	9	136	21
MC600MH	25	136	113	1 130	21
MC600MH2	25	136	400	2 300	21
MC600MH3	25	136	2 177	4 536	21
SC25M-5	8	10	1	5	29
SC25M-6	8	10	4	44	29
SC25M-7	8	10	42	500	29
SC75M-5	10	16	1	8	29
SC75M-6	10	16	7	78	29
SC75M-7	10	16	75	800	29
SC190M-0	16	25	0.7	4	27
SC190M-1	16	25	1.4	7	27
SC190M-2	16	25	3.6	18	27
SC190M-3	16	25	9	45	27
SC190M-4	16	25	23	102	27
SC190M-5	12	31	2	16	29
SC190M-6	12	31	13	140	29
SC190M-7	12	31	136	1 550	29
SC300M-0	19	33	0.7	4	27
SC300M-1	19	33	1.4	8	27
SC300M-2	19	33	4.5	27	27
SC300M-3	19	33	14	82	27
SC300M-4	19	33	32	204	27
SC300M-5	15	73	11	45	29
SC300M-6	15	73	34	136	29
SC300M-7	15	73	91	181	29
SC300M-8	15	73	135	680	29
SC300M-9	15	73	320	1 950	29
SC650M-0	25	73	2.3	14	27
SC650M-1	25	73	8	45	27
SC650M-2	25	73	23	136	27
SC650M-3	25	73	68	408	27
SC650M-4	25	73	204	1 180	27
SC650M-5	23	210	23	113	29
SC650M-6	23	210	90	360	29
SC650M-7	23	210	320	1 090	29
SC650M-8	23	210	770	2 630	29
SC650M-9	23	210	1 800	6 350	29
SC925M-0	40	110	4.5	29	27
SC925M-1	40	110	14	90	27
SC925M-2	40	110	40	272	27
SC925M-3	40	110	113	726	27
SC925M-4	40	110	340	2 088	27
MC3325M-0	25	155	3	11	42
MC3325M-1	25	155	9	40	42
MC3325M-2	25	155	30	120	42
MC3325M-3	25	155	100	420	42
MC3325M-4	25	155	350	1 420	42
MC3350M-0	50	310	5	22	42
MC3350M-1	50	310	18	70	42
MC3350M-2	50	310	60	250	42
MC3350M-3	50	310	210	840	42
MC3350M-4	50	310	710	2 830	42

Capacity Chart

Type Part Number	Stroke mm	Energy Capacity W ₃ Nm/Cycle	Effective Weight Self-Compensating		Page
			me min. kg	me max. kg	
MC4525M-0	25	340	7	27	44
MC4525M-1	25	340	20	90	44
MC4525M-2	25	340	80	310	44
MC4525M-3	25	340	260	1 050	44
MC4525M-4	25	340	890	3 540	44
MC4550M-0	50	680	13	54	44
MC4550M-1	50	680	45	180	44
MC4550M-2	50	680	150	620	44
MC4550M-3	50	680	520	2 090	44
MC4550M-4	50	680	1 800	7 100	44
MC4575M-0	75	1 020	20	80	44
MC4575M-1	75	1 020	70	270	44
MC4575M-2	75	1 020	230	930	44
MC4575M-3	75	1 020	790	3 140	44
MC4575M-4	75	1 020	2 650	10 600	44
MC6450M-0	50	1 700	35	140	46
MC6450M-1	50	1 700	140	540	46
MC6450M-2	50	1 700	460	1 850	46
MC6450M-3	50	1 700	1 600	6 300	46
MC6450M-4	50	1 700	5 300	21 200	46
MC64100M-0	100	3 400	70	280	46
MC64100M-1	100	3 400	270	1 100	46
MC64100M-2	100	3 400	930	3 700	46
MC64100M-3	100	3 400	3 150	12 600	46
MC64100M-4	100	3 400	10 600	42 500	46
MC64150M-0	150	5 100	100	460	46
MC64150M-1	150	5 100	410	1 640	46
MC64150M-2	150	5 100	1 390	5 600	46
MC64150M-3	150	5 100	4 700	18 800	46
MC64150M-4	150	5 100	16 000	63 700	46
SC4525M-5	25	340	3 400	6 800	53
SC4525M-6	25	340	6 350	13 600	53
SC4525M-7	25	340	12 700	22 679	53
SC4525M-8	25	340	20 411	39 000	53
SC4550M-5	50	680	6 800	12 246	53
SC4550M-6	50	680	11 790	26 988	53
SC4550M-7	50	680	25 854	44 225	53
CA2X2-1	50	3 600	700	2 200	59
CA2X2-2	50	3 600	1 800	5 400	59
CA2X2-3	50	3 600	4 500	13 600	59
CA2X2-4	50	3 600	11 300	3 400	59
CA2X4-1	102	7 200	1 400	4 400	59
CA2X4-2	102	7 200	3 600	11 000	59
CA2X4-3	102	7 200	9 100	27 200	59
CA2X4-4	102	7 200	22 600	6 800	59
CA2X6-1	152	10 800	2 200	6 500	59
CA2X6-2	152	10 800	5 400	16 300	59
CA2X6-3	152	10 800	13 600	40 800	59
CA2X6-4	152	10 800	34 000	102 000	59
CA2X8-1	203	14 500	2 900	8 700	59
CA2X8-2	203	14 500	7 200	21 700	59
CA2X8-3	203	14 500	18 100	54 400	59
CA2X8-4	203	14 500	45 300	136 000	59
CA2X10-1	254	18 000	3 600	11 000	59
CA2X10-2	254	18 000	9 100	27 200	59
CA2X10-3	254	18 000	22 600	68 000	59
CA2X10-4	254	18 000	56 600	170 000	59
CA3X5-1	127	14 125	2 900	8 700	60
CA3X5-2	127	14 125	7 250	21 700	60
CA3X5-3	127	14 125	18 100	54 350	60
CA3X5-4	127	14 125	45 300	135 900	60
CA3X8-1	203	22 600	4 650	13 900	60
CA3X8-2	203	22 600	11 600	34 800	60
CA3X8-3	203	22 600	29 000	87 000	60
CA3X8-4	203	22 600	72 500	217 000	60
CA3X12-1	305	33 900	6 950	20 900	60
CA3X12-2	305	33 900	17 400	52 200	60
CA3X12-3	305	33 900	43 500	130 450	60
CA3X12-4	305	33 900	108 700	326 000	60
CA4X6-3	152	47 500	3 500	8 600	61
CA4X6-5	152	47 500	8 600	18 600	61
CA4X6-7	152	47 500	18 600	42 700	61
CA4X8-3	203	63 300	5 000	11 400	61
CA4X8-5	203	63 300	11 400	25 000	61
CA4X8-7	203	63 300	25 000	57 000	61
CA4X16-3	406	126 500	10 000	23 000	61
CA4X16-5	406	126 500	23 000	50 000	61
CA4X16-7	406	126 500	50 000	115 000	61

Issue 7.2014. Specifications subject to change



Shock Absorber Capacity Chart

Adjustable Shock Absorbers

Capacity Chart

Type Part Number	Stroke mm	Max. Energy Capacity Nm		Effective Weight me		Page
		W ₃ Nm/Cycle	W ₄ Nm/h	Adjustable		
				me min. kg	me max. kg	
MA30M	8	3.5	5 650	0.23	15	31
FA1008VD-B	8	1.8	3 600	0.2	10	31
MA50M	7	5.5	13 550	4.5	20	31
MA35M	10	4	6 000	6	57	31
MA150M	12	22	35 000	1	109	31
MA225M	19	25	45 000	2.3	226	31
MA600M	25	68	68 000	9	1 360	31
MA900M	40	100	90 000	14	2 040	31
MA3325M	25	170	75 000	9	1 700	42
ML3325M	25	170	75 000	300	50 000	42
MA3350M	50	340	85 000	13	2 500	42
ML3350M	50	340	85 000	500	80 000	42
MA4525M	25	390	107 000	40	10 000	44
ML4525M	25	390	107 000	3 000	110 000	44
MA4550M	50	780	112 000	70	14 500	44
ML4550M	50	780	112 000	5 000	180 000	44
MA4575M	75	1 170	146 000	70	15 000	44
ML6425M	25	1 020	124 000	7 000	300 000	46
MA6450M	50	2 040	146 000	220	50 000	46
ML6450M	50	2 040	146 000	11 000	500 000	46
MA64100M	100	4 080	192 000	270	52 000	46
MA64150M	150	6 120	248 000	330	80 000	46
A1½X2	50	2 350	362 000	195	32 000	58
A1½X3½	89	4 150	633 000	218	36 000	58
A1½X5	127	5 900	904 000	227	41 000	58
A1½X6½	165	7 700	1 180 000	308	45 000	58
A2X2	50	3 600	1 100 000	250	77 000	59
A2X4	102	9 000	1 350 000	250	82 000	59
A2X6	152	13 500	1 600 000	260	86 000	59
A2X8	203	19 200	1 900 000	260	90 000	59
A2X10	254	23 700	2 200 000	320	113 000	59
A3X5	127	15 800	2 260 000	480	154 000	60
A3X8	203	28 200	3 600 000	540	181 500	60
A3X12	305	44 000	5 400 000	610	204 000	60

ACE miniature shock absorbers are maintenance-free, self-contained hydraulic components. The model range **MC5 to MC75** have a very short overall length and a low return force. The shock absorber is filled with a temperature stable oil and has an integrated positive stop. They are ideally suited for small, fast, handling equipment, rotary actuators, pick and place mechanisms and similar small automation equipment. A wide choice of metering hardnesses enable these units to cover applications with effective weights ranging from 0.3 kg to 72 kg.

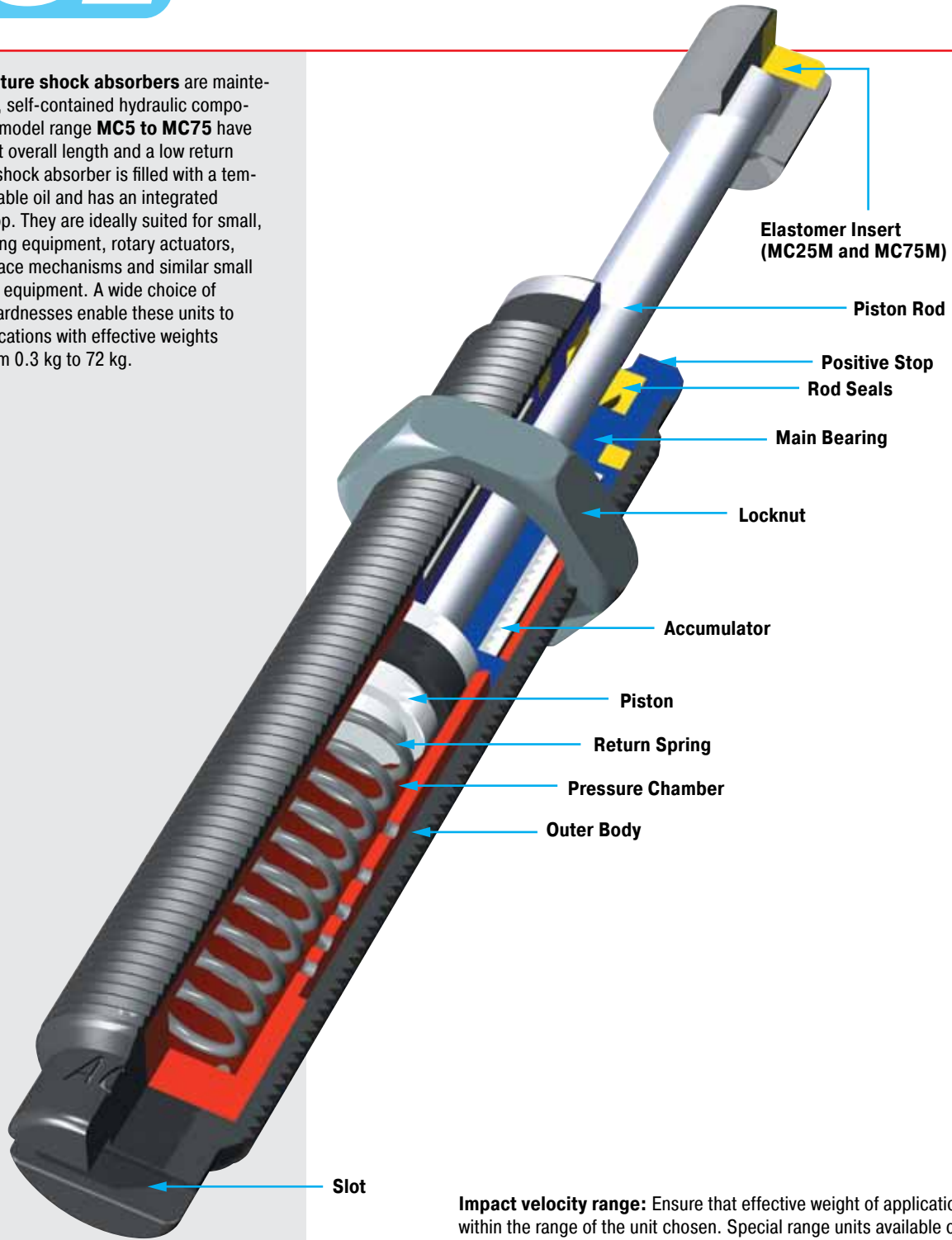

Impact velocity range: Ensure that effective weight of application is within the range of the unit chosen. Special range units available on request.

Material: Shock absorber body: Steel with black oxide finish or nitride hardened. Accessories: Steel with black oxide finish or nitride hardened. Piston rod: Hardened stainless steel. Locknut MC5 and MC9: Aluminium.

W₄ capacity rating: (max. energy per hour Nm/hr) If your application exceeds the tabulated W₄ figures consider additional cooling i.e. cylinder exhaust air etc. Ask ACE for further details.

Mounting: In any position. If precise end position datum is required consider use of the optional stop collar type AH.

Operating temperature range: 0 °C to 66 °C

On request: Weartec finish (seawater resistant). Other finishes available to special order.



ACE miniature shock absorbers are maintenance-free, self-contained hydraulic components. The hermetically sealed rolling diaphragm seal system used on the **MC150 to MC600** model range provides the **highest possible cycle lifetime; up to 25 million cycles being achievable**. All models incorporate an integral positive stop. The rolling diaphragm seal provides an extremely low rod return force. These models can be directly mounted into the end cover of pneumatic cylinders (up to 7 bar) to provide superior end damping compared to normal cylinder cushions. By adding the optional side load adaptor it is possible to accept side loads up to 25° from the axis. The wide range of models available ensure a seamless range of operation on applications with effective weights ranging from 0.9 kg up to 4536 kg by selecting the appropriate model.

"Rolling diaphragm seal system – up to 25 million cycles possible!"

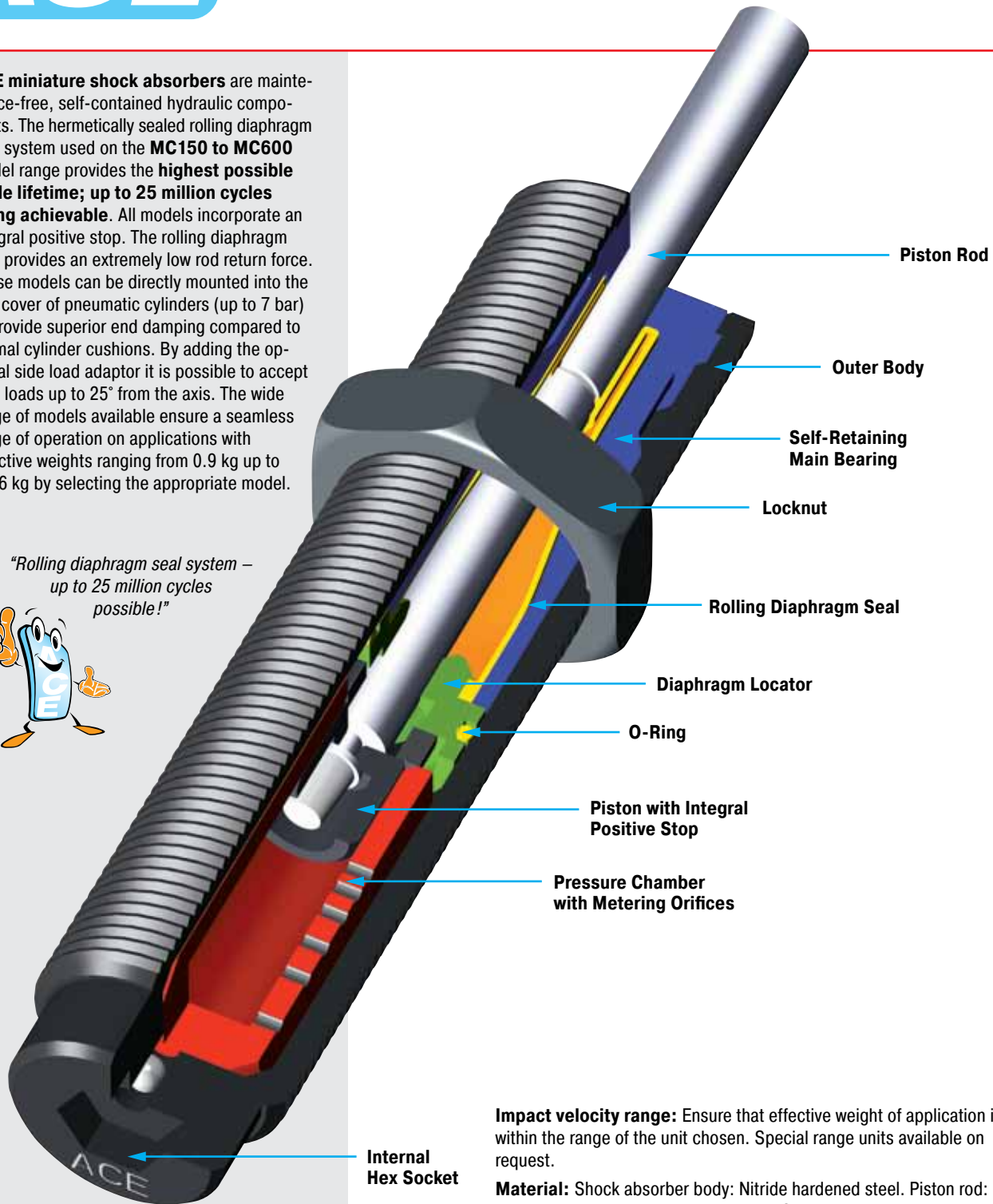

Impact velocity range: Ensure that effective weight of application is within the range of the unit chosen. Special range units available on request.

Material: Shock absorber body: Nitride hardened steel. Piston rod: Hardened stainless steel. Accessories: Steel with black oxide finish or nitride hardened. Rolling diaphragm seal: EPDM.

Note: Local contamination can effect the rolling seal and reduce the lifetime. Please contact ACE for a suitable solution.

W₄ capacity rating: (max. energy per hour Nm/hr) If your application exceeds the tabulated W₄ figures consider additional cooling i. e. cylinder exhaust air etc. Ask ACE for further details.

Mounting: In any position. If precise end position datum is required consider use of the optional stop collar type AH.

Operating temperature range: 0 °C to 66 °C

On request: Weartec finish (seawater resistant). Other finishes available to special order.



MC150M

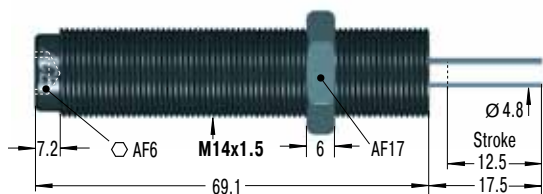

M14x1 also available to special order
Accessories, mounting, installation ... see pages 35 to 39.

PP150

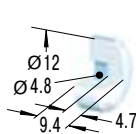

Nylon Button
W₃ max = 14 Nm

RF14

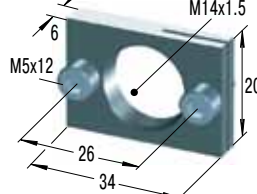

Rectangular Flange

MB14

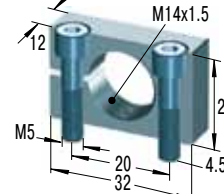

Clamp Mount

MC225M

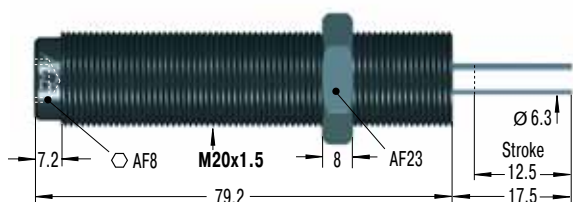

Accessories, mounting, installation ... see pages 36 to 39.

PP225

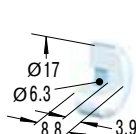

Nylon Button
W₃ max = 33 Nm

RF20

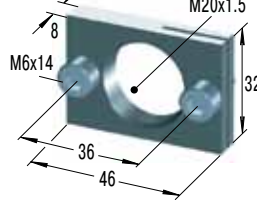

Rectangular Flange

MB20

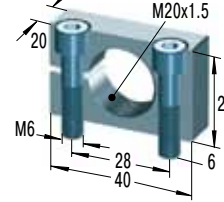

Clamp Mount

MC600M

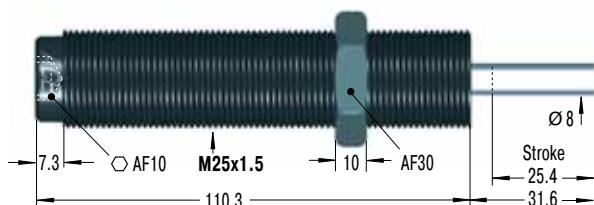

M27x3 also available to special order
Accessories, mounting, installation ... see pages 36 to 39.

PP600

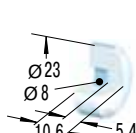

Nylon Button
W₃ max = 68 Nm

RF25

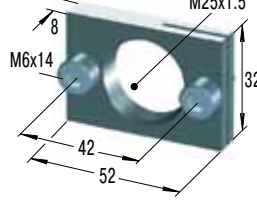

Rectangular Flange

MB25

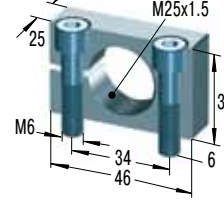

Clamp Mount

Capacity Chart

Type Part Number	Max. Energy Capacity		Effective Weight me Self-Compensating		Min. Return Force N	Max. Return Force N	Rod Reset Time s	1 Max. Side Load Angle °	Weight kg
	W ₃ Nm/Cycle	W ₄ Nm/h	me min. kg	me max. kg					
MC150M	20	34 000	0.9	10	3	8	0.4	4	0.06
MC150MH	20	34 000	8.6	86	3	8	0.4	4	0.06
MC150MH2	20	34 000	70	200	3	8	0.4	4	0.06
MC150MH3	20	34 000	181	408	3	8	1	4	0.06
MC225M	41	45 000	2.3	25	4	9	0.3	4	0.15
MC225MH	41	45 000	23	230	4	9	0.3	4	0.15
MC225MH2	41	45 000	180	910	4	9	0.3	4	0.15
MC225MH3	41	45 000	816	1 814	4	9	0.3	4	0.15
MC600M	136	68 000	9	136	5	10	0.6	2	0.26
MC600MH	136	68 000	113	1 130	5	10	0.6	2	0.26
MC600MH2	136	68 000	400	2 300	5	10	0.6	2	0.26
MC600MH3	136	68 000	2 177	4 536	5	10	0.6	2	0.26

¹ For applications with higher side load angles consider using the side load adaptor (BV) pages 35 to 38.

Based on the proven damping technology of the MC150 to 600 series, these self-adjusting ACE miniature shock absorbers are offered in stainless steel. The outer body, hardened piston rod and all accessories are made of V4A (material 1.4404). The **MC150 to MC600-V4A series** is therefore ideally suited for applications in medical technology, the food and packaging industry, electronics, dock side installations and marine industries. These special dampers offer all the advantages of the MC standard series. The ACE rolling seal membrane achieves the longest lifetime of any shock absorber and can withstand up to 7 bars when directly mounted into a pressure chamber. The wide range of models available ensure a seamless range of operation on applications with effective weights from 0.9 to 4536 kg. With an integrated positive stop and accessories also in V4A this range allows for many different application possibilities. By using the option to fill types MC150 to 600 with special oil that fulfils the requirements (NSF-H1) of the food industry there is a ready made shock absorber system ideally suited to the food processing and packaging industry.



"Also available with special oil suited for the food industry!"

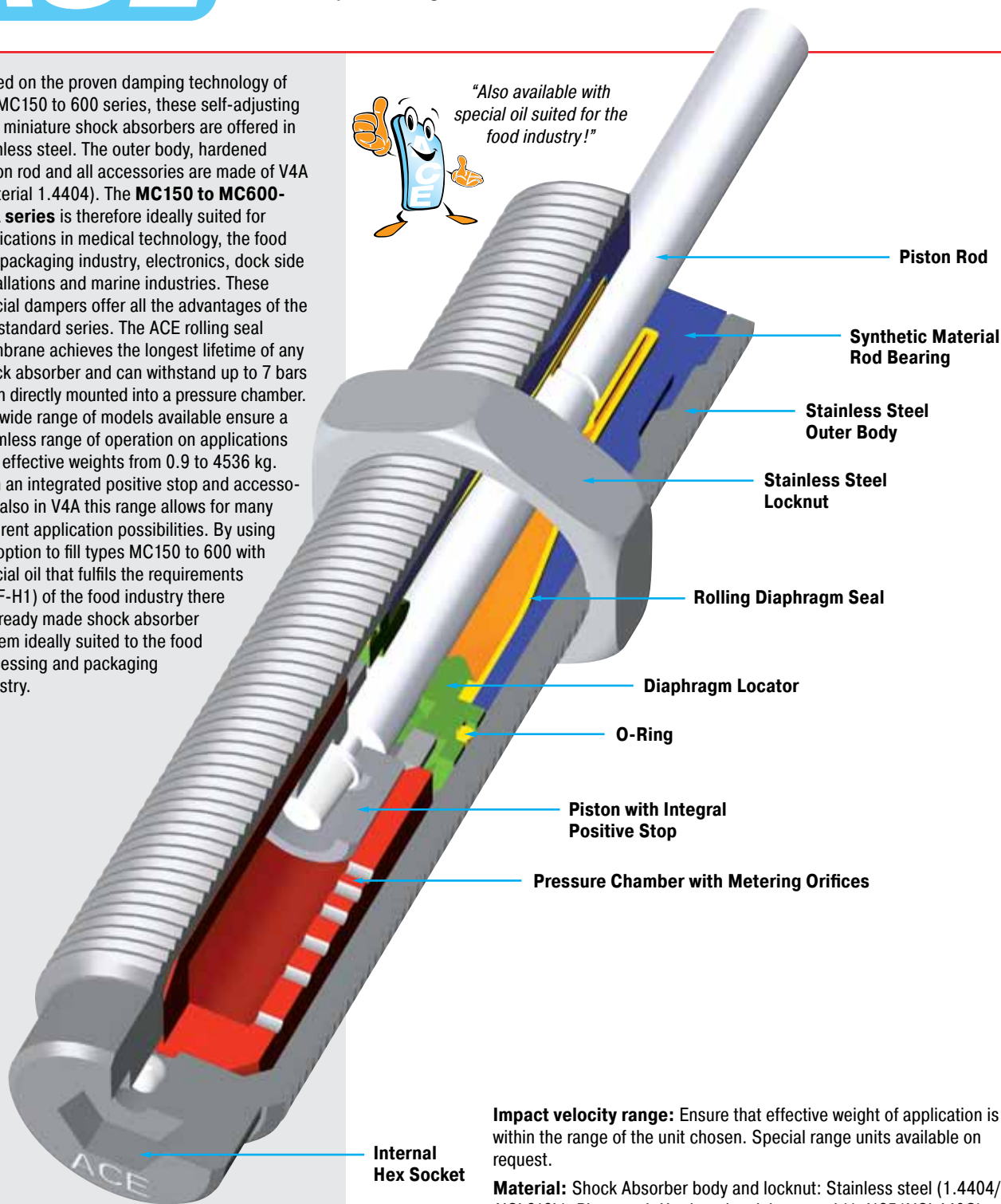

Impact velocity range: Ensure that effective weight of application is within the range of the unit chosen. Special range units available on request.

Material: Shock Absorber body and locknut: Stainless steel (1.4404/AISI 316L). Piston rod: Hardened stainless steel (1.4125/AISI 440C). Rolling diaphragm seal: EPDM. Accessories: Stainless steel (1.4404/AISI 316L).

Note: Local contamination can affect the rolling seal and reduce the lifetime. Please contact ACE for a suitable solution.

W₄ capacity rating: (max. energy per hour Nm/hr) If your application exceeds the tabulated W₄ figures consider additional cooling i. e. cylinder exhaust air etc. Ask ACE for further details.

Mounting: In any position. If precise end position datum is required consider use of the optional stop collar type AH.

Operating temperature range: 0 °C to 66 °C

On request: Special oils, seals and special accessories.



MC150M-V4A

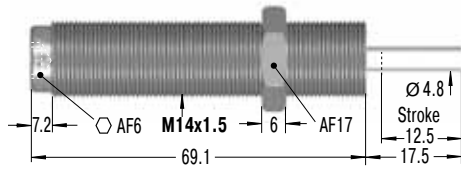

PP150

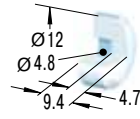

Nylon Button
W₃ max = 14 Nm

AH14-V4A

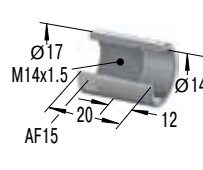

Stop Collar

MB14SC2-V4A

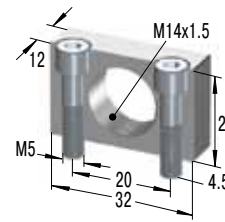

Mounting Block

KM14-V4A



Locknut

MC225M-V4A

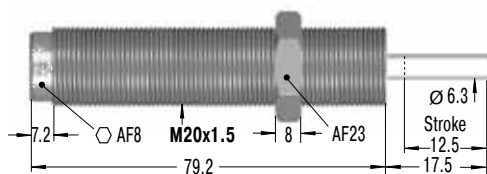

PP225

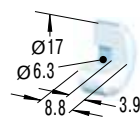

Nylon Button
W₃ max = 33 Nm

AH20-V4A

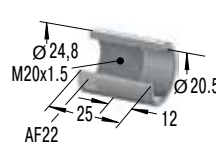

Stop Collar

MB20SC2-V4A

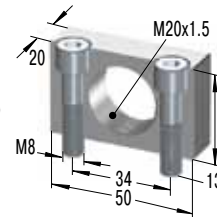

Mounting Block

KM20-V4A



Locknut

MC600M-V4A

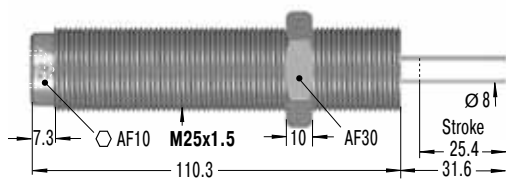

PP600

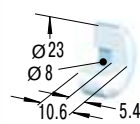

Nylon Button
W₃ max = 68 Nm

AH25-V4A

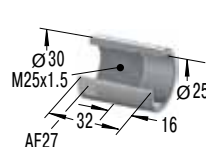

Stop Collar

MB25SC2-V4A

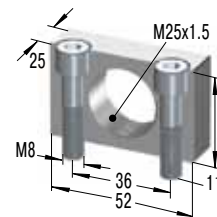

Mounting Block

KM25-V4A



Locknut

Capacity Chart

Type Part Number	Max. Energy Capacity		Effective Weight me Self-Compensating		Min. Return Force N	Max. Return Force N	Rod Reset Time s	1 Max. Side Load Angle °	Weight kg
	W ₃ Nm/Cycle	W ₄ Nm/h	me min. kg	me max. kg					
MC150M-V4A	20	34 000	0.9	10	3	5	0.4	4	0.06
MC150MH-V4A	20	34 000	8.6	86	3	5	0.4	4	0.06
MC150MH2-V4A	20	34 000	70	200	3	5	0.4	4	0.06
MC150MH3-V4A	20	34 000	181	408	3	5	1	4	0.06
MC225M-V4A	41	45 000	2.3	25	4	6	0.3	4	0.15
MC225MH-V4A	41	45 000	23	230	4	6	0.3	4	0.15
MC225MH2-V4A	41	45 000	180	910	4	6	0.3	4	0.15
MC225MH3-V4A	41	45 000	816	1 814	4	6	0.3	4	0.15
MC600M-V4A	136	68 000	9	136	5	9	0.6	2	0.26
MC600MH-V4A	136	68 000	113	1 130	5	9	0.6	2	0.26
MC600MH2-V4A	136	68 000	400	2 300	5	9	0.6	2	0.26
MC600MH3-V4A	136	68 000	2 177	4 536	5	9	0.6	2	0.26

¹ For applications with higher side load angles please contact ACE.

These new ACE shock absorbers of the Protection series PMC were designed for applications with particular fluid requirements. The special protective cap made of PTFE (Teflon) hermetically seals the entire damping system (the proven rolling seal) against outside influences. Aggressive cutting, cooling, or cleaning agents are thus not able to contaminate the shocks inside the system. A stainless steel button integrated in the cap absorbs the impact energy reliably and establishes longest lifetimes for the shock absorber. The new Protection series offers the perfect alternative to the ACE air bleed collar of the SP series, when the machine or equipment does not possess its own compressed air. The Protection series is available for thread sizes M14 to M25 and can find applications in all those environments where common shock absorbers cannot be used because of aggressive fluids. The Protection series is of special interest for the food industry as the shocks can be delivered with a V4A stainless (material number 1.4404) steel outer body.

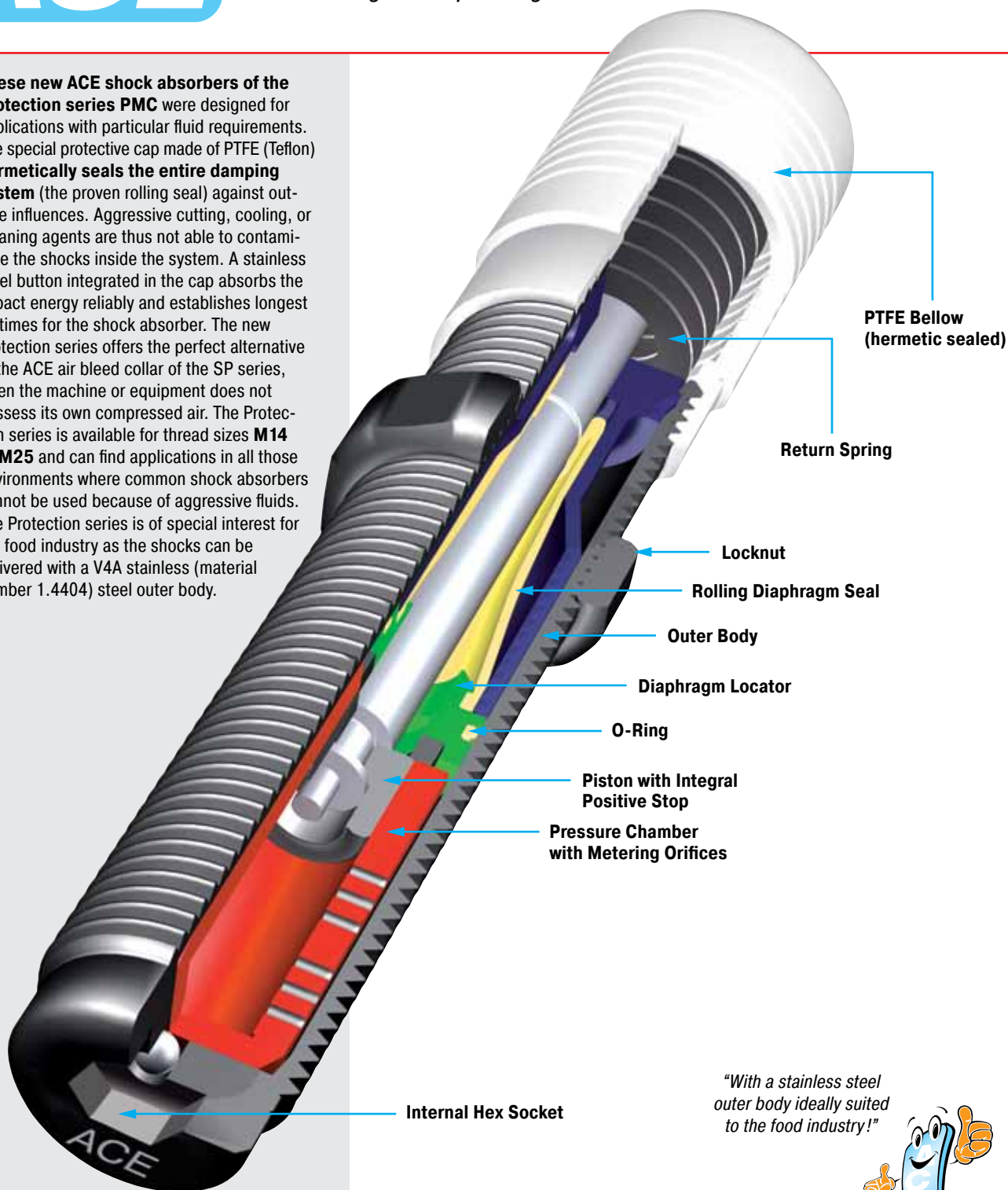

"With a stainless steel outer body ideally suited to the food industry!"



Impact velocity range: Ensure that effective weight of application is within the range of the unit chosen. Special range units available on request.

Material: Bellow: PTFE. Steel insert: Stainless Steel 1.4404/AISI 316L. Shock absorber body: Nitride hardened steel or stainless steel 1.4404/AISI 316L.

Note: Final preliminary test must be done on the application.

Mounting: In any position

Operating temperature range: 0 °C to 66 °C



PMC150M

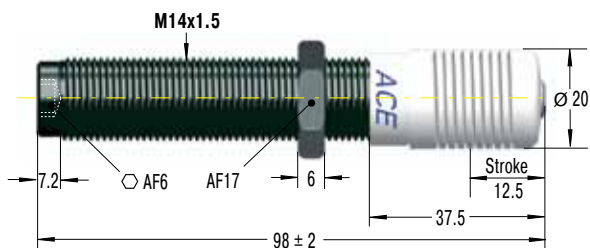

PMC150M-V4A



Dimensions as PMC150M

PMC225M

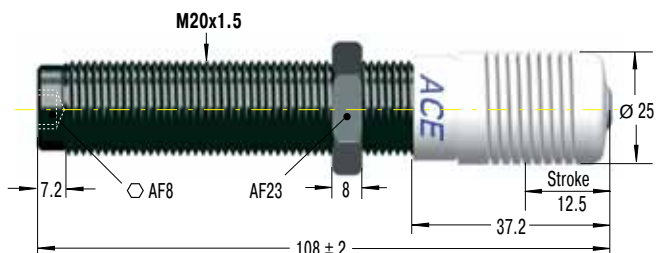

PMC225M-V4A



Dimensions as PMC225M

PMC600M

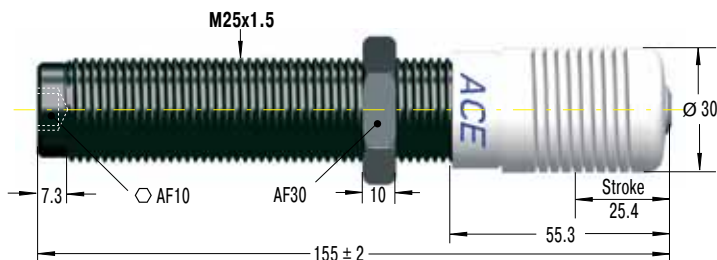

PMC600M-V4A



Dimensions as PMC600M

Capacity Chart

Type Part Number	Max. Energy Capacity		Effective Weight me Self-Compensating		Min. Return Force N	Max. Return Force N	Rod Reset Time s	Max. Side Load Angle °	Weight kg
	W ₃ Nm/Cycle	W ₄ Nm/h	me min. kg	me max. kg					
PMC150M	20	34 000	0.9	10	5	60	0.4	4	0.08
PMC150MH	20	34 000	8.6	86	5	60	0.4	4	0.08
PMC150MH2	20	34 000	70	200	5	60	0.4	4	0.08
PMC150MH3	20	34 000	181	408	5	60	1	4	0.08
PMC225M	41	45 000	2.3	25	5	65	0.3	4	0.17
PMC225MH	41	45 000	23	230	5	65	0.3	4	0.17
PMC225MH2	41	45 000	180	910	5	65	0.3	4	0.17
PMC225MH3	41	45 000	816	1 814	5	65	0.3	4	0.17
PMC600M	136	68 000	9	136	5	85	0.6	2	0.32
PMC600MH	136	68 000	113	1 130	5	85	0.6	2	0.32
PMC600MH2	136	68 000	400	2 300	5	85	0.6	2	0.32
PMC600MH3	136	68 000	2 177	4 536	5	85	0.6	2	0.32

Type V4A

PMC150M-V4A	20	34 000	0.9	10	5	60	0.4	4	0.08
PMC150MH-V4A	20	34 000	8.6	86	5	60	0.4	4	0.08
PMC150MH2-V4A	20	34 000	70	200	5	60	0.4	4	0.08
PMC150MH3-V4A	20	34 000	181	408	5	60	1	4	0.08
PMC225M-V4A	41	45 000	2.3	25	5	65	0.3	4	0.17
PMC225MH-V4A	41	45 000	23	230	5	65	0.3	4	0.17
PMC225MH2-V4A	41	45 000	180	910	5	65	0.3	4	0.17
PMC225MH3-V4A	41	45 000	816	1 814	5	65	0.3	4	0.17
PMC600M-V4A	136	68 000	9	136	5	85	0.6	2	0.32
PMC600MH-V4A	136	68 000	113	1 130	5	85	0.6	2	0.32
PMC600MH2-V4A	136	68 000	400	2 300	5	85	0.6	2	0.32
PMC600MH3-V4A	136	68 000	2 177	4 536	5	85	0.6	2	0.32

Issue 7.2014. Specifications subject to change

ACE miniature shock absorbers are maintenance-free, self-contained hydraulic components. The SC-Series provide dual performance benefits. They provide “soft contact” deceleration where initial impact reaction forces are very low with the advantages of self-compensation to cope with changing input energy conditions without adjustment. They have long stroke lengths to provide smooth deceleration and low reaction forces. They have an integrated mechanical stop and are ideal for use on handling equipment, linear transfers, rodless cylinders and pneumatic pick and place systems etc. The overlapping operating ranges enable the SC series to handle effective weights ranging 0.7 kg up to 2088 kg. With the optional side load adaptor fitted they can cope with the side loads up to 25°.

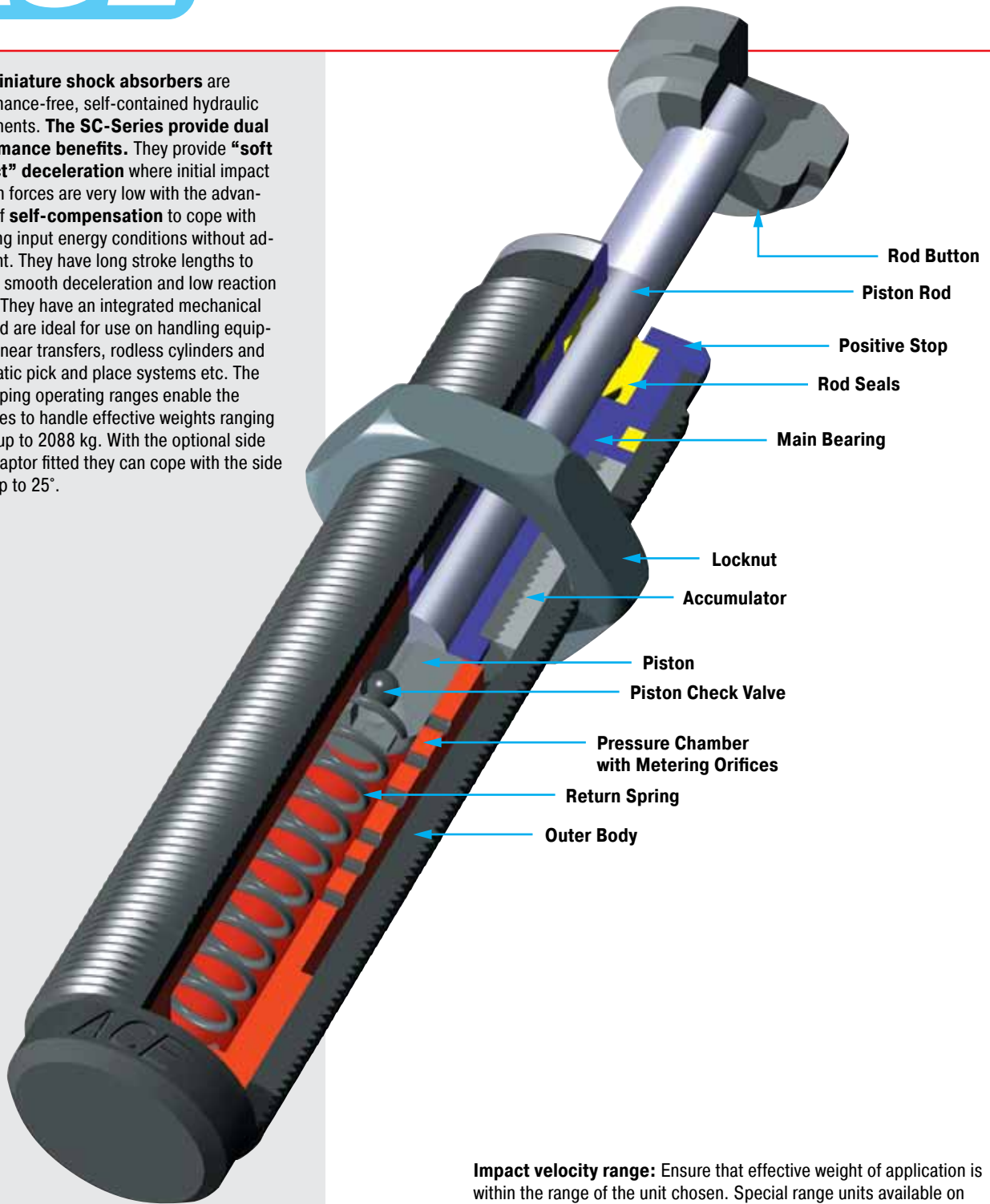

Impact velocity range: Ensure that effective weight of application is within the range of the unit chosen. Special range units available on request.

Material: Shock absorber body: Nitride hardened steel. Accessories: Steel with black oxide finish or nitride hardened. Piston rod: Hardened stainless steel.

W₄ capacity rating: (max. energy per hour Nm/hr) If your application exceeds the tabulated W₄ figures consider additional cooling i. e. cylinder exhaust air etc. Ask ACE for further details.

Mounting: In any position. If precise end position datum is required consider use of the optional stop collar type AH.

Operating temperature range: 0 °C to 66 °C

On request: Weartec finish (seawater resistant). Other special finishes available to special order.



SC190M

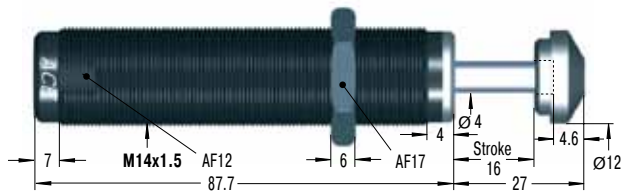

M14x1 and M16x1 also available to special order
Accessories, mounting, installation ... see pages 35 to 39.

SC300M

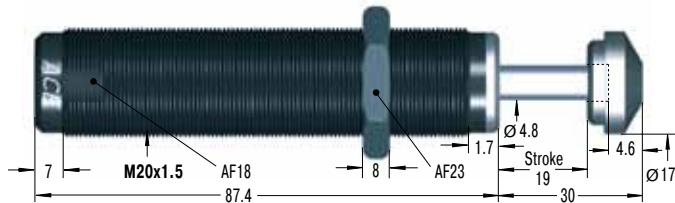

M22x1.5 also available to special order
Accessories, mounting, installation ... see pages 36 to 39.

SC650M

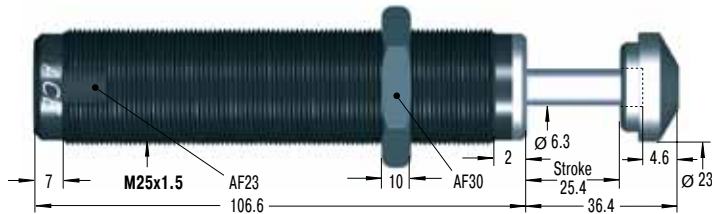

M26x1.5 also available to special order
Accessories, mounting, installation ... see pages 36 to 39.

SC925M

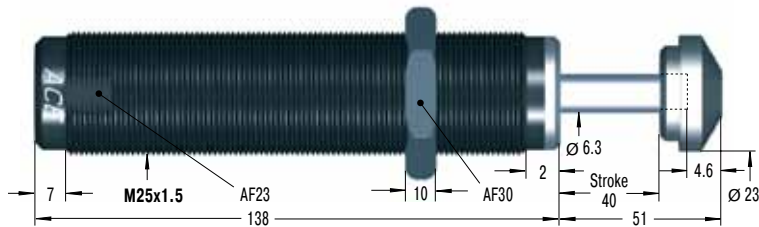

Accessories, mounting, installation ... see pages 36 to 39.

Available without rod end button on request.

Capacity Chart

Type Part Number	Max. Energy Capacity		Effective Weight me				Min. Return Force N	Max. Return Force N	Rod Reset Time s	1 Max. Side Load Angle °	Weight kg
	W ₃ Nm/Cycle	W ₄ Nm/h	Soft-Contact me min. kg	Soft-Contact me max. kg	Self-Compensating me min. kg	Self-Compensating me max. kg					
SC190M-0	25	34 000	—	—	0.7	4	4	9	0.25	5	0.08
SC190M-1	25	34 000	2.3	6	1.4	7	4	9	0.25	5	0.08
SC190M-2	25	34 000	5.5	16	3.6	18	4	9	0.25	5	0.08
SC190M-3	25	34 000	14	41	9	45	4	9	0.25	5	0.08
SC190M-4	25	34 000	34	91	23	102	4	9	0.25	5	0.08
SC300M-0	33	45 000	—	—	0.7	4	5	10	0.1	5	0.11
SC300M-1	33	45 000	2.3	7	1.4	8	5	10	0.1	5	0.11
SC300M-2	33	45 000	7	23	4.5	27	5	10	0.1	5	0.11
SC300M-3	33	45 000	23	68	14	82	5	10	0.1	5	0.11
SC300M-4	33	45 000	68	181	32	204	5	10	0.1	5	0.11
SC650M-0	73	68 000	—	—	2.3	14	11	32	0.2	5	0.31
SC650M-1	73	68 000	11	36	8	45	11	32	0.2	5	0.31
SC650M-2	73	68 000	34	113	23	136	11	32	0.2	5	0.31
SC650M-3	73	68 000	109	363	68	408	11	32	0.2	5	0.31
SC650M-4	73	68 000	363	1 089	204	1 180	11	32	0.2	5	0.31
SC925M-0	110	90 000	8	25	4.5	29	11	32	0.4	5	0.39
SC925M-1	110	90 000	22	72	14	90	11	32	0.4	5	0.39
SC925M-2	110	90 000	59	208	40	272	11	32	0.4	5	0.39
SC925M-3	110	90 000	181	612	113	726	11	32	0.4	5	0.39
SC925M-4	110	90 000	544	1 952	340	2 088	11	32	0.4	5	0.39

1 For applications with higher side load angles consider using the side load adaptor (BV) pages 35 to 38.

RF14

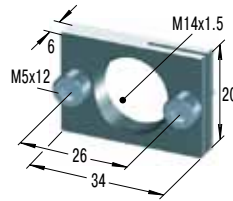

Rectangular Flange

MB14

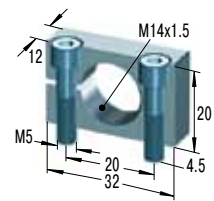

Clamp Mount

RF20

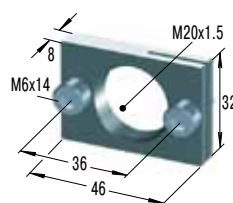

Rectangular Flange

MB20

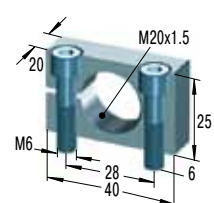

Clamp Mount

RF25

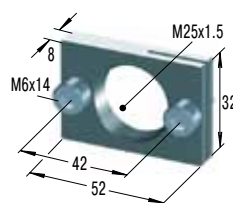

Rectangular Flange

MB25

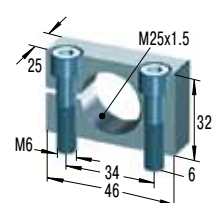

Clamp Mount

RF25

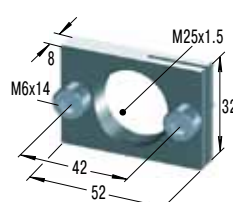

Rectangular Flange

MB25

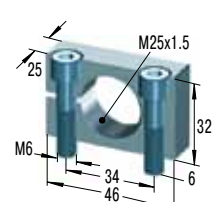

Clamp Mount

ACE miniature shock absorbers are maintenance-free, self-contained hydraulic components. The design of the **SC²-Series** units combines the piston and inner tube into a single component and **provides more than double the energy capacity of previous units in the same envelope size**. They have an integrated mechanical stop and are ideal for use on handling equipment, linear transfers, rodless cylinders, pneumatic pick and place systems and rotation modules etc. The smaller sizes up to type SC²190, have a dynamic membrane seal which allows direct installation into the end cover of pneumatic cylinders (for end position damping max. 7 bar). The greatly increased energy capacity coupled with overlapping effective weight ranges covering from 1 kg up to 6350 kg makes the SC²-Series units ideal for rotary actuators. With the optional side load adaptor fitted they can cope with the side loads up to 25°.

"Combined piston and inner tube – increased energy capacity up to 200 %!"

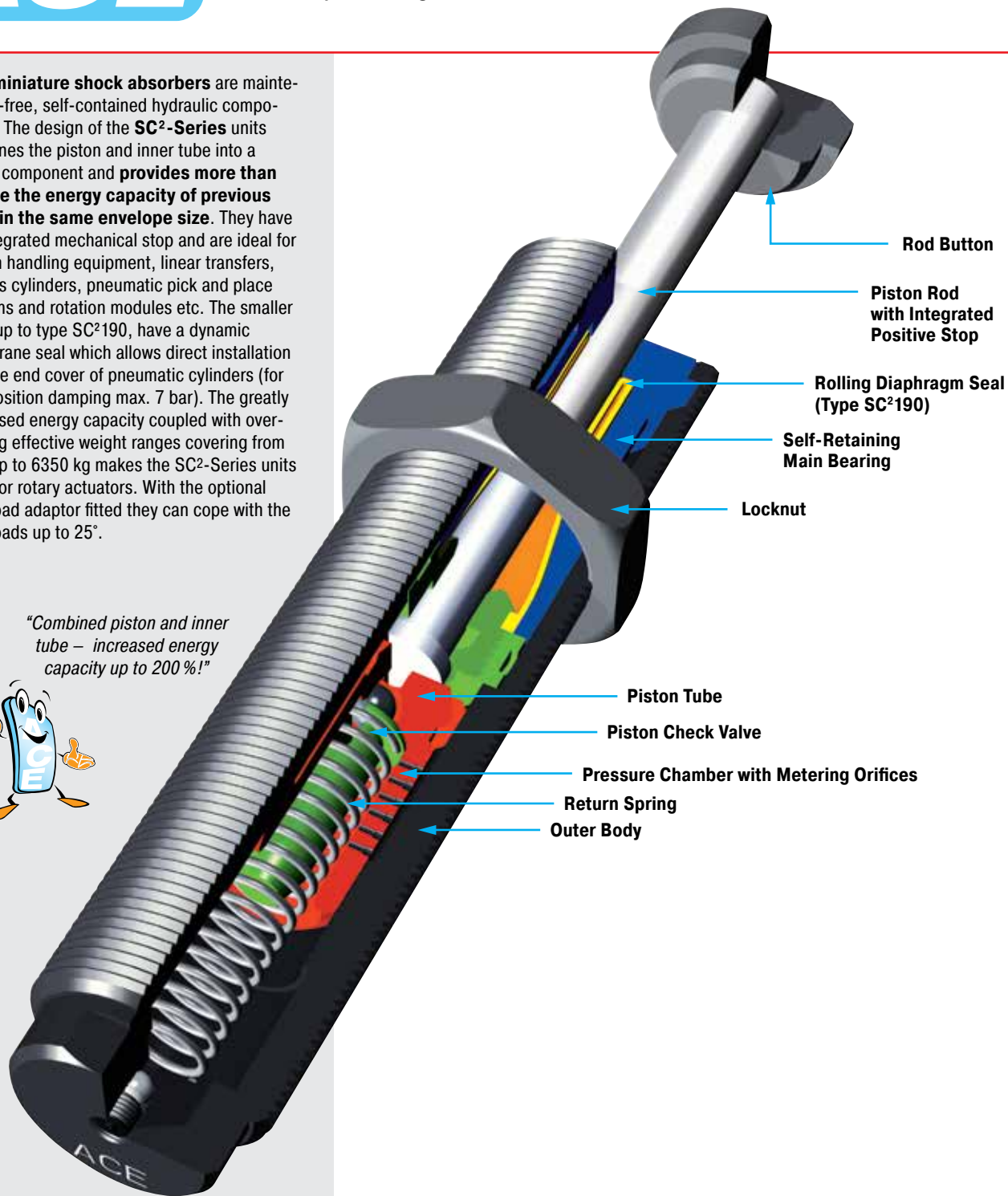

Rod Button

Piston Rod with Integrated Positive Stop

Rolling Diaphragm Seal (Type SC²190)

Self-Retaining Main Bearing

Locknut

Piston Tube

Piston Check Valve

Pressure Chamber with Metering Orifices

Return Spring

Outer Body

Impact velocity range: Ensure that effective weight of application is within the range of the unit chosen. Special range units available on request.

Material: Shock absorber body: Nitride hardened steel. Accessories: Steel with black oxide finish or nitride hardened. Piston rod: Hardened stainless steel.

Mounting: In any position. If precise end position datum is required consider use of the optional stop collar type AH.

Operating temperature range: 0 °C to 66 °C

On request: Models HT (SC²650). Weartec finish (seawater resistant). Other special finishes available to special order.



SC25M

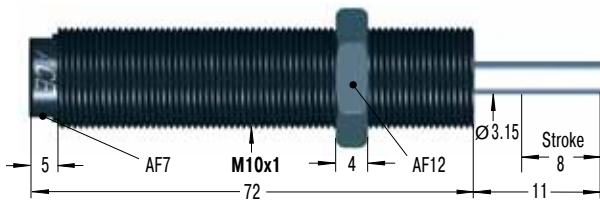

Accessories, mounting, installation ... see pages 34 to 39.

SC75M

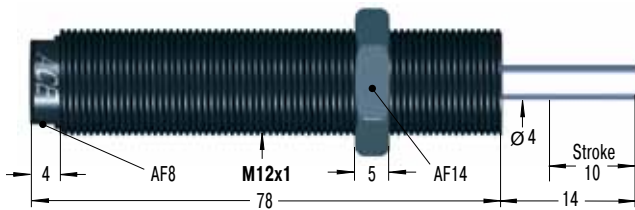

Accessories, mounting, installation ... see pages 35 to 39.

SC190M

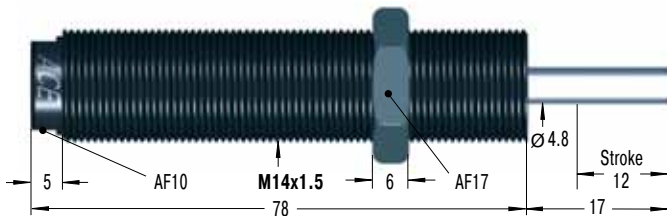

M14x1 also available to special order

Accessories, mounting, installation ... see pages 35 to 39.

SC300M

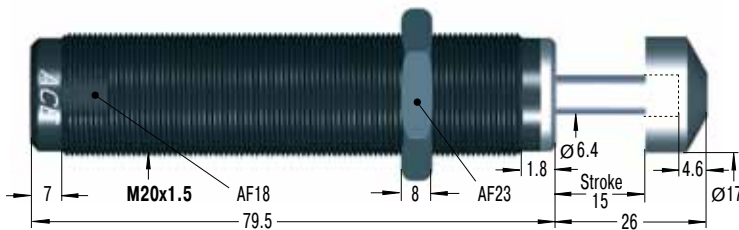

Accessories, mounting, installation ... see pages 36 to 39.

SC650M

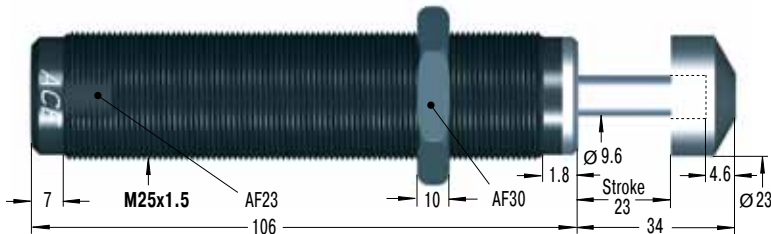

Accessories, mounting, installation ... see pages 36 to 39.

RF10

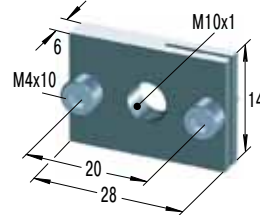

Rectangular Flange

MB10SC2

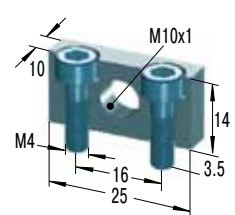

Mounting Block

RF12

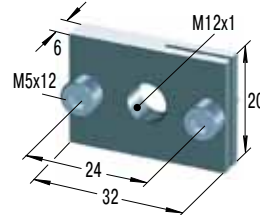

Rectangular Flange

MB12SC2

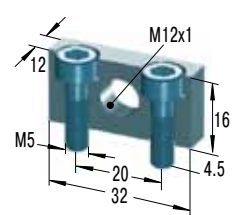

Mounting Block

RF14

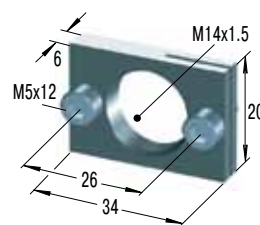

Rectangular Flange

MB14SC2

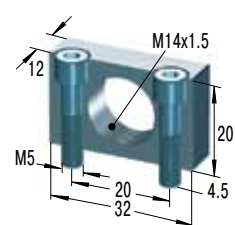

Mounting Block

RF20

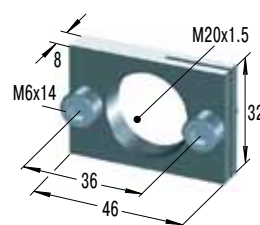

Rectangular Flange

MB20SC2

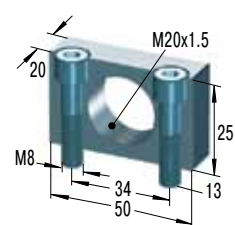

Mounting Block

RF25

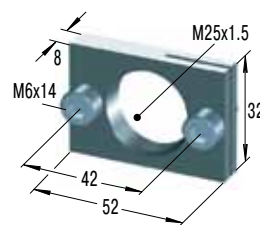

Rectangular Flange

MB25SC2

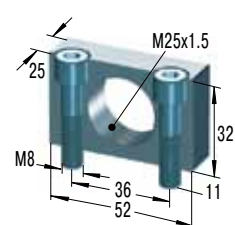

Mounting Block

Issue 7.2014. Specifications subject to change

Capacity Chart

Type	Max. Energy Capacity		Effective Weight me					Min. Return Force N	Max. Return Force N	Rod Reset Time s	1 Max. Side Load Angle °	Weight kg	
	W ₃ Nm/Cycle	W ₄ Nm/h	Soft		Hard								
			min. kg	max. kg	-5 min. kg	-6 min. kg	-7 min. kg						-8 min. kg
SC25M	10	16 000	1	5	4	44	42	500	4.5	14	0.3	2	0.027
SC75M	16	30 000	1	8	7	78	75	800	6	19	0.3	2	0.045
SC190M	31	50 000	2	16	13	140	136	1 550	6	19	0.4	2	0.060
SC300M	73	45 000	11	45	34	136	91	181	8	18	0.2	5	0.164
SC650M	210	68 000	23	113	90	360	320	1 090	11	33	0.3	5	0.315

1 For applications with higher side load angles consider using the side load adaptor (BV) pages 34 to 38.

ACE miniature shock absorbers are maintenance-free, self-contained hydraulic components. If you prefer a fully adjustable shock absorber rather than a self-compensating model on your application then the **MA series** provide a directly interchangeable alternative. The adjustable series include an integrated mechanical stop. These adjustable units have long stroke lengths (MA900 with 40 mm super-stroke) to provide smooth deceleration and low reaction forces. The MA150 incorporates the proven rolling diaphragm seal (used on the MC150 to MC600 range) and shares all the advantages of that technology. The stepless adjustment range of the MA series covers an effective weight range from 0.2 kg up to 2040 kg.

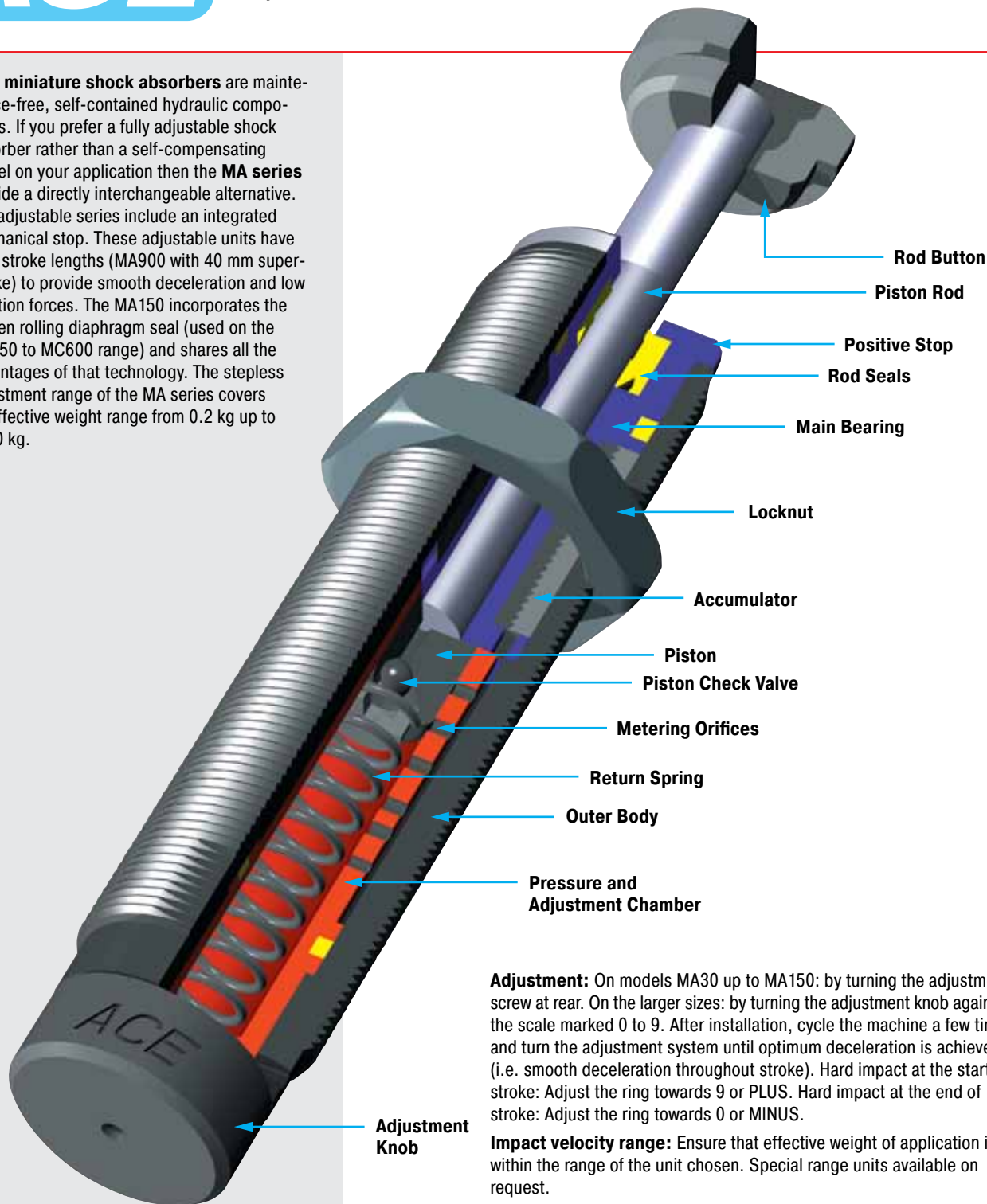

Adjustment: On models MA30 up to MA150: by turning the adjustment screw at rear. On the larger sizes: by turning the adjustment knob against the scale marked 0 to 9. After installation, cycle the machine a few times and turn the adjustment system until optimum deceleration is achieved (i.e. smooth deceleration throughout stroke). Hard impact at the start of stroke: Adjust the ring towards 9 or PLUS. Hard impact at the end of stroke: Adjust the ring towards 0 or MINUS.

Impact velocity range: Ensure that effective weight of application is within the range of the unit chosen. Special range units available on request.

Material: Shock absorber body: Nitride hardened steel. Accessories: Steel with black oxide finish or nitride hardened. Piston rod: Hardened stainless steel.

W₄ capacity rating: (max. energy per hour Nm/hr) If your application exceeds the tabulated W₄ figures consider additional cooling i. e. cylinder exhaust air etc. Ask ACE for further details.

Mounting: In any position. If precise end position datum is required consider use of the optional stop collar type AH. Install a mechanical stop 0.5 to 1 mm before end of stroke on FA1008.

Operating temperature range: 0 °C to 66 °C

On request: Weartec finish (seawater resistant). Other special finishes available to special order.



MA30M

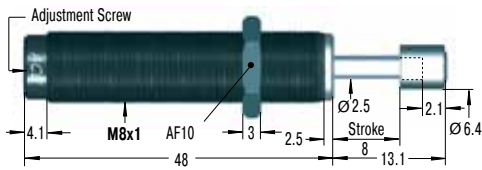

Accessories, mounting, installation ... see pages 34 to 39.

MA50M for use on new installations

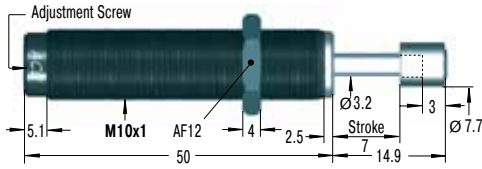

Accessories, mounting, installation ... see pages 34 to 39.

MA35M

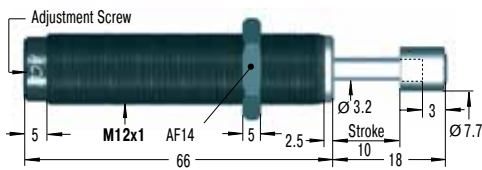

Accessories, mounting, installation ... see pages 35 to 39.

MA150M

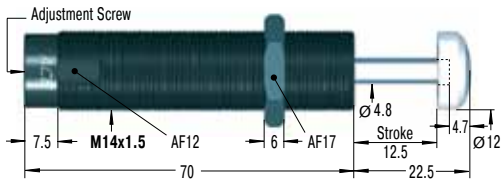

M14x1 also available to special order

Accessories, mounting, installation ... see pages 35 to 39.

MA225M

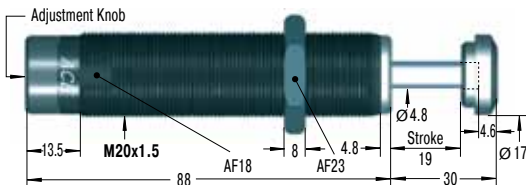

Accessories, mounting, installation ... see pages 36 to 39.

MA600M and MA900M

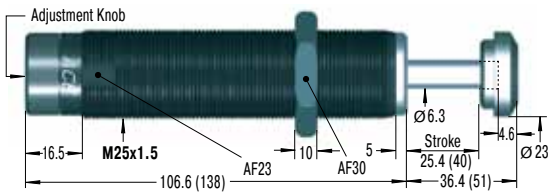

Dimensions for MA900M in ()

MA600ML with M27x3 available to special order

Accessories, mounting, installation ... see pages 36 to 39.

RF8

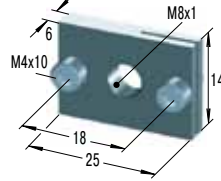

Rectangular Flange

MB8SC2

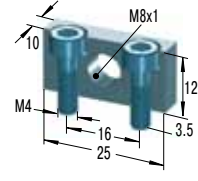

Mounting Block

FA1008VD-B still available in future

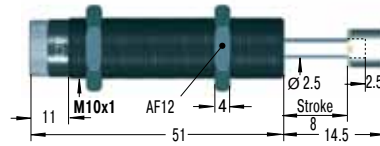

Accessories, mounting, installation ... see pages 34 to 39.

RF12

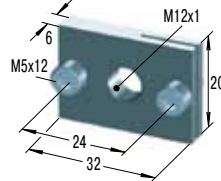

Rectangular Flange

MB12

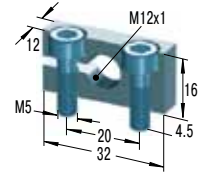

Clamp Mount

RF14

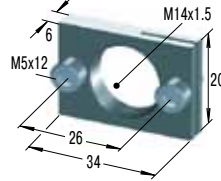

Rectangular Flange

MB14

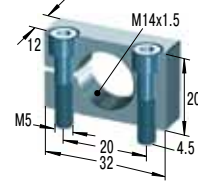

Clamp Mount

RF20

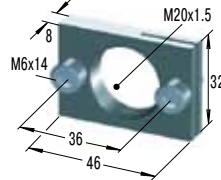

Rectangular Flange

MB20

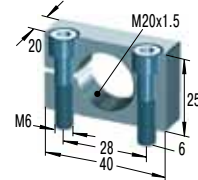

Clamp Mount

RF25

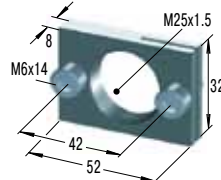

Rectangular Flange

MB25

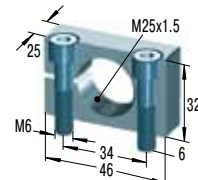

Clamp Mount

Available without rod end button on request. Models MA600M/MA900M available with clevis mounting.

Capacity Chart

Type Part Number	Max. Energy Capacity		Effective Weight me Adjustable		Min. Return Force N	Max. Return Force N	Rod Reset Time s	1 Max. Side Load Angle °	Weight kg
	W ₃ Nm/Cycle	W ₄ Nm/h	me min. kg	me max. kg					
MA30M	3.5	5 650	0.23	15	1.7	5.3	0.3	2	0.013
FA1008VD-B	1.8	3 600	0.2	10	3	6	0.3	2.5	0.026
MA50M	5.5	13 550	4.5	20	3	6	0.3	2	0.025
MA35M	4	6 000	6	57	5	11	0.2	2	0.043
MA150M	22	35 000	1	109	3	5	0.4	2	0.06
MA225M	25	45 000	2.3	226	5	10	0.1	2	0.13
MA600M	68	68 000	9	1 360	10	30	0.2	2	0.31
MA900M	100	90 000	14	2 040	10	35	0.4	1	0.4

1 For applications with higher side load angles consider using the side load adaptor (BV) pages 34 to 38.

Selection Chart for Shock Absorber Accessories



Locknut



Stop Collar



¹ Clamp Mount/
Mounting Block



Rectangular Flange



Universal Mount



² Side Load
Adaptor

Shock Absorber Type

KM

AH

MB

RF

UM

BV

Thread Size M5x0.5

MC5M	KM5	AH5	MB5SC2	-	-	-
------	-----	-----	--------	---	---	---

Thread Size M6x0.5

MC9M	KM6	AH6	MB6SC2	RF6	-	-
------	-----	-----	--------	-----	---	---

Thread Size M8x1

MA30M	KM8	AH8	MB8SC2	RF8	-	BV8
MC10M	KM8	AH8	MB8SC2	RF8	-	BV8A
MC30M	KM8	AH8	MB8SC2	RF8	-	BV8

Thread Size M10x1

FA1008VD-B	KM10	AH10	MB10SC2	RF10	UM10	-
MA50M	KM10	AH10	MB10SC2	RF10	UM10	BV10
MC25M	KM10	AH10	MB10SC2	RF10	UM10	BV10
SC25M	KM10	AH10	MB10SC2	RF10	UM10	BV10SC

Thread Size M12x1

MA35M	KM12	AH12	MB12	RF12	UM12	BV12
MC75M	KM12	AH12	MB12	RF12	UM12	BV12
SC75M	KM12	AH12	MB12SC2	RF12	UM12	BV12SC

Thread Size M14x1.5

MA150M	KM14	AH14	MB14	RF14	UM14	BV14
MC150M	KM14	AH14	MB14	RF14	UM14	BV14
SC190M0-4	KM14	AH14	MB14	RF14	UM14	BV14SC
SC190M5-7	KM14	AH14	MB14SC2	RF14	UM14	BV14

Thread Size M20x1.5

MA225M	KM20	AH20	MB20	RF20	UM20	BV20SC
MC225M	KM20	AH20	MB20	RF20	UM20	BV20
SC300M0-4	KM20	AH20	MB20	RF20	UM20	BV20SC
SC300M5-9	KM20	AH20	MB20SC2	RF20	UM20	BV20SC

Thread Size M25x1.5

MA600M	KM25	AH25	MB25	RF25	UM25	BV25SC
MA900M	KM25	AH25	MB25	RF25	UM25	-
MC600M	KM25	AH25	MB25	RF25	UM25	BV25
SC650M0-4	KM25	AH25	MB25	RF25	UM25	BV25SC
SC650M5-9	KM25	AH25	MB25SC2	RF25	UM25	BV25SC
SC925M	KM25	AH25	MB25	RF25	UM25	-

¹ Use a locknut for protection if a clamp mount MB...SC2 is installed.

² Only mountable on units without button.

Remove the button from the shock absorber, if there's one fitted. See page 38.



² Steel Shroud



Air Bleed Collar



Switch Stop Collar



Steel Button



Steel/Urethane Button



Nylon Button

	PB	SP	AS	PS	BP	PP	Page
Thread Size M5x0.5	-	-	-	-	-	-	34
Thread Size M6x0.5	-	-	-	-	-	-	34
Thread Size M8x1							
PB8	-	-	-	-	-	-	34
PB8-A	-	-	-	-	-	-	34
PB8	-	-	-	-	-	-	34
Thread Size M10x1							
-	-	-	-	-	-	-	34
PB10	-	-	AS10	PS10	-	-	34
PB10	-	-	AS10	PS10	-	-	34
PB10SC	-	-	-	-	-	-	34
Thread Size M12x1							
PB12	-	-	AS12	PS12	-	-	35
PB12	-	-	AS12	PS12	-	-	35
PB12SC	SP12	-	AS12	PS12SC	-	-	35
Thread Size M14x1.5							
PB14	SP14	-	AS14	PS14	-	included	35
PB14	SP14	-	AS14	PS14	-	PP150	35
PB14SC	-	-	AS14	included	BP14	-	35
PB14	SP14	-	AS14	PS14	-	-	35
Thread Size M20x1.5							
PB20SC	-	-	AS20	included	BP20	-	36
PB20	SP20	-	AS20	PS20	-	PP225	36
PB20SC	-	-	AS20	included	BP20	-	36
PB20SC	-	-	AS20	included	-	-	36
Thread Size M25x1.5							
PB25SC	-	-	AS25	included	BP25	-	36
-	-	-	AS25	included	BP25	-	36
PB25	SP25	-	AS25	PS25	-	PP600	36
PB25SC	-	-	AS25	included	BP25	-	36
PB25	-	-	AS25	included	-	-	36
-	-	-	AS25	included	BP25	-	36

² Only mountable on units without button.
Remove the button from the shock absorber, if there's one fitted. See page 38.

Dimensions see pages 34 to 36.

M5x0.5

KM5

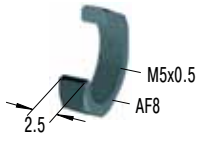

Locknut

AH5

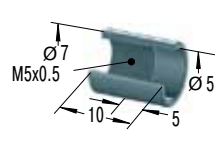

Stop Collar

MB5SC2

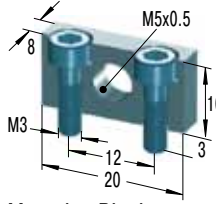

Mounting Block

M6x0.5

KM6



Locknut

AH6

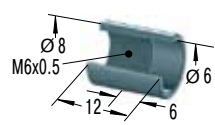

Stop Collar

MB6SC2

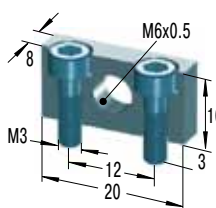

Mounting Block

RF6

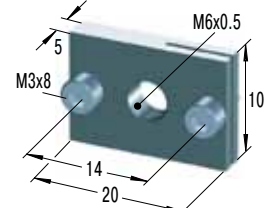

Rectangular Flange

M8x1

KM8



Locknut

AH8

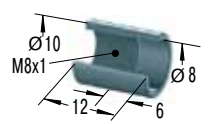

Stop Collar

MB8SC2

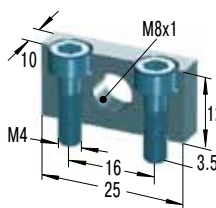

Mounting Block

RF8

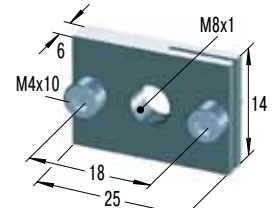

Rectangular Flange

BV8

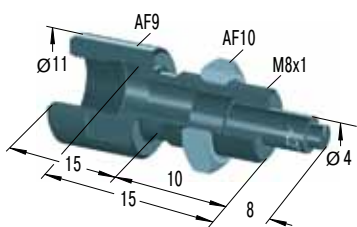

Side Load Adaptor

BV8A

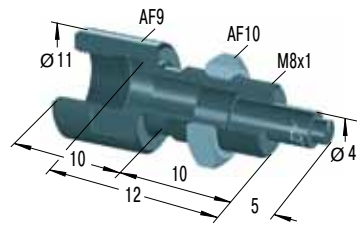

Side Load Adaptor

PB8

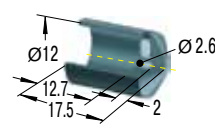

Steel Shroud

PB8-A

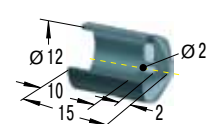

Steel Shroud

M10x1

KM10



Locknut

AH10

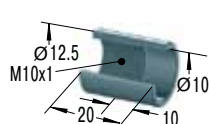

Stop Collar

MB10SC2

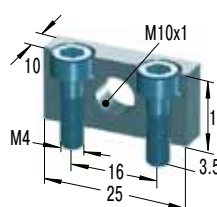

Mounting Block

RF10

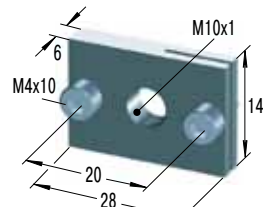

Rectangular Flange

UM10

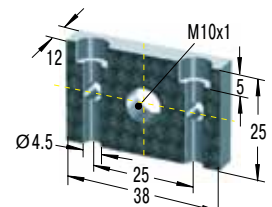

Universal Mount

BV10

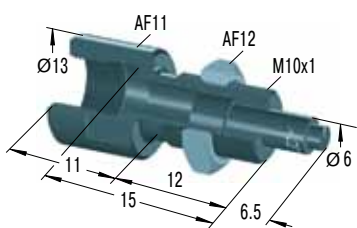

Side Load Adaptor

Dimensions BV10SC on request

PB10

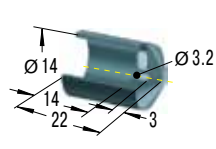

Steel Shroud

PB10SC

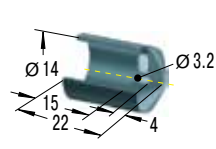

Steel Shroud

AS10

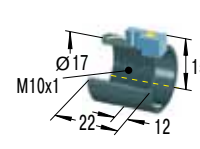

Switch Stop Collar
inc. Proximity Switch

PS10

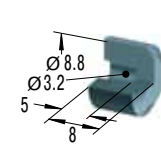

Steel Button

Mounting, installation... see pages 37 to 39.

M12x1

KM12



Locknut

AH12

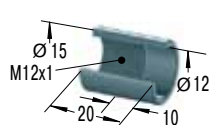

Stop Collar

MB12

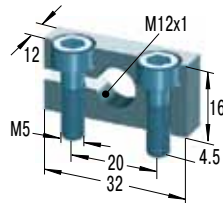

Clamp Mount

MB12SC2

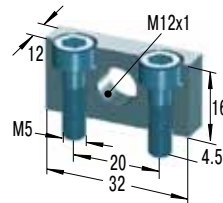

Mounting Block

RF12

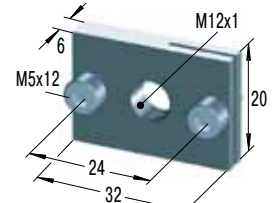

Rectangular Flange

UM12

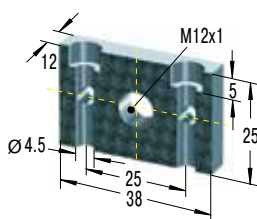

Universal Mount

BV12

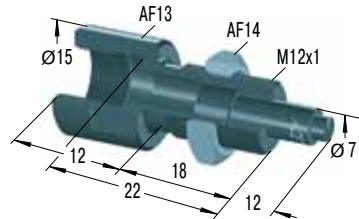

Side Load Adaptor

BV12SC

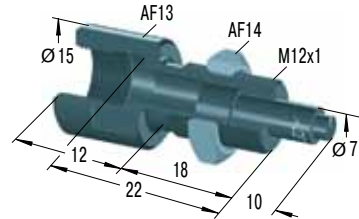

Side Load Adaptor

PB12

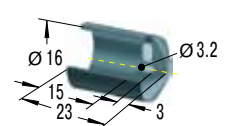

Steel Shroud

PB12SC

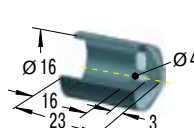

Steel Shroud

SP12

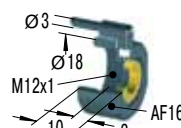

Air Bleed Collar

AS12

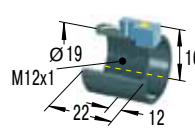

Switch Stop Collar
inc. Proximity Switch

PS12

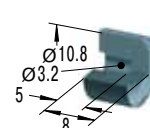

Steel Button

PS12SC

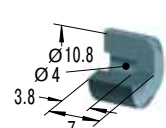

Steel Button

M14x1.5

KM14



Locknut

AH14

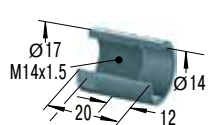

Stop Collar

MB14

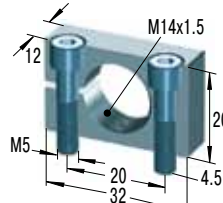

Clamp Mount

MB14SC2

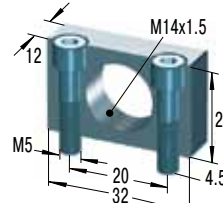

Mounting Block

RF14

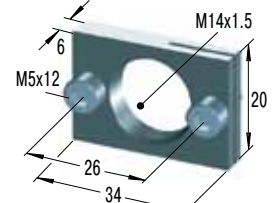

Rectangular Flange

UM14

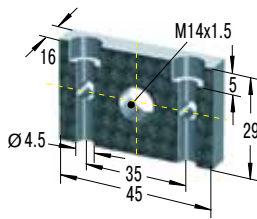

Universal Mount

BV14

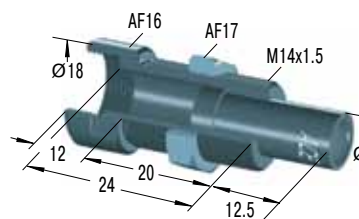

Side Load Adaptor

BV14SC

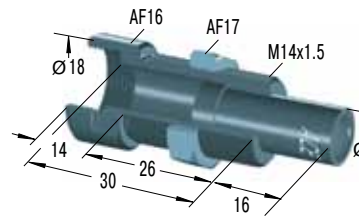

Side Load Adaptor

PB14

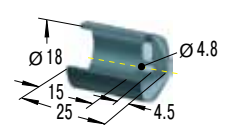

Steel Shroud

PB14SC

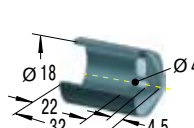

Steel Shroud

SP14

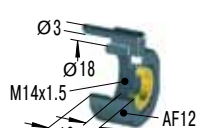

Air Bleed Collar

AS14

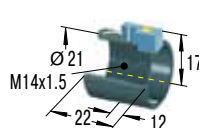

Switch Stop Collar
inc. Proximity Switch

PS14

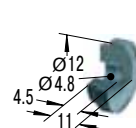

Steel Button

BP14

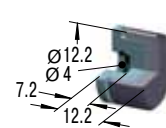

Steel/Urethane
Button

PP150

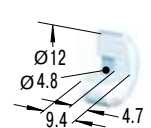

Nylon Button
W₃ max = 14 Nm

Mounting, installation... see pages 37 to 39.

Issue 7.2014. Specifications subject to change

M20x1.5

KM20



Locknut

AH20

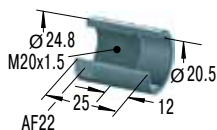

Stop Collar

MB20

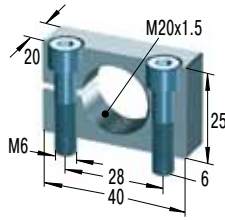

Clamp Mount

MB20SC2

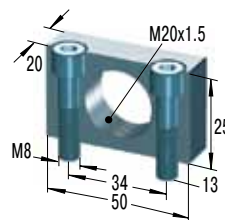

Mounting Block

RF20

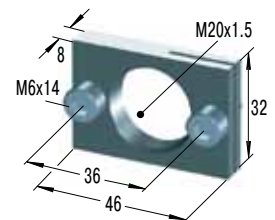

Rectangular Flange

UM20

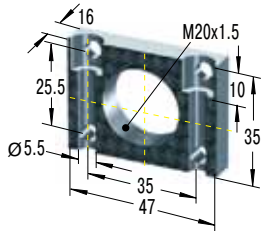

Universal Mount

BV20

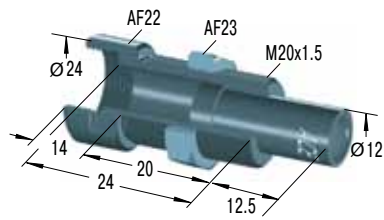

Side Load Adaptor

BV20SC

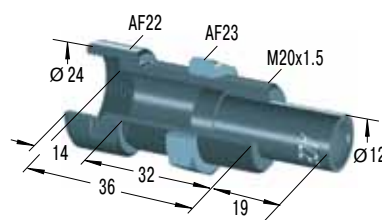

Side Load Adaptor

PB20

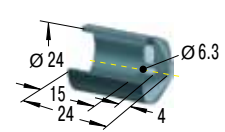

Steel Shroud

PB20SC

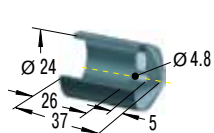

Steel Shroud

SP20

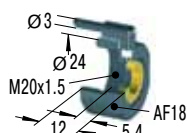

Air Bleed Collar

AS20

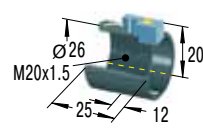

Switch Stop Collar
inc. Proximity Switch

PS20

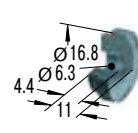

Steel Button

BP20

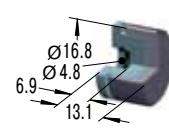

Steel/Urethane
Button

PP225

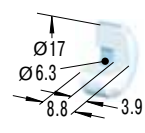

Nylon Button
W₃ max = 33 Nm

M25x1.5

KM25



Locknut

AH25

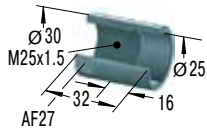

Stop Collar

MB25

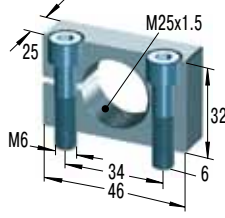

Clamp Mount

MB25SC2

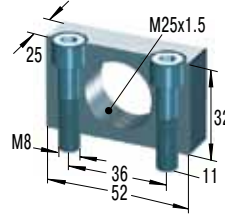

Mounting Block

RF25

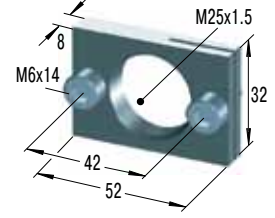

Rectangular Flange

UM25

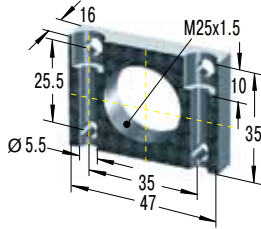

Universal Mount

BV25

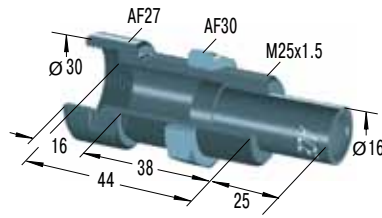

Side Load Adaptor

BV25SC

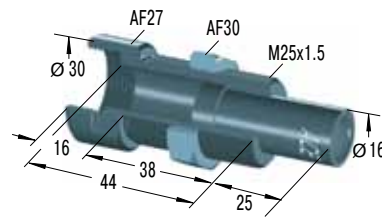

Side Load Adaptor

PB25

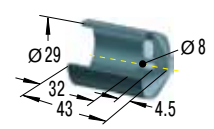

Steel Shroud

PB25SC

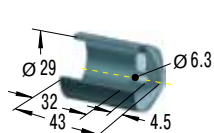

Steel Shroud

SP25

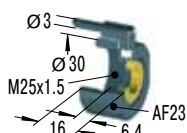

Air Bleed Collar

AS25

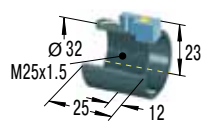

Switch Stop Collar
inc. Proximity Switch

PS25

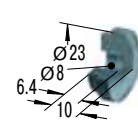

Steel Button

BP25

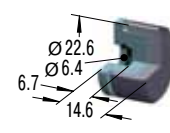

Steel/Urethane
Button

PP600

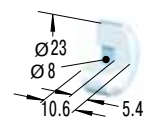

Nylon Button
W₃ max = 68 Nm

Mounting, installation... see pages 37 to 39.

AH Stop Collar

All ACE miniature shock absorbers (except FA series) have an **integral positive stop**. An **optional stop collar (AH...)** can be added if desired to give fine adjustment of final stopping position.

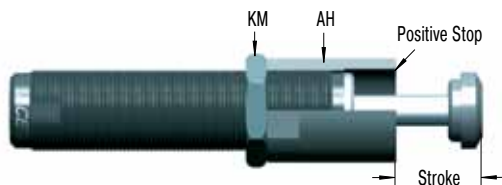

MB Clamp Mount/Mounting Block

When using the MB clamp mount no locknut is needed on the shock absorber (split clamp action). The mounting block is very compact and allows fine adjustment of the shock absorber position by turning in and out. Two socket head screws are included with clamp mount block. **When foot mounting the types with combined piston and inner tube SC²25M to SC²650M and the types MC5M, MC9M, MC30M, MC25M and MA30M, the MB (SC²) must be used.**



Clamp slot design not for use with SC²

Type	Screw Size	Max. Torque	Type	Screw Size	Max. Torque
MB10	M4x14	4 Nm	MB20	M6x25	11 Nm
MB12	M5x16	6 Nm	MB25	M6x30	11 Nm
MB14	M5x20	6 Nm			

RF Rectangular Flange

The rectangular flange RF provides a space saving convenient assembly and does not need a lock nut to hold the shock absorber. Therefore achieving a neat, compact and flat surface mounting.



Type	Screw Size	Max. Torque	Type	Screw Size	Max. Torque
RF6	M3x8	3 Nm	RF14	M5x12	6 Nm
RF8	M4x10	4 Nm	RF20	M6x14	11 Nm
RF10	M4x10	4 Nm	RF25	M6x14	11 Nm
RF12	M5x12	6 Nm			

PB Steel Shroud

Grinding beads, sand, welding splatter, paints and adhesives etc. can adhere to the piston rod. They then damage the rod seals and the shock absorber quickly fails. In many cases the installation of the optional steel shroud can provide worthwhile protection and increase lifetime.

Note! When installing don't forget to allow operating space for the shroud to move as the shock absorber is cycled. For part number MA, MC, SC please order with "M-880" suffix. Part numbers MA150M, MC150M to MC600M and SC25M to SC190M5-7 are supplied without a button, for advice on removing the button see page 38.

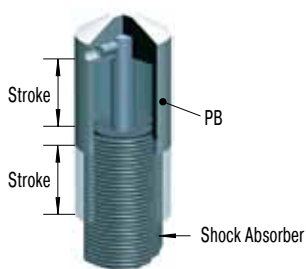

SP Air Bleed Collar

Air bleed collar (includes integral stop collar) protects shock absorber from ingress of abrasive contaminants like cement, paper or wood dust into the rod seal area. It also prevents aggressive fluids such as cutting oils, coolants etc. damaging the seals. Air bleed supply 0.5 to 1 bar. Low air consumption. The constant air bleed prevents contaminants passing the wiper ring and entering the shock absorber seal area.

Note! Do not switch off air supply whilst machine is operating! The air bleed collar cannot be used on all similar body thread sized shock absorbers. The air bleed collar is only for types MC150M to MC600M, MA150M, SC75M and SC190M5-7.

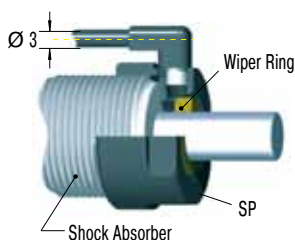

Issue 7.2014. Specifications subject to change

BV / BV...SC Side Load Adaptor

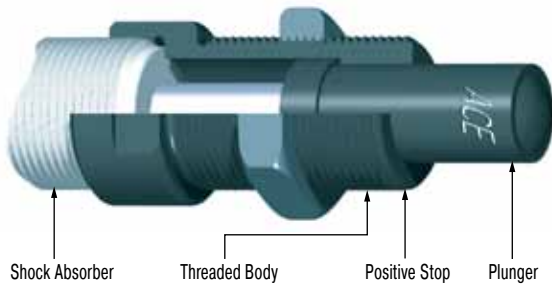

With side load impact angles of more than 3° the operation lifetime of the shock absorber reduces rapidly due to increased wear of the rod bearings. The optional BV side load adaptor provides long lasting solution. Secure the side load adaptor with Loctite or locknut on the shock absorber.

Material: Threaded body and plunger: Hardened high tensile steel. Hardened 610 HV1.

Note: For material combination plunger/impact plate use similar hardness values. We recommend that you install the shock absorber/side load adaptor using the thread on the side load adaptor.

Note! Installation with clamp mount MB... not possible. Use mounting block MB... SC².

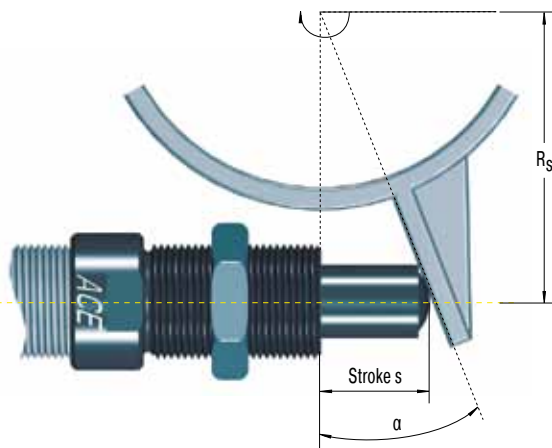

Problem: Rotating impact motion causes high side load forces on the piston rod. This increases bearing wear and possibly results in rod breakage or bending.

Solution: Install side load adaptor BV.

Formulae:

$$\alpha = \tan^{-1} \left(\frac{s}{R_s} \right) \quad R_{s \min} = \frac{s}{\tan \alpha \max}$$

Example:

s = 0.025 m

$\alpha \max = 25^\circ$ (Type BV25)

$R_s = 0.1 \text{ m}$

$$\alpha = \tan^{-1} \left(\frac{0.025}{0.1} \right) \quad R_{s \min} = \frac{0.025}{\tan 25}$$

$\alpha = 14.04^\circ \quad R_{s \min} = 0.054 \text{ m}$

α = side load angle ° R_s = mounting radius m
 $\alpha \max$ = max. angle ° $R_{s \min}$ = min. possible mounting radius m
s = absorber stroke m

Maximum angle:

BV8, BV10 and BV12 = 12.5°

BV14, BV20 and BV25 = 25°

Note: By repositioning the centre of the stroke of the side load plunger to be at 90 degrees to the piston rod, the side load angle can be halved. The use of an external positive stop due to high forces encountered is required.

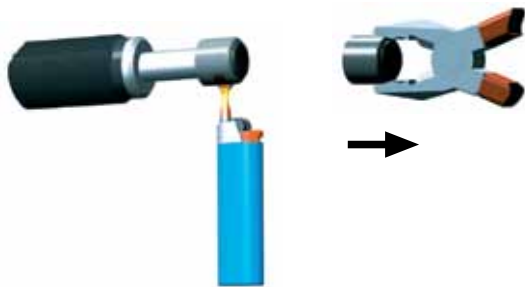

Time required for warming up the button:

up to M12x1: approx. 10 sec.

from M14x1.5 up: approx. 30 sec.

Note! The BV adaptor can only be installed onto a shock absorber without rod end button.

Part Number: MA, MC, SC...-880

(Models MC150M to MC600M and SC²25M to SC²190M5-7 are supplied as standard without buttons.)

To remove button from existing absorber: Clamp shock absorber in mounting block and warm button carefully. Grip the button with pliers and pull off along rod axis.

PP Nylon Button

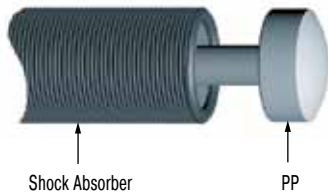

While the use of industrial shock absorbers already achieves a considerable reduction in noise levels, the additional use of PP impact buttons made of glass fibre reinforced nylon reduces noise levels even further, making it easy to fulfil the regulations of the new Noise Control Ordinance. At the same time, wear of impact surface is drastically minimized. The PP buttons are available for shock absorbers in series MC150M to MC600M. Model MA150M is supplied as standard with PP button. The buttons are fitted simply by pressing onto the piston rod.

BP Steel/Urethane Button

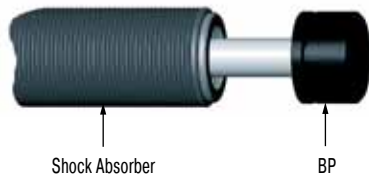

These new impact buttons made of urethane offer all above advantages of the PP nylon button in terms of reducing noise and wear. They fit easily onto the piston rod of the corresponding shock absorber. The head is then secured by a circlip integrated in the drilled hole of the steel base material. Please refer to the accessories table on pages 32 to 33 to see which shock absorber types the new BP buttons are available for.

PS / AS Steel Button, Switch Stop Collar

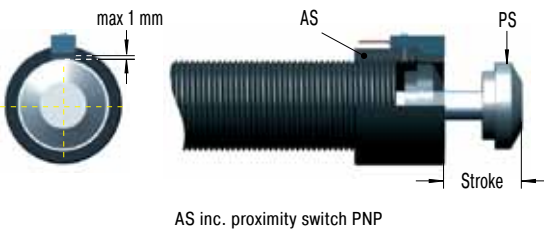

The ACE stop light switch stop collar combination can be mounted on all popular shock absorber models.

Features: Very short, compact mounting package.

The steel button type PS is fitted as standard on the models: SC190M0-4, SC300M0-9, SC650M0-9, SC925M0-4, MA/MVC225M, MA/MVC600M and MA/MVC900M. With all other models you must order the PS button as an optional accessory.

Mounting: We recommend to fix the steel button onto the end of the piston rod using Loctite 290. Attention! Take care not to leave any adhesive on the piston rod as this will cause seal damage. Thread the switch stop collar onto the front of the shock absorber and secure in position. Switch cable should not be routed close to power cables.

250-3 PNP Proximity Switch

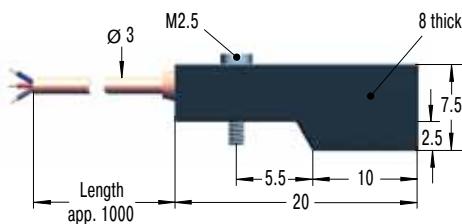

PNP proximity switch data:

- Supply voltage: 10-27 VDC
- Ripple: <10 %
- Load current max.: 100 mA
- Operating temperature range: -10 °C to +60 °C
- Residual voltage: max. 1 V
- Protection: IP67 (IEC 144) with LED-indicator
- Proximity switch N/Open when shock absorber extended.
- When shock absorber is fully compressed switch closes and LED indicator lights.

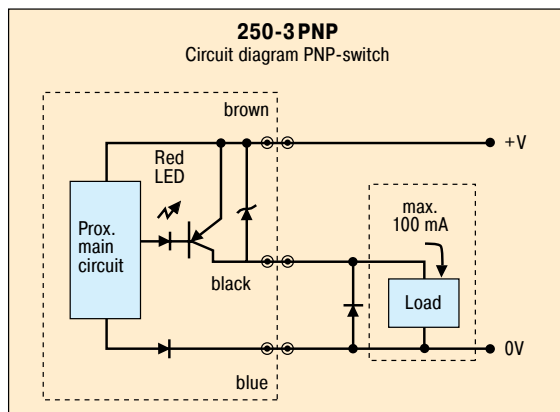

Issue 7.2014. Specifications subject to change

This range of self-compensating shock absorbers is part of the innovative **MAGNUM series** from ACE. You profit from the enhanced product life in the most difficult operating environments provided by the latest seal technology, hardened main bearing and also the integrated positive stop. You achieve **50% more energy absorption capacity** and a much wider range of effective weight capability (**between 3 kg and 63 700 kg!**). This offers you the capability of mounting shock absorbers with the highest energy capacity ratings for their size in the industry and allows full exploitation of your machinery potential. You can access new possibilities in machine design and construction since this range offers such features as a fully threaded outer body and a new clamping flange system.

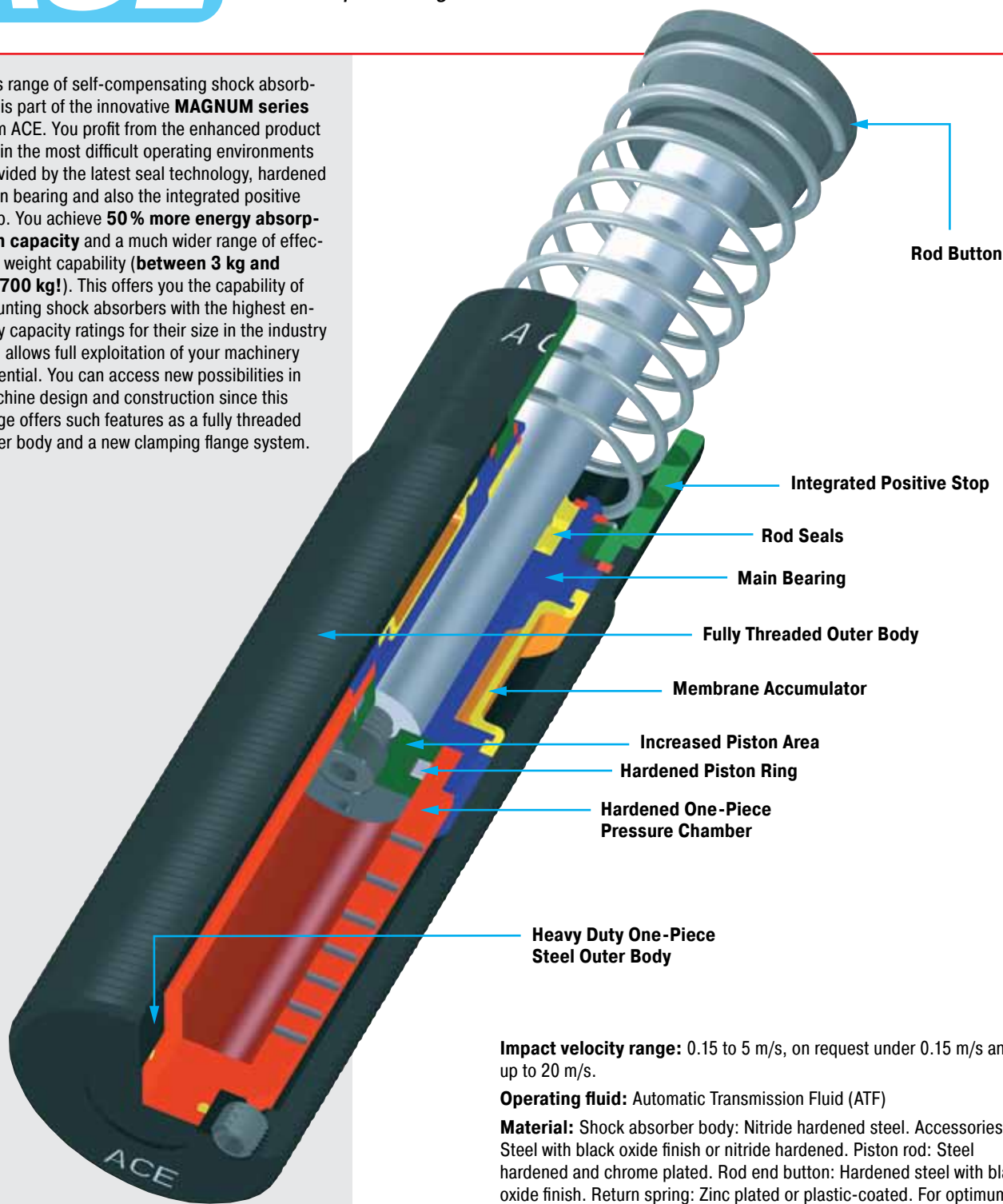

Impact velocity range: 0.15 to 5 m/s, on request under 0.15 m/s and up to 20 m/s.

Operating fluid: Automatic Transmission Fluid (ATF)

Material: Shock absorber body: Nitride hardened steel. Accessories: Steel with black oxide finish or nitride hardened. Piston rod: Steel hardened and chrome plated. Rod end button: Hardened steel with black oxide finish. Return spring: Zinc plated or plastic-coated. For optimum heat dissipation do not paint shock absorber.

Capacity rating: For emergency use only applications it is sometimes possible to exceed the published max. capacity ratings. Please consult ACE for further details. If your application exceeds the tabulated W_4 figures (max. energy per hour Nm/hr) consider additional cooling. Ask ACE for further details.

Mounting: In any position

Operating temperature range: -12 °C to 70 °C. Higher and lower temperatures see pages 50 to 51.

On request: Plated finishes. Wearthec finish (seawater resistant), special oils. Mounting inside air cylinders and other special options are available on request.

Noise reduction: 3 to 7 dB when using the impact buttons with urethane insert.



This adjustable shock absorber from ACE is unique. The innovative **MAGNUM series** models provide the next generation of deceleration technology to meet the needs of the future. The latest seal technology, a hardened main bearing and the integrated positive stop provide a significant increase in operating lifetime. Other innovations such as the front and rear adjuster, clamping flanges and the fully threaded outer body provide many new options in installation and mounting. Exploit the advantages of this series in your applications with its **50% increased energy capacity** and a much wider effective weight range. The effective weight range extends from 9 kg up to 80 000 kg. The **MA range** models cover the majority of standard applications, whilst the **ML range** is specially designed for low velocity/high effective weight applications from 300 kg up to 500 000 kg effective weight.

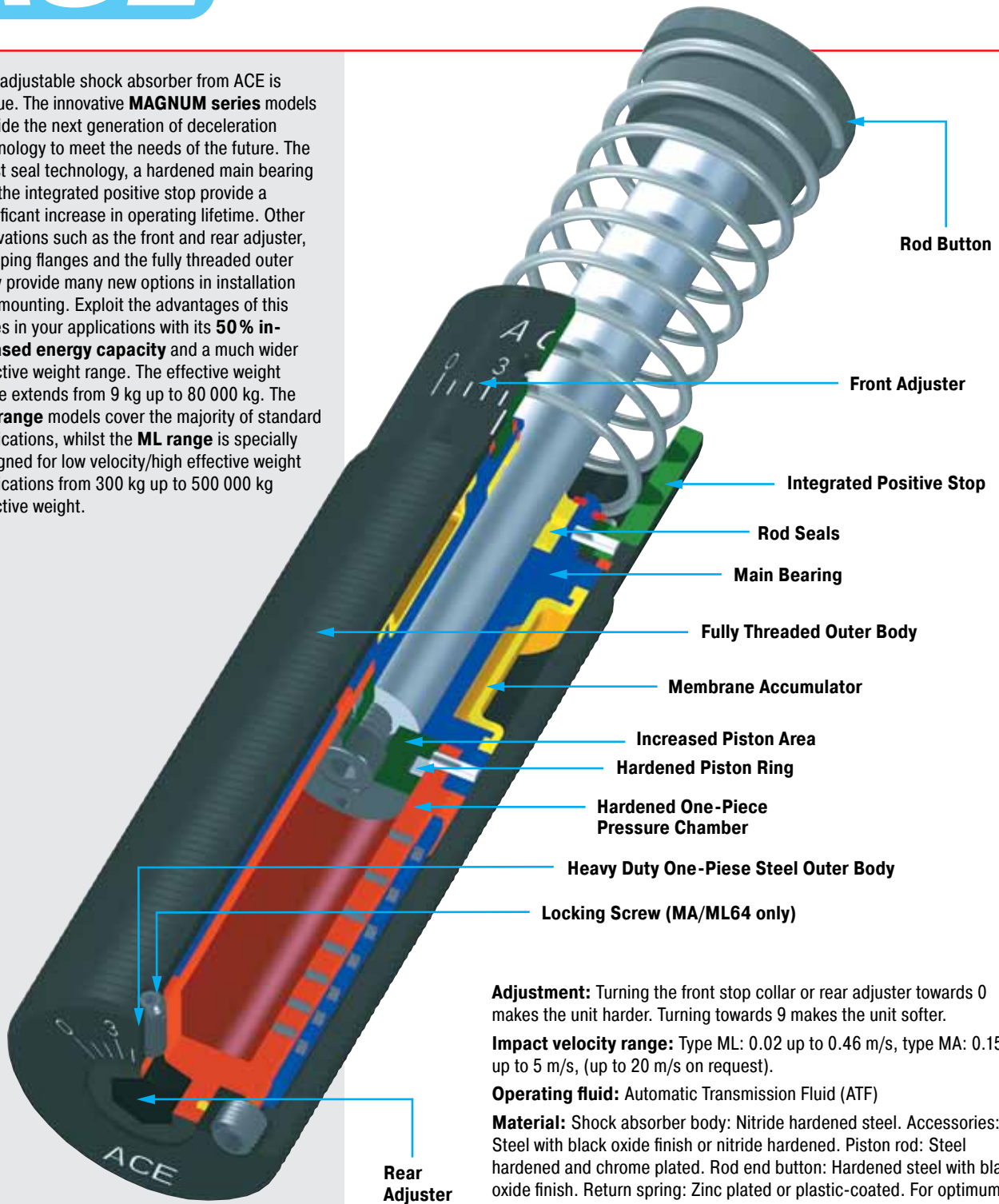

Adjustment: Turning the front stop collar or rear adjuster towards 0 makes the unit harder. Turning towards 9 makes the unit softer.

Impact velocity range: Type ML: 0.02 up to 0.46 m/s, type MA: 0.15 up to 5 m/s, (up to 20 m/s on request).

Operating fluid: Automatic Transmission Fluid (ATF)

Material: Shock absorber body: Nitride hardened steel. Accessories: Steel with black oxide finish or nitride hardened. Piston rod: Steel hardened and chrome plated. Rod end button: Hardened steel with black oxide finish. Return spring: Zinc plated or plastic-coated. For optimum heat dissipation do not paint shock absorber.

Capacity rating: For emergency use only applications it is sometimes possible to exceed the published max. capacity ratings. Please consult ACE for further details. If your application exceeds the tabulated W_4 figures (max. energy per hour Nm/hr) consider additional cooling. Ask ACE for further details.

Mounting: In any position

Operating temperature range: -12 °C to 70 °C. Higher and lower temperatures see pages 50 to 51.

On request: Plated finishes. Wearthec finish (seawater resistant), special oils. Mounting inside air cylinders and other special options are available on request.

Noise reduction: 3 to 7 dB when using the impact buttons with urethane insert.



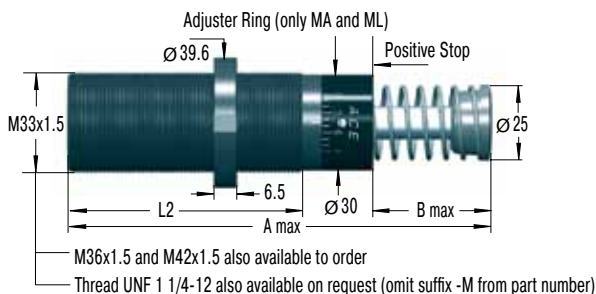

Adjuster (only MA and ML)

S33

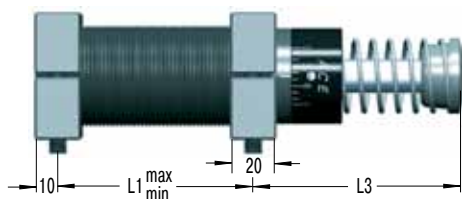

Side Foot Mounting Kit

S33 = 2 flanges + 4 screws M6x40, DIN 912

Because of the thread pitch the fixing holes for the second foot mount should only be drilled and tapped after the first foot mount has been fixed in position.

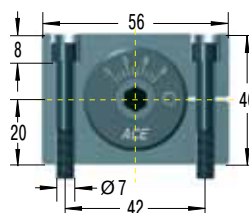

Tightening torque: 11 Nm
Clamping torque: > 90 Nm

C33



Clevis Mounting Kit

C33 = 2 clevis eyes. Delivered assembled to shock absorber. Use positive stop at both ends of travel.

SF33

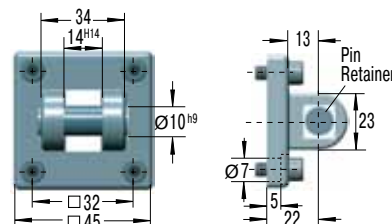

Clevis Flange

SF33 = flange + 4 screws M6x20, DIN 912

Tightening torque: 7.5 Nm

Clamping torque > 50 Nm

Secure with pin or use additional bar. Due to limited force capacity the respective ability should be reviewed by ACE.

Dimensions

Type	¹ Stroke mm	A max	B max	L1 min	L1 max	L2	L3	L5 max	L6 max
MC, MA, ML3325M	25	138	23	25	60	83	68	39	168
MC, MA, ML3350M	50	189	48.5	32	86	108	93	64	218

¹ Nominal stroke length (without integral stop collar fitted).

Capacity Chart MC33

Type	Max. Energy Capacity				¹ Effective Weight me					Min. Return Force N	Max. Return Force N	Rod Reset Time s	Max. Side Load Angle °	Weight kg					
	² W ₃ Nm/Cycle	W ₄ Self-Contained Nm/h	W ₄ with Air/Oil Tank Nm/h	W ₄ with Oil Recirculation Nm/h	Soft		Hard												
					min.	max.	-0	-1	-2						-3	-4			
MC3325M	155	75 000	124 000	169 000	3	11	9	40	30	120	100	420	350	1 420	45	90	0.03	4	0.45
MC3350M	310	85 000	135 000	180 000	5	22	18	70	60	250	210	840	710	2 830	45	135	0.06	3	0.54

Capacity Chart MA/ML33

Type	Max. Energy Capacity				¹ Effective Weight me		Min. Return Force N	Max. Return Force N	Rod Reset Time s	Max. Side Load Angle °	Weight kg
	² W ₃ Nm/Cycle	W ₄ Self-Contained Nm/h	W ₄ with Air/Oil Tank Nm/h	W ₄ with Oil Recirculation Nm/h	min.	max.					
MA3325M	170	75 000	124 000	169 000	9	- 1 700	45	90	0.03	4	0.45
ML3325M	170	75 000	124 000	169 000	300	- 50 000	45	90	0.03	4	0.45
MA3350M	340	85 000	135 000	180 000	13	- 2 500	45	135	0.06	3	0.54
ML3350M	340	85 000	135 000	180 000	500	- 80 000	45	135	0.06	3	0.66

¹ The effective weight range limits can be raised or lowered to special order.

² For emergency use only applications it is sometimes possible to exceed the above ratings. Please consult ACE for further details. Specifications relate to the effective stroke length (B max).

M33x1.5

NM33

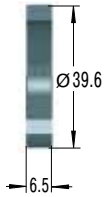

Locking Ring

PP33

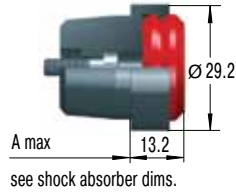

Poly Button

Optional button with elastomer insert for noise suppression. Option supplied ready mounted onto the shock absorber.

QF33

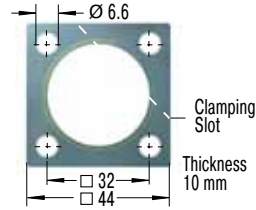

Square Flange

Install with 4 machine screws
Tightening torque: 11 Nm
Clamping torque: > 90 Nm

BV3325

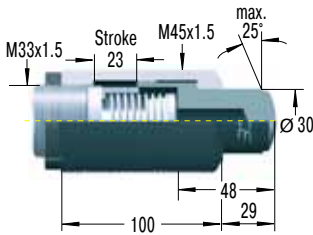

Side Load Adaptor

BV3350

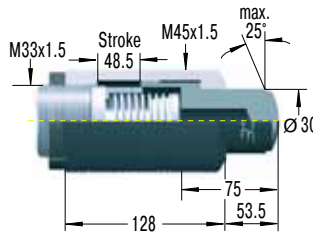

Side Load Adaptor

AS33

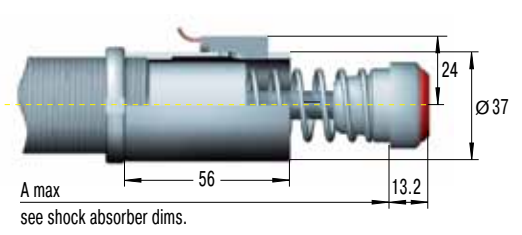

Switch Stop Collar

inc. Proximity Switch and Poly Button with elastomer insert

Mounting, installation etc. see pages 38 to 39 and 54.

PB3325

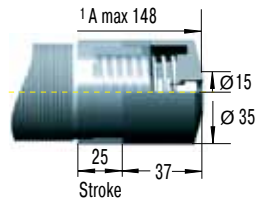

Steel Shroud

PB3350

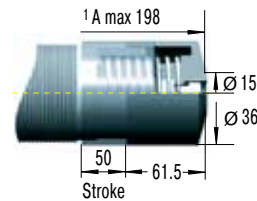

Steel Shroud

¹ Total installation length of the shock absorber inc. steel shroud

Mounting, installation etc. see page 54.

Ordering Example

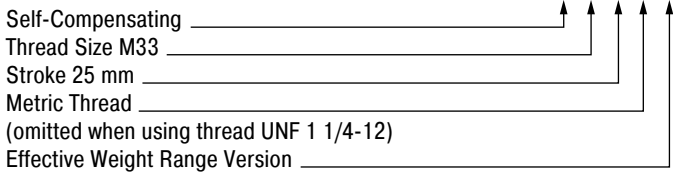

Model Type Prefix

Standard Models

Self-Contained with Return Spring

- MC Self-Compensating
- MA Adjustable
- ML Adjustable, for lower impact velocity

Special Models

Air/Oil Return without Return Spring

MCA, MAA, MLA

Air/Oil Return with Return Spring

MCS, MAS, MLS

Self-Contained without Return Spring

MCN, MAN, MLN

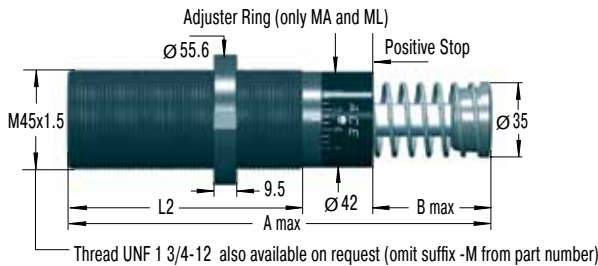

Adjuster (only MA and ML)

S45

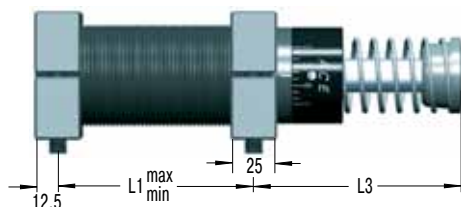

Side Foot Mounting Kit

S45 = 2 flanges + 4 screws M8x50, DIN 912

Because of the thread pitch the fixing holes for the second foot mount should only be drilled and tapped after the first foot mount has been fixed in position.

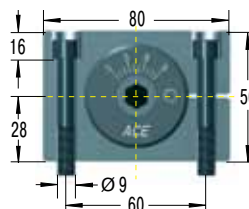

Tightening torque: 27 Nm
Clamping torque: > 350 Nm

C45

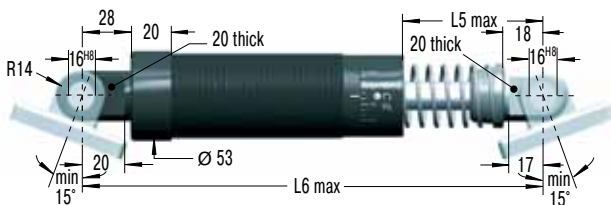

Clevis Mounting Kit

C45 = 2 clevis eyes. Delivered assembled to shock absorber. Use positive stop at both ends of travel.

SF45

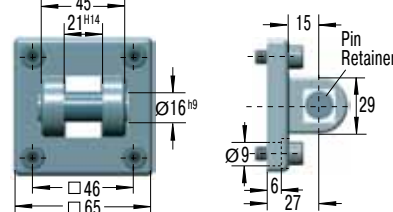

Clevis Flange

SF45 = flange + 4 screws M8x20, DIN 912

Tightening torque: 7.5 Nm
Clamping torque: > 140 Nm

Secure with pin or use additional bar. Due to limited force capacity the respective ability should be reviewed by ACE.

Dimensions

Type	¹ Stroke mm	A max	B max	L1 min	L1 max	L2	L3	L5 max	L6 max
MC, MA, ML4525M	25	145	23	32	66	95	66	43	200
MC, MA, ML4550M	50	195	48.5	40	92	120	91	68	250
MC, MA4575M	75	246	74	50	118	145	116	93	301

¹ Nominal stroke length (without integral stop collar fitted).

Capacity Chart MC45

Type	Max. Energy Capacity				¹ Effective Weight me					Min. Return Force N	Max. Return Force N	Rod Reset Time s	Max. Side Load Angle °	Weight kg
	² W ₃ Nm/Cycle	W ₄ Self-Contained Nm/h	W ₄ with Air/Oil Tank Nm/h	W ₄ with Oil Recirculation Nm/h	Soft		Hard							
					min. kg	max. kg	min. kg	max. kg	min. kg					
MC4525M	340	107 000	158 000	192 000	7 - 27	20 - 90	80 - 310	260 - 1 050	890 - 3 540	70	100	0.03	4	1.13
MC4550M	680	112 000	192 000	248 000	13 - 54	45 - 180	150 - 620	520 - 2 090	1 800 - 7 100	70	145	0.08	3	1.36
MC4575M	1020	146 000	22 5000	282 000	20 - 80	70 - 270	230 - 930	790 - 3 140	2 650 - 10 600	50	180	0.11	2	1.59

Capacity Chart MA/ML45

Type	Max. Energy Capacity				¹ Effective Weight me		Min. Return Force N	Max. Return Force N	Rod Reset Time s	Max. Side Load Angle °	Weight kg
	² W ₃ Nm/Cycle	W ₄ Self-Contained Nm/h	W ₄ with Air/Oil Tank Nm/h	W ₄ with Oil Recirculation Nm/h	min. kg	max. kg					
MA4525M	390	107 000	158 000	192 000	40	- 10 000	70	100	0.03	4	1.14
ML4525M	390	107 000	158 000	192 000	3 000	- 110 000	70	100	0.03	4	1.13
MA4550M	780	112 000	192 000	248 000	70	- 14 500	70	145	0.08	3	1.36
ML4550M	780	112 000	192 000	248 000	5 000	- 180 000	70	145	0.08	3	1.36
MA4575M	1 170	146 000	225 000	282 000	70	- 15 000	50	180	0.11	2	1.59

¹ The effective weight range limits can be raised or lowered to special order.

² For emergency use only applications it is sometimes possible to exceed the above ratings. Please consult ACE for further details. Specifications relate to the effective stroke length (B max).

M45x1.5

NM45

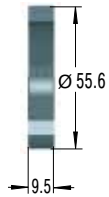

Locking Ring

PP45

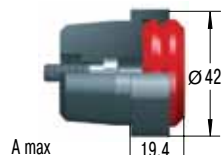

A max
see shock absorber dims.

Poly Button

Optional button with elastomer insert for noise suppression. Option supplied ready mounted onto the shock absorber.

QF45

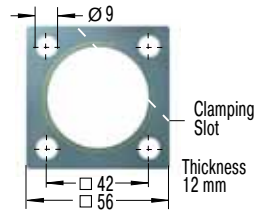

Square Flange

Install with 4 machine screws
Tightening torque: 27 Nm
Clamping torque: > 200 Nm

BV4525

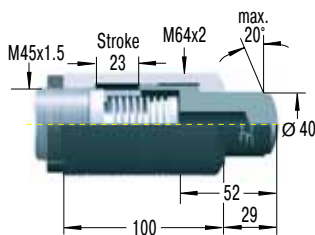

Side Load Adaptor

BV4550

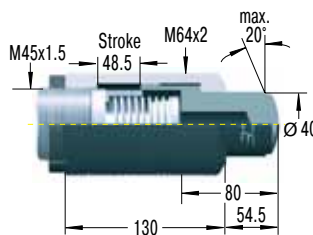

Side Load Adaptor

AS45

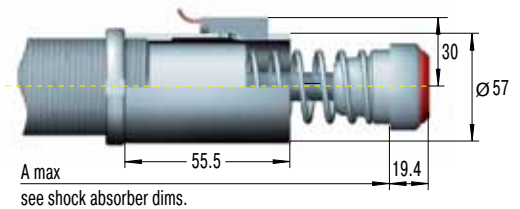

A max
see shock absorber dims.

Switch Stop Collar

inc. Proximity Switch and Poly Button with elastomer insert

Mounting, installation etc. see pages 38 to 39 and 54.

PB4525

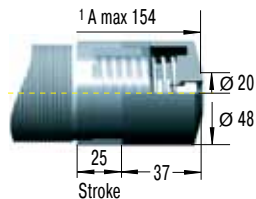

Steel Shroud

PB4550

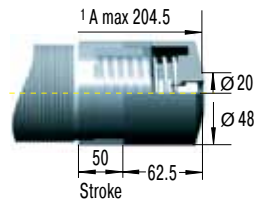

Steel Shroud

¹ Total installation length of the shock absorber inc. steel shroud

Mounting, installation etc. see page 54.

Ordering Example

Adjustable _____
Thread Size M45 _____
Stroke 25 mm _____
Metric Thread _____
(omitted when using thread UNF 1 3/4-12)

ML4525M

Model Type Prefix

Standard Models

Self-Contained with Return Spring

MC Self-Compensating
MA Adjustable
ML Adjustable, for lower impact velocity

Special Models

Air/Oil Return without Return Spring

MCA, MAA, MLA

Air/Oil Return with Return Spring

MCS, MAS, MLS

Self-Contained without Return Spring

MCN, MAN, MLN

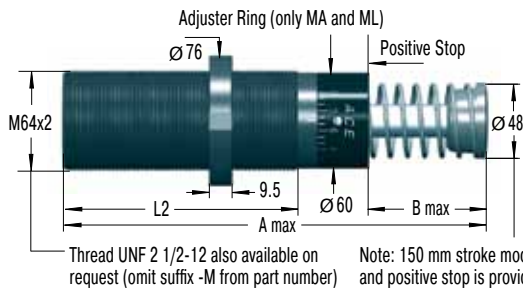

Adjuster (only MA and ML)

S64

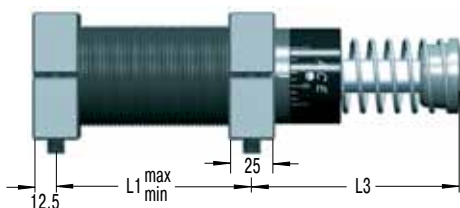

Side Foot Mounting Kit

S64 = 2 flanges + 4 screws M10x80, DIN 912

Because of the thread pitch the fixing holes for the second foot mount should only be drilled and tapped after the first foot mount has been fixed in position.

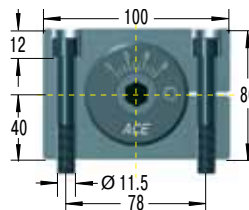

Tightening torque: 50 Nm
Clamping torque: > 350 Nm

C64



Clevis Mounting Kit

C64 = 2 clevis eyes. Delivered assembled to shock absorber.

¹ with 150 mm stroke Dia. 60 mm. Order C64-150.

Use positive stop at both ends of travel.

SF64

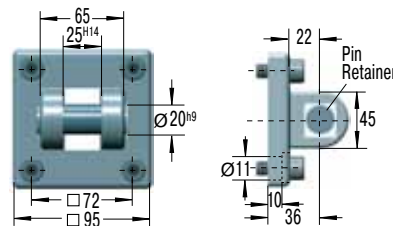

Clevis Flange

SF64 = flange + 4 screws M10x20, DIN 912

Tightening torque: 15 Nm

Clamping torque: > 200 Nm

Secure with pin or use additional bar. Due to limited force capacity the respective ability should be reviewed by ACE.

Dimensions

Type	¹ Stroke mm	A max	B max	L1 min	L1 max	L2	L3	L5 max	L6 max
ML6425M	25	174	23	40	86	114	75.5	60	260
MC, MA, ML6450M	50	225	48.5	50	112	140	100	85	310
MC, MA64100M	100	326	99.5	64	162	191	152	136	410
MC, MA64150M	150	450	150	80	212	241	226	187	530

¹ Nominal stroke length (without integral stop collar fitted).

Capacity Chart MC64

Type Self-Compensating	Max. Energy Capacity				¹ Effective Weight me					Min. Return Force N	Max. Return Force N	Rod Reset Time s	Max. Side Load Angle °	Weight kg
	² W ₃ Nm/Cycle	W ₄ Self-Contained Nm/h	W ₄ with Air/Oil Tank Nm/h	W ₄ with Oil Recirculation Nm/h	Soft			Hard						
					-0 min. max. kg	-1 min. max. kg	-2 min. max. kg	-3 min. max. kg	-4 min. max. kg					
MC6450M	1 700	146 000	293 000	384 000	35 - 140	140 - 540	460 - 1 850	1 600 - 6 300	5 300 - 21 200	90	155	0.12	4	2.9
MC64100M	3 400	192 000	384 000	497 000	70 - 280	270 - 1 100	930 - 3 700	3 150 - 12 600	10 600 - 42 500	105	270	0.34	3	3.7
MC64150M	5 100	248 000	497 000	644 000	100 - 460	410 - 1 640	1 390 - 5 600	4 700 - 18 800	16 000 - 63 700	75	365	0.48	2	5.1

Capacity Chart MA/ML64

Type Adjustable	Max. Energy Capacity				¹ Effective Weight me		Min. Return Force N	Max. Return Force N	Rod Reset Time s	Max. Side Load Angle °	Weight kg
	² W ₃ Nm/Cycle	W ₄ Self-Contained Nm/h	W ₄ with Air/Oil Tank Nm/h	W ₄ with Oil Recirculation Nm/h	min.	max.					
					kg						
ML6425M	1 020	124 000	248 000	332 000	7 000	- 300 000	120	155	0.06	5	2.5
MA6450M	2 040	146 000	293 000	384 000	220	- 50 000	90	155	0.12	4	2.9
ML6450M	2 040	146 000	293 000	384 000	11 000	- 500 000	90	155	0.12	4	2.9
MA64100M	4 080	192 000	384 000	497 000	270	- 52 000	105	270	0.34	3	3.7
MA64150M	6 120	248 000	497 000	644 000	330	- 80 000	75	365	0.48	2	5.1

¹ The effective weight range limits can be raised or lowered to special order.

² For emergency use only applications it is sometimes possible to exceed the above ratings. Please consult ACE for further details. Specifications relate to the effective stroke length (B max).

M64x2

NM64

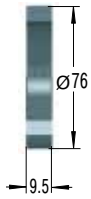

Locking Ring

PP64

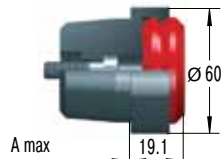

see shock absorber dims.

Poly Button

Optional button with elastomer insert for noise suppression. Option supplied ready mounted onto the shock absorber.

QF64

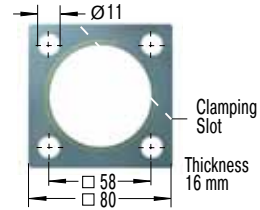

Square Flange

Install with 4 machine screws
Tightening torque: 50 Nm
Clamping torque: > 210 Nm

BV6425

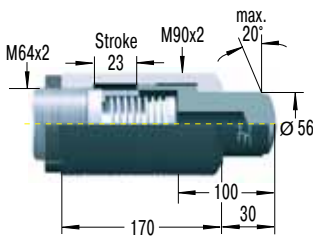

Side Load Adaptor

BV6450

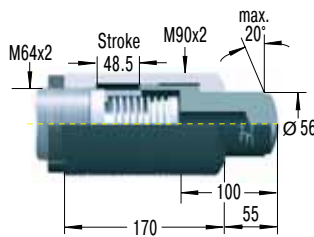

Side Load Adaptor

QF90

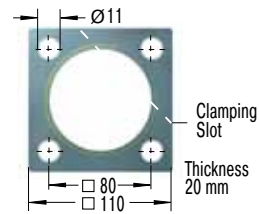

Square Flange

Install with 4 machine screws
Tightening torque: 50 Nm
Clamping torque: > 210 Nm

Mounting, installation etc. see pages 38 and 54.

PB6425

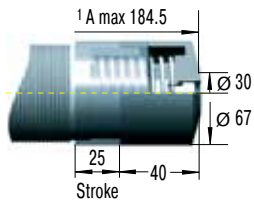

Steel Shroud

PB6450

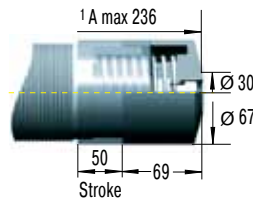

Steel Shroud

¹ Total installation length of the shock absorber inc. steel shroud

Mounting, installation etc. see page 54.

Ordering Example

Adjustable _____
Thread Size M64 _____
Stroke 50 mm _____
Metric Thread _____
(omitted when using thread UNF 2 1/2-12)

MA6450M

Model Type Prefix

Standard Models

Self-Contained with Return Spring

MC Self-Compensating
MA Adjustable
ML Adjustable, for lower impact velocity

Special Models

Air/Oil Return without Return Spring

MCA, MAA, MLA

Air/Oil Return with Return Spring

MCS, MAS, MLS

Self-Contained without Return Spring

MCN, MAN, MLN

Based on the successful damping technology of our MAGNUM-Series, ACE offers this self-adjusting industrial shock absorber in complete **stainless steel design**. All outer parts, such as outer body, stop collar, and main bearing are manufactured of **V4A (material spec. number 1.4404)**. The MAGNUM VA series is therefore ideally suited for applications within the fields of medical technology, the food industry, electronics and the marine and associated industries. The **MAGNUM VA series** offers all the proven advantages of the MAGNUM standard series, like its robust and most modern seal technology, the highest energy absorption in a compact design, an integrated mechanical stop, and a wide range of effective weights. This series is available in thread sizes M33x1.5 to M64x2 with stroke lengths of up to 100 mm. The MAGNUM VA series also offers a rod button made of V4A with a polyurethane element to reduce noise levels. Additionally all MAGNUM VA dampers are filled with a special oil that conforms to the approval requirements (NSF-H1) of the food industry ex stock.

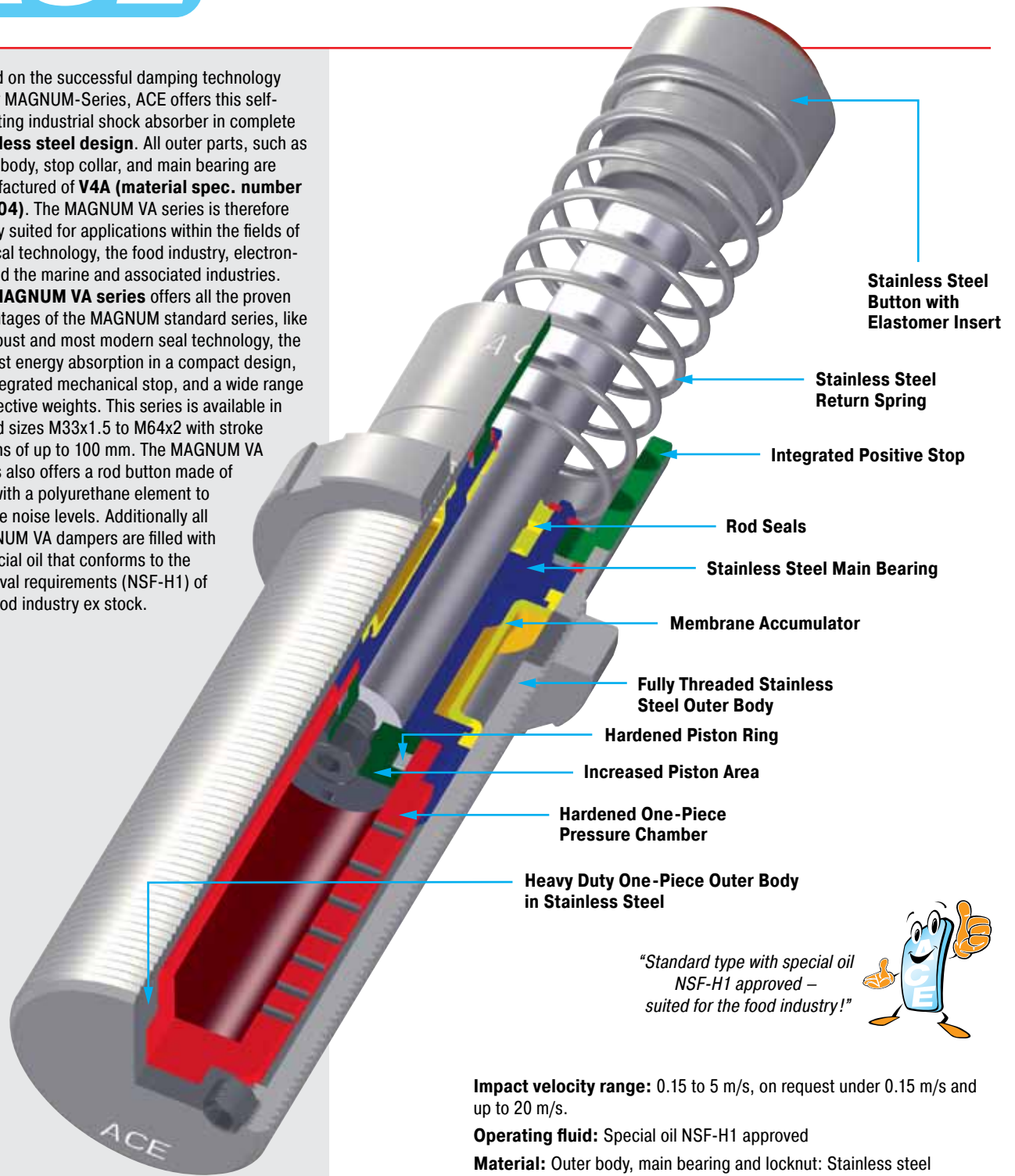

"Standard type with special oil NSF-H1 approved – suited for the food industry!"



Impact velocity range: 0.15 to 5 m/s, on request under 0.15 m/s and up to 20 m/s.

Operating fluid: Special oil NSF-H1 approved

Material: Outer body, main bearing and locknut: Stainless steel (1.4404/AISI 316L). Accessories: Stainless steel (1.4404/AISI 316L). Piston rod: hardened and chrome plated steel. Button: Stainless steel (1.4404/AISI 316L) with elastomer insert. Return spring: Stainless steel.

Capacity rating: For emergency only applications it is sometimes possible to exceed the published max. capacity ratings. Please consult ACE for further details. If your application exceeds the tabulated W_4 figures (max. energy per hour Nm/hr) consider additional cooling. Ask ACE for further details.

Mounting: In any position

Operating temperature range: -12 °C to 70 °C. For higher and lower temperatures consult ACE.

On request: Special oils, HT/LT models and special accessories.

Noise reduction: 3 to 7 dB when using the impact buttons with urethane insert.



MC33xxM-V4A

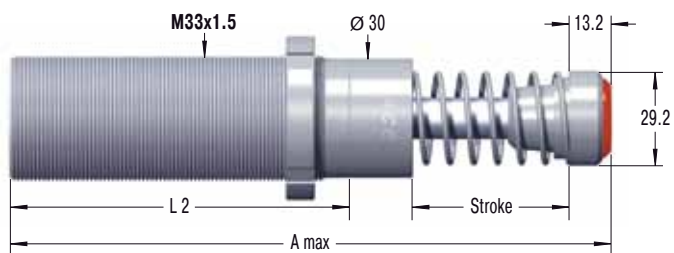

NM33-V4A

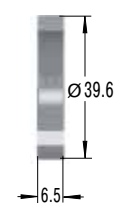

Locking Ring

QF33-V4A

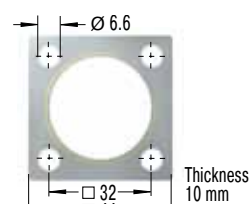

Square Flange

MC45xxM-V4A

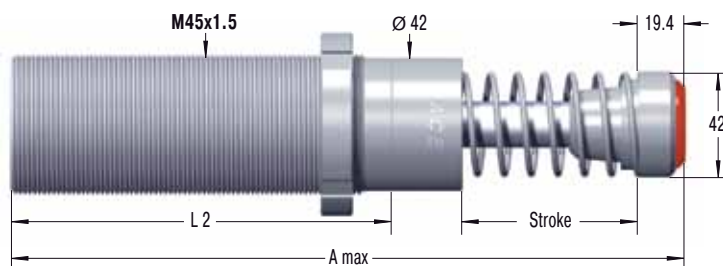

NM45-V4A

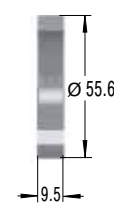

Locking Ring

QF45-V4A

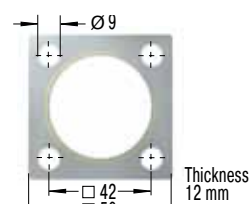

Square Flange

MC64xxM-V4A



NM64-V4A

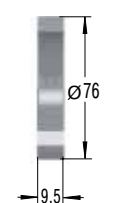

Locking Ring

QF64-V4A

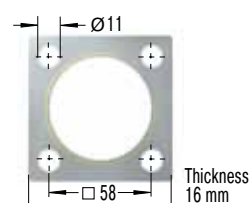

Square Flange

Dimensions

Type	Stroke mm	A max	L2
MC3325M-V4A	23	151.2	83
MC3350M-V4A	48.5	202.2	108
MC4525M-V4A	23	164.5	95
MC4550M-V4A	48.5	214.4	120
MC4575M-V4A	74	265.4	145
MC6450M-V4A	48.5	244.1	140
MC64100M-V4A	99.5	345.1	191

Ordering Example

Self-Compensating MC4550M-1-V4A
 Thread Size M45
 Stroke 50 mm
 Metric Thread
 Effective Weight Range Version
 Stainless Steel 1.4404/AISI 316L

Capacity Chart MC33/MC45/MC64

Type	Max. Energy Capacity		1 Effective Weight me					Min. Return Force N	Max. Return Force N	Rod Reset Time s	Max. Side Load Angle °	Weight kg
	2 W ₃ Nm/Cycle	W ₄ Nm/h	Soft			Hard						
			-0 min. max. kg	-1 min. max. kg	-2 min. max. kg	-3 min. max. kg	-4 min. max. kg					
MC3325M-V4A	155	75 000	3 - 11	9 - 40	30 - 120	100 - 420	350 - 1 420	45	90	0.03	4	0.45
MC3350M-V4A	310	85 000	5 - 22	18 - 70	60 - 250	240 - 840	710 - 2 830	45	135	0.06	3	0.54
MC4525M-V4A	340	107 000	7 - 27	20 - 90	80 - 310	260 - 1 050	890 - 3 540	70	100	0.03	4	1.13
MC4550M-V4A	680	112 000	13 - 54	45 - 180	150 - 620	520 - 2 090	1 800 - 7 100	70	145	0.08	3	1.36
MC4575M-V4A	1 020	146 000	20 - 80	70 - 270	230 - 930	790 - 3 140	2 650 - 10 600	50	180	0.11	2	1.59
MC6450M-V4A	1 700	146 000	35 - 140	140 - 540	460 - 1 850	1 600 - 6 300	5 300 - 21 200	90	155	0.12	4	2.9
MC64100M-V4A	3 400	192 000	70 - 280	270 - 1 100	930 - 3 700	3 150 - 12 600	10 600 - 42 500	105	270	0.34	3	3.7

¹ The effective weight range limits can be raised or lowered to special order.

² For emergency only applications it is sometimes possible to exceed the above ratings. Please consult ACE for further details.

ACE's High and Low-Temperature **MAGNUM Series** offers industrial shock absorbers that ensure, even at **extreme temperatures of -50 °C to +150 °C**, safe and reliable shock absorption combined with 100% energy reduction. The new MAGNUM-LT series is available in all sizes corresponding with the MAGNUM-Standard series. The tried and tested MAGNUM-HT series is therefore supplemented with a low temperature variant.

"Consistent deceleration at extreme temperatures by means of special seals and operating fluids!"



NEW

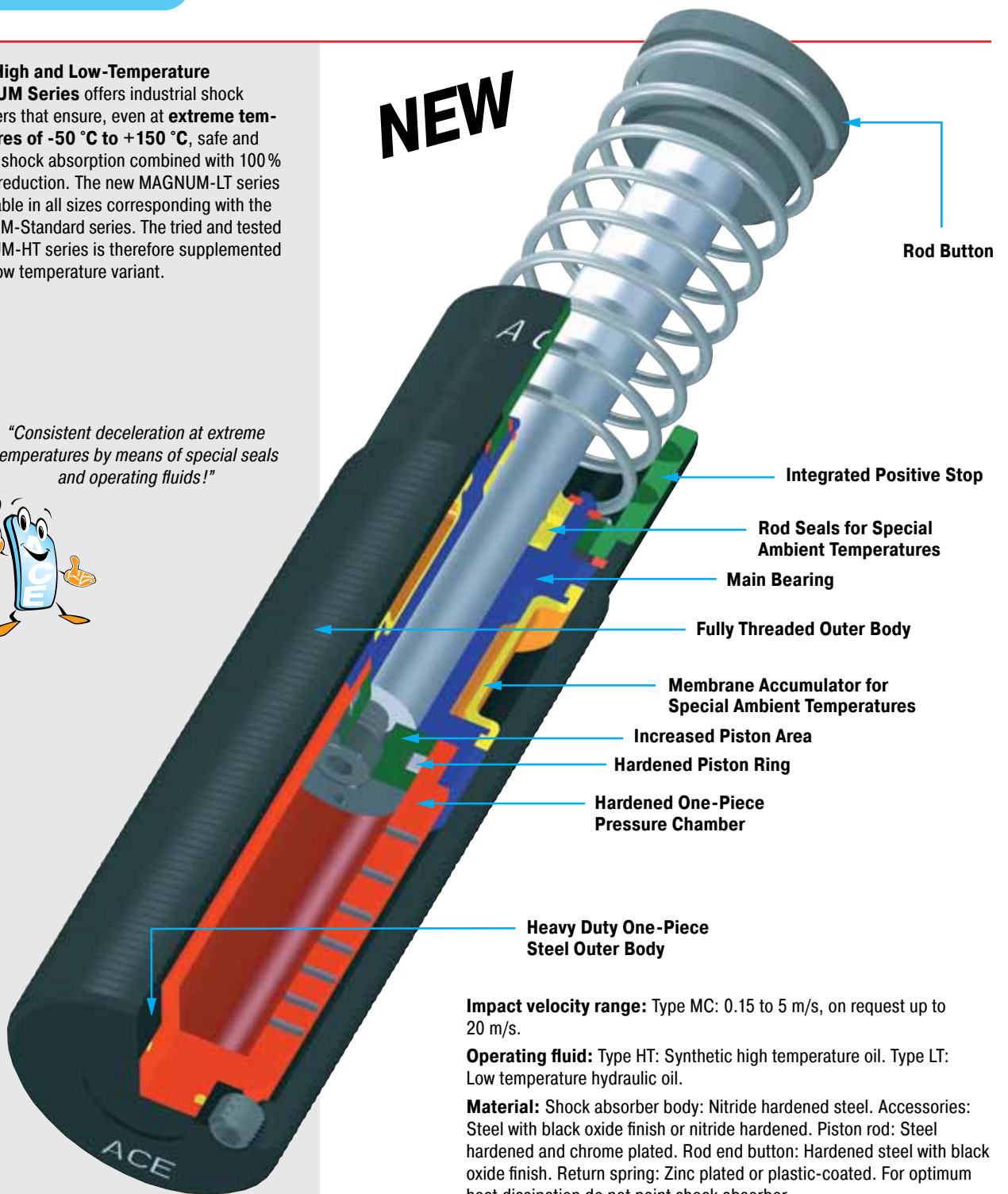

Rod Button

Integrated Positive Stop

Rod Seals for Special Ambient Temperatures

Main Bearing

Fully Threaded Outer Body

Membrane Accumulator for Special Ambient Temperatures

Increased Piston Area

Hardened Piston Ring

Hardened One-Piece Pressure Chamber

Heavy Duty One-Piece Steel Outer Body

Impact velocity range: Type MC: 0.15 to 5 m/s, on request up to 20 m/s.

Operating fluid: Type HT: Synthetic high temperature oil. Type LT: Low temperature hydraulic oil.

Material: Shock absorber body: Nitride hardened steel. Accessories: Steel with black oxide finish or nitride hardened. Piston rod: Steel hardened and chrome plated. Rod end button: Hardened steel with black oxide finish. Return spring: Zinc plated or plastic-coated. For optimum heat dissipation do not paint shock absorber.

Capacity rating: For emergency use only applications it is sometimes possible to exceed the published max. capacity ratings. Please consult ACE for further details. If your application exceeds the tabulated W_4 figures (max. energy per hour Nm/hr) consider additional cooling. Ask ACE for further details.

Mounting: In any position

Operating temperature range: Type LT: -50 °C to 66 °C, type HT: 0 °C to 150 °C.

On request: Plated finishes, weartec finish (seawater resistant). Mounting inside air cylinders and other special options are available on request.

Noise reduction: 3 to 7 dB when using the impact buttons with urethane insert.



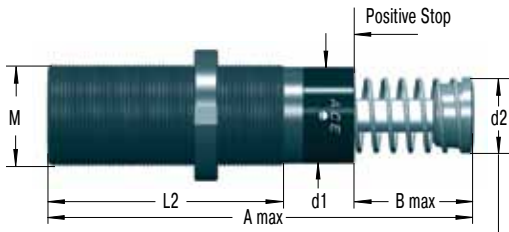

Note: 150 mm stroke model does not include stop collar and positive stop is provided by the rod button (Ø 60 mm)

Ordering Example

Self-Compensating _____
 Thread Size M33 _____
 Stroke 50 mm _____
 Metric Thread (omitted when using thread UNF) _____
 Effective Weight Range Code _____
 HT = Version for High Temperature Use _____
 LT = Version for Low Temperature Use _____

MC3350M-2-HT

Complete Details Required when Ordering

Load to be decelerated m (kg)
 Impact velocity v (m/s)
 Propelling force F (N)
 Operating cycles per hour c (/hr)
 Number of absorbers in parallel n
 Ambient temperature °C

The calculation and selection of the most suitable shock absorber (effective weight range) should be carried out or be approved by ACE.

Dimensions and Capacity Chart MC33-HT to MC64-HT

Type	1 Stroke mm	A max	B	d1	d2	L2	M	Max. Energy Capacity			Max. Side Load Angle °	Weight kg
								per Cycle W ₃ Nm/Cycle	per Hour W ₄ at 20 °C Nm/h	W ₄ at 100 °C Nm/h		
MC3325M-HT	25	138	23	30	25	83	M33x1.5	155	215 000	82 000	4	0.45
MC3350M-HT	50	189	48.5	30	25	108	M33x1.5	310	244 000	93 000	3	0.54
MC4525M-HT	25	145	23	42	35	95	M45x1.5	340	307 000	117 000	4	1.13
MC4550M-HT	50	195	48.5	42	35	120	M45x1.5	680	321 000	122 000	3	1.36
MC6450M-HT	50	225	48.5	60	48	140	M64x2	1 700	419 000	159 000	4	2.9
MC64100M-HT	100	326	99.5	60	48	191	M64x2	3 400	550 000	200 000	3	3.7

Adjustable models are also available on request.

¹ Nominal stroke length (without stop collar fitted).

Dimensions and Capacity Chart MC33-LT to MC64-LT

Type	1 Stroke mm	A max	B	d1	d2	L2	M	Max. Energy Capacity			2 Rod Reset Time s	Max. Side Load Angle °	Weight kg
								per Cycle W ₃ Nm/Cycle	per Hour W ₄ Nm/h				
MC3325M-LT	25	138	23	30	25	83	M33x1.5	155	75 000	0.08	4	0.5	
MC3350M-LT	50	189	48.5	30	25	108	M33x1.5	310	85 000	0.16	3	0.54	
MC4525M-LT	25	145	23	42	35	95	M45x1.5	340	107 000	0.08	4	1.13	
MC4550M-LT	50	195	48.5	42	35	120	M45x1.5	680	112 000	0.16	3	1.36	
MC4575M-LT	75	246	74	42	35	145	M45x1.5	1 020	146 000	0.24	2	1.59	
MC6450M-LT	50	225	48.5	60	48	140	M64x2	1 700	146 000	0.24	4	2.9	
MC64100M-LT	100	326	99.5	60	48	191	M64x2	3 400	192 000	0.68	3	3.7	
MC64150M-LT	150	450	150	60	48	241	M64x2	5 100	248 000	0.96	2	5.1	

Adjustable models are also available on request.

¹ Nominal stroke length (without stop collar fitted).

² at -50 °C

The newly developed industrial shock absorbers **SC4525M** and **SC4550M** are predestined for safe and reliable braking performance, especially for rotary movements without undesirable recoil effects. The piston tube technology known from the SC² series was therefore successfully transferred to the SC45 series. The shock absorber elements offer the highest braking power because of a significant increase of oil volume. Mounting the piston tube near the centre of rotation and the resulting low impact speed present no problem. Short stroke lengths of 25 to 50 mm together with a high level of energy absorption ensure minimum braking times. The MAGNUM series' tried and tested seal technology, together with membrane accumulators, ensures the long service life of dampers. Designs with specialised seals are available for direct installation in the pressure chamber, such as in rotary modules.

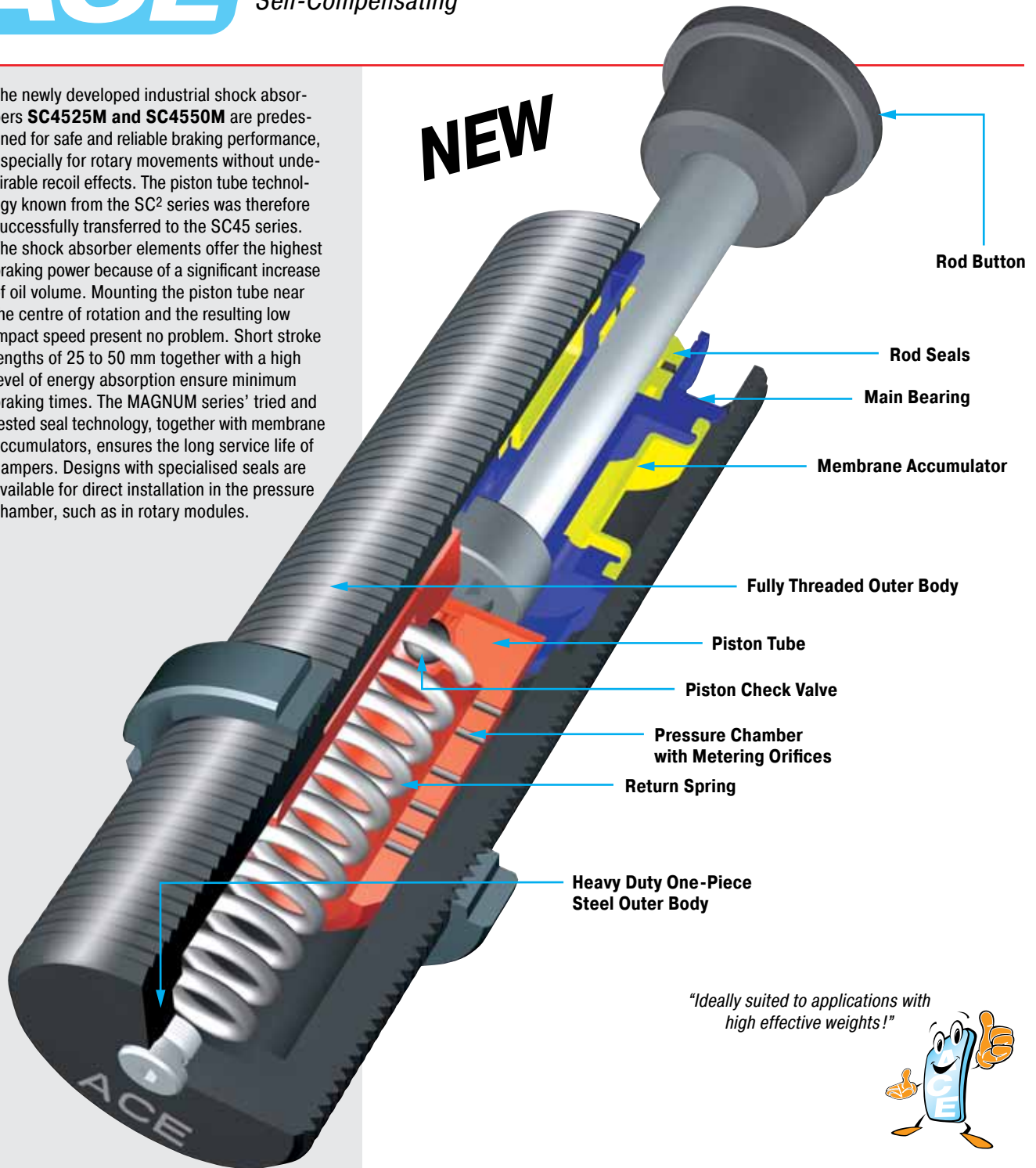

"Ideally suited to applications with high effective weights!"



Positive stop: An integrated positive stop is fitted as standard (see page 53).

Impact velocity range: Ensure that effective weight of application is within the range of the unit chosen.

Operating fluid: Automatic Transmission Fluid (ATF)

Material: Shock absorber body: Nitride hardened steel. Accessories: Steel with black oxide finish or nitride hardened. Piston rod: Steel hardened and chrome plated. Rod end button: Hardened steel with black oxide finish. For optimum heat dissipation do not paint shock absorber.

Mounting: In any position

Operating temperature range: -12 °C to 70 °C. For other temperatures consult ACE.

On request: Special oils, mounting inside air cylinders and other special options.



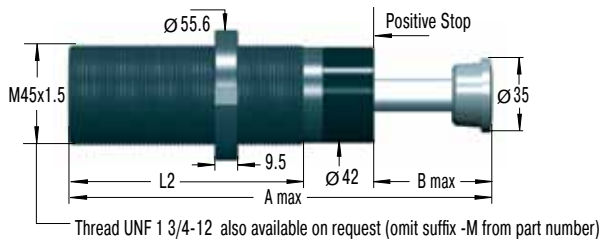

S45

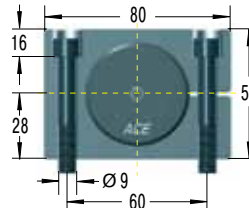
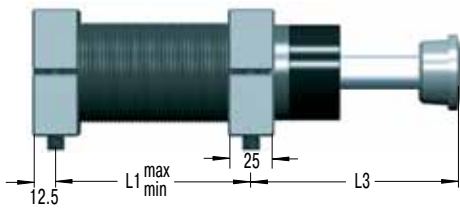

Side Foot Mounting Kit

S45 = 2 flanges + 4 screws M8x50, DIN 912
 Because of the thread pitch the fixing holes for the second foot mount should only be drilled and tapped after the first foot mount has been fixed in position.

Tightening torque: 27 Nm
 Clamping torque: > 350 Nm

C45

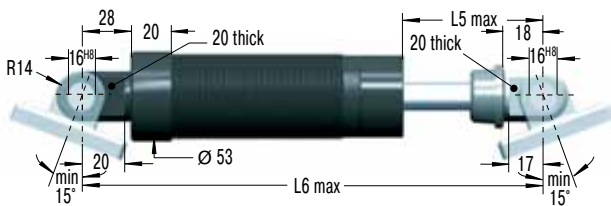

SF45

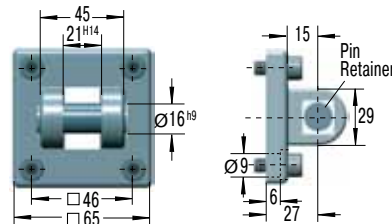

Clevis Mounting Kit

C45 = 2 clevis eyes. Delivered assembled to shock absorber.
 Use positive stop at both ends of travel.

Clevis Flange

SF45 = flange + 4 screws M8x20, DIN 912
 Tightening torque: 7.5 Nm
 Clamping torque: > 140 Nm
Secure with pin or use additional bar.
Due to limited force capacity the respective ability should be reviewed by ACE.

Dimensions

Type	Stroke mm	A max	B max	L1 min	L1 max	L2	L3	L5 max	L6 max
SC4525M	25	189	25	50	112	139	62.5	68	244
SC4550M	50	265	50	64	162	190	87.5	93	320

Capacity Chart

Type Part Number	Max. Energy Capacity		1 Effective Weight me		Min. Return Force N	Max. Return Force N	Rod Reset Time s	Max. Side Load Angle °	Weight kg
	W ₃ Nm/Cycle	W ₄ Nm/h	me min. kg	me max. kg					
SC4525M-5	340	107 000	3 400	6 800	67	104	0.8	4	1.27
SC4525M-6	340	107 000	6 350	13 600	67	104	0.8	4	1.27
SC4525M-7	340	107 000	12 700	22 679	67	104	0.8	4	1.27
SC4525M-8	340	107 000	20 411	39 000	67	104	0.8	4	1.27
SC4550M-5	680	112 000	6 800	12 246	47	242	1.0	3	1.49
SC4550M-6	680	112 000	11 790	26 988	47	242	1.0	3	1.49
SC4550M-7	680	112 000	25 854	44 225	47	242	1.0	3	1.49

¹ The effective weight range limits can be raised or lowered to special order.

BV Side Load Adaptor

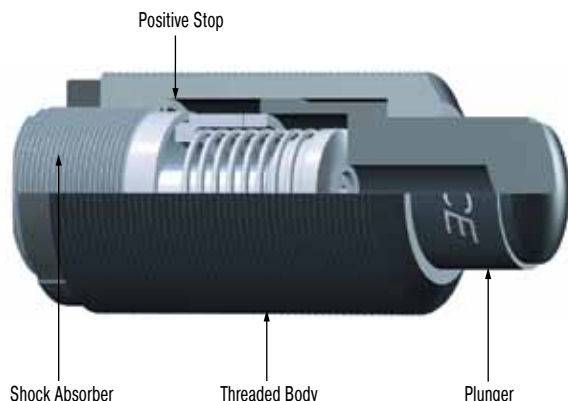

For side load impact angles from 3° to 25°

With side load impact angles of more than 3° the operation lifetime of the shock absorber reduces rapidly due to increased wear of rod bearings. The optional BV side load adaptor provides long lasting solution.

BV3325 (M45x1.5) for MC, MA, ML3325M (M33x1.5)

BV3350 (M45x1.5) for MC, MA, ML3350M (M33x1.5)

BV4525 (M64x2) for MC, MA, ML4525M (M45x1.5)

BV4550 (M64x2) for MC, MA, ML4550M (M45x1.5)

BV6425 (M90x2) for ML6425M (M64x2)

BV6450 (M90x2) for MC, MA, ML6450M (M64x2)

Material: Threaded body and plunger: Hardened high tensile steel. Hardened 610 HV1.

Mounting: Directly mount the shock absorber/side mount assembly on the outside thread of the side load adaptor or by using the QF flange. You cannot use a foot mount.

Calculation example and installation hints see page 38.

PB Steel Shroud

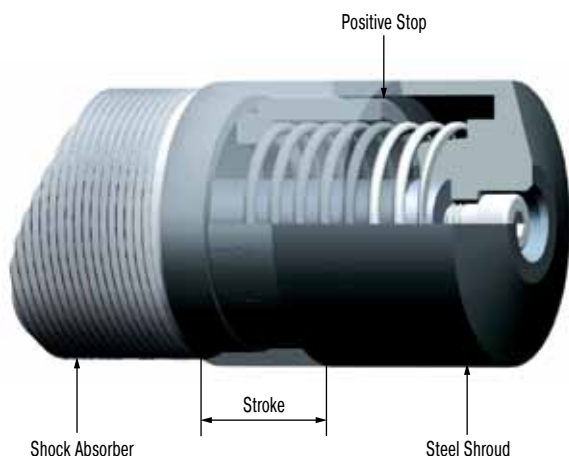

For thread sizes M33x1.5, M45x1.5 and M64x2 with 25 or 50 mm stroke

Grinding beads, sand, welding splatter, paints and adhesives etc. can adhere to the piston rod. They then damage the rod seals and the shock absorber quickly fails. In many cases the installation of the optional steel shroud can provide worthwhile protection and increase lifetime.

Material: Hardened high tensile steel.

Mounting: To mount the PB steel shroud it is necessary to remove the rod end button of the shock absorber.

Note! When installing don't forget to allow operating space for the shroud to move as the shock absorber is cycled.

AS Switch Stop Collar

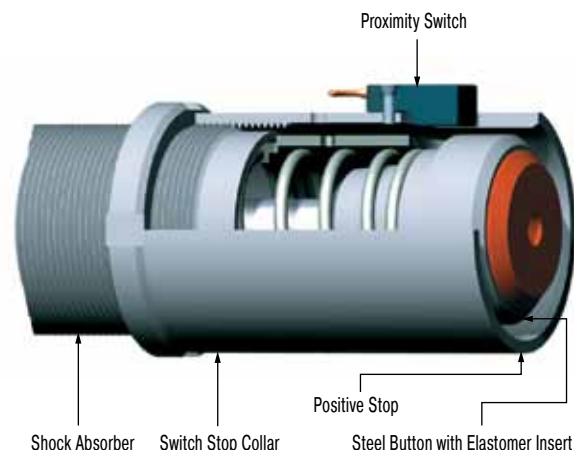

For thread sizes M33x1.5 and M45x1.5

The ACE stop light switch stop collar combination serves as a safety element to provide stroke position information for automatically sequenced machines. The compact construction allows its use in nearly any application. The standard rod button is detected by the proximity switch at the end of its stroke to provide switch actuation. The switch is normally open when the shock absorber is extended and only closes when it has completed its operating stroke. The AS switch stop collar combination is only delivered ready mounted onto the shock absorber c/w the switch.

Material: Hardened high tensile steel.

For circuit diagram of proximity switch see page 39.

A01

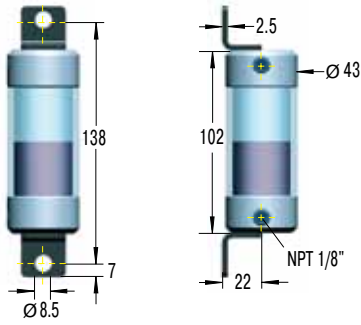

Oil capacity 20 cm³
Material: Alu. caps and polycarbonate body.

1 A03



Oil capacity 370 cm³
Material: Steel

1 A0691



Oil capacity 2600 cm³
Material: Steel

¹ Detail drawings on request

Max. pressure 8 bar. Max. temperature 80 °C.

Oil filling: ATF-Oil 42 cSt at 40 °C for all shock absorbers in MAGNUM Series. Mount air/oil tank higher than shock absorber. Bleed all air from system before operating.

Attention: Exhaust tank before carrying out service. Check valve holds pressure!

Suggested air/oil tanks in accordance with W₄ ratings

Part Numbers

Type	With Tank Examples 1-4		With Recirc. Circuits Ex. 5-6		Conn. Pipe. Ø Min.
	Tank	Non-Return Valve	Tank	Non-Return Valve	
MCA, MAA, MLA33...	AO1	CV1/8	A03	CV1/4	4
MCA, MAA, MLA45...	AO1	CV1/8	A03	CV3/8	6
MCA, MAA, MLA64...	AO3	CV1/4	A0691	CV1/2	8
CAA, AA2...	A0691	CV1/2	A082	CV3/4	15
CAA, AA3...	A0691	CV1/2	A082	CV3/4	19
CAA4...	A082	CV3/4	A082	CV3/4	38

A082 details on request

Connection Examples Air/Oil Tanks

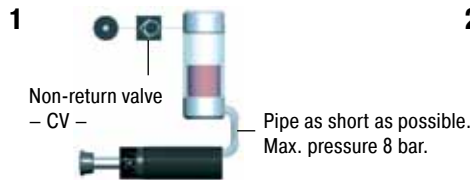

Piston rod returns immediately to extended position when load moves away. Operation without main air supply possible for short periods.



Return stroke may be sequenced by pneumatic valve at any desired time. No return force until valve energised.

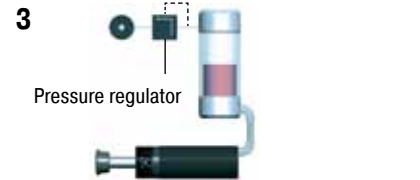

Return force can be adjusted by pressure regulator. Ensure safe minimum pressure to return shock absorber.



Spring return with air/oil tank. No air supply connected. Note: Will extend return time.

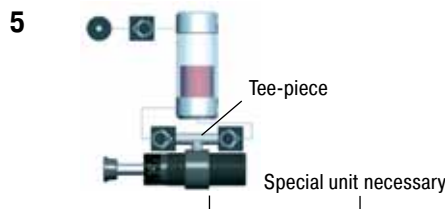

Oil recirculation circuit for extreme high cycle rates. Warm oil is positively circulated through air/oil tank for increased heat dissipation.

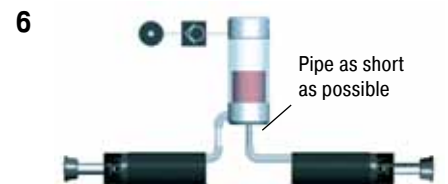

Connection of two shock absorbers to one air/oil tank is possible. Use next larger size tank. Combination with examples 2, 3 and 5 possible.

Thread Sizes for connection to air/oil tank

Type	Thread Bottom	² Thread Side
MCA, MAA, MLA33	¹ G1/8 inside	G1/8 inside
MCA, MAA, MLA45	G1/8 inside	G1/8 inside
MCA, MAA, MLA64	G1/4 inside	G1/4 inside

¹ adapted
² on request (add suffix -PG/-P)

Part Numbers: CV...

Max. pressure: 20 bar
Max. temperature: 95 °C
Suitable for: Oil, air, water.
Material: Aluminium

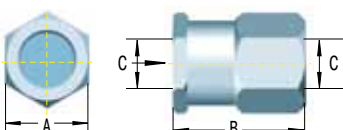

Non-Return Valves

Type	A	B	C
CV1/8	19	24	1/8-27 NPT
CV1/4	29	33	1/4-18 NPT
CV3/8	29	33	3/8-18 NPT
CV1/2	41	40	1/2-14 NPT
CV3/4	48	59	3/4-14 NPT

The **CA2 to CA4** complete the ACE product range of self-compensating shock absorbers. With these units ACE has a continuous range of self-compensating units to handle **effective weights from 0.3 kg up to 326 000 kg**. The robust CA series units are designed for really heavy duty applications. Damage caused by errors in adjustment setting is ruled out by their self-compensating design. You can select the correct model for your application using the ACE Selection Program or by using the capacity chart. The CA units are maintenance-free and self-contained with an energy capacity of up to 126 500 Nm.

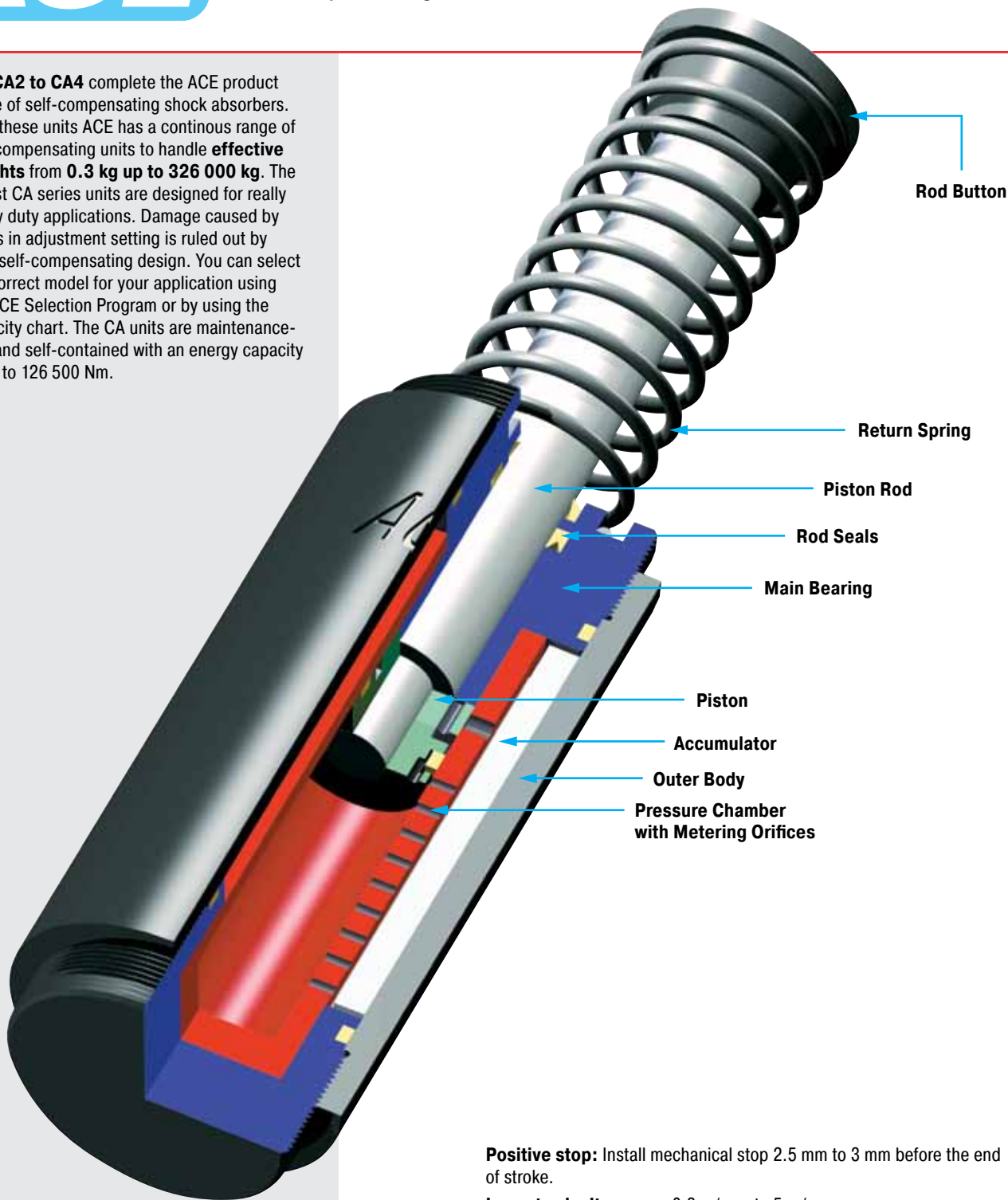

Positive stop: Install mechanical stop 2.5 mm to 3 mm before the end of stroke.

Impact velocity range: 0.3 m/s up to 5 m/s

Operating fluid: Automatic Transmission Fluid (ATF)

Material: Body and accessories: Steel with black oxide finish. Piston rod: Steel hardened and chrome plated. Rod end button: Steel hardened with black oxide finish. Return spring: Zinc plated. For optimum heat dissipation do not paint outer body.

Capacity rating: For emergency use only applications it may be possible to exceed published energy per cycle (W_3) figures. Please consult ACE for further details.

Mounting: In any position

Operating temperature range: -12 °C to 85 °C

On request: Special oils, or for higher or lower impact velocities outside range shown above, or other options please consult ACE.



The adjustable shock absorbers of the **ACE product series A1½ to A3** cover an **effective weight range from 0.3 kg up to 204 000 kg**. The robust A series units are designed for really heavy duty applications. The units are adjusted by means of a socket head screw in the rear end. The adjustable A series can replace the older SAHS series units with the same mounting dimensions. (Ask ACE for assistance.) The A units are maintenance-free and self-contained.

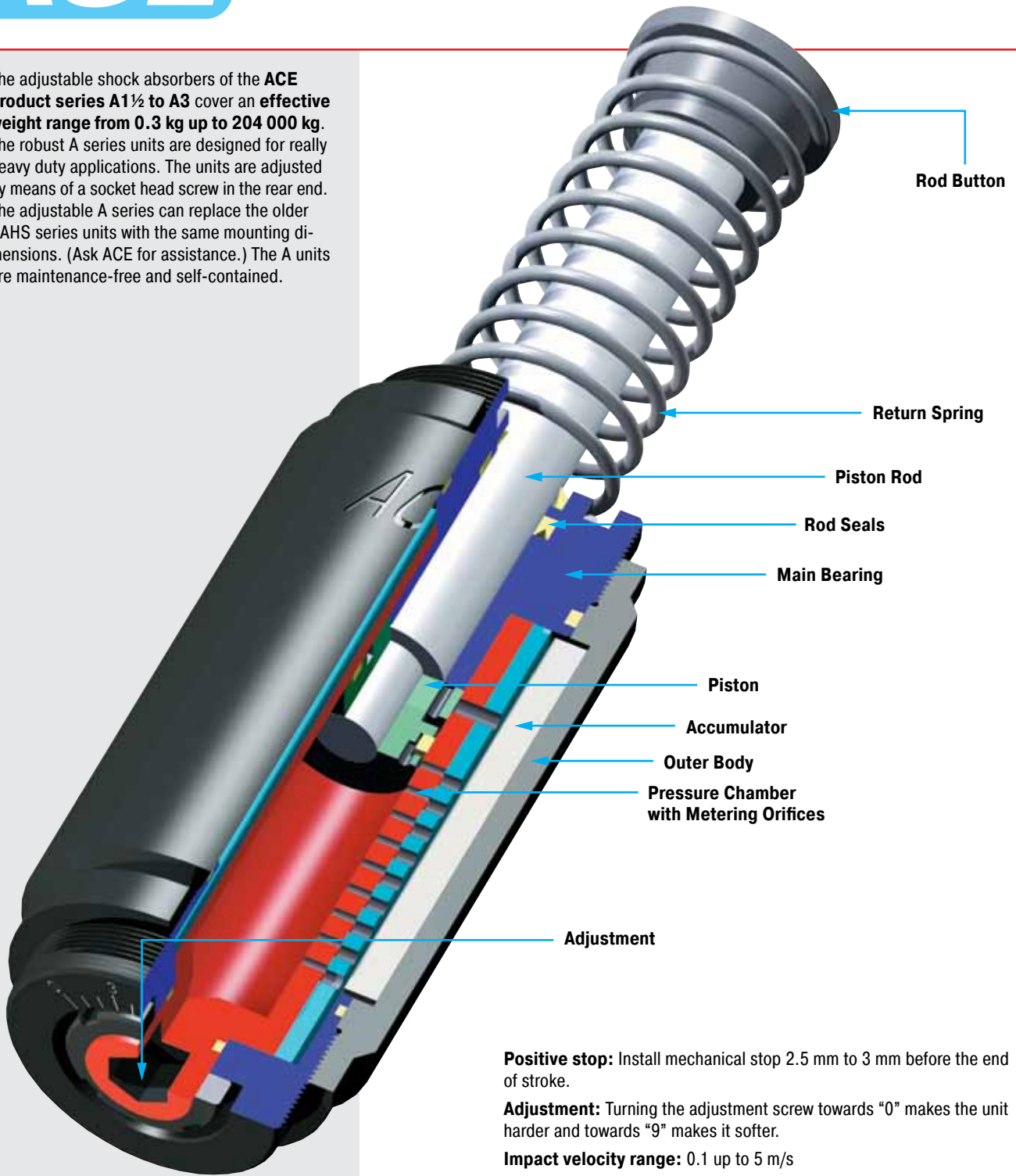

Positive stop: Install mechanical stop 2.5 mm to 3 mm before the end of stroke.

Adjustment: Turning the adjustment screw towards "0" makes the unit harder and towards "9" makes it softer.

Impact velocity range: 0.1 up to 5 m/s

Operating fluid: Models A1½: HLP46. Models A2 and A3: Automatic Transmission Fluid (ATF).

Material: Body and accessories: Steel with black oxide finish. Piston rod: Steel hardened and chrome plated. Rod end button: Steel hardened with black oxide finish. Return spring: Zinc plated. For optimum heat dissipation do not paint outer body.

Capacity rating: For emergency use only applications it may be possible to exceed published energy per cycle (W_3) figures. Please consult ACE for further details.

Mounting: In any position

Operating temperature range: -12 °C to 85 °C

On request: Special oils, or for higher or lower impact velocities outside range shown above, or other options please consult ACE.



Rear Flange -R

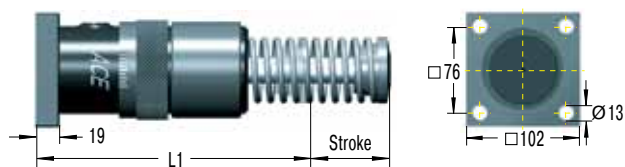

Front Flange -F

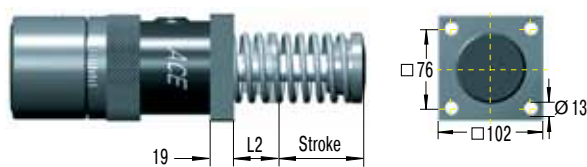

Clevis Mounting -C



Due to limited force capacity the respective ability should be reviewed by ACE.

Foot Mounting -S

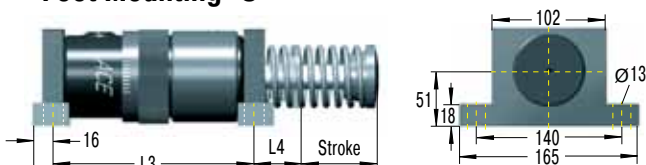

Not available on 2" stroke models.

Install mechanical stop 2.5 mm to 3 mm before end of stroke.

Ordering Example

Adjustable _____
 Bore Size Ø 1½" _____
 Stroke Length 2" = 50.8 mm _____
 Rear Flange Mounting _____

A1½x2R

Model Type Prefix

- A = self-contained with return spring
(This is standard model)
- AA = air/oil return without return spring.
Use only with external air/oil tank.
- NA = self-contained without return spring
- SA = air/oil return with return spring.
Use only with external air/oil tank.

Dimensions

Type	Stroke mm	L1	L2	L3	L4	L5
A1½x2	50	195.2	54.2	–	–	277.8 - 328.6
A1½x3½	89	233	54.2	170	58.6	316.6 - 405.6
A1½x5	127	271.5	54.2	208	58.6	354.8 - 481.8
A1½x6½	165	329	73	246	78	412 - 577

Capacity Chart

Type	Max. Energy Capacity			1 Effective Weight me		Min. Return Force N	Max. Return Force N	Rod Reset Time s	Max. Side Load Angle °	Weight kg
	2 W ₃ Nm/Cycle	3 W ₄ Self-Contained Nm/h	3 W ₄ with Air/Oil Tank Nm/h	me min. kg	me max. kg					
A1½x2	2 350	362 000	452 000	195	32 000	160	210	0.1	5	7.55
A1½x3½	4 150	633 000	791 000	218	36 000	110	210	0.25	4	8.9
A1½x5	5 900	904 000	1 130 000	227	41 000	90	230	0.4	3	9.35
A1½x6½	7 700	1 180 000	1 469 000	308	45 000	90	430	0.4	2	11.95

¹ The effective weight range limits can be raised or lowered to special order.

² For emergency use only applications it may be possible to exceed these max. capacity ratings. Please consult ACE for further details.

³ Figures for oil recirculation systems on request.

Rear Flange -R

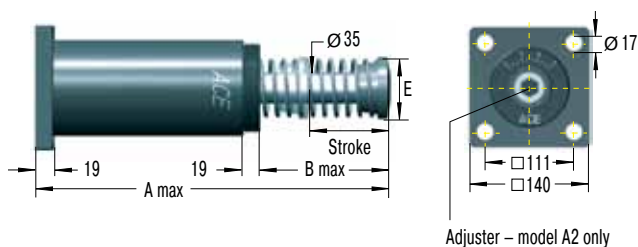

Front Flange -F

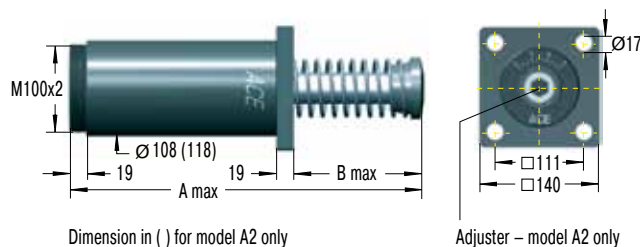

Foot Mounting -SM

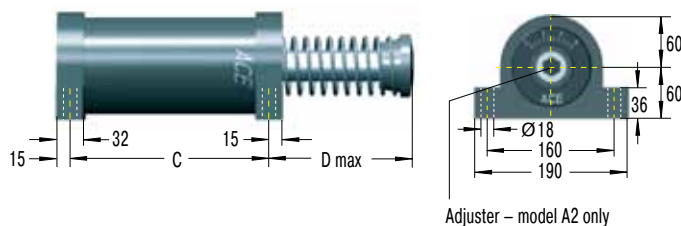

Dimensions of clevis mountings available on request.

NOTE! For replacement of existing SAHS 2" foot mounted units order the old type foot mounting S2-A.

Ordering Example

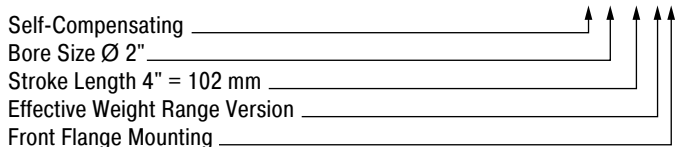

Model Type Prefix

- A, CA = self-contained with return spring
(This is standard model)
- AA, CAA = air/oil return without return spring.
Use only with external air/oil tank.
- NA, CNA = self-contained without return spring
- SA, CSA = air/oil return with return spring.
Use only with external air/oil tank.

Dimensions

Type	Stroke mm	A max	B max	C	D max	E
2x2	50	313	110	173	125	70
2x4	102	414	160	224	175	70
2x6	152	516	211	275	226	70
2x8	203	643	287	326	302	92
2x10	254	745	338	377	353	108

Capacity Chart CA2

Type	Max. Energy Capacity			1 Effective Weight me				Min. Return Force N	Max. Return Force N	Rod Reset Time s	Max. Side Load Angle °	Weight kg
	2 W ₃ Nm/Cycle	3 W ₄ Self-Contained Nm/h	3 W ₄ with Air/Oil Tank Nm/h	Soft		Hard						
				-1 min. max. kg	-2 min. max. kg	-3 min. max. kg	-4 min. max. kg					
CA2x2	3 600	1 100 000	1 350 000	700 - 2 200	1 800 - 5 400	4 500 - 13 600	11 300 - 34 000	210	285	0.25	3	12.8
CA2x4	7 200	1 350 000	1 700 000	1 400 - 4 400	3 600 - 11 000	9 100 - 27 200	22 600 - 68 000	150	285	0.5	3	14.8
CA2x6	10 800	1 600 000	2 000 000	2 200 - 6 500	5 400 - 16 300	13 600 - 40 800	34 000 - 102 000	150	400	0.6	3	16.9
CA2x8	14 500	1 900 000	2 400 000	2 900 - 8 700	7 200 - 21 700	18 100 - 54 400	45 300 - 136 000	230	650	0.7	3	19.3
CA2x10	18 000	2 200 000	2 700 000	3 600 - 11 000	9 100 - 27 200	22 600 - 68 000	56 600 - 170 000	160	460	0.80	3	22.8

Capacity Chart A2

Type	Max. Energy Capacity			1 Effective Weight me		Min. Return Force N	Max. Return Force N	Rod Reset Time s	Max. Side Load Angle °	Weight kg
	2 W ₃ Nm/Cycle	3 W ₄ Self-Contained Nm/h	3 W ₄ with Air/Oil Tank Nm/h	me min. kg	me max. kg					
A2x2	3 600	1 100 000	1 350 000	250	77 000	210	285	0.25	3	14.3
A2x4	9 000	1 350 000	1 700 000	250	82 000	150	285	0.5	3	16.7
A2x6	13 500	1 600 000	2 000 000	260	86 000	150	400	0.6	3	19.3
A2x8	19 200	1 900 000	2 400 000	260	90 000	230	650	0.7	3	22.3
A2x10	23 700	2 200 000	2 700 000	320	113 000	160	460	0.8	3	26.3

1 The effective weight range limits can be raised or lowered to special order.

2 For emergency use only applications it may be possible to exceed these max. capacity ratings. Please consult ACE for further details.

3 Figures for oil recirculation systems on request.

Rear Flange -R

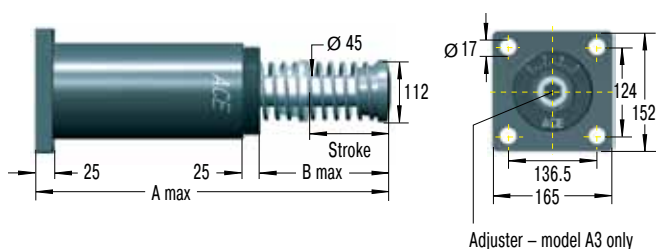

Front Flange -F

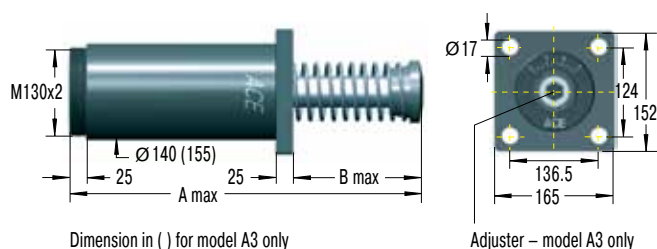

Foot Mounting -S

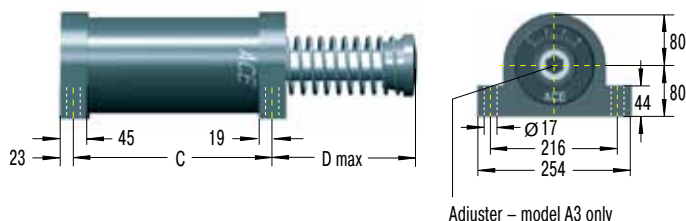

Dimensions of clevis mountings available on request.

NOTE! For replacement of existing SAHS 3" foot mounted units please consult ACE.

Ordering Example

Adjustable _____
 Bore Size Ø 3" _____
 Stroke Length 8" = 203 mm _____
 Rear Flange Mounting _____

A3x8R

Model Type Prefix

- A, CA = self-contained with return spring
(This is standard model)
- AA, CAA = air/oil return without return spring.
Use only with external air/oil tank.
- NA, CNA = self-contained without return spring
- SA, CSA = air/oil return with return spring.
Use only with external air/oil tank.

Dimensions

Type	Stroke mm	A max	B max	C	D max
3x5	127	490,5	211	254	224
3x8	203	641	286	330	300
3x12	305	890	434	432	447

Capacity Chart CA3

Type	Max. Energy Capacity			1 Effective Weight me				Min. Return Force N	Max. Return Force N	Rod Reset Time s	Max. Side Load Angle °	Weight kg
	2 W ₃ Nm/Cycle	3 W ₄ Self-Contained Nm/h	3 W ₄ with Air/Oil Tank Nm/h	Soft		Hard						
				-1 min. max. kg	-2 min. max. kg	-3 min. max. kg	-4 min. max. kg					
CA3x5	14 125	2 260 000	2 800 000	2 900 - 8 700	7 250 - 21 700	18 100 - 54 350	45 300 - 135 900	270	710	0.6	3	28.9
CA3x8	22 600	3 600 000	4 520 000	4 650 - 13 900	11 600 - 34 800	29 000 - 87 000	72 500 - 217 000	280	740	0.8	3	33.4
CA3x12	33 900	5 400 000	6 780 000	6 950 - 20 900	17 400 - 52 200	43 500 - 130 450	108 700 - 326 000	270	730	1.2	3	40.6

Capacity Chart A3

Type	Max. Energy Capacity			1 Effective Weight me		Min. Return Force N	Max. Return Force N	Rod Reset Time s	Max. Side Load Angle °	Weight kg
	2 W ₃ Nm/Cycle	3 W ₄ Self-Contained Nm/h	3 W ₄ with Air/Oil Tank Nm/h	me min. kg	me max. kg					
A3x5	15 800	2 260 000	2 800 000	480	154 000	270	710	0.6	3	35.5
A3x8	28 200	3 600 000	4 520 000	540	181 500	280	740	0.8	3	39.6
A3x12	44 000	5 400 000	6 780 000	610	204 000	270	730	1.2	3	35.5

¹ The effective weight range limits can be raised or lowered to special order.

² For emergency use only applications it may be possible to exceed these max. capacity ratings. Please consult ACE for further details.

³ Figures for oil recirculation systems on request.

Rear Flange -R

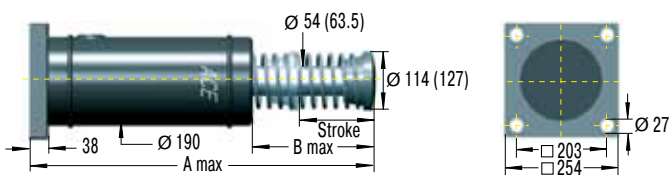

Dimension in () for model CA4x16 only

Front Flange -F

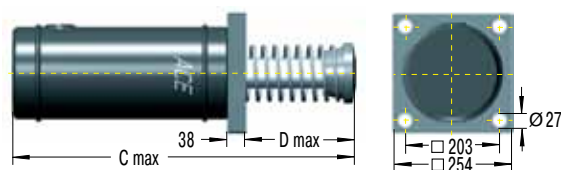

6 Tapped Holes (Primary Mounting) FRP

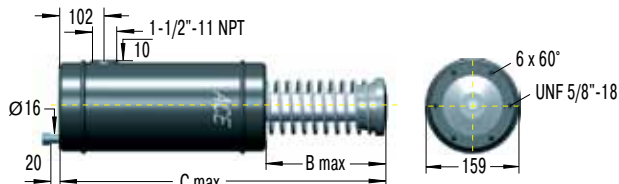

Foot Mounting -S

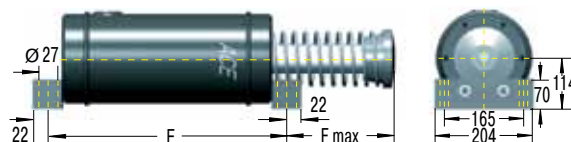

Dimensions of clevis mountings available on request.

Ordering Example

Self-Compensating _____
 Bore Size Ø 4" _____
 Stroke Length 8" = 203 mm _____
 Effective Weight Range Version _____
 Rear Flange Mounting _____

CA4x8-5R

Model Type Prefix

- CA = self-contained with return spring
(This is standard model)
- CAA = air/oil return without return spring.
Use only with external air/oil tank.
- CNA = self-contained without return spring
- CSA = air/oil return with return spring.
Use only with external air/oil tank.

Dimensions CA/CNA/CSA

Type	Stroke mm	A	B	C	D	E	F
4x6	152	716	278	678	240	444	256
4x8	203	818	329	780	291	495	307
4x16	406	1 300	608.5	1 262.6	569	698	585

Dimensions of model CAA available on request.

Capacity Chart CA4

Type	Max. Energy Capacity				1 Effective Weight me			Min. Return Force N	Max. Return Force N	Rod Reset Time s	Weight kg
	2 W ₃ Nm/Cycle	W ₄ Self- Contained Nm/h	W ₄ with Air/Oil Tank Nm/h	W ₄ with Oil Recirculation Nm/h	Soft		Hard				
					-3 min. max. kg	-5 min. max. kg	-7 min. max. kg				
CA4x6	47 500	3 000 000	5 100 000	6 600 000	3 500 - 8 600	8 600 - 18 600	18 600 - 42 700	480	1 000	1.8	60
CA4x8	63 300	3 400 000	5 600 000	7 300 000	5 000 - 11 400	11 400 - 25 000	25 000 - 57 000	310	1 000	2.3	68
CA4x16	126 500	5 600 000	9 600 000	12 400 000	10 000 - 23 000	23 000 - 50 000	50 000 - 115 000	310	1 000	Ask	146

¹ The effective weight range limits can be raised or lowered to special order.

² For emergency use only applications it may be possible to exceed these max. capacity ratings. Please consult ACE for further details.

1 ACE Shock absorbers for pneumatic cylinders

For: optimum deceleration
 higher speeds
 smaller cylinders
 reduced air consumption
 smaller valves and pipework

Example: MA3350M-Z (cylinder mounting)

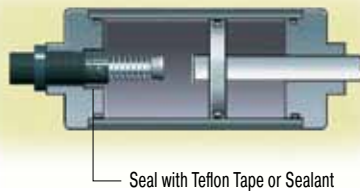

With heavy loads or high velocities normal cylinder cushions are often overloaded. This causes shock loading leading to premature cylinder failure or excessive maintenance. Using oversized cylinders to withstand this shock loading is not the best solution since this considerably increases air consumption and costs.

2 Side load adaptor for high side load angles

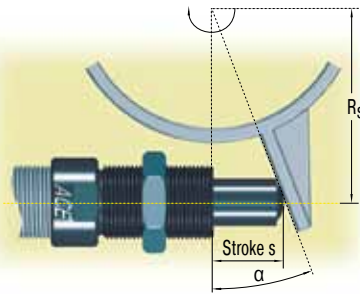

The side loading is removed from the shock absorber piston rod leading to considerably longer life. See pages 38 and 54 for more details.

3 Undamped free travel with damped end position

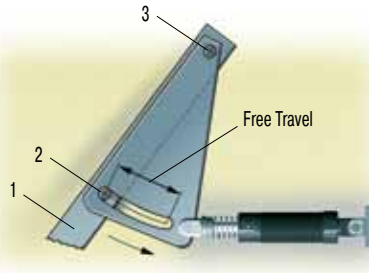

The lever 1 swings with the pin 2 in a slotted hole around pivot point 3. The lever is smoothly decelerated at the extreme end of its travel.

4 One shock absorber for both ends of travel

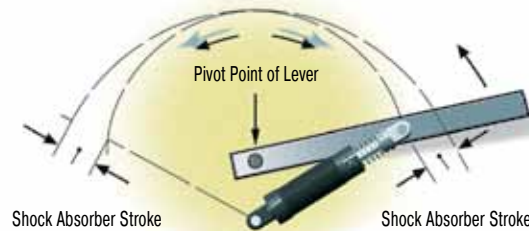

It is possible to use only one shock absorber for both end positions by using different pivot points as shown.

Tip: Leave approx. 1.5 mm of shock absorber stroke free at each end of travel.

5 Double acting shock absorber



With a little additional work a normal uni-directional shock absorber can be converted to work in 2 directions by using a mechanism as shown.

6 Air bleed collar



By using the air bleed adaptor the operating lifetime of shock absorbers in aggressive environments can be considerably increased. The adaptor protects the shock absorber seals from cutting fluids, cleaning agents, cooking oil etc. by using a low pressure air bleed. For more details see page 37.

7 Double stroke length

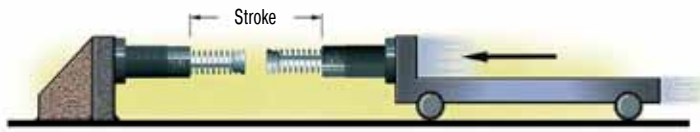

50% lower reaction force (Q)

50% lower deceleration (a)

By driving 2 shock absorbers against one another 'nose-to-nose', the effective stroke length can be doubled.

8 Ride over latch

8.1



8.2

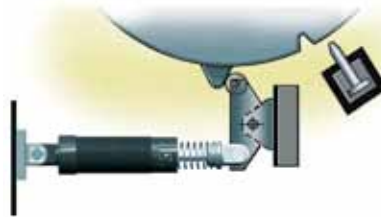

8.1 The latch absorbs the kinetic energy so that the object contacts the fixed stop gently.

8.2 The latch absorbs the rotational energy of the turntable etc. The turntable can then be held in the datum position with a lock bolt or similar.

9 Rotary actuator or rack and pinion drive

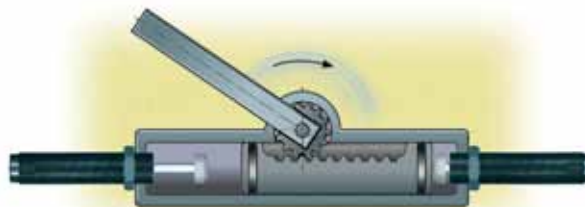

The use of ACE shock absorbers allows higher operating speeds and weights as well as protecting the drive mechanism and housing from shock loads.

10 Adjustable stop clamp e. g. for handling equipment

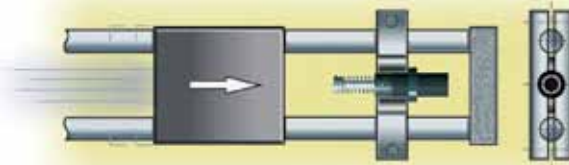

The gentle deceleration of ACE shock absorbers makes the use of adjustable stop clamps possible and removes any chance of the clamp slipping. The kinetic energy is completely removed before the mechanical stop is reached thus making high index speeds possible.

11 Ride-over latch e. g. fire door

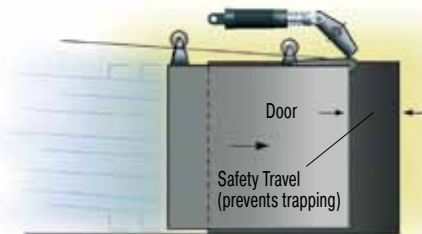

The fire door travels quickly until it reaches the lever. It is then gently decelerated by the lever mounted shock absorber and closes without shock or danger to personnel.

12 Increasing stroke length mechanically

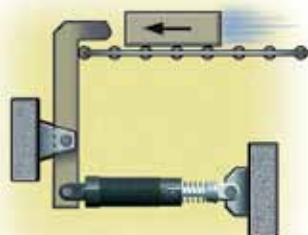

By means of a lever the effective stroke length can be increased and mounting space to the left reduced.



Constant resisting force

ACE miniature shock absorbers are the right alternative.

This pneumatic module for high precision, high speed motion intentionally abandoned pneumatic end-of-travel damping. The compact miniature shock absorbers of the type **MC25MH-NB** decelerate the linear motion safer and faster when reaching the end-of-travel position. They accept the moving load gently and decelerate it smoothly throughout the entire stroke length. Additional advantages: simpler construction, smaller pneumatic valves, lower maintenance costs as well as reduced compressed air consumption.



Miniature shock absorber in linear pneumatic module

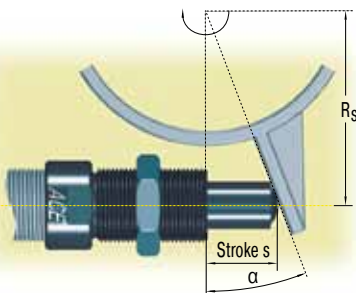

Soft end-of-travel damping on rotary movements

ACE miniature shock absorbers optimize production with minimum expenditure.

The cycle rate for an assembly line producing electronic components was increased to 3600 units/hr by using ACE shock absorbers. Miniature shock absorbers type **SC190M-1** decelerate the rapid transfer movements on the production line and using soft damping methods optimize the pick up and set down of components. This soft deceleration technique has increased production and reduced maintenance on the portal and rotary actuator modules. The optional side load adaptor protects the shock absorber from high side load forces and increases the operating lifetime. Using ACE shock absorbers reduces maintenance costs by 50% and running costs by 20%, diminishing energy consumption.



Optimised production in the electronics industry

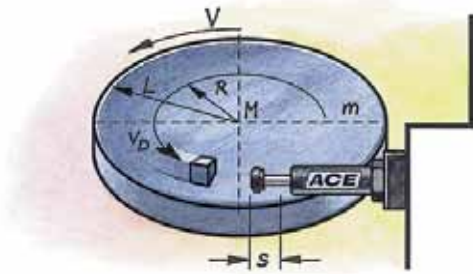

Safe swiveling

ACE industrial shock absorbers offer safety to spare for swiveling or braking of large telescope.

The optical system of this telescope for special observations is moveable in two space coordinates. The structure in which the telescope is mounted weighs 15 000 kg and consists of a turntable with drives and two wheel disks rotating on bearings. It enables a rotation by $\pm 90^\circ$ from horizon to horizon. To safeguard the telescope in case of overshooting the respective swiveling limits, industrial shock absorbers of the type **ML3325M** are used as braking elements. Should the telescope inadvertently overshoot the permissible swivel range, they will safely damp the travel of the valuable telescope.



Perfect overshoot protection for precision telescope

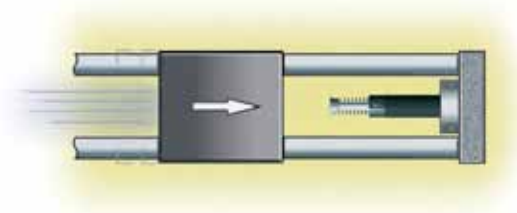

Quicker, gentle positioning

ACE industrial shock absorbers optimize portal for machine loading and increase productivity.

This device driven by piston rodless pneumatic cylinders, in which two gripper slides are moving independently of each other at speeds of 2 to 2.5 m/sec., is equipped with industrial shock absorbers as brake systems. Their function is to stop a mass of 25 kg up to 540 times per hour. The model **MC3350M-1-S** was chosen for this application, allowing easy and extremely accurate adjustment of the end positions of the adjustable limit stops. In comparison to brake systems with other function principles, shock absorbers allow higher travel speeds and shorter cycle sequences.

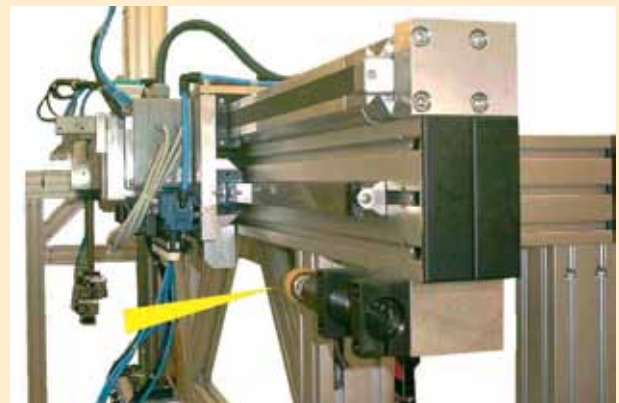

Industrial shock absorbers optimize portal operation

Based on the innovative design concepts of the MAGNUM range, ACE introduces the **SCS33 to SCS64 series of safety shock absorbers**. Designed to provide machine protection in an emergency runaway situation the SCS33 to SCS64 series provide a cost effective method of protecting vital machinery in emergency stop situations. Specially optimised orificing design provides **extremely high capacity** in a compact envelope size making them ideal for critical applications on portal gantry systems, automatic transfer machines and robot systems where an emergency runaway could otherwise result in expensive damage or danger. With up to 300 % higher capacity than other shock absorber designs the SCS33 to 64 range provides true linear deceleration protecting vital equipment at an affordable cost.

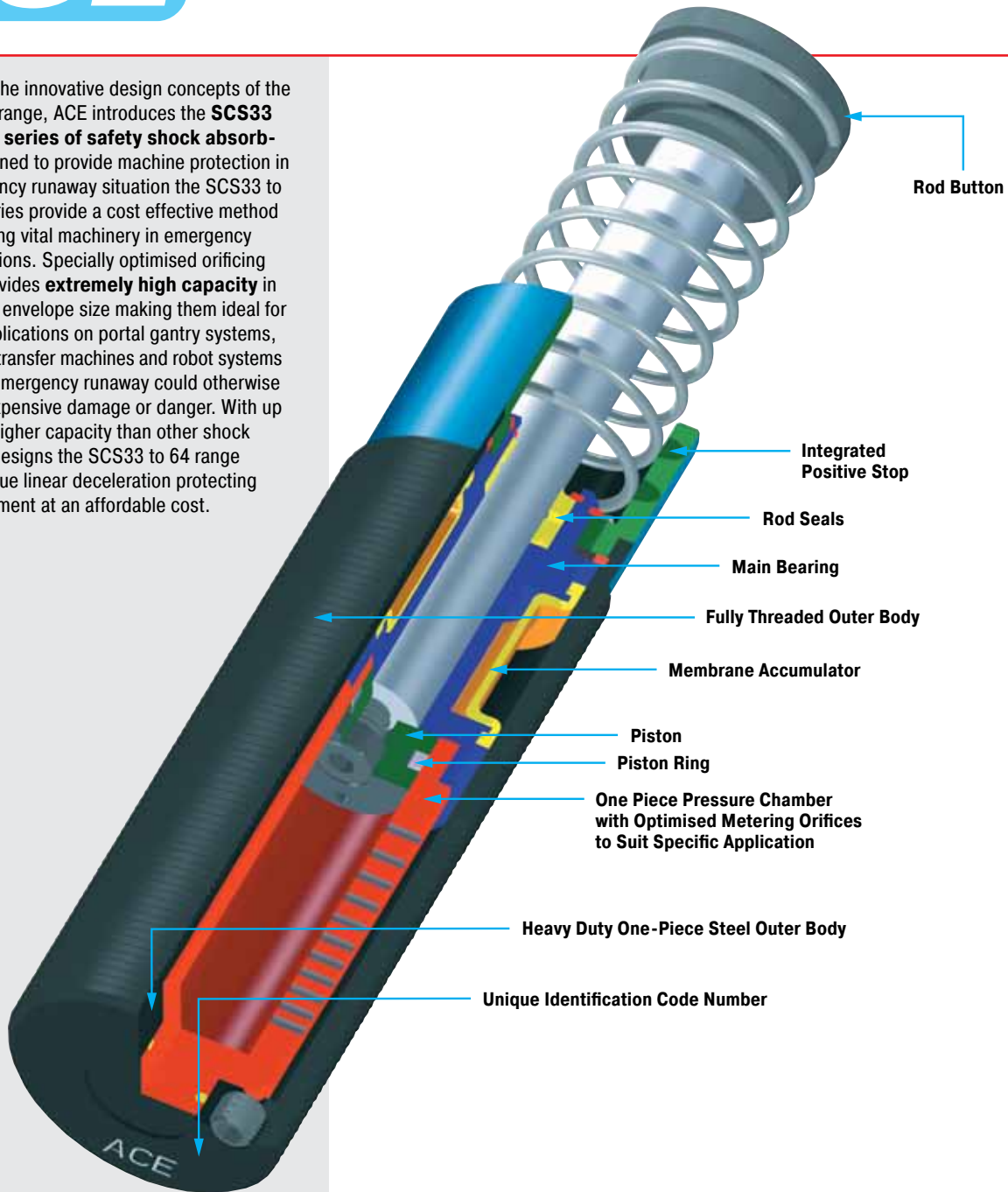

- Impact cycles per hour:** max. 1
- Life expectancy:** Self-compensating version: max. 1000 cycles. Optimised version: max. 5 cycles.
- Impact velocity range:** On request
- Operating fluid:** Automatic Transmission Fluid (ATF)
- Material:** Shock absorber body: Nitride hardened steel. Accessories: Steel with black oxide finish. Piston rod: Steel hardened and chrome plated. Rod end button: Hardened steel with black oxide finish. Return Spring: Zinc plated or plastic-coated.
- Energy capacity W_3 :** At max. side load angle do not exceed 80 % of rated max. energy capacity below.
- Mounting:** In any position
- Operating temperature range:** -12 °C to 70 °C. For higher and lower temperatures consult ACE.
- In creep speed:** The shock absorber can be pushed through its stroke. In creep speed conditions the shock absorber provides minimal resistance and there is no braking effect.



Issue 7.2014. Specifications subject to change

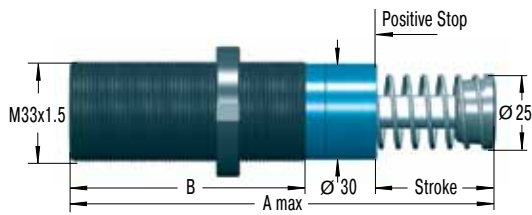

Standard Dimensions

NM33

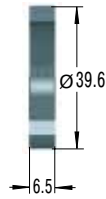

Locking Ring

QF33

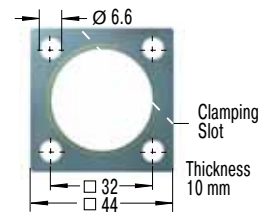

Square Flange

Install with 4 machine screws
Tightening torque: 11 Nm
Clamping torque: > 90 Nm

S33

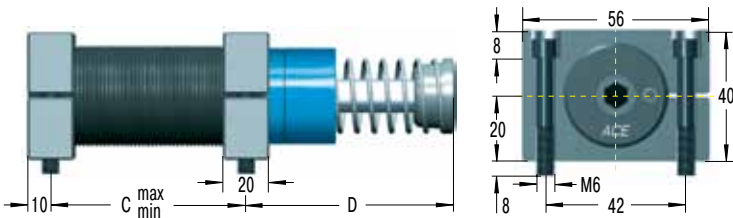

Side Foot Mounting Kit

S33 = 2 flanges + 4 screws M6x40, DIN 912
Because of the thread pitch the fixing holes for the second foot mount should only be drilled and tapped after the first foot mount has been fixed in position.

Tightening torque: 11 Nm (screws)
Clamping torque: > 90 Nm

Ordering Example

Safety Shock Absorber _____
Thread Size M33 _____
Max. Stroke without Positive Stop 50 mm _____
Identification No. assigned by ACE _____
Please indicate identification no. in case of replacement order

SCS33-50-1xxxx

Complete Details Required when Ordering

Moving load m (kg)
Impact velocity range v (m/s) max.
Creep speed vs (m/s)
Motor power P (kW)
Stall torque factor ST (normal 2.5)
Number of absorbers in parallel n

or technical data according to formulae and calculations on page 13 to 15.

The calculation and selection of the correct ACE safety shock absorber for your application should be referred to ACE for approval and assignment of unique identification number.

Dimensions and Capacity Chart

Type	Stroke mm	A max	B	C min	C max	D	Max. Energy Capacity		Min. Return Force N	Max. Return Force N	Max. Side Load Angle °	Weight kg
							Self-Compensating W ₃ Nm/Cycle	Optimised Version W ₃ Nm/Cycle				
SCS33-25	23	138	83	25	60	68	310	500	45	90	3	0.45
SCS33-50	48.5	189	108	32	86	93	620	950	45	135	2	0.54

For other stroke lengths, special options (such as higher or lower impact velocity etc.), please consult ACE.

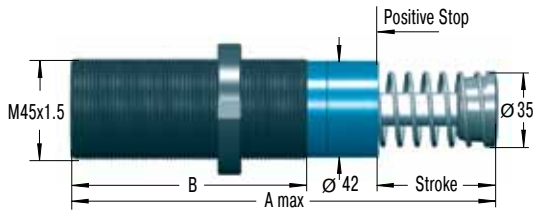

Standard Dimensions

NM45

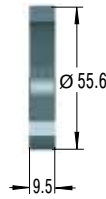

Locking Ring

QF45

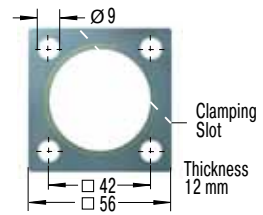

Square Flange

Install with 4 machine screws
Tightening torque: 27 Nm
Clamping torque: > 200 Nm

S45

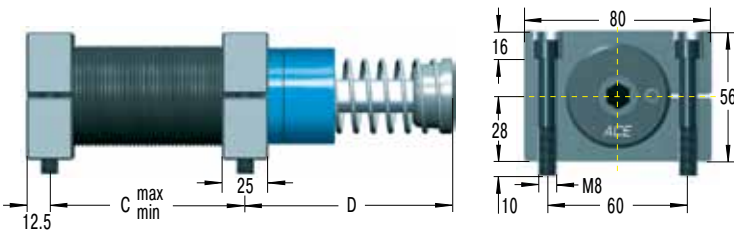

Side Foot Mounting Kit

S45 = 2 flanges + 4 screws M8x50, DIN 912
Because of the thread pitch the fixing holes for the second foot mount should only be drilled and tapped after the first foot mount has been fixed in position.

Tightening torque: 27 Nm (screws)
Clamping torque: > 350 Nm

Ordering Example

Safety Shock Absorber _____
Thread Size M45 _____
Max. Stroke without Positive Stop 50 mm _____
Identification No. assigned by ACE _____
Please indicate identification no. in case of replacement order

SCS45-50-1xxxx

Complete Details Required when Ordering

Moving load m (kg)
Impact velocity range v (m/s) max.
Creep speed vs (m/s)
Motor power P (kW)
Stall torque factor ST (normal 2.5)
Number of absorbers in parallel n

or technical data according to formulae and calculations on page 13 to 15.

The calculation and selection of the correct ACE safety shock absorber for your application should be referred to ACE for approval and assignment of unique identification number.

Dimensions and Capacity Chart

Type	Stroke mm	A max	B	C min	C max	D	Max. Energy Capacity		Min. Return Force N	Max. Return Force N	Max. Side Load Angle °	Weight kg
							Self-Compensating W ₃ Nm/Cycle	Optimised Version W ₃ Nm/Cycle				
SCS45-25	23	145	95	32	66	66	680	1 200	70	100	3	1.13
SCS45-50	48.5	195	120	40	92	91	1 360	2 350	70	145	2	1.36
SCS45-75	74	246	145	50	118	116	2 040	3 500	50	180	1	1.59

For other stroke lengths, special options (such as higher or lower impact velocity etc.), please consult ACE.

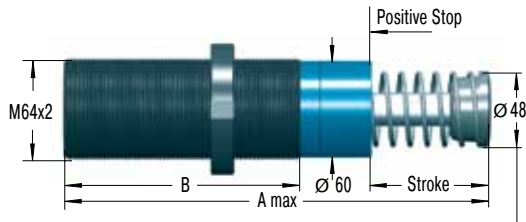

Note: 150 mm stroke model does not include stop collar and positive stop is provided by the rod button (Ø 60 mm)

Standard Dimensions

NM64

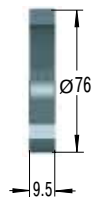

Locking Ring

QF64

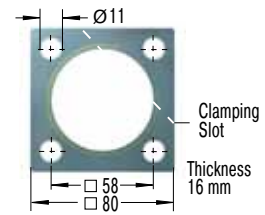

Square Flange

Install with 4 machine screws
Tightening torque: 50 Nm
Clamping torque: > 210 Nm

S64

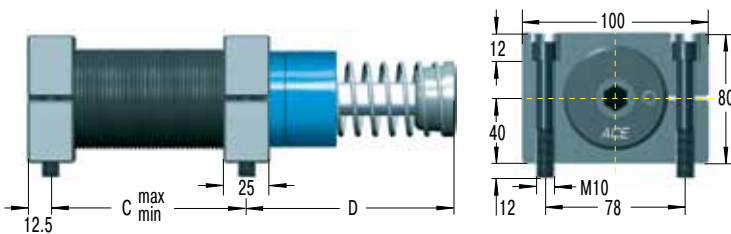

Side Foot Mounting Kit

S64 = 2 flanges + 4 screws M10x80, DIN 912
Because of the thread pitch the fixing holes for the second foot mount should only be drilled and tapped after the first foot mount has been fixed in position.

Tightening torque: 50 Nm (screws)
Clamping torque: > 350 Nm

Ordering Example

Safety Shock Absorber _____
Thread Size M64 _____
Max. Stroke without Positive Stop 50 mm _____
Identification No. assigned by ACE _____
Please indicate identification no. in case of replacement order

SCS64-50-1xxxx

Complete Details Required when Ordering

Moving load m (kg)
Impact velocity range v (m/s) max.
Creep speed vs (m/s)
Motor power P (kW)
Stall torque factor ST (normal 2.5)
Number of absorbers in parallel n

or technical data according to formulae and calculations on page 13 to 15.

The calculation and selection of the correct ACE safety shock absorber for your application should be referred to ACE for approval and assignment of unique identification number.

Dimensions and Capacity Chart

Type	Stroke mm	A max	B	C min	C max	D	Max. Energy Capacity		Min. Return Force N	Max. Return Force N	Max. Side Load Angle °	Weight kg
							Self-Compensating W ₃ Nm/Cycle	Optimised Version W ₃ Nm/Cycle				
SCS64-50	48.5	225	140	50	112	100	3 400	6 000	90	155	3	3.18
SCS64-100	99.5	326	191	64	162	152	6 800	12 000	105	270	2	4.2
SCS64-150	150	450	241	80	212	226	10 200	18 000	75	365	1	5.65

For other stroke lengths, special options (such as higher or lower impact velocity etc.), please consult ACE.

ACE safety shock absorbers are self-contained and maintenance-free. They are designed for emergency deceleration and are an economic alternative to industrial shock absorbers. The **SCS series** units are available with operating strokes up to 1200 mm and are specially orificed to provide a smooth constant deceleration throughout their entire stroke length. The internal hydraulic pressure and thus the braking force, is maintained at a constant safe level to bring the fast moving load gently to rest in an emergency. Applications specially include conveyor systems, automated storage, cranes and heavy machines. Optional rod sensor available for indicating the complete extension of the piston rod. ACE

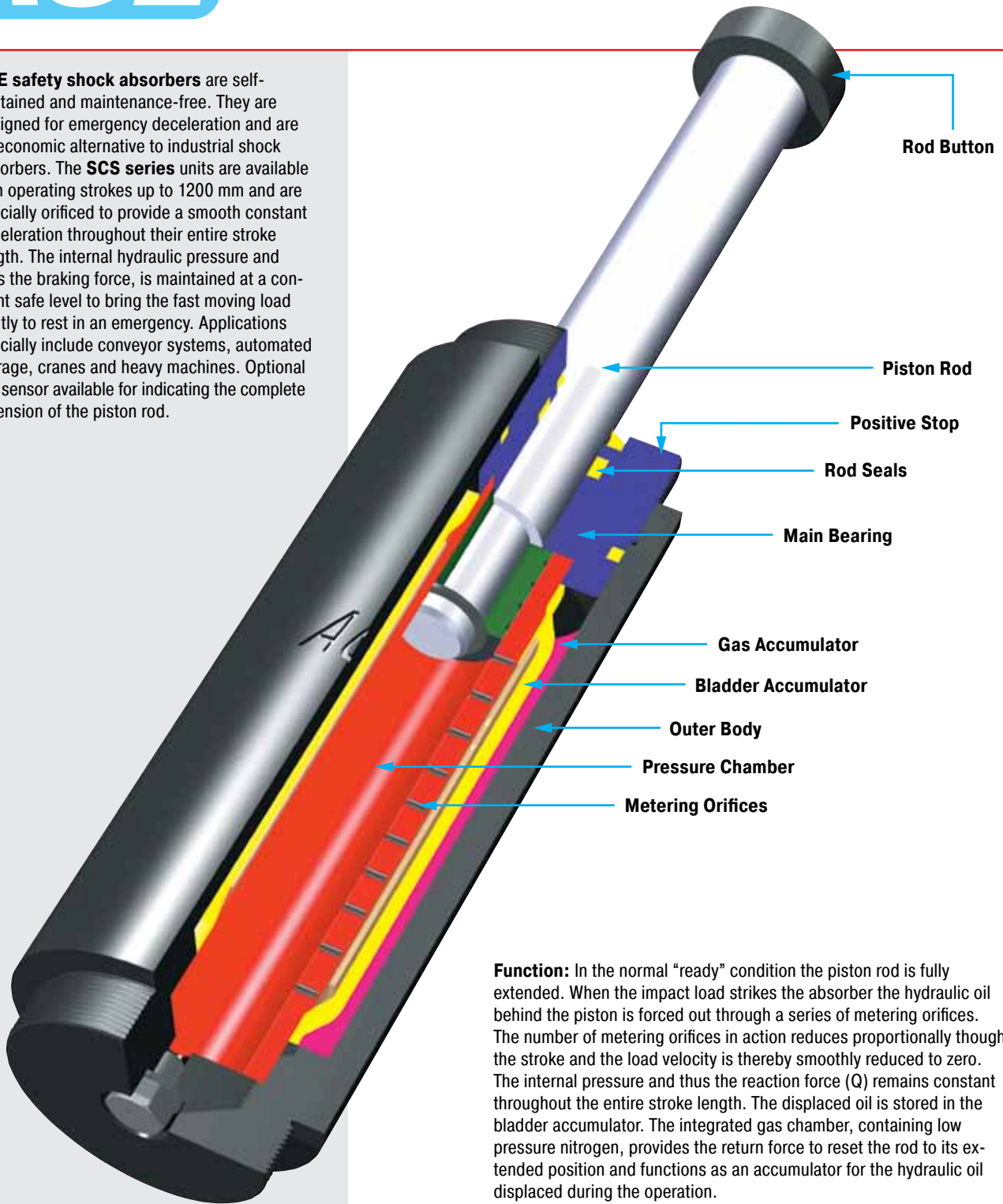

Function: In the normal "ready" condition the piston rod is fully extended. When the impact load strikes the absorber the hydraulic oil behind the piston is forced out through a series of metering orifices. The number of metering orifices in action reduces proportionally though the stroke and the load velocity is thereby smoothly reduced to zero. The internal pressure and thus the reaction force (Q) remains constant throughout the entire stroke length. The displaced oil is stored in the bladder accumulator. The integrated gas chamber, containing low pressure nitrogen, provides the return force to reset the rod to its extended position and functions as an accumulator for the hydraulic oil displaced during the operation.

Material: Steel body with black oxide finish. Piston rod hard chrome plated.

Energy capacity W_3 : At max. side load angle do not exceed 80 % of rated max. energy capacity below.

Filling pressure: Approx. 2 bar

Operating temperature range:
-12 °C to 66 °C

On request: Integrated rod sensor for indicating the complete extension of the piston rod. Type normally closed or normally open, option PNP or NPN switch.

In creep speed: It is possible to use up to approx. 60 % of the buffer stroke. In creep speed conditions the shock absorber provides minimal resistance and there is no braking effect.



Rear Flange -R

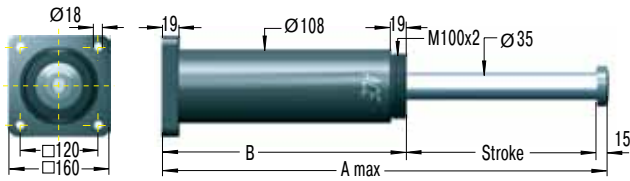

Front Flange -F

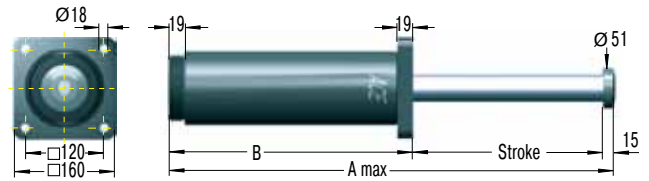

Foot Mounting -S

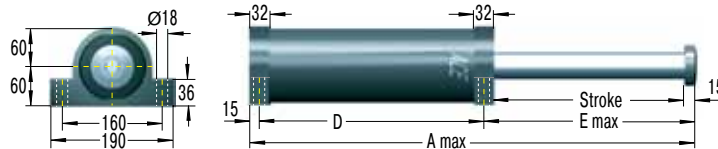

Ordering Example

Safety Shock Absorber _____
 Bore Size Ø 38 mm _____
 Stroke 400 mm _____
 Mounting Style: Front Flange _____
 Identification No. assigned by ACE _____

SCS38-400-F-X

Please indicate identification no. in case of replacement order

Complete Details Required when Ordering

Moving load m (kg)
 Impact velocity range v (m/s) max.
 Creep speed vs (m/s)
 Motor power P (kW)
 Stall torque factor ST (normal 2.5)
 Number of absorbers in parallel n

or technical data according to formulae and calculations on page 13 to 15.

The calculation and selection of the correct ACE safety shock absorber for your application should be referred to ACE for approval and assignment of unique identification number.

Technical Data

Impact velocity range: 0.9 to 4.6 m/s

Reacting force Q: At max. capacity rating = **80 kN max.**

Dimensions and Capacity Chart

Type	Stroke mm	A max	B	D	E max	Max. Energy Capacity W ₃ Nm/Cycle	Mounting Style							
							Min. Return Force N		Max. Return Force N		F & S		R	
							Max. Side Load Angle °	Max. Side Load Angle °	Max. Side Load Angle °	Max. Side Load Angle °	F & R Weight kg	S Weight kg		
SCS38-50	50	270	205	175	80	3 600	600	700	5	4	12	13		
SCS38-100	100	370	255	225	132	7 200	600	700	5	4	14	15		
SCS38-150	150	470	305	275	180	10 800	600	700	5	4	16	17		
SCS38-200	200	570	355	325	230	14 400	600	700	5	4	18	19		
SCS38-250	250	670	405	375	280	18 000	600	700	4.7	3.7	20	21		
SCS38-300	300	785	470	440	330	21 600	600	700	3.9	2.9	22	23		
SCS38-350	350	885	520	490	380	25 200	600	700	3.4	2.4	24	25		
SCS38-400	400	1 000	585	555	430	28 800	600	700	3	2	26	27		
SCS38-500	500	1 215	700	670	530	36 000	600	700	2.4	1.4	30	31		
SCS38-600	600	1 430	815	785	630	43 200	600	700	1.9	0.9	34	35		
SCS38-700	700	1 645	930	900	730	50 400	600	700	1.6	0.6	38	39		
SCS38-800	800	1 860	1 045	1 015	830	57 600	600	700	1.3	0.3	43	44		

For other stroke lengths, special options (such as higher or lower impact velocity etc.), please consult ACE.

Rear Flange -R

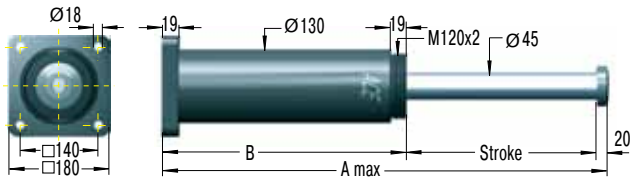

Front Flange -F

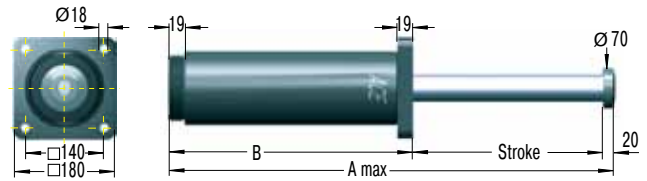

Foot Mounting -S

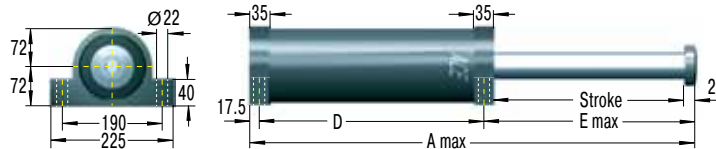

72

Ordering Example

Safety Shock Absorber _____
 Bore Size Ø 50 mm _____
 Stroke 400 mm _____
 Mounting Style: Front Flange _____
 Identification No. assigned by ACE _____
Please indicate identification no. in case of replacement order

SCS50-400-F-X

Complete Details Required when Ordering

Moving load m (kg)
 Impact velocity range v (m/s) max.
 Creep speed vs (m/s)
 Motor power P (kW)
 Stall torque factor ST (normal 2.5)
 Number of absorbers in parallel n

or technical data according to formulae and calculations on page 13 to 15.

The calculation and selection of the correct ACE safety shock absorber for your application should be referred to ACE for approval and assignment of unique identification number.

Technical Data

Impact velocity range: 0.6 to 4.6 m/s

Reacting force Q: At max. capacity rating = **160 kN max.**

Dimensions and Capacity Chart

Type	Stroke mm	A max	B	D	E max	Max. Energy Capacity W ₃ Nm/Cycle	Mounting Style							
							Min. Return Force N	Max. Return Force N	F & S		R		F & R	
									Max. Side Load Angle °	Max. Side Load Angle °	Max. Side Load Angle °	Max. Side Load Angle °	Weight kg	Weight kg
SCS50-100	100	390	270	235	138	14 000	1 000	1 200	5	4	22	23		
SCS50-150	150	490	320	285	188	21 000	1 000	1 200	5	4	25	26		
SCS50-200	200	590	370	335	238	28 000	1 000	1 200	5	4	27	28		
SCS50-250	250	690	420	385	288	35 000	1 000	1 200	4.5	3.5	30	31		
SCS50-300	300	805	485	450	338	42 000	1 000	1 200	3.8	2.8	33	34		
SCS50-350	350	905	535	500	388	49 000	1 000	1 200	3.3	2.3	35	37		
SCS50-400	400	1 020	600	565	438	56 000	1 000	1 200	2.9	1.9	38	40		
SCS50-500	500	1 235	715	680	538	70 000	1 000	1 200	2.3	1.3	44	45		
SCS50-600	600	1 450	830	795	638	84 000	1 000	1 200	1.9	0.9	50	51		
SCS50-700	700	1 665	945	910	738	98 000	1 000	1 200	1.6	0.6	55	57		
SCS50-800	800	1 880	1 060	1 025	838	112 000	1 000	1 200	1.3	0.3	61	63		
SCS50-1000	1 000	2 310	1 290	1 255	1 038	140 000	1 000	1 200	1	0	72	74		

For other stroke lengths, special options (such as higher or lower impact velocity etc.), please consult ACE.

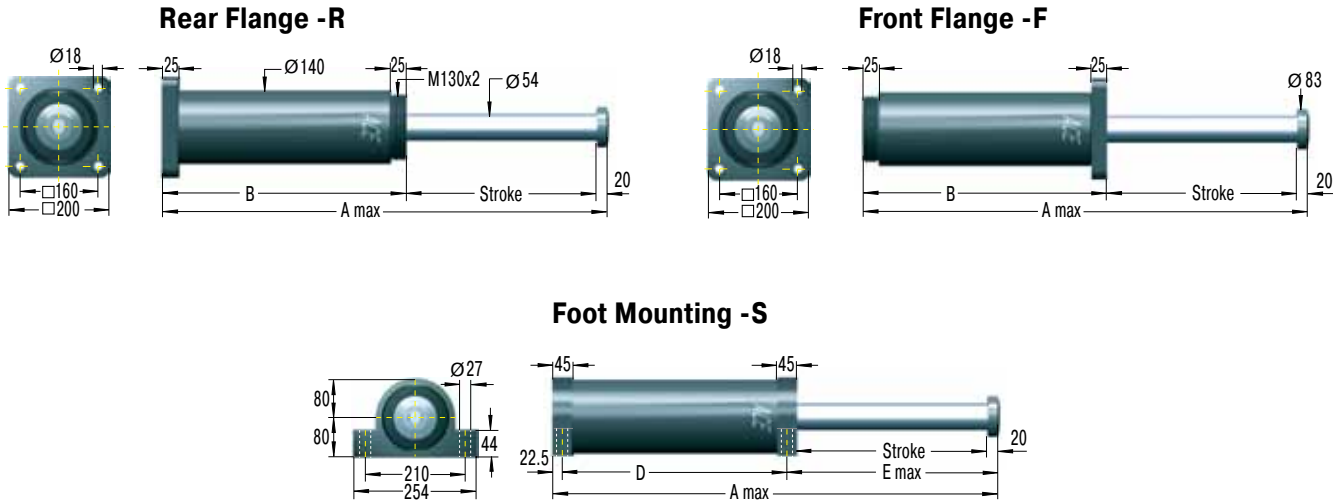

Ordering Example

Safety Shock Absorber _____
 Bore Size Ø 63 mm _____
 Stroke 400 mm _____
 Mounting Style: Front Flange _____
 Identification No. assigned by ACE _____
Please indicate identification no. in case of replacement order

SCS63-400-F-X

Complete Details Required when Ordering

Moving load m (kg)
 Impact velocity range v (m/s) max.
 Creep speed vs (m/s)
 Motor power P (kW)
 Stall torque factor ST (normal 2.5)
 Number of absorbers in parallel n

or technical data according to formulae and calculations on page 13 to 15.

The calculation and selection of the correct ACE safety shock absorber for your application should be referred to ACE for approval and assignment of unique identification number.

Technical Data

Impact velocity range: 0.5 to 4.6 m/s
Reacting force Q: At max. capacity rating = **210 kN max.**

Dimensions and Capacity Chart

Type	Stroke mm	A max	B	D	E max	Max. Energy Capacity W ₃ Nm/Cycle	Mounting Style							
							Min. Return Force N		Max. Return Force N		Mounting Style F & S		Mounting Style R	
							Min. Force N	Max. Force N	Max. Side Load Angle °	Max. Side Load Angle °	F & R Weight kg	S Weight kg		
SCS63-100	100	405	285	240	143	18 000	1 500	2 500	5	4	29	32		
SCS63-150	150	505	335	290	193	27 000	1 500	2 500	5	4	32	35		
SCS63-200	200	605	385	340	243	36 000	1 500	2 500	5	4	36.2	38		
SCS63-250	250	705	435	390	293	45 000	1 500	2 500	5	4	38	42		
SCS63-300	300	805	485	440	343	54 000	1 500	2 500	5	4	41	45		
SCS63-350	350	925	555	510	393	63 000	1 500	2 500	5	4	45	49		
SCS63-400	400	1 025	605	560	443	72 000	1 500	2 500	5	4	48	52		
SCS63-500	500	1 245	725	680	543	90 000	1 500	2 500	4.2	3.2	55	60		
SCS63-600	600	1 445	825	780	643	108 000	1 500	2 500	3.4	2.4	62	66		
SCS63-700	700	1 665	945	900	746	126 000	1 500	2 500	2.9	1.9	69	73		
SCS63-800	800	1 865	1 045	1 000	843	144 000	1 500	2 500	2.5	1.5	75	79		
SCS63-1000	1 000	2 285	1 265	1 220	1 043	180 000	1 500	2 500	1.9	0.9	89	93		
SCS63-1200	1 200	2 705	1 485	1 440	1 243	216 000	1 500	2 500	1.4	0.4	102	106		

For other stroke lengths, special options (such as higher or lower impact velocity etc.), please consult ACE.

Issue 7.2014. Specifications subject to change

ACE safety shock absorbers are self-contained and maintenance-free. They are designed for emergency deceleration and are an economic alternative to industrial shock absorbers. The primary oil seals are protected inside the main body and only a wiper seal is necessary on the piston rod. Dirt or contamination on the piston rod does not cause oil leakage or failure as is often the case with conventional buffers. The integrated gas accumulator enables the **CB Series** safety shock absorbers to provide return forces of up to 71 kN. This high return force is necessary for multiple-bridge cranes where the buffers must separate the bridges after an emergency collision. Normal buffers would remain compressed after such a collision and would not be capable of accepting further impacts. The robust, large dimensioned piston rod bearing system, is designed for very heavy duty use and is equivalent to that used in other buffers 80 % larger in size. The CB series units are custom orificed to suit your specific application and provide a smooth constant deceleration throughout their complete stroke length.

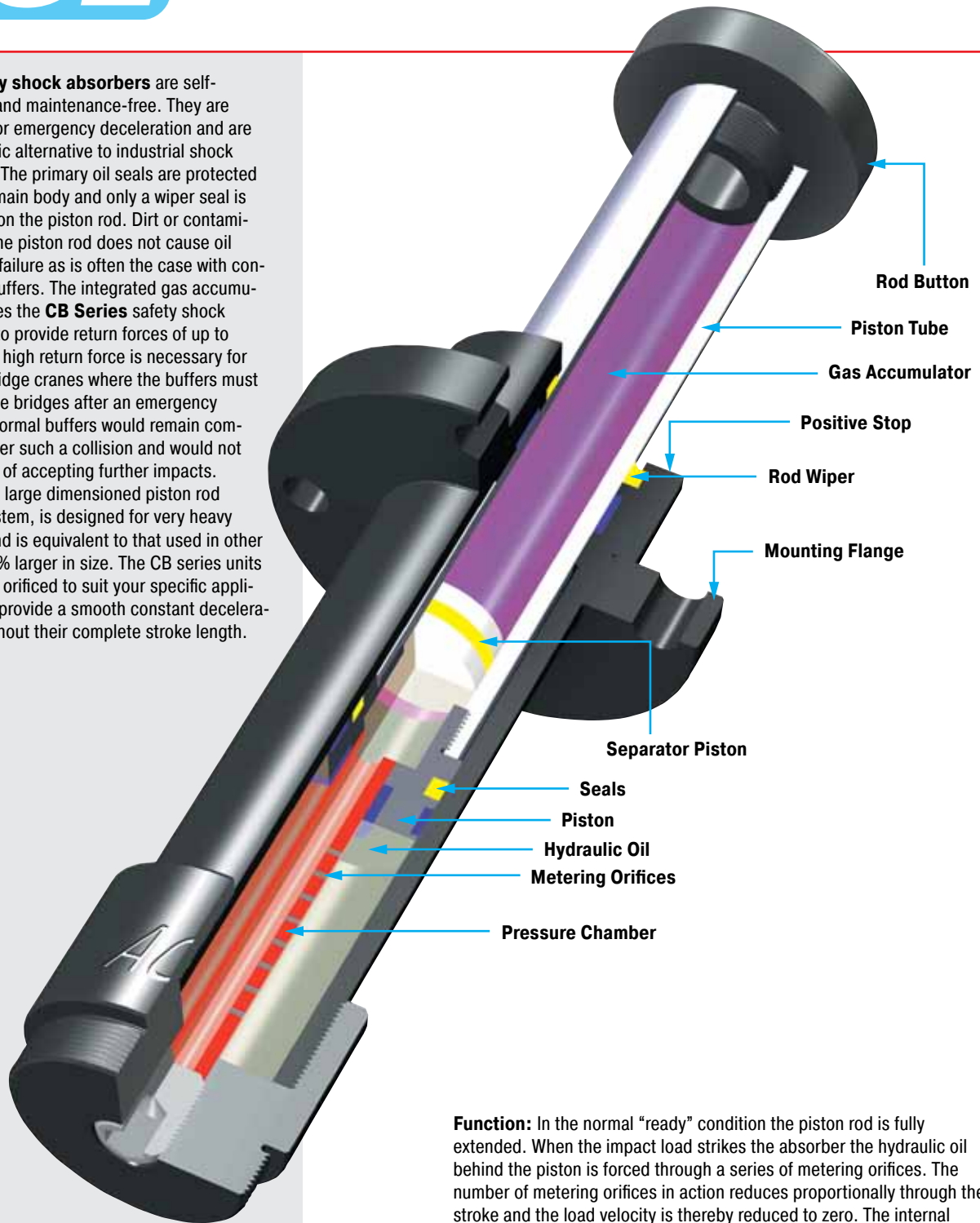

Function: In the normal “ready” condition the piston rod is fully extended. When the impact load strikes the absorber the hydraulic oil behind the piston is forced through a series of metering orifices. The number of metering orifices in action reduces proportionally through the stroke and the load velocity is thereby reduced to zero. The internal pressure and thus the reaction force (Q) remains constant throughout the entire stroke length. The displaced oil is directed inside the piston rod where a separator piston keeps the oil and the nitrogen gas apart. The integrated gas accumulator, containing low pressure nitrogen, provides the high return force to reset the rod to its extended position and generates the high return forces to comply with crane installations.

Impact velocity range:
0.5 to 4.6 m/s

Material: Steel body with black oxide finish. Piston rod hard chrome plated.

Operating temperature range:
-12 °C to 66 °C

Initial fill pressure: governs the rod return force.

In creep speed: The shock absorber can be pushed through its stroke.



Front Flange -F

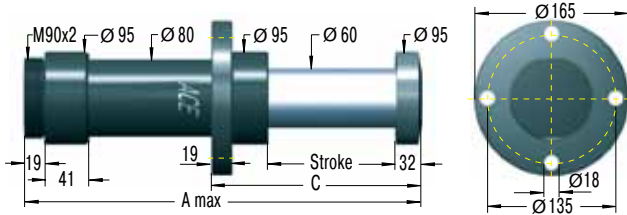

Rear Flange -R

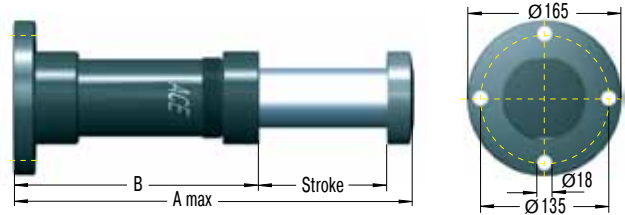

Ordering Example

Safety Shock Absorber _____
 Bore Size Ø 63 mm _____
 Stroke 400 mm _____
 Mounting Style: Front Flange _____
 Identification No. assigned by ACE _____

CB63-400-F-X

Please indicate identification no. in case of replacement order

Complete Details Required when Ordering

Moving load m (kg)
 Impact velocity range v (m/s)max.
 Creep speed vs (m/s)
 Motor power P (kW)
 Stall torque factor ST (normal 2.5)
 Number of absorbers in parallel n

or technical data according to formulae and calculations on page 13 to 15.

The calculation and selection of the correct ACE safety shock absorber for your application should be referred to ACE for approval and assignment of unique identification number.

Technical Data

Reacting force Q: At max. capacity rating = **187 kN max.**

Rod return: Nitrogen accumulator (5.6 bar to 5.9 bar)

Dimensions and Capacity Chart

Type	Stroke mm	A max	B	C	Max. Energy Capacity W ₃ Nm/Cycle	1 Effective Weight me		Min. Return Force N	Max. Return Force N	Max. Side Load Angle °	Weight kg
						me min. kg	me max. kg				
CB63-100	100	420	288	192	16 000	1 510	128 000	1 700	18 500	3.5	12.7
CB63-200	200	700	468	292	32 000	3 020	256 000	1 700	24 000	3	16.7
CB63-300	300	980	648	392	48 000	4 540	384 000	1 700	27 000	2.5	20.8
CB63-400	400	1 260	828	492	64 000	6 050	512 000	1 700	29 000	2	24.8
CB63-500	500	1 540	1 008	592	80 000	7 560	640 000	1 700	30 000	1.5	28.8

¹ The correct effective weight range for your application will be calculated by ACE and should fall within this band.

Special options: Special oils, special flanges, additional corrosion protection etc. available on request.

Front Flange -F

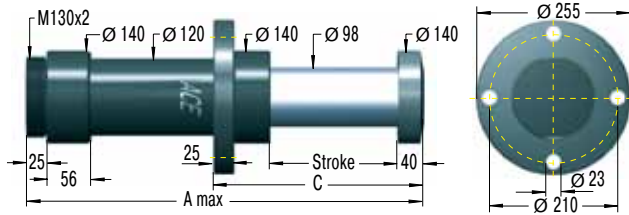

Rear Flange -R

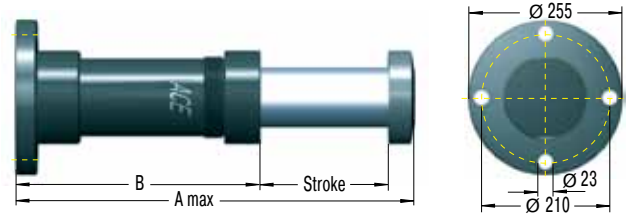

Ordering Example

Safety Shock Absorber _____
 Bore Size Ø 100 mm _____
 Stroke 400 mm _____
 Mounting Style: Front Flange _____
 Identification No. assigned by ACE _____
Please indicate identification no. in case of replacement order

CB100-400-F-X

Complete Details Required when Ordering

Moving load m (kg)
 Impact velocity range v (m/s)max.
 Creep speed vs (m/s)
 Motor power P (kW)
 Stall torque factor ST (normal 2.5)
 Number of absorbers in parallel n

or technical data according to formulae and calculations on page 13 to 15.

The calculation and selection of the correct ACE safety shock absorber for your application should be referred to ACE for approval and assignment of unique identification number.

Technical Data

Reacting force Q: At max. capacity rating = **467 kN max.**

Rod return: Nitrogen accumulator (5.6 bar to 5.9 bar)

Dimensions and Capacity Chart

Type	Stroke mm	A max	B	C	Max. Energy Capacity W ₃ Nm/Cycle	1 Effective Weight me		Min. Return Force N	Max. Return Force N	Max. Side Load Angle °	Weight kg
						me min. kg	me max. kg				
CB100-200	200	735	495	320	80 000	7 560	640 000	4 500	44 000	4	42.5
CB100-300	300	1 005	665	420	120 000	11 340	960 000	4 500	56 000	3.5	50.8
CB100-400	400	1 275	835	520	160 000	15 120	1 280 000	4 500	65 000	3	59.1
CB100-500	500	1 545	1 005	620	200 000	18 900	1 600 000	4 500	71 000	2.5	67.5
CB100-600	600	1 815	1 175	720	240 000	22 680	1 920 000	4 500	76 000	2	75.8

¹ The correct effective weight range for your application will be calculated by ACE and should fall within this band.

Special options: Special oils, special flanges, additional corrosion protection etc. available on request.

Front Flange -F

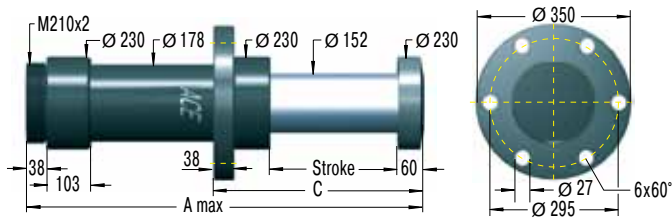

Rear Flange -R

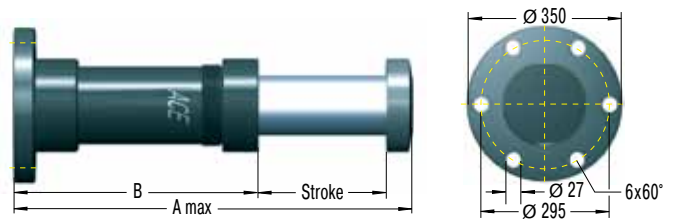

Ordering Example

Safety Shock Absorber _____ **CB160-400-F-X**
 Bore Size Ø 160 mm _____
 Stroke 400 mm _____
 Mounting Style: Front Flange _____
 Identification No. assigned by ACE _____
Please indicate identification no. in case of replacement order

Complete Details Required when Ordering

Moving load m (kg)
 Impact velocity range v (m/s)max.
 Creep speed vs (m/s)
 Motor power P (kW)
 Stall torque factor ST (normal 2.5)
 Number of absorbers in parallel n

or technical data according to formulae and calculations on page 13 to 15.

The calculation and selection of the correct ACE safety shock absorber for your application should be referred to ACE for approval and assignment of unique identification number.

Technical Data

Reacting force Q: At max. capacity rating = **700 kN max.**

Rod return: Nitrogen accumulator (5.6 bar to 5.9 bar)

Dimensions and Capacity Chart

Type	Stroke mm	A max	B	C	Max. Energy Capacity W ₃ Nm/Cycle	1 Effective Weight me		Min. Return Force N	Max. Return Force N	Max. Side Load Angle °	Weight kg
						me min. kg	me max. kg				
CB160-400	400	1 400	940	600	240 000	22 700	1 920 000	11 000	71 000	4	154.6
CB160-600	600	2 000	1 340	800	360 000	34 000	2 880 000	11 000	71 000	3	188
CB160-800	800	2 600	1 740	1 000	480 000	45 400	3 840 000	11 000	71 000	2	221.3

¹ The correct effective weight range for your application will be calculated by ACE and should fall within this band.

Special options: Special oils, special flanges, additional corrosion protection etc. available on request.

The newly-developed EB series offers all the advantages of the CB series such as internal system seals, generously dimensioned piston rod bearings and maximum energy absorption for emergency braking. The internal spring assembly in the piston tube ensures reliable extension of the piston rod following compression. Because of the extension via the spring assembly, the extension forces are reduced significantly in comparison to the CB series. The performance curve and damping characteristics of the maintenance-free and ready-to-install EB safety shock absorber, like all ACE safety shock absorbers, is individually tailored to the relevant application.

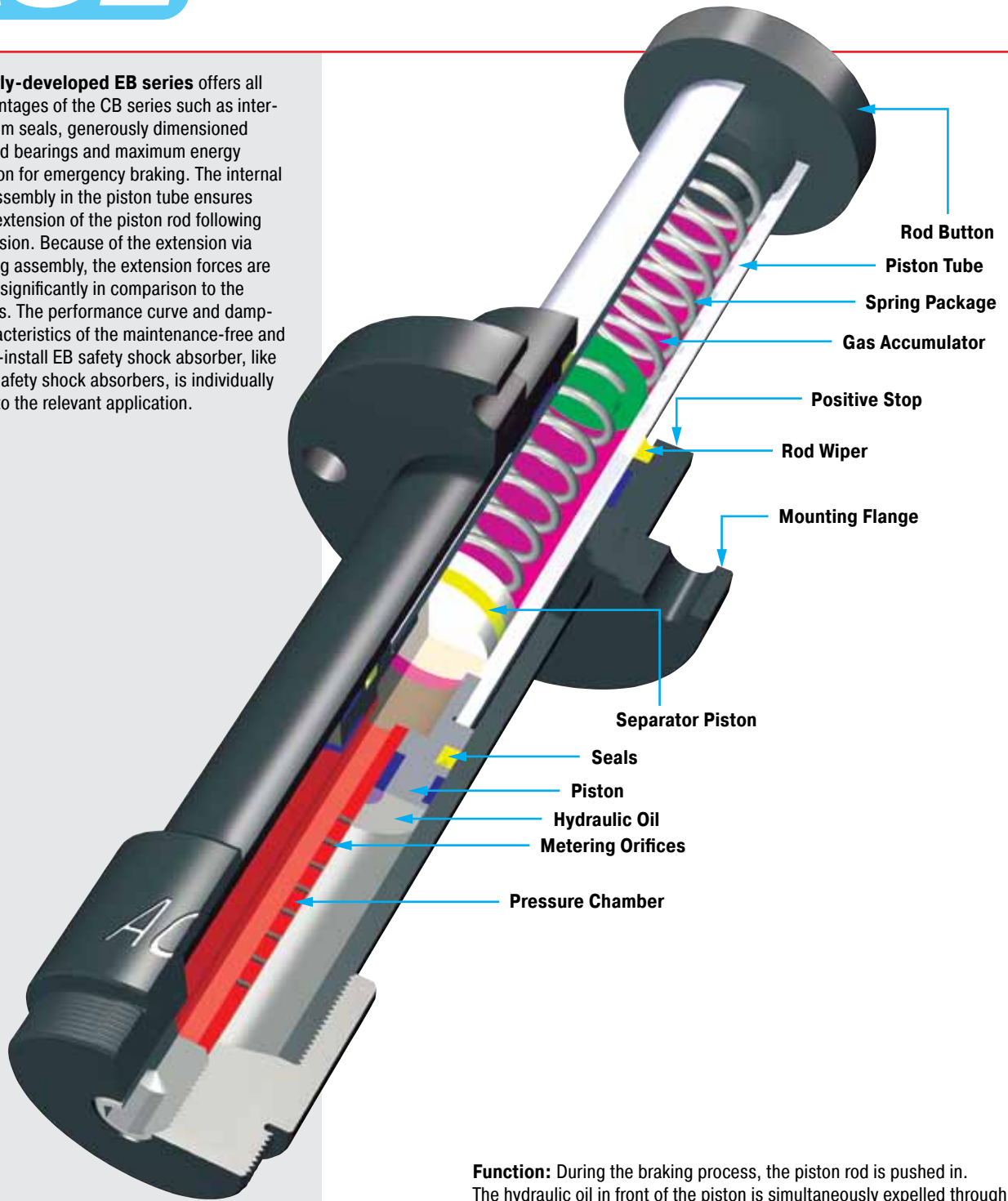

Function: During the braking process, the piston rod is pushed in. The hydraulic oil in front of the piston is simultaneously expelled through all orifice openings. The number of orifice openings in effect reduces in proportion to the stroke movement. The retraction speed is reduced. The back-pressure created in front of the piston, and therefore the counterforce (Q), remain constant during the complete stroke. The oil volume displaced by the piston rod is compensated for by the separating piston. The piston rod is extended again by the spring assembly in the piston tube.

Impact velocity range:
0.5 to 4.6 m/s

Material: Steel body with black oxide finish. Piston rod hard chrome plated.

Operating temperature range:
-12 °C to 66 °C

Initial fill pressure: governs the rod return force.

In creep speed: The shock absorber can be pushed through its stroke.



Front Flange -F

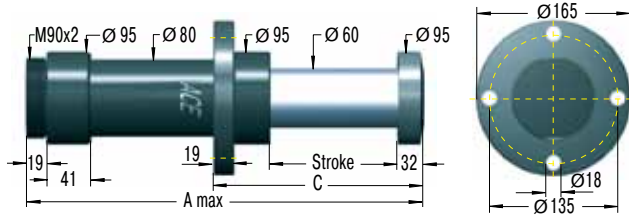

Rear Flange -R

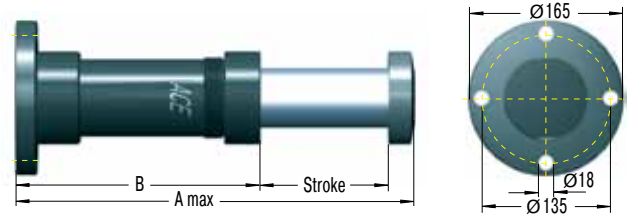

Ordering Example

Safety Shock Absorber _____
 Bore Size Ø 63 mm _____
 Stroke 400 mm _____
 Mounting Style: Front Flange _____
 Identification No. assigned by ACE _____

EB63-400-F-X

Please indicate identification no. in case of replacement order

Complete Details Required when Ordering

Moving load _____ m (kg)
 Impact velocity range _____ v (m/s)max.
 Creep speed _____ vs (m/s)
 Motor power _____ P (kW)
 Stall torque factor _____ ST (normal 2.5)
 Number of absorbers in parallel _____ n

or technical data according to formulae and calculations on page 13 to 15.

The calculation and selection of the correct ACE safety shock absorber for your application should be referred to ACE for approval and assignment of unique identification number.

Technical Data

Reacting force Q: At max. capacity rating = **187 kN max.**

Rod return: Nitrogen accumulator (0.55 bar to 1.03 bar) combined with return spring

Dimensions and Capacity Chart

Type	Stroke mm	A max	B	C	Max. Energy Capacity		1 Effective Weight me		Min. Return Force N	Max. Return Force N	Max. Side Load Angle °	Weight kg
					W ₃ Nm/Cycle	me min. kg	me max. kg					
EB63-100	100	420	288	192	16 000	1 510	128 000	700	6 900	3.5	13.7	
EB63-200	200	700	468	292	32 000	3 020	256 000	770	9 300	3	16.7	
EB63-300	300	980	648	392	48 000	4 540	384 000	830	10 600	2.5	21.8	
EB63-400	400	1 260	828	492	64 000	6 050	512 000	600	11 100	2	25.8	
EB63-500	500	1 540	1 008	592	80 000	7 560	640 000	670	12 000	1.5	29.8	

¹ The correct effective weight range for your application will be calculated by ACE and should fall within this band.

Special options: Special oils, special flanges, additional corrosion protection etc. available on request.

Front Flange -F

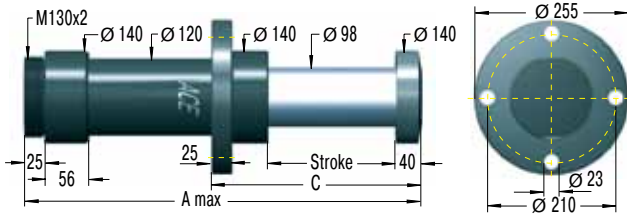

Rear Flange -R

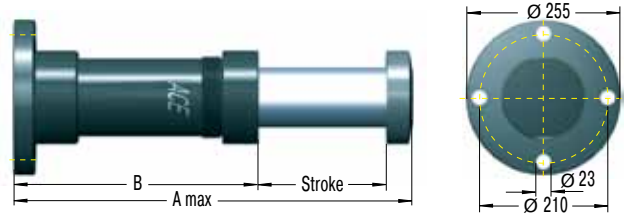

Ordering Example

Safety Shock Absorber _____
 Bore Size Ø 100 mm _____
 Stroke 400 mm _____
 Mounting Style: Front Flange _____
 Identification No. assigned by ACE _____

EB100-400-F-X

Please indicate identification no. in case of replacement order

Complete Details Required when Ordering

Moving load m (kg)
 Impact velocity range v (m/s)max.
 Creep speed vs (m/s)
 Motor power P (kW)
 Stall torque factor ST (normal 2.5)
 Number of absorbers in parallel n

or technical data according to formulae and calculations on page 13 to 15.

The calculation and selection of the correct ACE safety shock absorber for your application should be referred to ACE for approval and assignment of unique identification number.

Technical Data

Reacting force Q: At max. capacity rating = **467 kN max.**

Rod return: Nitrogen accumulator (0.55 bar to 1.03 bar) combined with return spring

Dimensions and Capacity Chart

Type	Stroke mm	A max	B	C	Max. Energy Capacity		1 Effective Weight me		Min. Return Force N	Max. Return Force N	Max. Side Load Angle °	Weight kg
					W ₃ Nm/Cycle	me min. kg	me max. kg					
EB100-200	200	735	495	320	80 000	7 560	640 000	1 200	8 900	4	42.5	
EB100-300	300	1 005	665	420	120 000	11 340	960 000	950	14 100	3.5	50.8	
EB100-400	400	1 275	835	520	160 000	15 120	1 280 000	1 190	18 200	3	59.1	
EB100-500	500	1 545	1 005	620	200 000	18 900	1 600 000	930	20 800	2.5	68.5	
EB100-600	600	1 815	1 175	720	240 000	22 680	1 920 000	1 170	23 300	2	76.8	

¹ The correct effective weight range for your application will be calculated by ACE and should fall within this band.

Special options: Special oils, special flanges, additional corrosion protection etc. available on request.

Front Flange -F

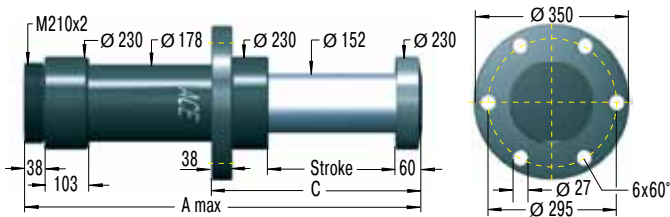

Rear Flange -R

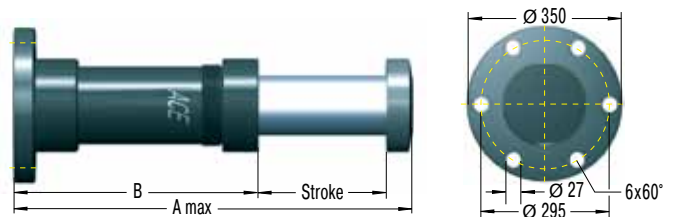

Ordering Example

Safety Shock Absorber _____
 Bore Size Ø 160 mm _____
 Stroke 400 mm _____
 Mounting Style: Front Flange _____
 Identification No. assigned by ACE _____

EB160-400-F-X

Please indicate identification no. in case of replacement order

Complete Details Required when Ordering

Moving load _____ m (kg)
 Impact velocity range _____ v (m/s)max.
 Creep speed _____ vs (m/s)
 Motor power _____ P (kW)
 Stall torque factor _____ ST (normal 2.5)
 Number of absorbers in parallel _____ n

or technical data according to formulae and calculations on page 13 to 15.

The calculation and selection of the correct ACE safety shock absorber for your application should be referred to ACE for approval and assignment of unique identification number.

Technical Data

Reacting force Q: At max. capacity rating = **700 kN max.**

Rod return: Nitrogen accumulator (0.55 bar to 1.03 bar) combined with return spring

Dimensions and Capacity Chart

Type	Stroke mm	A max	B	C	Max. Energy Capacity W ₃ Nm/Cycle	1 Effective Weight me		Min. Return Force N	Max. Return Force N	Max. Side Load Angle °	Weight kg
						me min. kg	me max. kg				
EB160-400	400	1 400	940	600	240 000	22 700	1 920 000	1 870	18 100	4	155.6
EB160-600	600	2 000	1 340	800	360 000	34 000	2 880 000	2 100	18 800	3	189
EB160-800	800	2 600	1 740	1 000	480 000	45 400	3 840 000	2 400	19 500	2	222.3

¹ The correct effective weight range for your application will be calculated by ACE and should fall within this band.

Special options: Special oils, special flanges, additional corrosion protection etc. available on request.

Permitted Use

ACE safety shock absorbers are machine elements to brake moving masses in a defined end position in emergency stop situations for axial forces. The safety shock absorbers are not designed for regular operational usage.

Calculation of safety shock absorbers

The calculation of safety shock absorbers should generally be performed or checked by ACE.

Deceleration Properties

The orifice sizing and drill pattern in the pressure chamber are individually designed for each safety shock absorber. The respective absorption characteristic is optimised corresponding to the maximum mass that occurs in the emergency stop and the impact speed. Correspondingly, each safety shock absorber is given an individual identification number.

Model Code

For types SCS33 to 64, the individual five-digit identification numbers can be taken from the last digits of the shock absorber model code shown on the label. Example: SCS33-50-1XXXX. For type series SCS38 to SCS63, CB63 to CB160 and EB63 to EB160, the identification number is a five digit number. Example: SCS38-100-F-XXXXX. In addition to the model code, the label also shows the authorised maximum impact velocity and maximum authorised impact mass for the unit.

Mounting

To mount the shock absorber, we recommend the use of original ACE mounting accessories shown in catalogue. The mounting of each shock absorber must be exactly positioned so that the reaction force (Q) can be adequately transmitted into the mounting structure. ACE recommends installation via the front flange -F mounting style that ensures the maximum protection against buckling. The damper must be mounted so that the moving loads are decelerated with the least possible side loading to the piston rod. The maximum permissible side load angles are detailed in our current catalogue. The entire stroke length must be used for deceleration because only using part of the stroke can lead to overstressing and damage to the unit.

Mounting style front flange -F



Safety Shock Absorber SCS

Safety Shock Absorber CB

Environmental Requirements

The permissible temperature range for each shock absorber type can be found in our current catalogue.

CAUTION: Usage outside the specified temperature range can lead to premature breakdown and damage of the shock absorbers which can then result in severe system damage or machine failures.

Trouble free operation outdoors or in damp environments is only warranted if the dampers are coated with a specific corrosion protection finish.

Initial Start-Up Checks

First impacts on the shock absorber should only be tried after correctly mounting and with reduced impact speeds and – if possible – with reduced load. Differences between calculated and actual operating data can then be detected early on, and damage to your system can be avoided. If the shock absorbers were selected on calculated data that does not correspond to the maximum possible loading (i.e. selection based on drive power being switched off or at reduced impact speed) then these restricted impact conditions must not be exceeded during initial testing or subsequent use of the system. Otherwise you risk damaging the shock absorbers and/or your machine by overstressing materials. After the initial trial check that the piston rod fully extends again and that there are no signs of oil leakage. Also check that the mounting hardware is still securely tightened. You need to satisfy yourself that no damage has occurred to the piston rod, the body, or the mounting hardware.

Fixed Mechanical Stop

Safety shock absorbers do not need an external stop as a stroke limiter. The stroke of the safety absorber is limited by the stop of the impact head on the shock absorber. For types SCS33 to SCS64, the fixed stop point is achieved with the integrated stop collar.

What Needs to be Checked after a Full Load Impact?

Safety shock absorbers that were originally checked only at reduced speed or load need to be checked again after a full load impact (i.e. emergency use) has occurred. Check that the piston rod fully extends to its full out position, that there are no signs of oil leakage and that the mounting hardware is still securely fixed. You need to satisfy yourself that no damage has occurred to the piston rod, the body, or the mounting hardware. If no damage has occurred, the safety shock absorber can be put back into normal operation (see **initial start-up**).

Maintenance

Safety shock absorbers are sealed systems and do not need special maintenance. Safety shock absorbers that are not used regularly (i.e. that are intended for emergency stop systems) should be checked within the normal time frame for safety checks, but **at least once a year**. At this time special attention must be paid to checking that the piston rod resets to its fully extended position, that there is no oil leakage and that the mounting brackets are still secure and undamaged. The piston rod must not show any signs of damage. Safety shock absorbers that are **in use regularly** should be checked **every three months**.

Repair Notice

If any damage to the shock absorber is detected or if there are any doubts as to the proper functioning of the unit please send the unit for service to ACE. Alternatively contact your local ACE office for further advice.

Detailed information on the above listed points can be taken from the corresponding operating and assembly instructions.

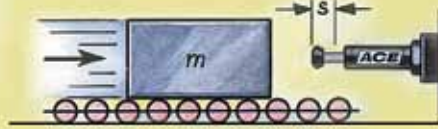

Controlled emergency stop

ACE safety shock absorbers protect precision assembly jigs for the aircraft industry.

The basic mount of this coordinate measuring machine for the production of parts in the aircraft industry is made of granite and must not be damaged. To avoid damage from operating errors or mishandling, all movement axes were equipped with safety shock absorbers of the type **SCS45-50**.

If the turntables malfunction the safety shock absorbers decelerate the loads before expensive damage can occur to the granite measuring tables.



Optimally protected turntable

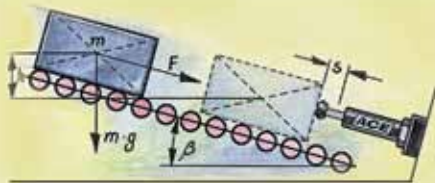

Downhill security

ACE safety shock absorbers defy the forces of nature.

In order to efficiently protect against falling rocks, a net is put through its paces under realistic conditions. Large sized **SCS80-500-F** type safety shock absorbers with additional crash sleeves safeguard the high durability of the test construction. These models provide the necessary reserves for energy absorption – especially with regard to the supporting forces which must be considered during the very high collision speed imposed on a stone transportation car.



Complete protection on a test facility

The **profile damper type TA** from the innovative ACE TUBUS series is a maintenance-free, self-contained damping element made from a special Co-Polyester Elastomer. As a result of the degressive damping characteristic it provides a high energy absorption at the beginning of its stroke. The excellent temperature characteristic of the material provides consistent damping performance over a temperature of -40 °C to 90 °C. The low installed weight, the economic price and the long operating life of up to 1 million cycles make this an attractive alternative to hydraulic end position damping, if the moving mass does not have to stop in an exact datum position and it is not necessary to absorb 100 % of the incoming energy. The **space-saving package size** ranges from Ø 12 mm up to Ø 116 mm and is very simply and quickly installed with the supplied specially stepped mounting screw. The TA series have been specially developed to provide **maximum energy capacity** in the **minimum mounting space** in the capacity range from 2 Nm up to 2951 Nm.

Life expectancy is extremely high; **up to twenty times** longer than for urethane dampers, **up to ten times** longer than rubber bumpers and **up to five times** longer than steel springs.

Calculation and selection to be approved by ACE. For applications with preloading and increased temperatures please consult ACE.

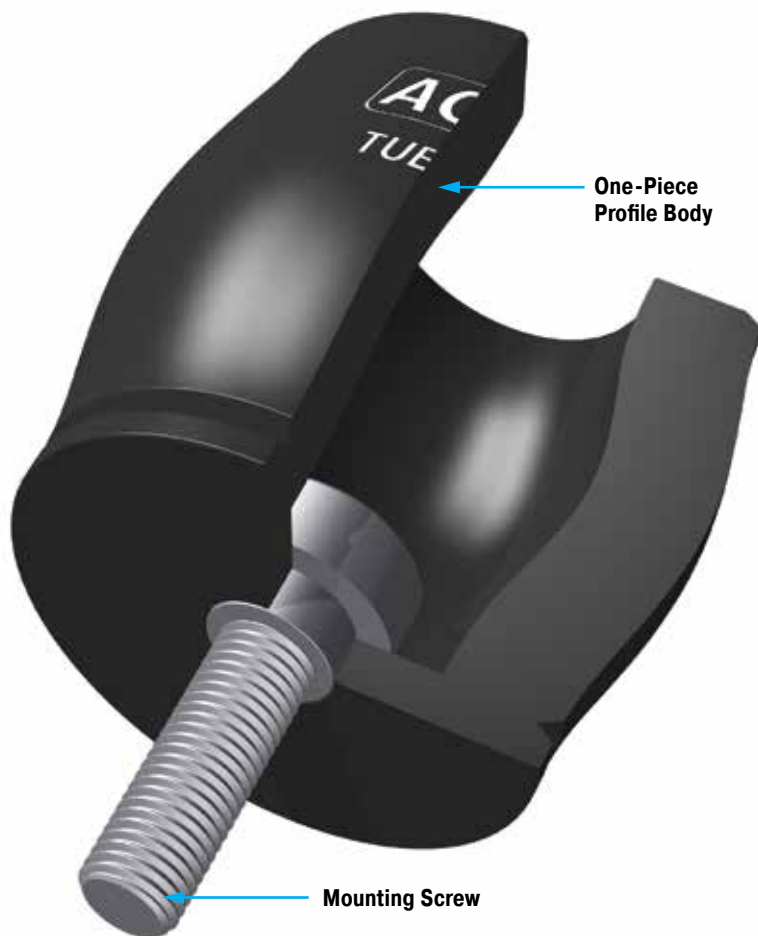

Impact velocity range: Up to max. 5 m/s

Environment: Resistant to oil, grease, seawater and to microbe or chemical attack. Excellent UV and ozone resistance. Material does not absorb water or swell.

Mounting: In any position

Dynamic force range: 870 N to 90 000 N

Operating temperature range: -40 °C to 90 °C

Energy absorption: 58 % to 73 %

Material hardness rating: Shore 55D

Max. torque:

M3:	1	Nm
M4:	1.7	Nm
M5:	2.3	Nm (DIN912)
	6	Nm (Shouldered screw)
M6:	10	Nm
M8:	20	Nm
M12:	50	Nm
M16:	120	Nm

Note: Mounting screw should additionally be secured with Loctite.

On request: Special strokes, -characteristics, -spring rates, -sizes and -materials.



Ordering Example

TUBUS Axial _____ **TA37-16**
 Outer-Ø 37 mm _____
 Stroke 16 mm _____

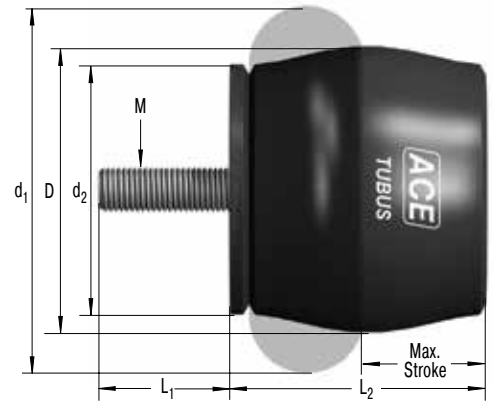

The calculation and selection of the required profile damper should be carried out or be approved by ACE.

Characteristics of Type TA37-16

Energy-Stroke Characteristic (dynamic)
 (with impact velocity over 0.5 m/s)

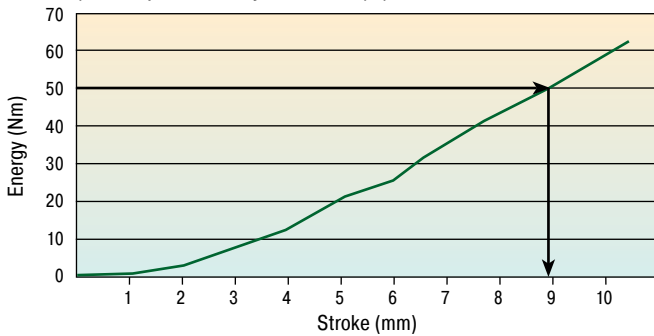

Force-Stroke Characteristic (dynamic)
 (with impact velocity over 0.5 m/s)

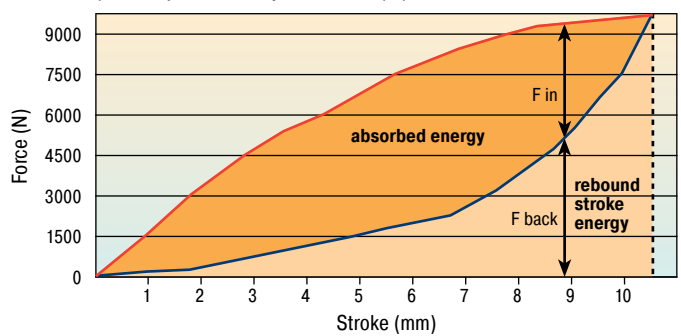

With the aid of the characteristic curves above you can estimate the proportion of the total energy that will be absorbed.
 Example: With impact energy of 50 Nm the Energy-Stroke diagram shows that a stroke of about 8.8 mm is needed.
 On the Force-Stroke diagram you can estimate the proportion of absorbed energy to rebound energy at this stroke length.

Dynamic ($v > 0.5$ m/s) and static ($v \leq 0.5$ m/s) characteristics of all types are available on request.

Dimensions and Capacity Chart

Type	¹ W ₃		Max. Stroke mm	D	L ₁	M	L ₂	d ₁	d ₂	Weight kg
	Nm/Cycle	Nm/Cycle								
TA12-5	2	3	5	12	3	M3	11	15	11	0.001
TA17-7	6	9	7	17	4	M4	16	22	15	0.004
TA21-9	10	16	9	21	5	M5	18	26	18	0.007
TA22-10	11.5	21	10	22	6	M6	19	27	19	0.008
TA28-12	29	46	12	28	6	M6	26	36	25	0.016
TA34-14	48	87	14	34	6	M6	30	43	30	0.024
TA37-16	65	112	16	37	6	M6	33	48	33	0.031
TA40-16	82	130	16	40	8	M8	35	50	34	0.04
TA43-18	112	165	18	43	8	M8	38	55	38	0.051
TA47-20	140	173	20	47	12	M12	41	60	41	0.08
TA50-22	170	223	22	50	12	M12	45	64	44	0.085
TA54-22	201	334	22	54	12	M12	47	68	47	0.1
TA57-24	242	302	24	57	12	M12	51	73	50	0.116
TA62-25	304	361	25	62	12	M12	54	78	53	0.132
TA65-27	374	468	27	65	12	M12	58	82	57	0.153
TA70-29	421	524	29	70	12	M12	61	86	60	0.174
TA72-31	482	559	31	72	16	M16	65	91	63	0.257
TA80-32	570	831	32	80	16	M16	69	100	69	0.312
TA82-35	683	921	35	82	16	M16	74	105	72	0.351
TA85-36	797	1 043	36	85	16	M16	76	110	75	0.391
TA90-38	934	1 249	38	90	16	M16	80	114	78	0.414
TA98-40	1 147	1 555	40	98	16	M16	86	123	85	0.513
TA116-48	2 014	2 951	48	116	16	M16	101	146	98	0.803

¹ Max. energy capacity per cycle for continuous use.
² Energy capacity per cycle for emergency use.

The **profile damper type TS** from the innovative ACE TUBUS series is a maintenance-free, self-contained damping element made from a special Co-Polyester Elastomer. As a result of the almost linear damping characteristic it provides a very smooth energy absorption with minimum reaction loads on the machine. The excellent temperature characteristic of the material provides consistent damping performance over a temperature of -40 °C to 90 °C. The low installed weight, the economic price and the long operating life of up to 1 million cycles make this an attractive alternative to hydraulic end position damping, if the moving mass does not have to stop in an exact datum position and it is not necessary to absorb 100 % of the incoming energy. The **space saving package size** ranges from Ø 14 mm up to Ø 107 mm and is very simply and quickly installed with the supplied specially stepped mounting screw. The TS series have been specially developed to provide **maximum energy capacity** in the **minimum mounting space** in the capacity range from 2 Nm up to 966 Nm.

Life expectancy is extremely high; **up to twenty times** longer than for urethane dampers, up to **ten times** longer than rubber bumpers and up to **five times** longer than steel springs.

Calculation and selection to be approved by ACE. For applications with preloading and increased temperatures please consult ACE.



Impact velocity range: Up to max. 5 m/s

Environment: Resistant to oil, grease, seawater and to microbe or chemical attack. Excellent UV and ozone resistance. Material does not absorb water or swell.

Mounting: In any position

Dynamic force range: 533 N to 23 500 N

Operating temperature range: -40 °C to 90 °C

Energy absorption: 35 % to 64 %

Material hardness rating:

Shore 40D

Max. torque:

M4: 1.7 Nm

M5: 2.3 Nm (DIN912)

6 Nm (Shouldered screw)

M6: 10 Nm

M12: 50 Nm

M16: 120 Nm

Note: Mounting screw should additionally be secured with Loctite.

On request: Special strokes, -characteristics, -spring rates, -sizes and -materials.



Ordering Example

TUBUS Axial Soft _____ **TS44-23**
 Outer-Ø 44 mm _____
 Stroke 23 mm _____

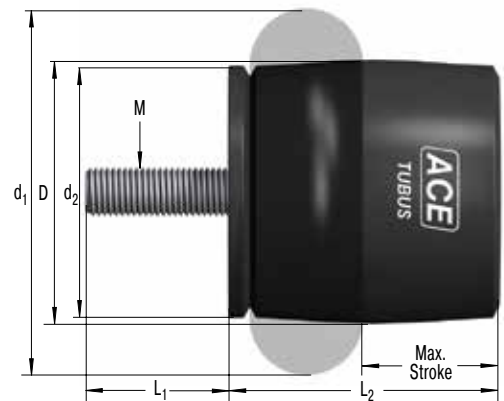

The calculation and selection of the required profile damper should be carried out or be approved by ACE.

Characteristics of Type TS44-23

Energy-Stroke Characteristic (dynamic)
 (with impact velocity over 0.5 m/s)

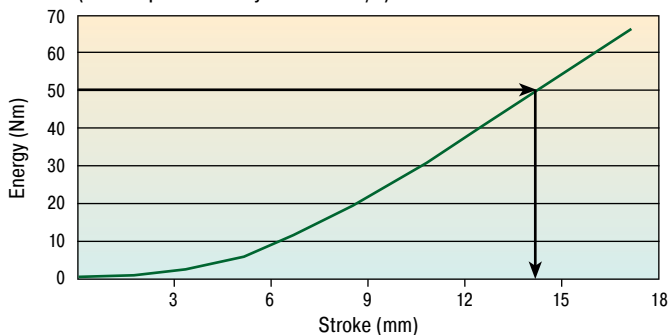

Force-Stroke Characteristic (dynamic)
 (with impact velocity over 0.5 m/s)

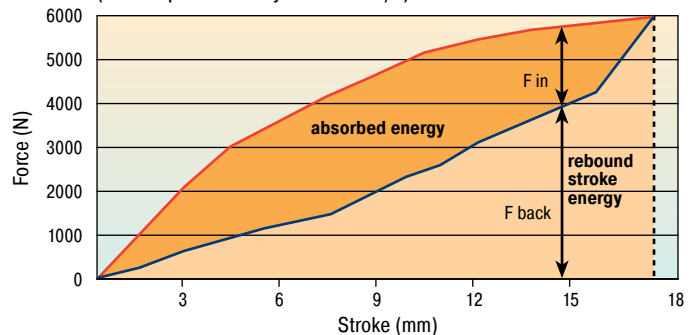

With the aid of the characteristic curves above you can estimate the proportion of the total energy that will be absorbed.
 Example: With impact energy of 50 Nm the Energy-Stroke diagram shows that a stroke of about 14 mm is needed.
 On the Force-Stroke diagram you can estimate the proportion of absorbed energy to rebound energy at this stroke length.

Dynamic ($v > 0.5$ m/s) and static ($v \leq 0.5$ m/s) characteristics of all types are available on request.

Dimensions and Capacity Chart

Type	¹ W ₃		Max. Stroke mm	D	L ₁	M	L ₂	d ₁	d ₂	Weight kg
	Nm/Cycle	Nm/Cycle								
TS14-7	2	3	7	14	4	M4	15	19	13	0.003
TS18-9	4	6	9	18	5	M5	18	24	16	0.006
TS20-10	6	7	10	20	6	M6	21	27	19	0.008
TS26-15	11.5	15	15	26	6	M6	28	37	25	0.015
TS32-16	23	26	16	32	6	M6	32	44	30	0.021
TS35-19	30	36	19	35	6	M6	36	48	33	0.028
TS40-19	34	42	19	40	6	M6	38	51	34	0.031
TS41-21	48	63	21	41	12	M12	41	55	38	0.051
TS44-23	63	72	23	44	12	M12	45	60	40	0.072
TS48-25	81	91	25	48	12	M12	49	64	44	0.086
TS51-27	92	114	27	51	12	M12	52	69	47	0.102
TS54-29	122	158	29	54	12	M12	55	73	50	0.116
TS58-30	149	154	30	58	12	M12	59	78	53	0.132
TS61-32	163	169	32	61	16	M16	62	83	56	0.203
TS64-34	208	254	34	64	16	M16	66	87	60	0.233
TS68-36	227	272	36	68	16	M16	69	92	63	0.248
TS75-39	291	408	39	75	16	M16	75	101	69	0.301
TS78-40	352	459	40	78	16	M16	79	105	72	0.339
TS82-44	419	620	44	82	16	M16	84	110	75	0.346
TS84-43	475	635	43	84	16	M16	85	115	78	0.402
TS90-47	580	778	47	90	16	M16	92	124	84	0.49
TS107-56	902	966	56	107	16	M16	110	147	100	0.733

¹ Max. energy capacity per cycle for continuous use.

² Energy capacity per cycle for emergency use.

The **profile damper type TR** from the innovative ACE TUBUS series is a maintenance-free, self-contained damping element made from a special Co-Polyester Elastomer. The radial deformation of the TR series provides a very long and soft deceleration with a progressive energy absorption towards the end of stroke. The excellent temperature characteristic of the material provides consistent damping performance over a temperature of -40 °C to 90 °C. The low installed weight, the economic price and the long operating life of up to 1 million cycles make this an attractive alternative to hydraulic end position damping, if the moving mass does not have to stop in an exact datum position and it is not necessary to absorb 100 % of the incoming energy. The **space saving package size** ranges from Ø 29 mm up to Ø 100 mm and is very simply and quickly installed with the supplied special stepped mounting screw. The TR series have been specially developed to provide **maximum stroke** in the **minimum mounting space** in the capacity range from 1.2 Nm up to 146 Nm.

Life expectancy is extremely high; **up to twenty times** longer than for urethane dampers, **up to ten times longer** than rubber bumpers and **up to five times** longer than steel springs.

Calculation and selection to be approved by ACE. For applications with preloading and increased temperatures please consult ACE.



Impact velocity range: Up to max. 5 m/s

Environment: Resistant to oil, grease, seawater and to microbe or chemical attack. Excellent UV and ozone resistance. Material does not absorb water or swell.

Mounting: In any position

Dynamic force range: 218 N to 7500 N

Operating temperature range:
-40 °C to 90 °C

Energy absorption: 25 % to 45 %

Material hardness rating:
Shore 40D

Max. torque:

M5: 6 Nm

M6: 10 Nm

M8: 20 Nm

Note: Mounting screw should additionally be secured with Loctite.

On request: Special strokes, -characteristics, -spring rates, -sizes and -materials.



Ordering Example

TUBUS Radial _____ ↑ ↑ ↑
 Outer-Ø 93 mm _____ ↑ ↑ ↑
 Stroke 57 mm _____ ↑ ↑ ↑

TR93-57

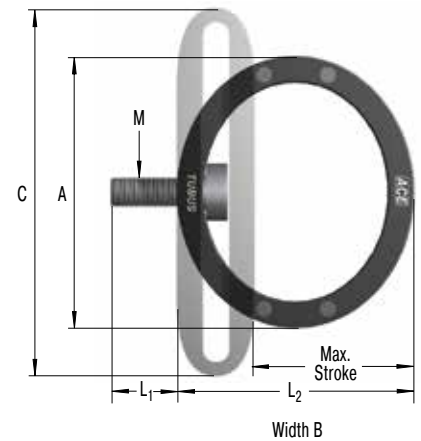

The calculation and selection of the required profile damper should be carried out or be approved by ACE.

Characteristics of Type TR93-57

Energy-Stroke Characteristic (dynamic)
 (with impact velocity over 0.5 m/s)

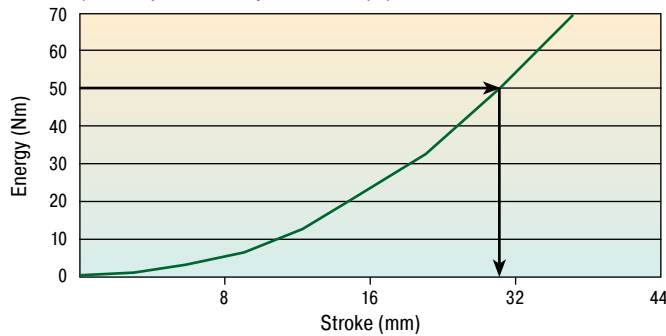

Force-Stroke Characteristic (dynamic)
 (with impact velocity over 0.5 m/s)

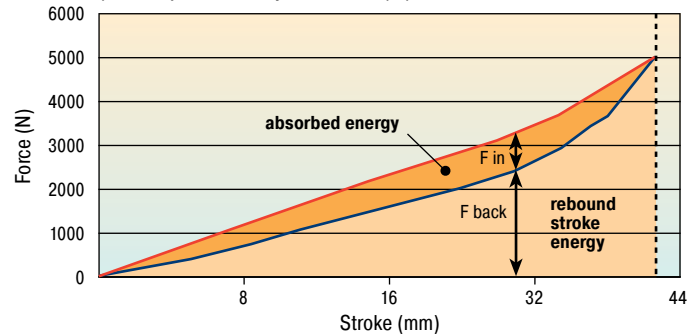

With the aid of the characteristic curves above you can estimate the proportion of the total energy that will be absorbed.
 Example: With impact energy of 50 Nm the Energy-Stroke diagram shows that a stroke of about 31 mm is needed.
 On the Force-Stroke diagram you can estimate the proportion of absorbed energy to rebound energy at this stroke length.

Dynamic ($v > 0.5$ m/s) and static ($v \leq 0.5$ m/s) characteristics of all types are available on request.

Dimensions and Capacity Chart

Type	¹ W ₃		Max. Stroke mm	A	L ₁	M	L ₂	B	C	Weight kg
	Nm/Cycle	Nm/Cycle								
TR29-17	1.2	1.8	17	29	5	M5	25	13	38	0.006
TR37-22	2.3	5.4	22	37	5	M5	32	19	50	0.013
TR43-25	3.5	8.1	25	43	5	M5	37	20	58	0.017
TR50-35	5.8	8.3	35	50	5	M5	44	34	68	0.026
TR63-43	12	17	43	63	5	M5	55	43	87	0.051
TR67-40	23	33	40	67	5	M5	59	46	88	0.077
TR76-46	34.5	43	46	76	6	M6	67	46	102	0.104
TR83-50	45	74	50	83	6	M6	73	51	109	0.142
TR85-50	68	92	50	85	8	M8	73	68	111	0.206
TR93-57	92	122	57	93	8	M8	83	83	124	0.297
TR100-60	115	146	60	100	8	M8	88	82	133	0.335

¹ Max. energy capacity per cycle for continuous use.

² Energy capacity per cycle for emergency use.

Like the standard model TR, the **profile damper type TR-H** is used for radial damping and therefore provides a very long and soft deceleration. The profile dampers from the innovative ACE TUBUS series are maintenance-free, self-contained damping elements made from a special Co-Polyester Elastomer. With nearly the same dimensions the TUBUS TR-H type provides a much higher energy absorption due to a harder mixture of materials. The TR-H type completes the TUBUS series between the progressive model type TR and the almost linear type TS. This offers an individual and widely graduated range of damping characteristics within the whole TUBUS series. The excellent temperature characteristic of the material provides consistent damping performance over a temperature of -40 °C to 90 °C. The low installed weight, the economic price and the long operating life of up to 1 million cycles make this an attractive alternative to hydraulic end position damping, if the moving mass does not have to stop in an exact datum position and it is not necessary to absorb 100 % of the incoming energy. The **space saving package size** ranges from Ø 30 mm up to Ø 102 mm and is very simply and quickly installed with the supplied special stepped mounting screw. The TR-H series have been specially developed to provide **maximum stroke** in the **minimum mounting space** in the capacity range from 2.7 Nm up to 427 Nm.

Life expectancy is extremely high; **up to twenty times** longer than for urethane dampers, **up to ten times** longer than rubber bumpers and **up to five times** longer than steel springs.

Calculation and selection to be approved by ACE. For applications with preloading and increased temperatures please consult ACE.



Impact velocity range: Up to max. 5 m/s

Environment: Resistant to oil, grease, seawater and to microbe or chemical attack. Excellent UV and ozone resistance. Material does not absorb water or swell.

Mounting: In any position

Dynamic force range: 550 N to 21 200 N

Operating temperature range:
-40 °C to 90 °C

Energy absorption: 39 % to 62 %

Material hardness rating:
Shore 55D

Max. torque:
M5: 6 Nm
M6: 10 Nm
M8: 20 Nm

Note: Mounting screw should additionally be secured with Loctite.

On request: Special strokes, -characteristics, -spring rates, -sizes and -materials.



Ordering Example

TUBUS Radial _____ ↑ ↑ ↑
 Outer-Ø 95 mm _____ ↑ ↑ ↑
 Stroke 50 mm _____ ↑ ↑ ↑
 Hard Version _____ ↑ ↑ ↑

TR95-50H

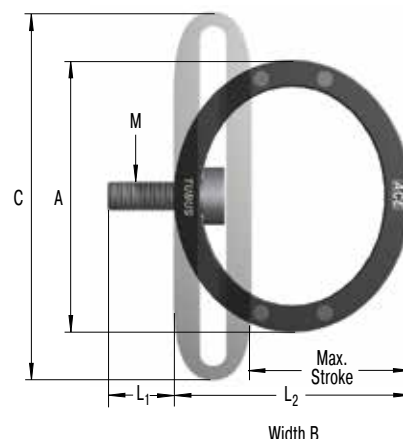

The calculation and selection of the required profile damper should be carried out or be approved by ACE.

Characteristics of Type TR95-50H

Energy-Stroke Characteristic (dynamic)
 (with impact velocity over 0.5 m/s)

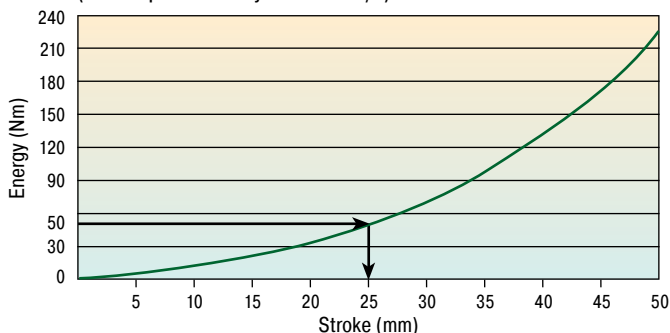

Force-Stroke Characteristic (dynamic)
 (with impact velocity over 0.5 m/s)

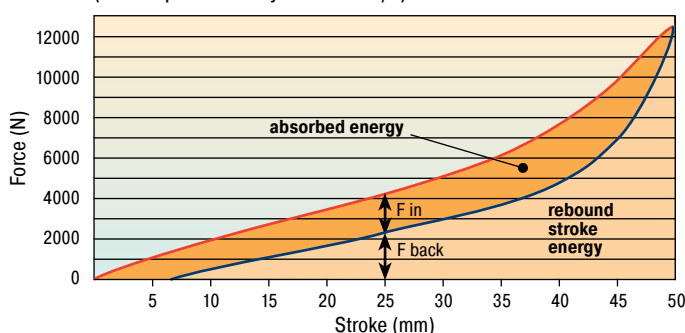

With the aid of the characteristic curves above you can estimate the proportion of the total energy that will be absorbed.
 Example: With impact energy of 50 Nm the Energy-Stroke diagram shows that a stroke of about 25 mm is needed.
 On the Force-Stroke diagram you can estimate the proportion of absorbed energy to rebound energy at this stroke length.

Dynamic ($v > 0.5$ m/s) and static ($v \leq 0.5$ m/s) characteristics of all types are available on request.

Dimensions and Capacity Chart

Type	¹ W ₃	² W ₃	Max. Stroke mm	A	L ₁	M	L ₂	B	C	Weight kg
	Nm/Cycle	Nm/Cycle								
TR30-15H	2.7	5.7	15	30	5	M5	23	13	38	0.004
TR39-19H	6	18	19	39	5	M5	30	19	50	0.011
TR45-23H	8.7	24	23	45	5	M5	36	20	58	0.016
TR52-32H	11.7	20	32	52	5	M5	42	34	68	0.025
TR64-41H	25	46	41	64	5	M5	53	43	87	0.051
TR68-37H	66.5	98	37	68	5	M5	56	46	88	0.080
TR79-42H	81.5	106	42	79	6	M6	64	46	102	0.105
TR86-45H	124	206	45	86	6	M6	69	51	109	0.146
TR87-46H	158	261	46	86	8	M8	68	67	111	0.190
TR95-50H	228	342	50	95	8	M8	77	82	124	0.266
TR102-56H	290	427	56	102	8	M8	84	81	133	0.319

¹ Max. energy capacity per cycle for continuous use.

² Energy capacity per cycle for emergency use.

The **radial tube damper type TR-L** from the innovative ACE TUBUS series is a maintenance-free, self-contained damping element made from a special Co-Polyester Elastomer. The radial deformation of the TR series provides a very long and soft deceleration with a progressive energy absorption towards the end of stroke. The excellent temperature characteristic of the material provides consistent damping performance over a temperature of -40 °C to 90 °C. The tube damper has been specially developed for applications that require very low reaction forces. The actual force generated depends upon the length of the tube damper chosen. The TUBUS TR-L type is suitable for a wide range of applications that require protection from shock or impact anywhere along a straight line. Typical applications include mining equipment, dockyard handling equipment and on baggage handling and conveyor systems. The TR-L series have been developed to provide **maximum stroke** in the **minimum mounting space** in the capacity range from 7.2 Nm up to 10 780 Nm.

Life expectancy is extremely high; **up to twenty times** longer than for urethane dampers, up to **ten times** longer than rubber bumpers and up to **five times** longer than steel springs.

Calculation and selection to be approved by ACE. For applications with preloading and increased temperatures please consult ACE.



Impact velocity range: Up to max. 5 m/s

Environment: Resistant to oil, grease, seawater and to microbe or chemical attack. Excellent UV and ozone resistance. Material does not absorb water or swell.

Capacity rating: For emergency use only (1 cycle) it is possible to exceed the W_3 rating by +40 %.

Mounting: In any position

Dynamic force range: 1312 N to 217 700 N

Operating temperature range:
-40 °C to 90 °C

Energy absorption: 26 % to 41 %

Material hardness rating:
Shore 40D

Max. torque:

M5: 6 Nm

M8: 20 Nm

M16: 40 Nm (DIN912)

120 Nm (Shouldered screw)

Note: Mounting screw should additionally be secured with Loctite.

On request: Special strokes, -colours, -sizes and -materials.



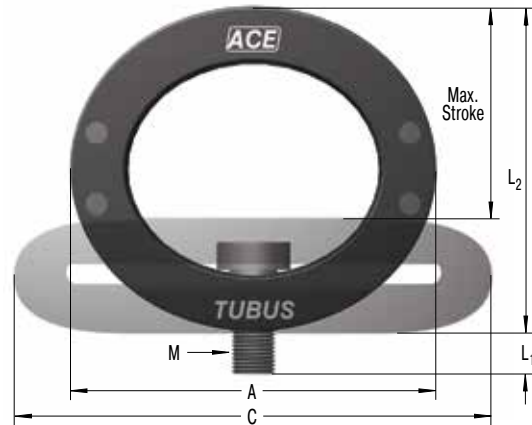
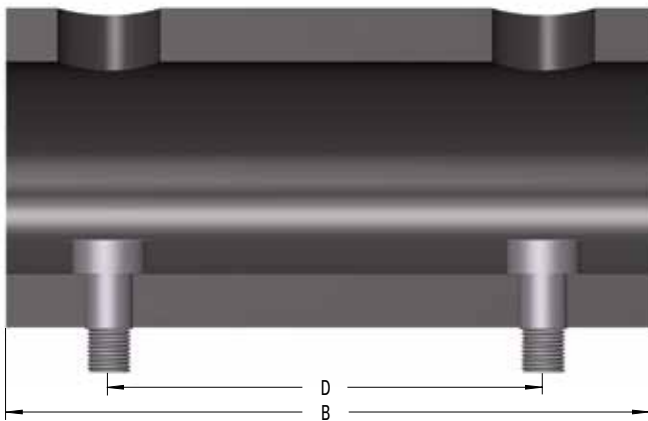

Ordering Example

TUBUS Radial _____ **TR66-40L-2**
 Outer-Ø 66 mm _____
 Stroke 40 mm _____
 Long Version _____
 Length 2 = 305 mm _____

The calculation and selection of the required profile damper should be carried out or be approved by ACE.

Dimensions and Capacity Chart

Type	¹ W ₃ Nm/Cycle	² W ₃ Nm/Cycle	Max. Stroke mm	A	B	C	D	M	L ₁	L ₂	Weight kg
TR29-17L	7.2	10.9	17	29	80	38	40	M5	5	25	0.044
TR43-25L	14	32.7	25	43	80	58	40	M5	5	37	0.072
TR63-43L	21.9	32	43	63	80	87	40	M5	5	55	0.106
TR66-40L-1	102	143	40	66	152	87	102	M8	8	59	0.027
TR66-40L-2	204	286	40	66	305	87	254	M8	8	59	0.58
TR66-40L-3	306	428	40	66	457	87	406	M8	8	59	0.83
TR66-40L-4	408	571	40	66	610	87	559	M8	8	59	1.13
TR66-40L-5	510	714	40	66	762	87	711	M8	8	59	1.33
TR76-45L-1	145	203	45	76	152	100	102	M8	8	68	0.38
TR76-45L-2	290	406	45	76	305	100	254	M8	8	68	0.696
TR76-45L-3	435	609	45	76	457	100	406	M8	8	68	1.13
TR76-45L-4	580	812	45	76	610	100	559	M8	8	68	1.43
TR76-45L-5	725	1 015	45	76	762	100	711	M8	8	68	1.78
TR83-48L-1	180	252	48	83	152	106	102	M8	8	73	0.48
TR83-48L-2	360	504	48	83	305	106	254	M8	8	73	0.93
TR83-48L-3	540	756	48	83	457	106	406	M8	8	73	1.38
TR83-48L-4	720	1 008	48	83	610	106	559	M8	8	73	1.81
TR83-48L-5	900	1 260	48	83	762	106	711	M8	8	73	2.26
TR99-60L-1	270	378	60	99	152	130	102	M16	16	88	0.79
TR99-60L-2	540	756	60	99	305	130	254	M16	16	88	1.29
TR99-60L-3	810	1 134	60	99	457	130	406	M16	16	88	1.94
TR99-60L-4	1 080	1 512	60	99	610	130	559	M16	16	88	2.54
TR99-60L-5	1 350	1 890	60	99	762	130	711	M16	16	88	3.1
TR99-60L-6	1 620	2 268	60	99	914	130	864	M16	16	88	3.7
TR99-60L-7	1 890	2 646	60	99	1 067	130	1 016	M16	16	88	4.3
TR143-86L-1	600	840	86	143	152	191	76	M16	16	127	1.44
TR143-86L-2	1 200	1 680	86	143	305	191	203	M16	16	127	2.9
TR143-86L-3	1 800	2 520	86	143	457	191	355	M16	16	127	3.88
TR143-86L-4	2 400	3 360	86	143	610	191	508	M16	16	127	5.29
TR143-86L-5	3 000	4 200	86	143	762	191	660	M16	16	127	6.59
TR143-86L-6	3 600	5 040	86	143	914	191	812	M16	16	127	7.89
TR143-86L-7	4 200	5 880	86	143	1 067	191	965	M16	16	127	9.19
TR188-108L-1	1 100	1 540	108	188	152	245	76	M16	16	165	2.34
TR188-108L-2	2 200	3 080	108	188	305	245	203	M16	16	165	4.64
TR188-108L-3	3 300	4 620	108	188	457	245	355	M16	16	165	6.89
TR188-108L-4	4 400	6 160	108	188	610	245	508	M16	16	165	9.19
TR188-108L-5	5 500	7 700	108	188	762	245	660	M16	16	165	11.39
TR188-108L-6	6 600	9 240	108	188	914	245	812	M16	16	165	13.64
TR188-108L-7	7 700	10 780	108	188	1 067	245	965	M16	16	165	15.94

¹ Max. energy capacity per cycle for continuous use.

² Energy capacity per cycle for emergency use.

The **profile dampers TR-HD** from the innovative ACE TUBUS series are maintenance free, ready to install damper elements manufactured from a co-polyester elastomer. The TUBUS profile dampers are loaded radially just like the basic model TR. Compared to the basic model, however, their solid structural design offers a high level of power and energy absorption within a minimum damping distance. The two different material strengths allow different damping characteristics to be targeted. The slightly biconcave structure also ensures softer force run. The TUBUS TR-HD is suitable for all forms of use, which demand a high level of protection against impact or collision. The high level of power and energy absorption offers a wide range of application, amongst other in agricultural technology and for construction machines e. g. shovels or articulated joints of construction site vehicles. The relevant support power also depends on the material strength of the chosen shock absorber. The TR-HD series was specially developed to absorb a **maximum of energy with minimum construction height**. A stroke of 12 mm to 44 mm easily covers energy absorption within a range of between 230 Nm and 5208 Nm. The profile damper is simply and quickly mounted horizontally as well as vertically with the two supplied screws. The drill distance for fastening can be individually adjusted upon request.

Life expectancy is extremely high; **up to twenty times** longer than for urethane dampers, up to **ten times** longer than rubber bumpers and up to **five times** longer than steel springs.

Calculation and selection to be approved by ACE. For applications with preloading and increased temperatures please consult ACE.

NEW



"The latest high capacity version – for maximum force within a minimum damping distance!"



Impact velocity range: Up to max. 5 m/s

Environment: Resistant to oil, grease, seawater and to microbe or chemical attack. Excellent UV and ozone resistance. Material does not absorb water or swell.

Capacity rating: For emergency use only (1 cycle) it is possible to exceed the W_3 rating by +40 %.

Mounting: In any position

Dynamic force range: 78 800 N to 812 900 N

Operating temperature range: -40 °C to 90 °C

Energy absorption: 43 % to 72 %

Material hardness rating: Shore 40D, Shore 55D

Max. torque:
M10: 7 Nm
M12: 12 Nm

Note: Mounting screw should additionally be secured with Loctite.

On request: Special strokes, -characteristics, -spring rates, -sizes and -materials.



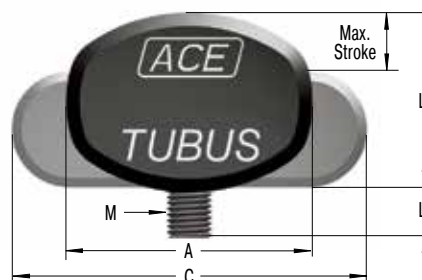
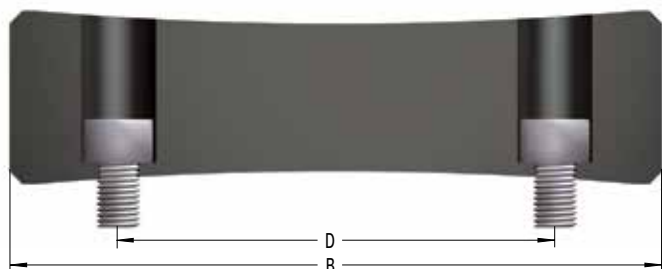

Ordering Example

TUBUS Radial _____ ↑ ↑ ↑
 Outer-Ø 63 mm _____ ↑ ↑ ↑
 Stroke 24 mm _____ ↑ ↑ ↑
 Heavy Duty Version _____ ↑ ↑ ↑

TR63-24HD

The calculation and selection of the required profile damper should be carried out or be approved by ACE.

Comparison of Damping Characteristics of Type TR-HD

Force-Stroke Characteristics (static)

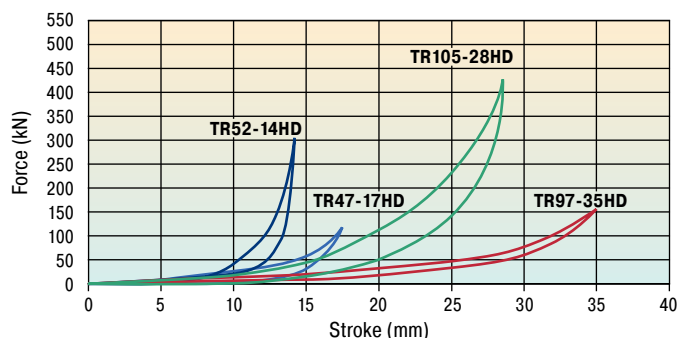

Dimensions and Capacity Chart

Type	¹ W ₃ Nm/Cycle	² W ₃ Nm/Cycle	F max. static N	Max. Stroke mm	A	B	C	D	M	L ₁	L ₂	Weight kg
TR42-14HD	405	567	63 900	14	42	148	59	102	M10	20	34	0.17
TR47-12HD	857	1 200	149 600	12	47	150	58	102	M10	19	31	0.17
TR47-17HD	850	1 190	122 100	17	47	150	70	102	M10	24	32	0.18
TR52-14HD	1 634	2 288	304 500	14	52	153	69	102	M10	22	29	0.18
TR57-21HD	1 194	1 672	104 800	21	57	149	79	102	M10	18	48	0.34
TR62-15HD	2 940	4 116	245 000	15	62	153	77	102	M10	16	40	0.33
TR62-19HD	2 940	4 116	389 900	19	62	152	94	102	M10	16	41	0.36
TR63-24HD	2 061	2 885	194 400	24	63	153	92	102	M10	20	46	0.33
TR72-26HD	1 700	2 380	124 800	26	72	149	98	102	M12	23	59	0.56
TR79-20HD	2 794	3 912	289 300	20	79	153	98	102	M12	24	54	0.57
TR79-31HD	2 975	4 165	226 600	31	79	155	112	102	M12	23	58	0.56
TR85-33HD	2 526	3 536	146 100	33	85	150	111	102	M12	23	71	0.71
TR89-21HD	4 438	6 213	477 400	21	89	162	112	102	M12	22	48	0.56
TR90-37HD	3 780	5 292	240 700	37	90	155	128	102	M12	23	69	0.75
TR93-24HD	3 421	4 789	302 500	24	93	155	115	102	M12	23	64	0.79
TR97-31HD	7 738	10 833	575 200	31	97	159	129	102	M12	21	63	0.8
TR97-35HD	2 821	3 949	152 800	35	97	151	131	102	M12	20	82	1.06
TR102-44HD	4 697	6 576	254 500	44	102	156	147	102	M12	22	81	1.05
TR105-28HD	5 641	7 897	427 600	28	105	156	126	102	M12	21	72	1
TR117-30HD	8 457	11 840	639 100	30	117	166	143	102	M12	25	66	1.01

¹ Max. energy capacity per cycle for continuous use.

² Energy capacity per cycle for emergency use.

The **profile damper type TC** from the innovative ACE TUBUS series is a maintenance-free, self-contained damping element made from a special Co-Polyester Elastomer. They have been specially developed for crane equipment applications and fulfill the international industry standards OSHA and CMAA. Many crane applications require a spring rate with a high return force. This is achieved with the unique **Dual-Profile Concept** of the **TC-S** models. For energy-management-systems the TC model types provide a cost efficient solution with a high return force capability. The very small and light package size from Ø 64 mm up to Ø 176 mm covers an energy absorption capacity ranging from 450 Nm up to 17 810 Nm/cycle. The excellent resistance to UV, seawater, chemical and microbe attack together with the wide operating temperature range from -40 °C to 90 °C enables a wide range of applications.

Life expectancy is extremely high; **up to twenty times** longer than for urethane dampers, **up to ten times** longer than rubber bumpers and **up to five times** longer than steel springs.

Calculation and selection to be approved by ACE. For applications with preloading and increased temperatures please consult ACE.



Impact velocity range: Up to max. 5 m/s

Environment: Resistant to oil, grease, seawater and to microbe or chemical attack. Excellent UV and ozone resistance. Material does not absorb water or swell.

Capacity rating: For emergency use only (1 cycle) it is possible to exceed the W_3 rating by +40 %.

Mounting: In any position

Dynamic force range: 80 000 N to 978 000 N

Operating temperature range:
-40 °C to 90 °C

Energy absorption: 31 % to 64 %

Material hardness rating:

Shore 55D

Max. torque:

M12: 50 Nm

M16: 40 Nm (DIN912)

120 Nm (Shouldered screw)

Note: Mounting screw should additionally be secured with Loctite.

On request: Special strokes, -characteristics, -spring rates, -sizes and -materials.

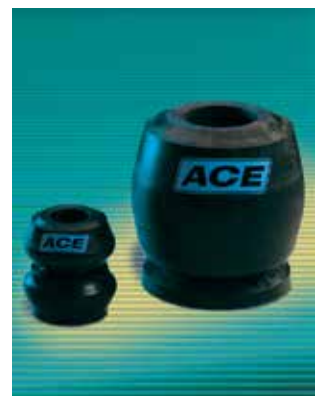

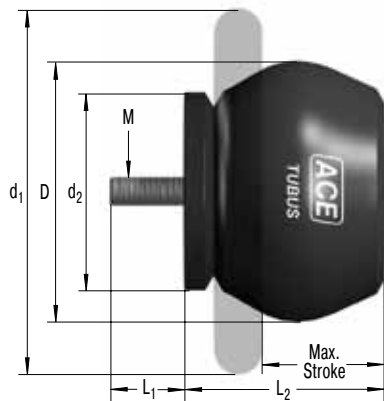

Model Type TC

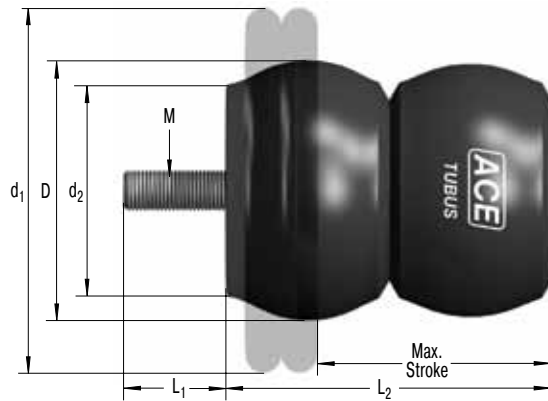

Model Type TC-S

Ordering Example

TUBUS Crane Buffer _____
 Outer-Ø 83 mm _____
 Stroke 73 mm _____
 Model Type Soft _____

TC83-73-S

The calculation and selection of the required profile damper should be carried out or be approved by ACE.

Characteristics of Type TC90-49

Energy-Stroke Characteristic (dynamic)
 (with impact velocity over 0.5 m/s)

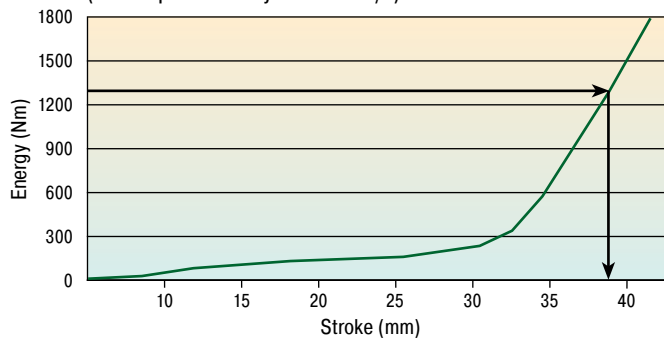

Force-Stroke Characteristic (dynamic)
 (with impact velocity over 0.5 m/s)

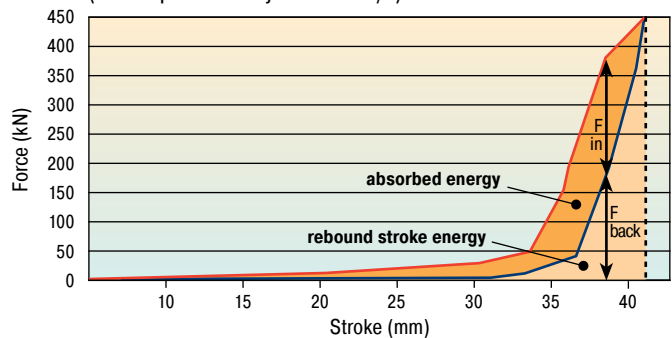

With the aid of the characteristic curves above you can estimate the proportion of the total energy that will be absorbed.

Example: With impact energy of 1300 Nm the Energy-Stroke diagram shows that a stroke of about 38 mm is needed.

On the Force-Stroke diagram you can estimate the proportion of absorbed energy to rebound energy at this stroke length.

Note: With these types the return force towards the end of the stroke is significant and we recommend you try to use a minimum of 90 % of the total stroke available.

Dynamic ($v > 0.5$ m/s) and static ($v \leq 0.5$ m/s) characteristics of all types are available on request.

Dimensions and Capacity Chart

Type	¹ W ₃ Nm/Cycle	² W ₃ Nm/Cycle	Max. Stroke mm	D	L ₁	M	L ₂	d ₁	d ₂	Weight kg
TC64-62-S	450	630	62	64	12	M12	79	89	52	0.175
TC74-76-S	980	1 372	76	74	12	M12	96	114	61	0.261
TC83-73-S	1 940	2 715	73	83	12	M12	94	127	69	0.328
TC86-39	1 210	1 695	39	86	12	M12	56	133	78	0.284
TC90-49	1 640	2 295	49	90	12	M12	68	124	67	0.265
TC100-59	1 785	2 500	59	100	12	M12	84	149	91	0.513
TC102-63	1 970	2 760	63	102	16	M16	98	140	82	0.633
TC108-30	1 900	2 660	30	108	12	M12	53	133	77	0.392
TC117-97	3 710	5 195	97	117	16	M16	129	188	100	1.053
TC134-146-S	7 310	10 230	146	134	16	M16	188	215	117	1.573
TC136-65	4 250	5 950	65	136	16	M16	106	178	106	1.173
TC137-90	6 350	8 890	90	137	16	M16	115	216	113	1.193
TC146-67-S	8 330	11 660	67	146	16	M16	118	191	99	1.573
TC150-178-S	8 860	12 400	178	150	16	M16	241	224	132	2.581
TC153-178-S	7 260	10 165	178	153	16	M16	226	241	131	2.493
TC168-124	10 100	14 140	124	168	16	M16	166	260	147	2.533
TC176-198-S	12 725	17 810	198	176	16	M16	252	279	150	3.685

¹ Max. energy capacity per cycle for continuous use.

² Energy capacity per cycle for emergency use.



"TUBUS profile dampers – ideal for use in agricultural machinery!"

TUBUS profile dampers give tele-wheel loaders strong stability. With their function of limiting swinging movement, they secure machines when cornering and loading and provide a high degree of comfort and safety as well as securing the loaders. A further advantage is that the shovel can be loaded up to its full capacity for better performance when levelling and pushing.

Small cost, large force absorption: The **TUBUS profile damper TC design series** employed here convinces with its energy absorption in the range of 450 Nm up to 12 725 Nm, whereby the machine elements with diameters of between 64 mm and 176 mm are very easily integrated into construction designs.



High level of stability and more driving comfort for tele-wheel loaders

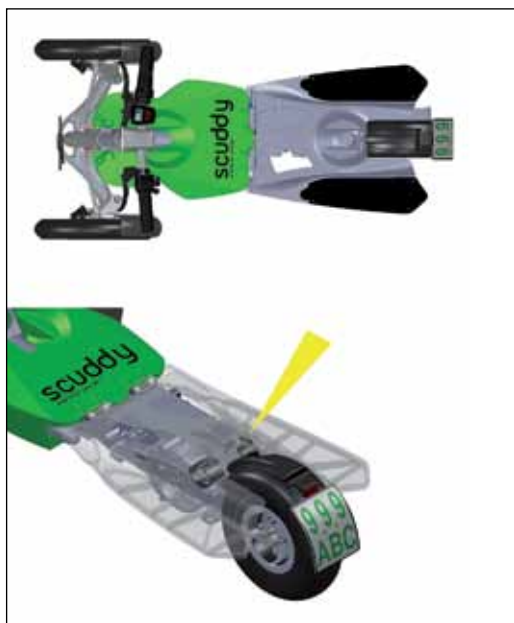

Compact, maintenance free, comfortable and also suitable for a load capacity of 100 kg: the tandem construction with **TR52-32H** type TUBUS profile dampers, which absorb up to 11.7 Nm/Cycle.

TUBUS profile dampers make driving an e-scooter a real experience.

The footboard of an electric scooter should be dampened to enable the driver to experience a comfortable ride even over pot-holes and other bumpy surfaces. Ideally, the characteristic line should be furnished with a soft increase in force over a long stroke. The elegant look of the scooter as well as the folding mechanism designed to save space have not allowed the use of feasible damper solutions up to now. Inferior alternatives such as rubber dampers made of polyurethane or simple steel springs could not be considered from the start. The TUBUS profile damper **TR52-32H** offered the perfect solution with its compact construction design paired with progressive damping action.



Profile dampers increase the riding comfort of an electric scooter

ACE presents its new damper family especially for pressing tools

Innovative damping solutions were developed to meet the requirements of ever increasing demands on damping. The stresses on machines and tool components, especially in the new press generation (servo presses) are increasing because of high pressing speeds.

ACE's new damping elements increase tool service life and efficiency.



Detailed information about down holder dampers, lift dampers, damping plugs and press dampers can be found on our web site www.ace-ace.com



- Long service life and operational safety
- High absorption of force and energy
- Reduction of noise
- Higher cycle times ensure efficient work
- High-level energy absorption
- High-level resistance to abrasion and shearing

The innovative, co-polyester elastomer **TUBUS down holder damper** has found a **new application as a damper for pressing tools** and replaces overloaded PU springs. Sheet metal forming takes place increasingly in the automobile and household goods industry because of faster presses. Retaining screws and therefore the actual tool are sustainably protected when the press is opened after the pressing process. The TUBUS-Special is available for different screws from M10 to M30. The maximum energy absorption is between 5 Nm and 269 Nm.

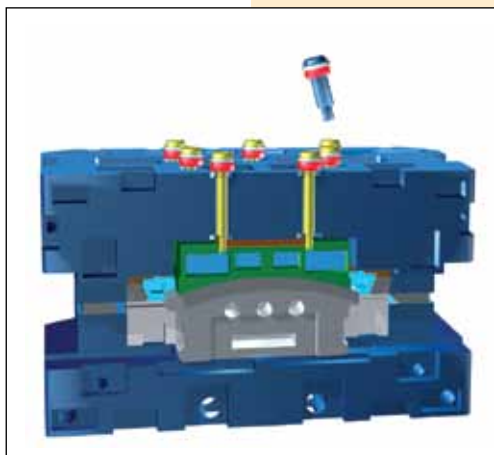

Down holder dampers for different retaining screw diameters were developed especially for pressing tools

Physical Properties of TUBUS Profile Dampers

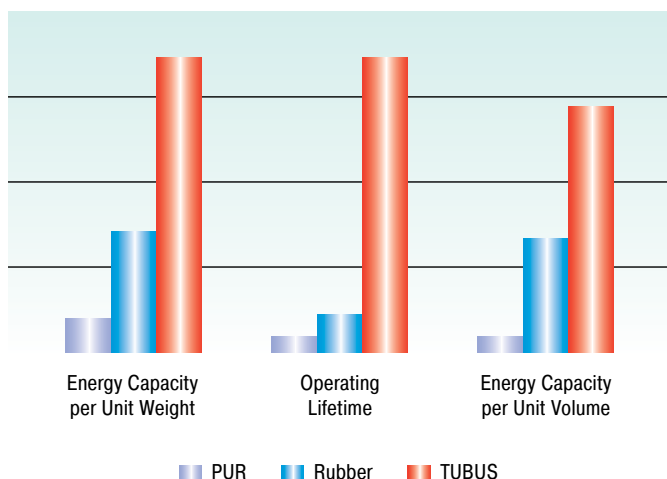

ACE TUBUS profile dampers are high performance damping elements made from a special Co-Polyester Elastomer. They have a high energy absorbing capacity compared with other materials. The TUBUS-series comprises 7 main types with over 140 individual models.

The excellent damping characteristics are achieved as a result of the special elastomer material and the worldwide patented construction design. This enables us to change the characteristics of the elastomer material so that individual and distinct damping curves are possible.

TUBUS dampers offer a considerable performance advantage when compared to other materials such as rubber, urethanes (PUR) and steel springs.

A further advantage compared to other damping elements is the **operating life expectancy – up to twenty times longer than with urethane dampers, up to ten times longer than with rubber dampers and up to five times longer than with steel spring dampers.**

Comparison of Damping Characteristics

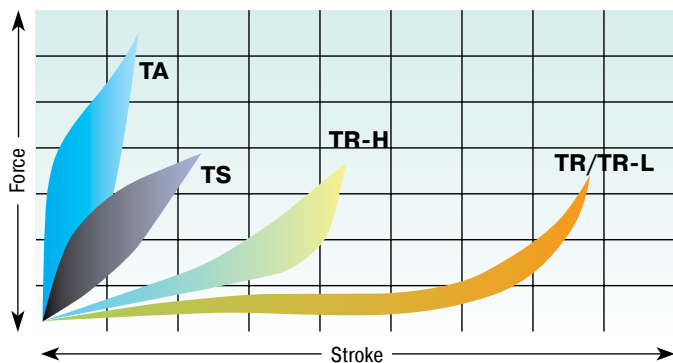

Characteristics of dynamic energy absorption for impact velocity over 0.5 m/s. For impact velocities under 0.5 m/s, please request a static characteristic curve.

The innovative TUBUS dampers absorb energy while exhibiting the following damping characteristics:

Model type TA: Degressive characteristic with max. energy absorption (coloured area) with min. stroke.
Energy absorption: 58 % to 73 %.

Model type TS: Almost linear characteristic with low reaction force over a short operating stroke.
Energy absorption: 35 % to 64 %.

TR/TR-H/TR-L: Progressive characteristic with gradually increasing reaction force over a long stroke.
Energy absorption **TR:** 25 % to 45 %
Energy absorption **TR-H:** 39 % to 62 %
Energy absorption **TR-L:** 26 % to 41 %

The material does not absorb water or swell and it is highly resistant to abrasion. Products of the TUBUS-series will work at **temperatures of -40 °C up to 90 °C** and are resistant to grease, oil, petroleum fluids, microbe and chemical attack and sea water. They also have good UV and ozone resistance. The **very long service life** of up to one million cycles, the **compact size** and the **low unit weight** differentiate the TUBUS profile dampers from all other types of elastomer damping elements.

If you are looking for an economic damping solution where the load does not need to be decelerated to an exact datum position and you do not need 100% absorption of the impact energy then TUBUS dampers are a real alternative to hydraulic end position damping. They are the preferred solution for end stop dampers in robotic systems, high bay warehouse systems and all similar automated plant and machinery.

For the crane industry we manufacture special **high capacity crane buffers** that have an ideal deceleration characteristic with high return force for this type of application and energy capacities from 450 to 17 810 Nm. This means you can have a TUBUS crane buffer capable of providing up to 900 kN of braking force in a package only weighing 1 kg and absorbing up to 50% of the energy.

Special Dampers

Besides the standard product range of the TUBUS-series there are also a large number of special products available upon request for customer-specific applications.

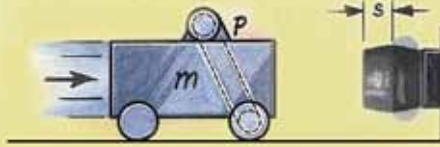

Safe end position damping

ACE TUBUS profile dampers protect the integrated loading station on a new high speed machining centre.

The ACE TUBUS damper is designed to prevent overrun on the high speed loading station of a Camshaft machining centre used in the automobile industry. In the event that the drive train fails during operation or incorrect data is inputted the ACE TUBUS damper absorbs the impact preventing costly damage to the machine. The **TA98-40** TUBUS damper impressed engineers with this exceptionally long service life in operation.

When used as an emergency stop the TUBUS damper can absorb up to 73 % of the impact energy.



Safety with ultra high speed operation

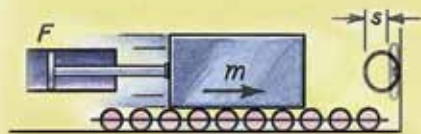

Smooth pivoting

TUBUS profile dampers safeguard hydraulic cylinders.

In a testing facility for vehicle tanks, the test specimens are pulled out of the water with a support arm. A hydraulic cylinder carries out the swinging movement and is attenuated in the end position by two TUBUS **TR85-50**.

Even if this work could be taken over by other absorber solutions, the energy balance clearly speaks for the benefits of the profile dampers – they are inexpensive, they save space, they are free of leaks due to solid construction and are suitable for underwater functions in the test pool.



With the kind permission of Worthmann Maschinenbau GmbH
Economical end position absorption on the hydraulic drive

SLAB damping plates of the **SL-030, SL-100 and SL-300 series** are visco-elastic PUR materials that are manufactured according to a patented formula and which were especially designed to absorb shock loads. At the same time, the resulting structure-borne noise is effectively reduced. This material is characterized by its very high inner damping. The rebound elasticity is around $< 30\%$ (Tolerance $\pm 10\%$). The result makes this product an alternative to hydraulic end-of-travel damping, if the load doesn't need to be stopped accurately and the energy doesn't have to be reduced by 100%.

The densities of
 SL-030 = 270 kg/m³,
 SL-100 = 500 kg/m³ and
 SL-300 = 800 kg/m³
 cover a wide spectrum of the energy absorption to the applied area. This enables a relatively independent choice of applied area.

"Large area
 shock absorption!"

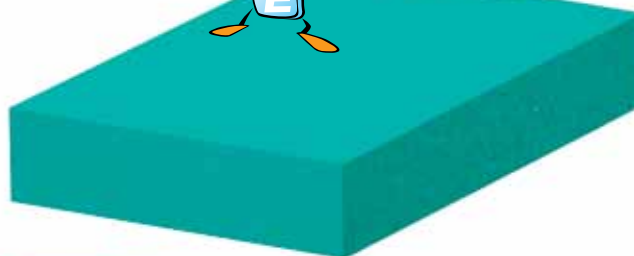

Impact velocity range: max. 5 m/s

Compression set: $\leq 5\%$, at 50 % of compression, 23 °C, 70 h, 30 min after unloading, according to EN ISO 1856

Environment: Resistant against ozone and UV radiation (also see chemical resistancy page 111)

Material: Mixed cellular PUR-Elastomer (polyether urethane), standard colour green

Standard density: 270 kg/m³, 500 kg/m³ and 800 kg/m³

Impact resilience: $< 30\%$, tolerance $\pm 10\%$, SL-030 and SL-100 according to DIN 53573, SL-300 according to DIN 53512 (measurement following the respective standard).

Fire rating: B2, normally flammable according to DIN 4102

Operating temperature range: -5 °C to +50 °C, short-term higher temperature possible.

Delivery form: Thickness: 12.5 mm and 25 mm. Rolls: 1.5 m wide, 5.0 m long. Strips: Up to the maximum width and length. Other dimensions (also thickness), colours, shapes and cut-out parts on request.

Possibilities for cutting: Water jet cutting, stamping, splitting, sawing, drilling etc.

Mounting style: Bonding (see adhesive recommendation page 110), clamps, screws, etc.

On request: Available with compact polyurethane wearing surface, shore hardness: 82 shore Sh A.

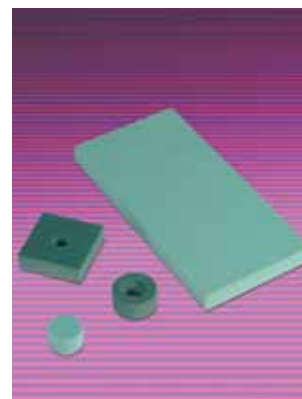

Ordering Example

ACE-SLAB _____
 Material Type _____
 Material Thickness 12.5 mm _____
 Customers Specific Dimension/Shape _____
 (D-Number is assigned by ACE)

SL-030-12-Dxxxx

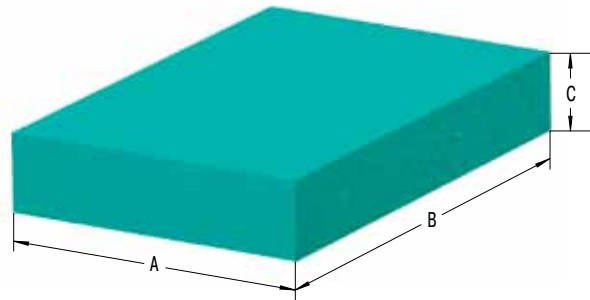

The chosen damping plate should be tested by the customer on the specific application.

Characteristics of Type SL-030-12

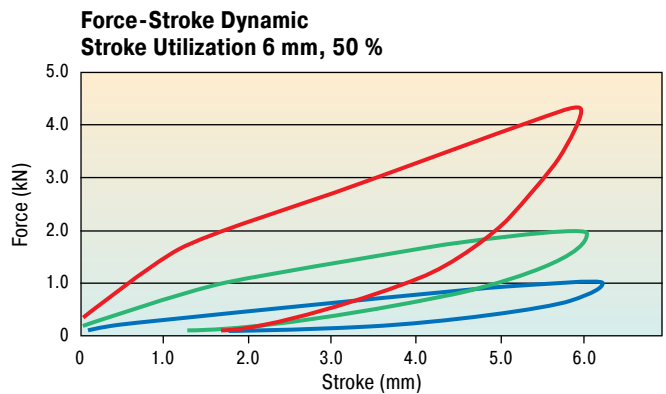
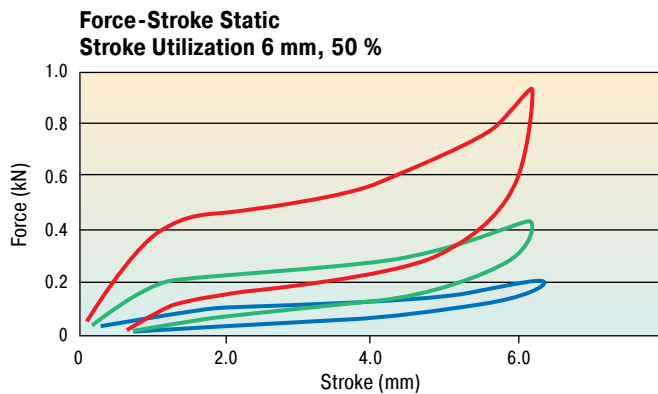
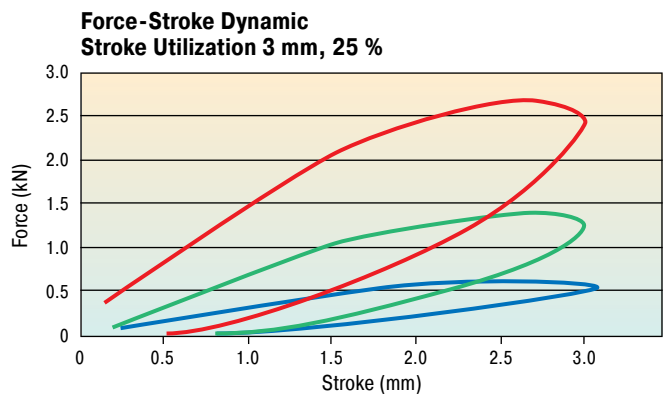
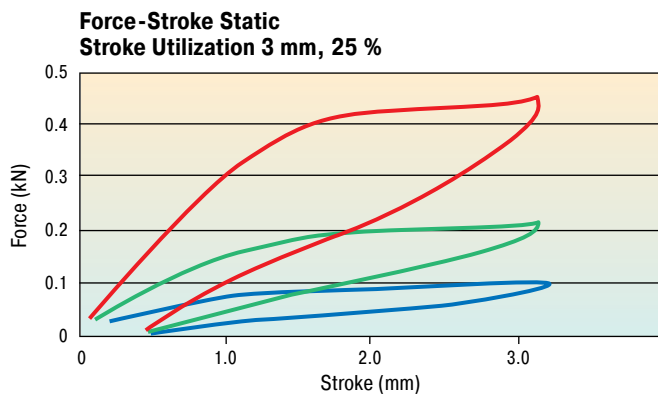

Load data:
 static, between two level plates
 deformation velocity:
 1 % of the plate thickness/sec.

— Area 10 000 mm²
 — Area 5 000 mm²
 — Area 2 500 mm²

Load data:
 dynamic, free-falling mass,
 impact velocity:
 about 1 m/s.

Dimensions and Capacity Chart (Sample Plates MP1 to MP3)

Type	¹ W ₃ max. Nm/Cycle	¹ Stroke Utilization mm	A	B	C	Area mm ²	Density kg/m ³	Return Time s	Weight kg
SL-030-12-D-MP1	2.3 (5.0)	3 (6)	50	50	12.5	2 500	270	Approx. 3 (4)	0.008
SL-030-12-D-MP2	4.3 (9.5)	3 (6)	70.7	70.7	12.5	5 000	270	Approx. 3 (4)	0.017
SL-030-12-D-MP3	9.5 (19.5)	3 (6)	100	100	12.5	10 000	270	Approx. 3 (4)	0.034

¹ Energy absorption and stroke utilization as well as the illustrated dynamic curve progression refer to a calculated free falling mass with an impact velocity of 1 m/s. For differing application data, these values can only be used as a reference. The energy absorption depends on the individual impact surface and stroke utilization. The longer the load duration the more the reduction in energy absorption (material fatigue).

Ordering Example

ACE-SLAB _____
 Material Type _____
 Material Thickness 25 mm _____
 Customers Specific Dimension/Shape _____
 (D-Number is assigned by ACE)

SL-030-25-Dxxxx

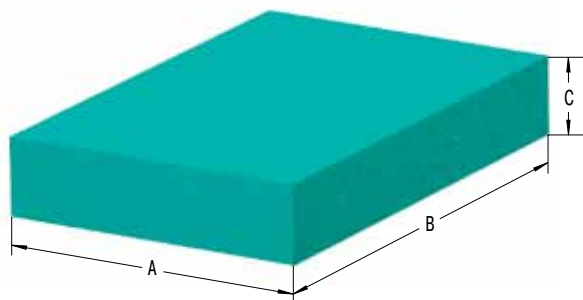

The chosen damping plate should be tested by the customer on the specific application.

Characteristics of Type SL-030-25

Force-Stroke Static
Stroke Utilization 6 mm, 25 %

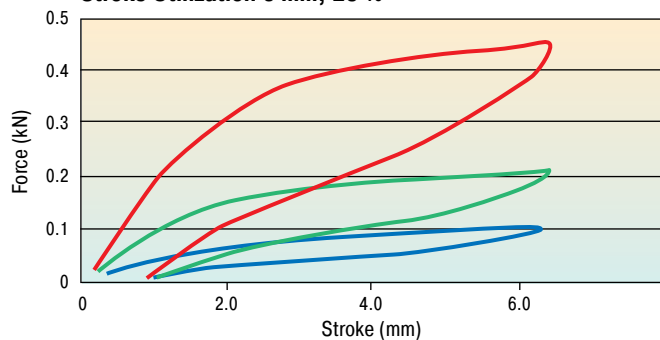

Force-Stroke Dynamic
Stroke Utilization 6 mm, 25 %

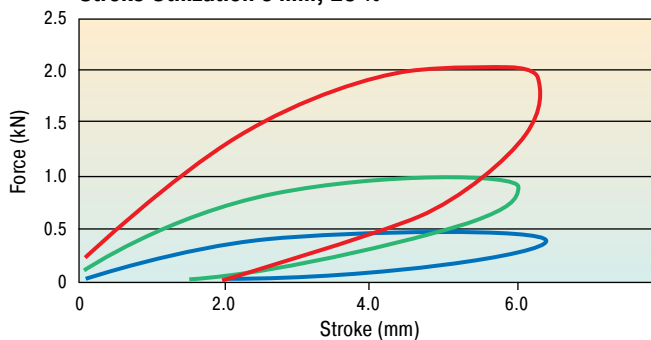

Force-Stroke Static
Stroke Utilization 12 mm, 50 %

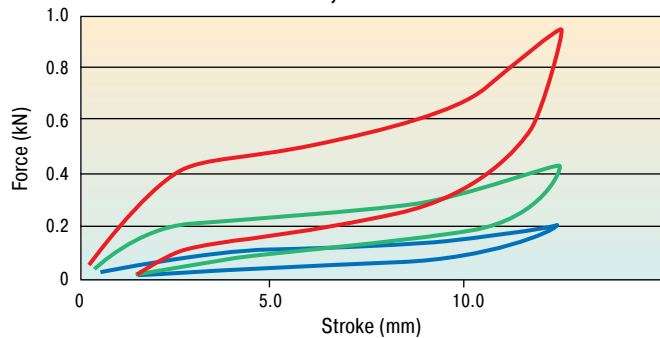

Force-Stroke Dynamic
Stroke Utilization 12 mm, 50 %

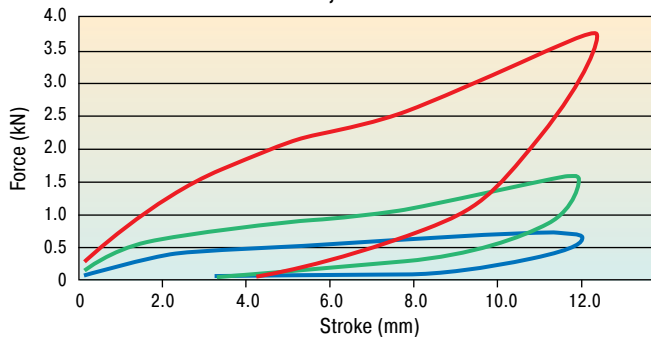

Load data:
 static, between two level plates
 deformation velocity:
 1 % of the plate thickness/sec.

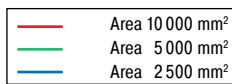

Load data:
 dynamic, free-falling mass,
 impact velocity:
 about 1 m/s.

Dimensions and Capacity Chart (Sample Plates MP1 to MP3)

Type	¹ W ₃ max. Nm/Cycle	¹ Stroke Utilization mm	A	B	C	Area mm ²	Density kg/m ³	Return Time s	Weight kg
SL-030-25-D-MP1	3.5 (6.0)	6 (12)	50	50	25	2 500	270	Approx. 4 (5)	0.017
SL-030-25-D-MP2	5.7 (11.5)	6 (12)	70.7	70.7	25	5 000	270	Approx. 4 (5)	0.034
SL-030-25-D-MP3	11.5 (21.5)	6 (12)	100	100	25	10 000	270	Approx. 4 (5)	0.068

¹ Energy absorption and stroke utilization as well as the illustrated dynamic curve progression refer to a calculated free falling mass with an impact velocity of 1 m/s. For differing application data, these values can only be used as a reference. The energy absorption depends on the individual impact surface and stroke utilization. The longer the load duration the more the reduction in energy absorption (material fatigue).

Ordering Example

ACE-SLAB _____
 Material Type _____
 Material Thickness 12.5 mm _____
 Customers Specific Dimension/Shape _____
 (D-Number is assigned by ACE)

SL-100-12-Dxxxx

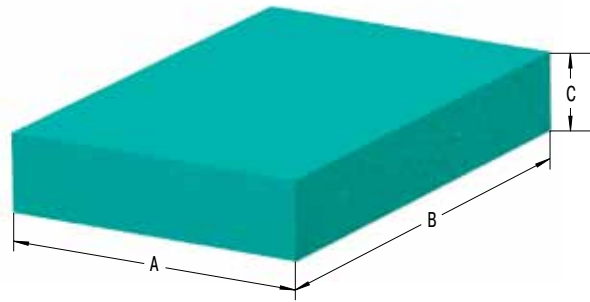

The chosen damping plate should be tested by the customer on the specific application.

Characteristics of Type SL-100-12

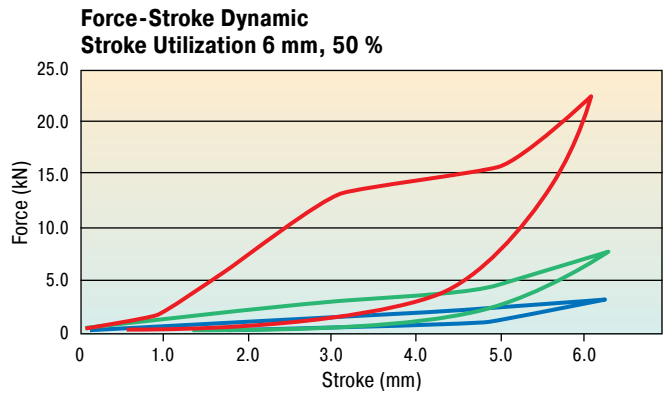
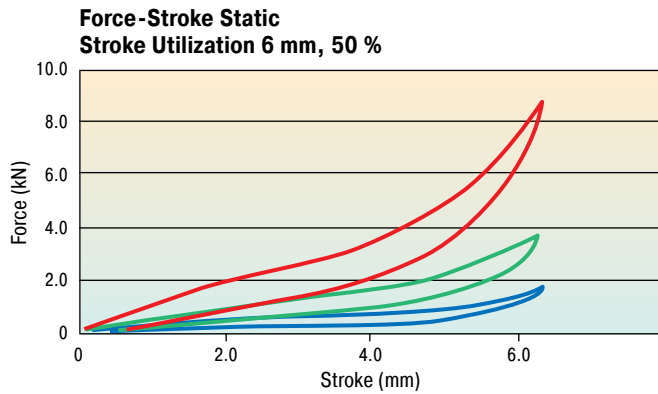
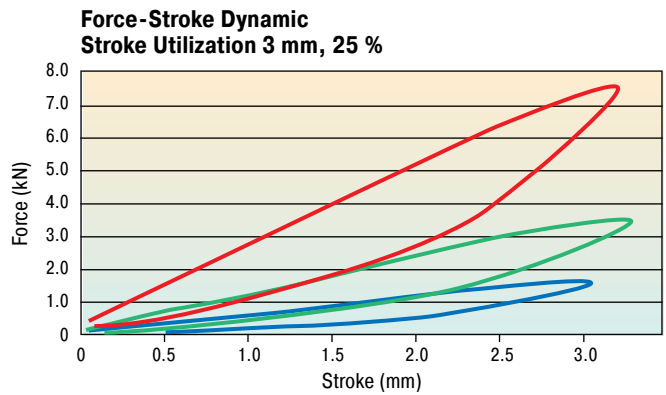
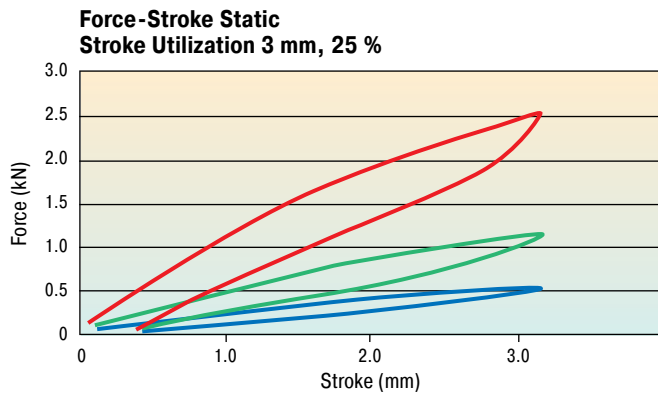

Load data:
 static, between two level plates
 deformation velocity:
 1 % of the plate thickness/sec.

— Area 10 000 mm²
 — Area 5 000 mm²
 — Area 2 500 mm²

Load data:
 dynamic, free-falling mass,
 impact velocity:
 about 1 m/s.

Dimensions and Capacity Chart (Sample Plates MP1 to MP3)

Type	¹ W ₃ max. Nm/Cycle	¹ Stroke Utilization mm	A	B	C	Area mm ²	Density kg/m ³	Return Time s	Weight kg
SL-100-12-D-MP1	4.5 (13.0)	3 (6)	50	50	12.5	2 500	500	Approx. 3 (4)	0.016
SL-100-12-D-MP2	11.5 (29.0)	3 (6)	70.7	70.7	12.5	5 000	500	Approx. 3 (4)	0.031
SL-100-12-D-MP3	23.0 (75.0)	3 (6)	100	100	12.5	10 000	500	Approx. 3 (4)	0.063

¹ Energy absorption and stroke utilization as well as the illustrated dynamic curve progression refer to a calculated free falling mass with an impact velocity of 1 m/s. For differing application data, these values can only be used as a reference. The energy absorption depends on the individual impact surface and stroke utilization. The longer the load duration the more the reduction in energy absorption (material fatigue).

Ordering Example

ACE-SLAB _____
 Material Type _____
 Material Thickness 25 mm _____
 Customers Specific Dimension/Shape _____
 (D-Number is assigned by ACE)

SL-100-25-Dxxxx

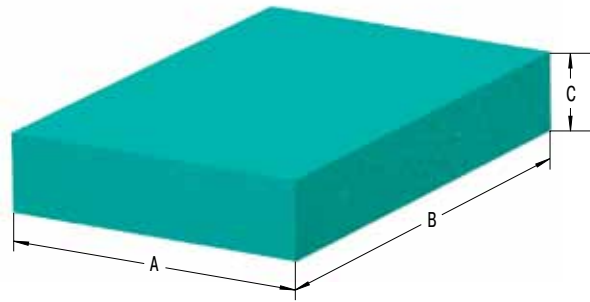

The chosen damping plate should be tested by the customer on the specific application.

Characteristics of Type SL-100-25

Force-Stroke Static
Stroke Utilization 6 mm, 25 %

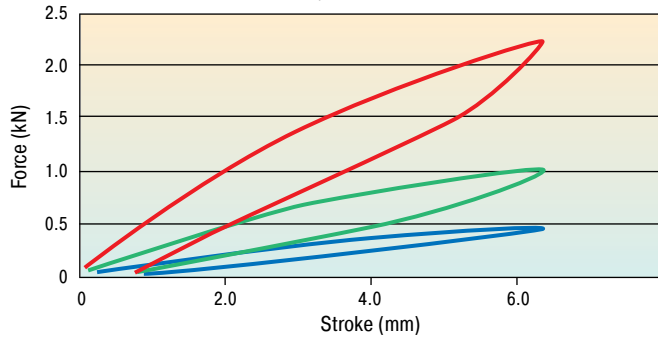

Force-Stroke Dynamic
Stroke Utilization 6 mm, 25 %

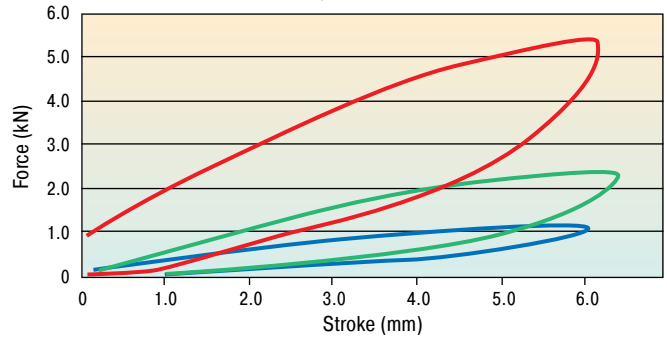

Force-Stroke Static
Stroke Utilization 12 mm, 50 %

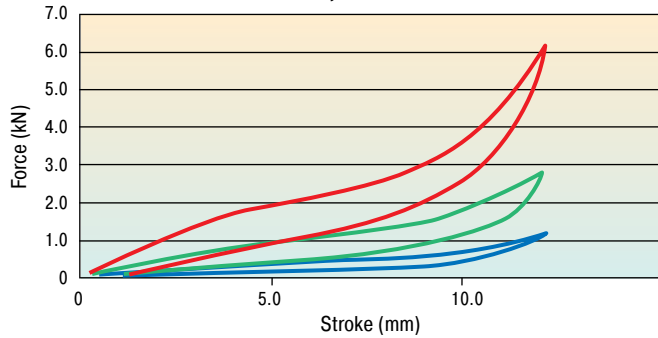

Force-Stroke Dynamic
Stroke Utilization 12 mm, 50 %

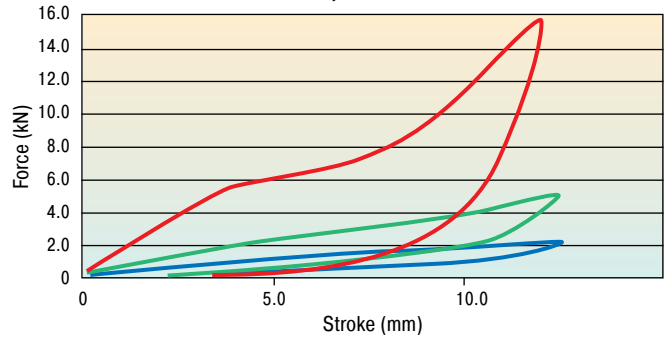

Load data:
 static, between two level plates
 deformation velocity:
 1 % of the plate thickness/sec.

— Area 10 000 mm²
 — Area 5 000 mm²
 — Area 2 500 mm²

Load data:
 dynamic, free-falling mass,
 impact velocity:
 about 1 m/s.

Dimensions and Capacity Chart (Sample Plates MP1 to MP3)

Type	¹ W ₃ max. Nm/Cycle	¹ Stroke Utilization mm	A	B	C	Area mm ²	Density kg/m ³	Return Time s	Weight kg
SL-100-25-D-MP1	5.7 (14.5)	6 (12)	50	50	25	2 500	500	Approx. 4 (5)	0.031
SL-100-25-D-MP2	11.5 (33.0)	6 (12)	70.7	70.7	25	5 000	500	Approx. 4 (5)	0.062
SL-100-25-D-MP3	28.5 (90.0)	6 (12)	100	100	25	10 000	500	Approx. 4 (5)	0.125

¹ Energy absorption and stroke utilization as well as the illustrated dynamic curve progression refer to a calculated free falling mass with an impact velocity of 1 m/s. For differing application data, these values can only be used as a reference. The energy absorption depends on the individual impact surface and stroke utilization. The longer the load duration the more the reduction in energy absorption (material fatigue).

Ordering Example

ACE-SLAB _____
 Material Type _____
 Material Thickness 12.5 mm _____
 Customers Specific Dimension/Shape _____
 (D-Number is assigned by ACE)

SL-300-12-Dxxxx

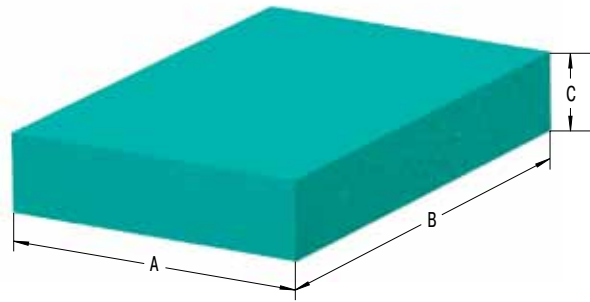

The chosen damping plate should be tested by the customer on the specific application.

Characteristics of Type SL-300-12

Force-Stroke Static
Stroke Utilization 3 mm, 25 %

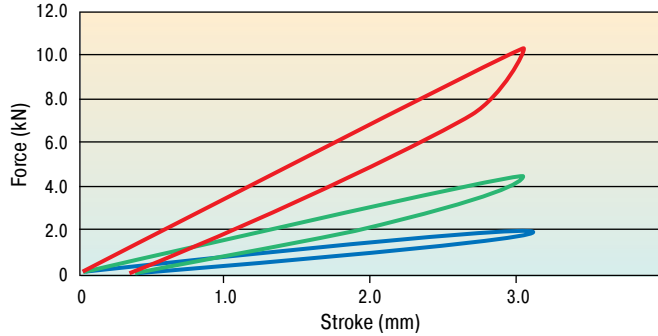

Force-Stroke Dynamic
Stroke Utilization 3 mm, 25 %

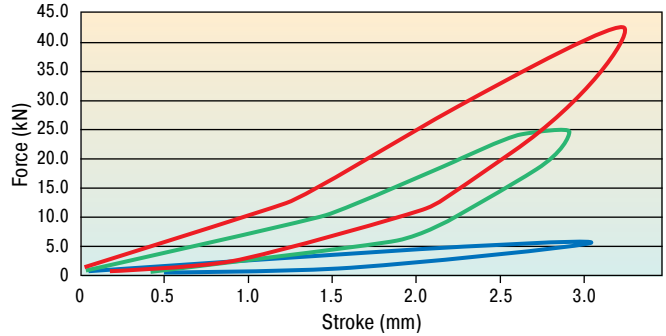

Force-Stroke Static
Stroke Utilization 6 mm, 50 %

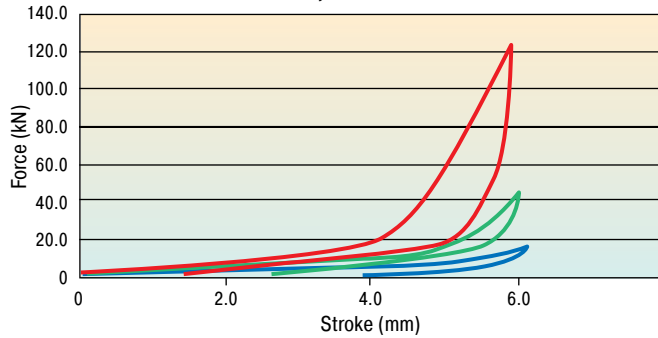

Force-Stroke Dynamic
Stroke Utilization 6 mm, 50 %

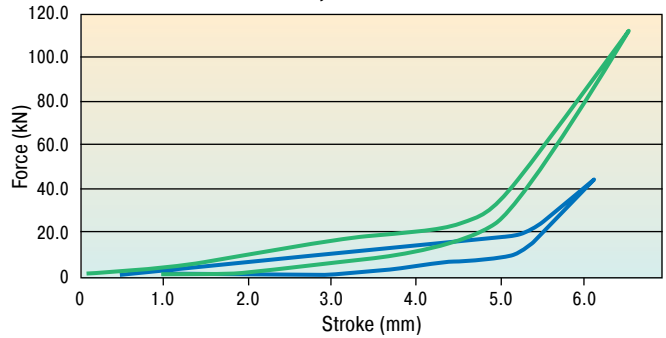

Load data:
 static, between two level plates
 deformation velocity:
 1 % of the plate thickness/sec.

— Area 10 000 mm²
 — Area 5 000 mm²
 — Area 2 500 mm²

Load data:
 dynamic, free-falling mass,
 impact velocity:
 about 1 m/s.

Dimensions and Capacity Chart (Sample Plates MP1 to MP3)

Type	¹ W ₃ max. Nm/Cycle	¹ Stroke Utilization mm	A	B	C	Area mm ²	Density kg/m ³	Return Time s	Weight kg
SL-300-12-D-MP1	17.0 (85.0)	3 (6)	50	50	12.5	2 500	800	Approx. 2 (3)	0.025
SL-300-12-D-MP2	50.0 (250.0)	3 (6)	70.7	70.7	12.5	5 000	800	Approx. 2 (3)	0.050
SL-300-12-D-MP3	100.0	3 (6)	100	100	12.5	10 000	800	Approx. 2 (3)	0.100

¹ Energy absorption and stroke utilization as well as the illustrated dynamic curve progression refer to a calculated free falling mass with an impact velocity of 1 m/s. For differing application data, these values can only be used as a reference. The energy absorption depends on the individual impact surface and stroke utilization. The longer the load duration the more the reduction in energy absorption (material fatigue).

Ordering Example

ACE-SLAB _____
 Material Type _____
 Material Thickness 25 mm _____
 Customers Specific Dimension/Shape _____
 (D-Number is assigned by ACE)

SL-300-25-Dxxxx

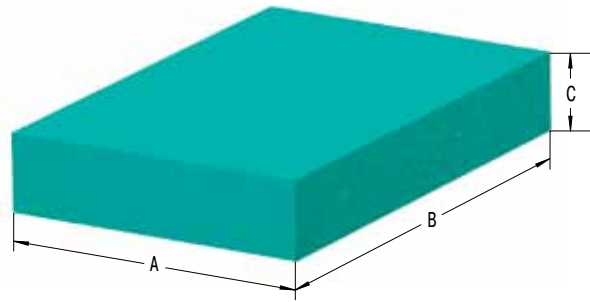

The chosen damping plate should be tested by the customer on the specific application.

Characteristics of Type SL-300-25

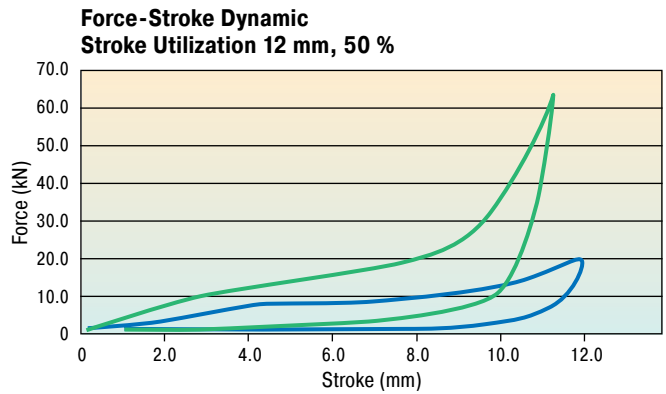
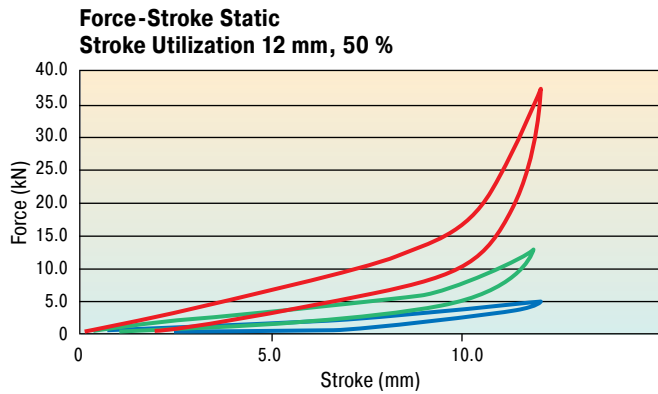
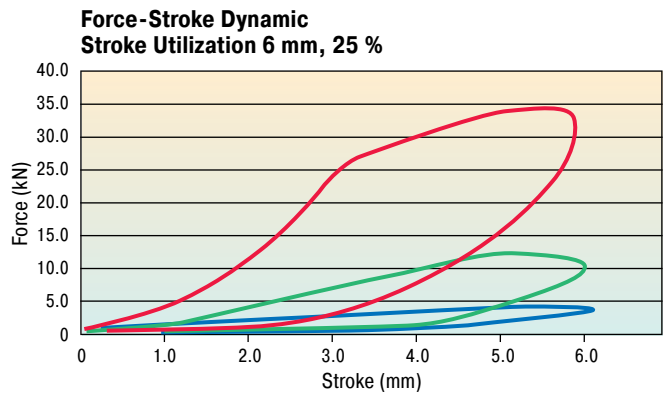
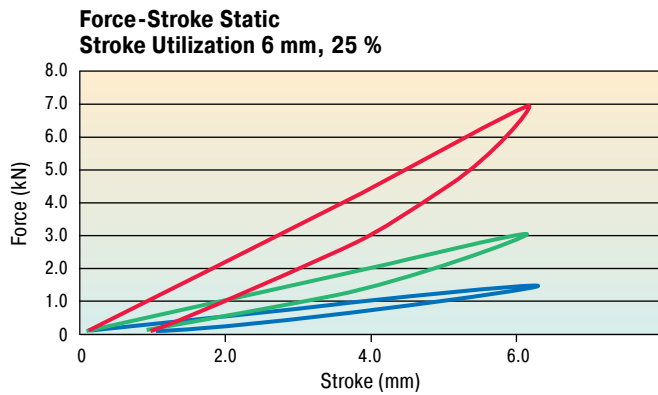

Load data:
 static, between two level plates
 deformation velocity:
 1 % of the plate thickness/sec.

— Area 10 000 mm²
 — Area 5 000 mm²
 — Area 2 500 mm²

Load data:
 dynamic, free-falling mass,
 impact velocity:
 about 1 m/s.

Dimensions and Capacity Chart (Sample Plates MP1 to MP3)

Type	¹ W ₃ max. Nm/Cycle	¹ Stroke Utilization mm	A	B	C	Area mm ²	Density kg/m ³	Return Time s	Weight kg
SL-300-25-D-MP1	19.5 (90.0)	6 (12)	50	50	25	2500	800	Approx. 3 (4)	0.050
SL-300-25-D-MP2	50.0 (225.0)	6 (12)	70.7	70.7	25	5000	800	Approx. 3 (4)	0.100
SL-300-25-D-MP3	150.0	6 (12)	100	100	25	10000	800	Approx. 3 (4)	0.200

¹ Energy absorption and stroke utilization as well as the illustrated dynamic curve progression refer to a calculated free falling mass with an impact velocity of 1 m/s. For differing application data, these values can only be used as a reference. The energy absorption depends on the individual impact surface and stroke utilization. The longer the load duration the more the reduction in energy absorption (material fatigue).

SLAB damping plates of the SL-170 to SL-720 are universally applicable elastic PUR materials that are manufactured according to a patented formula and which are used throughout industry. The standard densities of 170 kg/m³ to 720 kg/m³ serve as vibration insulation in a wide variety of applications. For specific applications, special designs with specific densities can be manufactured. The static and dynamic product characteristics are precisely defined. The effectiveness of elastic suspension can be calculated in advance. The necessary parameters are shown on a respective checklist.

The static load capacity of standard materials are in the range of:

- SL-170: 0 to 0.011 N/mm²
- SL-210: 0 to 0.028 N/mm²
- SL-275: 0 to 0.055 N/mm²
- SL-450: 0 to 0.15 N/mm²
- SL-600: 0 to 0.30 N/mm²
- SL-720: 0 to 0.50 N/mm²

and for special designs up to 0.8 N/mm². Unusual and light loads can withstand forces of 5.0 N/mm². This value can reach up to 6 N/mm² for special designs.

"Efficiency of the elastic damping can be calculated in advance!"



Our local service: We will help you to understand vibration problems correctly, to optimise existing systems and to find tailor-made solutions. Our trained field staff are at your disposal with the necessary equipment. The use of the latest hardware and software allows us to determine the interference frequencies, which may arise, and at the same time offer you a variety of possible solutions of how to best isolate vibration in your installation. Our newly developed calculation program SLAB-Calc is able to work with a level of input data never known before. With this and with the help of various individual filter functions it is possible to determine the dynamic behaviour of rotating and oscillating masses so accurately that efficient countermeasures can be introduced. The exact defined structural and dynamic characteristics and the high level of production accuracy of our ACE-SLAB damping plates allow such a precise calculation.

Detailed information of these and similar products can be found in the special catalogue on our homepage

www.ace-ace.com

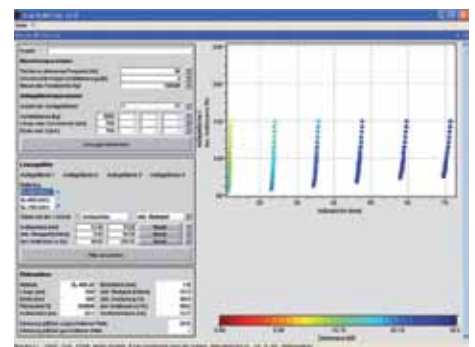

Bonding of Polyurethane (PUR) Elastomers

Cellular and compact parts of polyurethane (PUR) elastomers SLAB damping plates can be bonded according to the following recommendations. If treatment instructions are followed, the strengths of the bonded joint can be equivalent to the elastomer material itself.

1. General Information

To achieve the required bonding strength it is necessary to ensure the correct adhesive is chosen for each individual application.

Contact bonding material: Thin adhesive film, with little filling of the gaps. Correcting or moving of the areas covered with bonding material is no longer possible after the first contact is made (contact effect).

Once a bonding is separated, the bonding process must be renewed.

Please note that creases, ripples or blisters cannot be straightened once the contact is made.

Hardening bonding material: (As thin as possible) the film of glue fills the joint. The gluing can be done after the edges are brought together.

2. Preparation

The preparation of bonding surfaces is of significant importance for the bonding strength. The surfaces must be adapted to each other and available in plain, clean form.

Careful removal of: Adhesive remnants, oil, fat, separating agents, dirt, dust, scales, molding layers, protective coating, finish, paint, sweat etc.

Mechanical support: Stripping, brushing, scraping, grinding, sandblasting.

Chemical support: Degreasing (washing off with grease remover), etching, priming; pay attention to chemical resistancy on page 111!

In general, SLAB damping plates in sheet form can be bonded without pretreatment. Molded parts, with or without special skin, have to be cleaned from left-over separating agents, if necessary by grinding. When bonding with other materials like plastic, wood, metal or concrete, mechanical and/or chemical additives have to be used.

The adhesive has to be prepared according to the formula, observing the manufacturer's recommendations. The adhesive film is also to be carefully applied pursuant to these details. (Tools: brush, spatula, adhesive spreader, airless spray gun).

Contact bonding material: Apply the non-gap-filling adhesive film to both bonding surfaces – the thinner, the better. To close the pores of low density materials, two layers may be necessary.

Hardening bonding material: Apply evenly. Possible irregularities can be compensated by the film thickness.

3. Bonding

When using contact bonding material, the flash off time has to be kept in mind. Especially, with systems containing water instead of usual solvents, the adhesive film must be as dry as possible in order to pass the 'finger test' – no marks appear when touching the adhesive surface. When using hardening bonding material, the parts have to be joined immediately after applying the bonding material.

4. Pressing

Contact bonding material: Contact pressure up to 0.5 N/mm²

Hardening bonding material: Fix firmly

It is important to carefully follow the manufacturer's instructions with regard to processing temperature, hardening time and earliest possible loading.

5. Selection of Approved Bonding Materials

Because of the variety of materials that can be bonded together as well as numerous suitable bonding materials, we refer you to a worldwide leading producer of bonding and sealing materials.

Sika Deutschland GmbH
Kornwestheimer Str. 103-107
D-70439 Stuttgart
Tel.: +49-711-8009-0
Fax: +49-711-8009-321
E-Mail: info@de.sika.com
Internet: <http://www.sika.de>

Test (following DIN 53428)

Exposure time of the medium: 6 weeks at room temperature, but for concentrated acids and bases as well as solvents: 7 days at room temperature

Evaluation Criteria

Changing of tensile strength and elongation of break (dry samples), change in volume

Evaluation Standard

- 1 Excellent resistance,**
change in characteristics < 10 %
- 2 Good resistance,**
change in characteristics between 10 % and 20 %
- 3 Conditional resistance,**
change in characteristics partly above 20 %
- 4 Not resistant,**
change in characteristics all above 20 %

All information is based on our current knowledge and experiences. We reserve the rights for changes towards product refinement.

Chemical Resistance

	SL-030 to SL-300	SL-170 to SL-720		SL-030 to SL-300	SL-170 to SL-720
Water/Watery Solutions			Acids and Bases		
Water	1	1	Formic acid 5 %	3	3
Iron(III) chloride 10 %	1	1	Acetic acid 5 %	2	2
Sodium carbonate 10 %	1	1	Phosphoric acid 5 %	1	1
Sodium chlorate 10 %	1	1	Nitric acid 5 %	4	4
Sodium chloride 10 %	1	1	Hydrochloric acid 5 %	1	1
Sodium nitrate 10 %	1	1	Sulphuric acid 5 %	1	1
Tensides (div.)	1	1	Ammonia solution 5 %	1	1
Hydrogen peroxide 3 %	1	1	Caustic potash solution 5 %	1	1
Laitance	1	1	Caustic soda solution 5 %	1	1
Oils and Greases			Solvents		
ASTM Oil No. 1	1	1	Acetone	4	4
ASTM Oil No. 3	1	2	Diesel/Fuel oil	2	2
Laitance	2	2	Carburetor fuel/Benzine	3	3
Hydraulic oils	depends on consistency/additives		Glycerin	1	1
Motor oil	1	1	Glycols	1-2	2
Formwork oil	1	1	Cleaning solvents/Hexane	1	2
High performance grease	1-2	3	Methanol	3	4
Railroad switch lubricant	1-2	1-2	Aromatic hydrocarbons	4	4
			Other Factors		
			Hydrolysis *	1	1
			Ozone	1	1
			UV radiation and weathering	1-2	1-2
			Biological resistance	1	1

* 28 days, 70 °C, 95 % relative humidity

Sample Plates and Sample Sets

Sample Plates Shock Absorption

Part Number

Part Number	Dimensions and Type
SL-030-12-D-MP4	220 x 150 x 12.5 mm
SL-030-12-D-MP4-V+K	220 x 150 x 12.5 mm + layer for wear protection 2 mm, self-adhesive on one side
SL-030-25-D-MP4	220 x 150 x 25 mm
SL-100-12-D-MP4	220 x 150 x 12.5 mm
SL-100-12-D-MP4-V+K	220 x 150 x 12.5 mm + layer for wear protection 2 mm, self-adhesive on one side
SL-100-25-D-MP4	220 x 150 x 25 mm
SL-300-12-D-MP4	220 x 150 x 12.5 mm
SL-300-12-D-MP4-V+K	220 x 150 x 12.5 mm + layer for wear protection 2 mm, self-adhesive on one side
SL-300-25-D-MP4	220 x 150 x 25 mm

Sample Sets

Individually arranged sample sets are available on request!
3 densities. Dimensions: 50 x 50 mm, 70.7 x 70.7 mm and 100 x 100 mm.
Thickness: 12.5 and 25 mm

Sample Plates Vibration Damping

Part Number

Part Number	Dimensions and Type
SL-170-12-F-MP4	220 x 150 x 12.5 mm
SL-170-25-F-MP4	220 x 150 x 25 mm
SL-210-12-F-MP4	220 x 150 x 12.5 mm
SL-210-25-F-MP4	220 x 150 x 25 mm
SL-275-12-F-MP4	220 x 150 x 12.5 mm
SL-275-25-F-MP4	220 x 150 x 25 mm
SL-450-12-F-MP4	220 x 150 x 12.5 mm
SL-450-25-F-MP4	220 x 150 x 25 mm
SL-600-12-F-MP4	220 x 150 x 12.5 mm
SL-600-25-F-MP4	220 x 150 x 25 mm
SL-720-12-F-MP4	220 x 150 x 12.5 mm
SL-720-25-F-MP4	220 x 150 x 25 mm



Noise reduction

ACE-SLAB damping plates protect man and machine.

At the beginning of the construction phase of a modern processing centre at the end position, a 25 kg cable channel collided with force against the housing and produced a deafening noise and mechanical strain on the energy chain. A reliable solution for compliance with the operational parameters was realized with the **SL-030-25-Dxxxx** type ACE-SLAB damping plates even before the milling machine was finished.



Low-noise energy chain

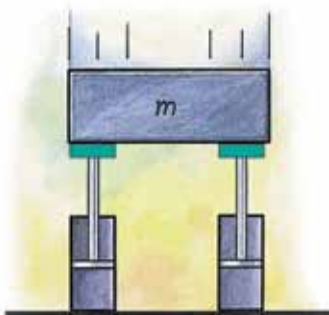

Impact reduction in ring form

ACE-SLAB damping plates make tyre transport safer.

Developed for absorbing the impact of forces, the ACE-SLAB damping plates **SL-030-121-Dxxxx** applied in this tyre testing system are ideal for protecting the sliding parts of the machine during quality tests.

The individual customisation of the ring form of the centre arm and simple integration into the equipment also support the decision for applying these innovative absorber elements.



With the kind permission of SDS Systemtechnik GmbH, www.sds-systemtechnik.de
Perfectly fitted machine protection



Damping combination SLAB – TUBUS

SLAB-TUBUS-Combination ensures fast luggage transport. Airports endeavour to shorten air passengers' waiting times as much as possible. This aim is met with a solution especially developed for luggage transport systems and has solved previous damping issue. Transport carriers with a weight of up to 120 kg can now be moved at the desired conveyor belt speeds.

A SLAB-combination of the material **SL-030-12(25)-Dxxxx** together with two **TA40-16** type TUBUS profile dampers are used here. Impact speeds of up to 3 m/s are reliably absorbed by the SLAB material. Integrated TUBUS dampers support the process at impact speeds greater than 3 m/s.



Fast luggage transport for airport customers

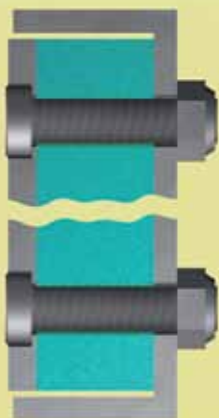

Impact protection for large areas

ACE-SLAB damping plates offer impact protection for wooden battens.

To protect wooden battens with differing weights and impact speeds of approx. 2 m/s, the SLAB-material **SL-030-12-Dxxxx** was screwed across the whole surface between two steel sheets in this application. This creates an even damping effect over the whole impact area, which protects the impact surfaces of the battens from an excessive impact load.

The minimisation of recoil as well as reduction of noise are further positive side effects of this construction.



Impact protection for wooden battens

ACE rotary dampers are maintenance-free and ready to install. The damping direction of the rotary dampers with continuous rotation can be clockwise, counter clockwise, or in both directions. The outer body is either of metal or plastic. Rotary dampers with continuous rotation ensure the controlled opening and closing of small hoods, compartments and drawers. They can damp directly at the rotation point or linearly by means of a rack and pinion, in order to produce a smooth and even movement. Sensitive components remain unstressed. The harmonious gentle movement process enhances the quality and value of the product. Plastic racks (modules 0.5 to 1.0) are available for the rotary dampers with pinions. Particularly suitable for flaps, closing hoods, CD-player drawers, vehicle glove compartments, the furniture industry etc.

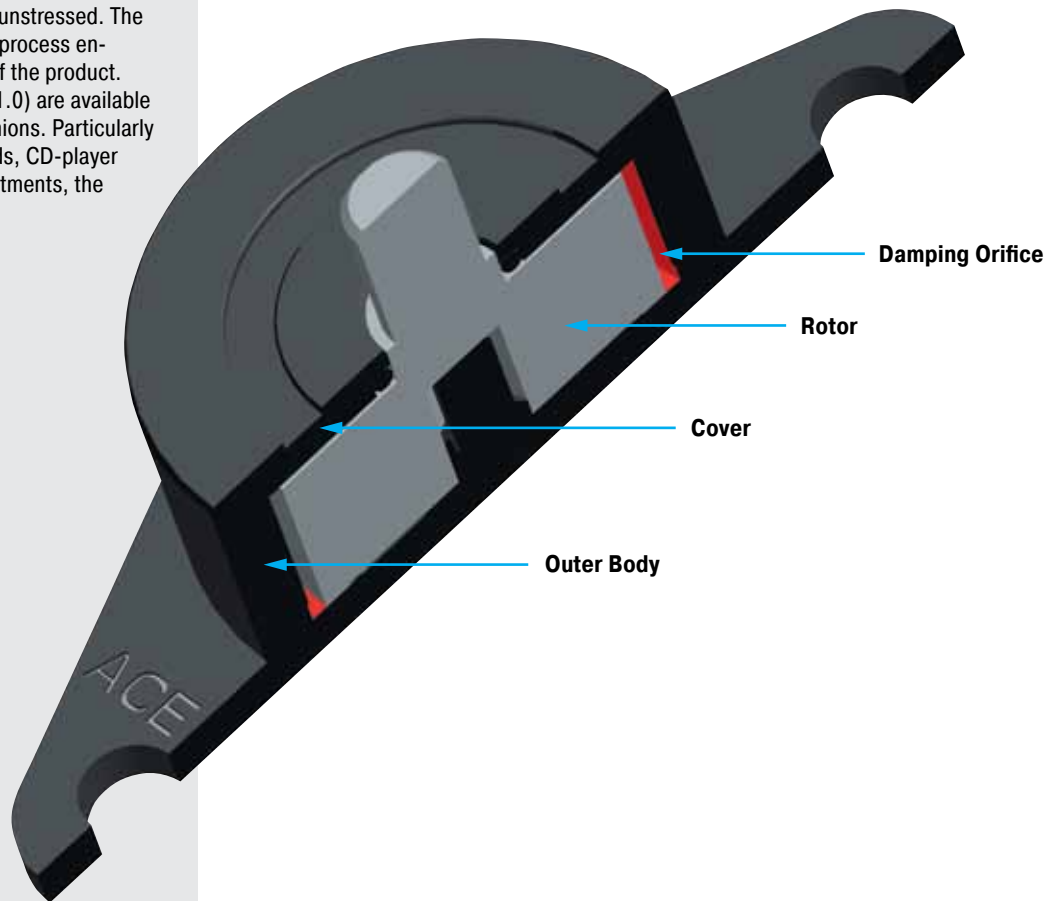

Function: In rotary dampers with continuous rotation, a fluid damping is produced by the shearing of thin silicon layers between the surfaces of a rotor and a stator. The damping moment is determined by the viscosity of the fluid and the dimensioning of the throttle gap. The specified damping moments refer to a speed of 20 rpm and an ambient temperature of 23 °C.

Note: In general, ACE rotary dampers are tested for a service life of 50 000 cycles. Even after this time, the dampers still produce over approx. 80% of their original damping moment. The service life may be significantly higher or lower, depending on the application. Much higher service lives have however been achieved in practice.



FRT-E2

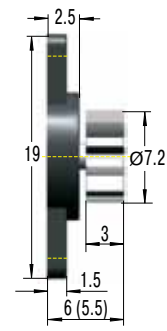
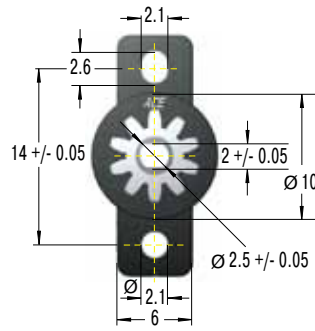

Dims. in () without gear

Technical Data

Pressure angle: 20°
Material: Polycarbonate plastic
Tooth: Involute
P.C.D.: 6 mm
No. of teeth: 10
Module: 1 0.6
Operating temperature range: 0 °C to 50 °C

FRT-E2 (at 23 °C)

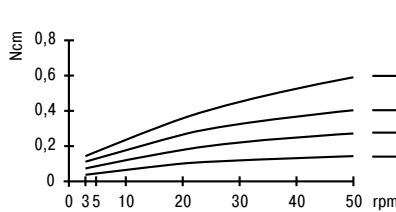

FRT-E2 (at 20 rpm)

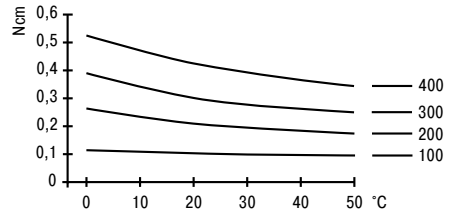

¹ A 250 mm long plastic rack is available for use with this part see page 124.

Damping in both Directions of Rotation

Without Gear	Nominal 20 rpm. 23 °C Damping Torque Ncm
FRT-E2-100	0.10 +/- 0.05
FRT-E2-200	0.20 +/- 0.07
FRT-E2-300	0.30 +/- 0.08
FRT-E2-400	0.40 +/- 0.10

Damping in both Directions of Rotation

With Gear	Nominal 20 rpm. 23 °C Damping Torque Ncm
FRT-E2-100-G1	0.10 +/- 0.05
FRT-E2-200-G1	0.20 +/- 0.07
FRT-E2-300-G1	0.30 +/- 0.08
FRT-E2-400-G1	0.40 +/- 0.10

FRT-G2

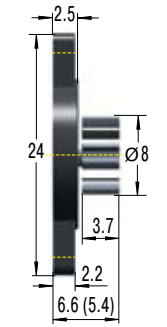
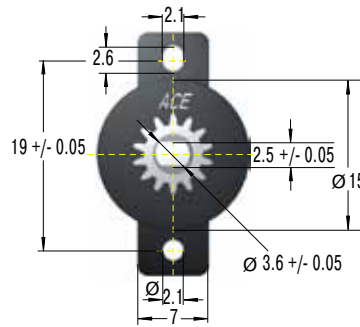

Dims. in () without gear

Technical Data

Pressure angle: 20°
Material: Polycarbonate plastic
Tooth: Involute
P.C.D.: 7 mm
No. of teeth: 14
Module: 1 0.5
Operating temperature range: 0 °C to 50 °C

FRT-G2 (at 23 °C)

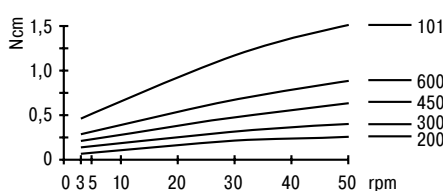

FRT-G2 (at 20 rpm)

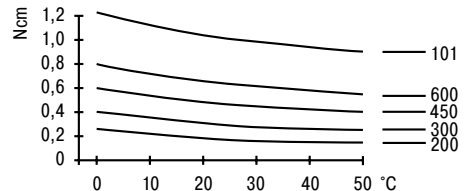

¹ A 250 mm long plastic rack is available for use with this part see page 124.

Damping in both Directions of Rotation

Without Gear	Nominal 20 rpm. 23 °C Damping Torque Ncm
FRT-G2-200	0.20 +/- 0.07
FRT-G2-300	0.30 +/- 0.08
FRT-G2-450	0.45 +/- 0.10
FRT-G2-600	0.60 +/- 0.12
FRT-G2-101	1.00 +/- 0.20

Damping in both Directions of Rotation

With Gear	Nominal 20 rpm. 23 °C Damping Torque Ncm
FRT-G2-200-G1	0.20 +/- 0.07
FRT-G2-300-G1	0.30 +/- 0.08
FRT-G2-450-G1	0.45 +/- 0.10
FRT-G2-600-G1	0.60 +/- 0.12
FRT-G2-101-G1	1.00 +/- 0.20

FRT-C2 and FRN-C2

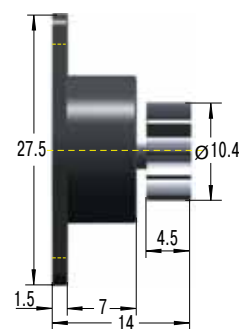
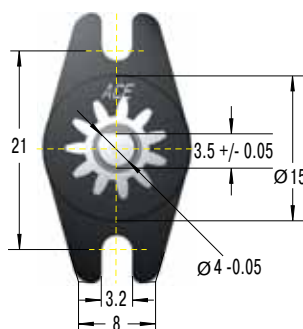

Technical Data

Pressure angle: 20°
Material: Polycarbonate plastic
Tooth: Involute
P.C.D.: 8.8 mm
No. of teeth: 11
Module: 1 0.8
Operating temperature range: 0 °C to 50 °C

FRT/N-C2 (at 23 °C)

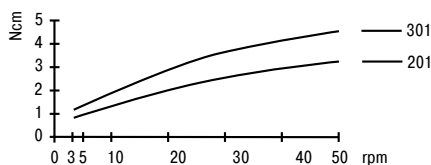

FRT/N-C2 (at 20 rpm)

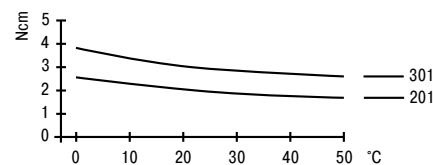

¹ A 170 mm long flexible plastic rack and a 250 mm long rigid rack are available for use with this part see page 124.

Bidirectional Damping	Right-Hand Damping (clockwise)	Left-Hand Damping (anti-clockwise)	Gear	Nominal 20 rpm, 23 °C	
				Damping Torque Ncm	
FRT-C2-201	FRN-C2-R201	FRN-C2-L201	without	2 +/- 0.6	
FRT-C2-201-G1	FRN-C2-R201-G1	FRN-C2-L201-G1	with	2 +/- 0.6	
FRT-C2-301	FRN-C2-R301	FRN-C2-L301	without	3 +/- 0.8	
FRT-C2-301-G1	FRN-C2-R301-G1	FRN-C2-L301-G1	with	3 +/- 0.8	

FRT-D2 and FRN-D2

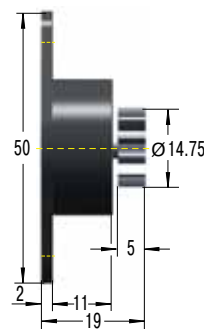
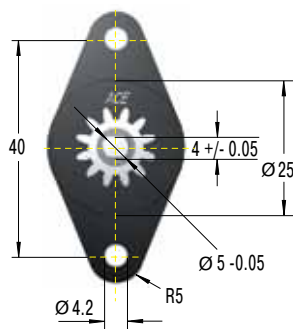

Technical Data

Pressure angle: 20°
Material: Polycarbonate plastic
Tooth: Involute
P.C.D.: 12 mm
No. of teeth: 12
Module: 1 1.0
Operating temperature range: 0 °C to 50 °C

FRT/N-D2 (at 23 °C)

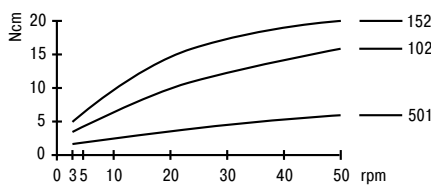

FRT/N-D2 (at 20 rpm)

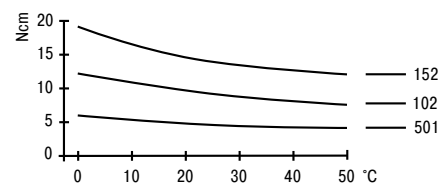

¹ A 250 mm and 500 mm long plastic rack are available for use with this part see page 124.

Bidirectional Damping	Right-Hand Damping (clockwise)	Left-Hand Damping (anti-clockwise)	Gear	Nominal 20 rpm, 23 °C	
				Damping Torque Ncm	
FRT-D2-102	FRN-D2-R102	FRN-D2-L102	without	10 +/- 2	
FRT-D2-102-G1	FRN-D2-R102-G1	FRN-D2-L102-G1	with	10 +/- 2	
FRT-D2-152	FRN-D2-R152	FRN-D2-L152	without	15 +/- 3	
FRT-D2-152-G1	FRN-D2-R152-G1	FRN-D2-L152-G1	with	15 +/- 3	
FRT-D2-501	FRN-D2-R501	FRN-D2-L501	without	5 +/- 1	
FRT-D2-501-G1	FRN-D2-R501-G1	FRN-D2-L501-G1	with	5 +/- 1	

Issue 7.2014. Specifications subject to change

FRT/FRN-K2 and FRT/FRN-F2

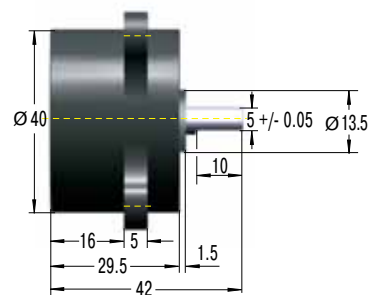
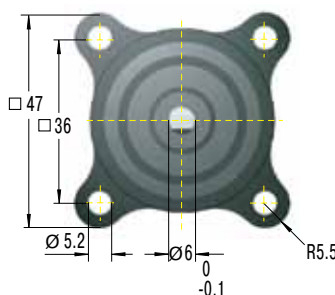

Technical Data

Max. weight: 0.116 kg
Material: Polycarbonate plastic, steel shaft
Operating temperature range: 0 °C to 50 °C

FRT-K2 and -F2 (at 23 °C)

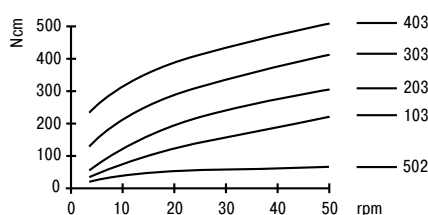

FRT-K2 and -F2 (at 20 rpm)

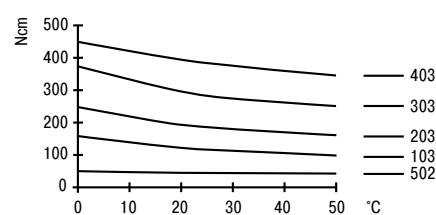

Bidirectional Damping	Right-Hand Damping (clockwise)	Left-Hand Damping (anti-clockwise)	Nominal 20 rpm, 23 °C
			Damping Torque Ncm
FRT-K2-502	FRN-K2-R502	FRN-K2-L502	50 +/- 10
FRT-K2-103	FRN-K2-R103	FRN-K2-L103	100 +/- 20
FRT-F2-203	FRN-F2-R203	FRN-F2-L203	200 +/- 40
FRT-F2-303	-	-	300 +/- 80
FRT-F2-403	-	-	400 +/- 100

FFD

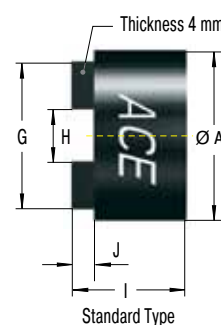
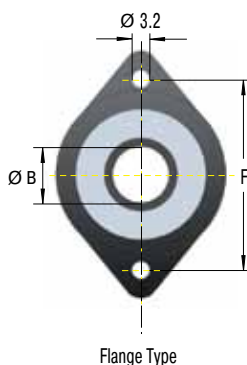
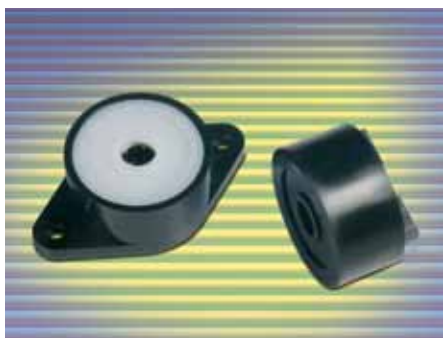

Technical Data

Material: Polycarbonate plastic
Rotational speed max.: 30 rpm
Cycle rate max.: 13 cycles per minute
Operating temperature range: -10 °C to 60 °C
Recommended shaft details: $\varnothing^{+0}_{-0.03}$ Hardness > HRC55, surface smoothness $R_z < 1 \mu\text{m}$

Ordering Example

Friction Damper _____
 Body \varnothing _____
 Mounting Style (flange = F, standard = S) _____
 Model (standard = S, high = W) _____
 Damping Direction (right = R, left = L) _____
 Damping Torque see chart _____

FFD-25-FS-L-102

Damping Torque

102 = 0.1 Nm
 502 = 0.5 Nm
 103 = 1.0 Nm
 153 = 1.5 Nm
 203 = 2.0 Nm
 253 = 2.5 Nm
 303 = 3.0 Nm

Type	Damping Torque Nm	Model	Dimensions		Flange Type				Standard Type			
			A	B	C	D	E	F	G	H	I	J
FFD-25	0.1/0.5/1.0	Type S	25	6	13	3	42	34	21	6.2	16	4
FFD-28	0.1/0.5/1.0	Type S	28	8	13	3	44	36	24	8.2	16	4
FFD-30	0.1/0.5/1.0/1.5	Type S	30	10	13	3	46	38	26	10.2	16	4
FFD-25	1.0/1.5/2.0	Type W	25	6	19	3	42	34	21	6.2	22	4
FFD-28	1.0/1.5/2.0	Type W	28	8	19	3	44	36	24	8.2	22	4
FFD-30	1.5/2.0/2.5/3.0	Type W	30	10	19	3	46	38	26	10.2	22	4

¹ Type W for a higher damping torque. Please note dimension C.

FDT-47 to 70

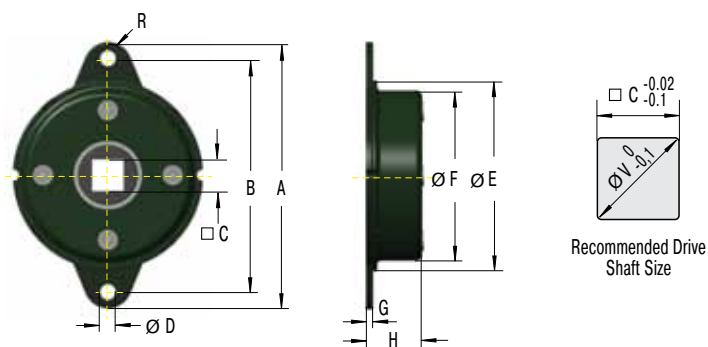

Technical Data

Max. weight: 0.11 kg
Material: Steel. Output shaft sleeve: Nylon
Rotational speed max.: 50 rpm
Cycle rate max.: 12 cycles per minute
Operating temperature range: -10 °C to 50 °C

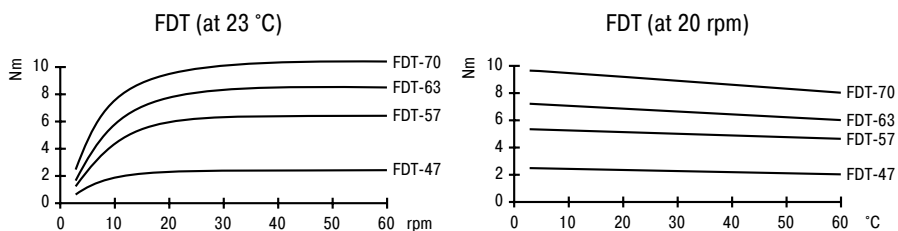

There is no support for the output shaft within the damper structure. External support must be provided for the shaft.

Damping in both Directions of Rotation

Type	at 20 rpm, 23 °C Damping Torque Nm	Dimensions									
		A	B	C	D	E	F	G	H	R	V
FDT-47	2.0 +/- 0.3	65	56	8	4.5	47	42.8	1.6	10.3	4.5	10
FDT-57	4.7 +/- 0.5	79	68	10	5.5	57	52.4	1.6	11.2	5.5	13
FDT-63	6.7 +/- 0.7	89	76	12.5	6.5	63	58.6	1.6	11.3	6.5	17
FDT-70	8.7 +/- 0.8	95	82	12.5	6.5	70	65.4	1.6	11.3	6.5	17

FDN-47 to 70

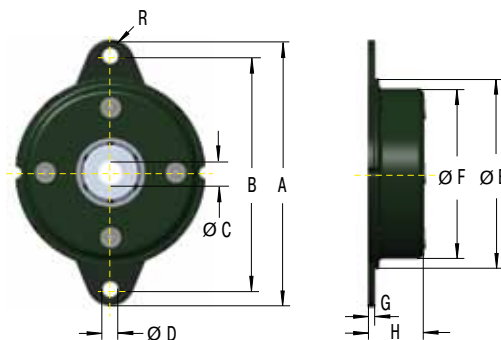

Technical Data

Max. weight: 0.12 kg
Material: Steel. Output shaft sleeve: Nylon
Rotational speed max.: 50 rpm
Cycle rate max.: 12 cycles per minute
Operating temperature range: -10 °C to 50 °C

There is no support for the output shaft within the damper structure. External support must be provided for the shaft.

Recommended shaft details:

for FDN-47: $\text{Ø } 6^{+0}_{-0.03}$

for FDN-57 to FDN-70: $\text{Ø } 10^{+0}_{-0.03}$

Hardness > HRC55, surface smoothness $R_z < 1 \mu\text{m}$

Right-Hand Damping (clockwise)	Left-Hand Damping (anti-clockwise)	at 20 rpm, 23 °C Damping Torque Nm	Dimensions									
			A	B	C	D	E	F	G	H	R	
FDN-47-R	FDN-47-L	2.0 +/- 0.3	65	56	6	4.5	47	42.8	1.6	10.3	4.5	
FDN-57-R	FDN-57-L	5.5 +/- 0.3	79	68	10	5.5	57	52.4	1.6	14	5.5	
FDN-63-R	FDN-63-L	8.5 +/- 0.8	89	76	10	6.5	63	58.6	1.6	13.9	6.5	
FDN-70-R	FDN-70-L	11.0 +/- 1.0	95	82	10	6.5	70	65.4	1.6	13	6.5	

ACE rotary dampers are maintenance-free and ready to install. The damping direction of the rotary dampers with partial rotation angle can have clockwise or counter clockwise damping. The outer bodies are of plastic or die-cast zinc. Rotary dampers with partial rotation angle allow the controlled opening and closing of small hoods, covers or flaps. They can be fitted directly at the point of rotation, in order to produce a smooth and even movement. Sensitive components remain unstressed. The harmonious gentle movement process enhances the quality and value of the product. Particularly suitable for flaps, covers and covering hoods for such items as printers or photocopiers, toilet seat covers, the furniture industry etc.

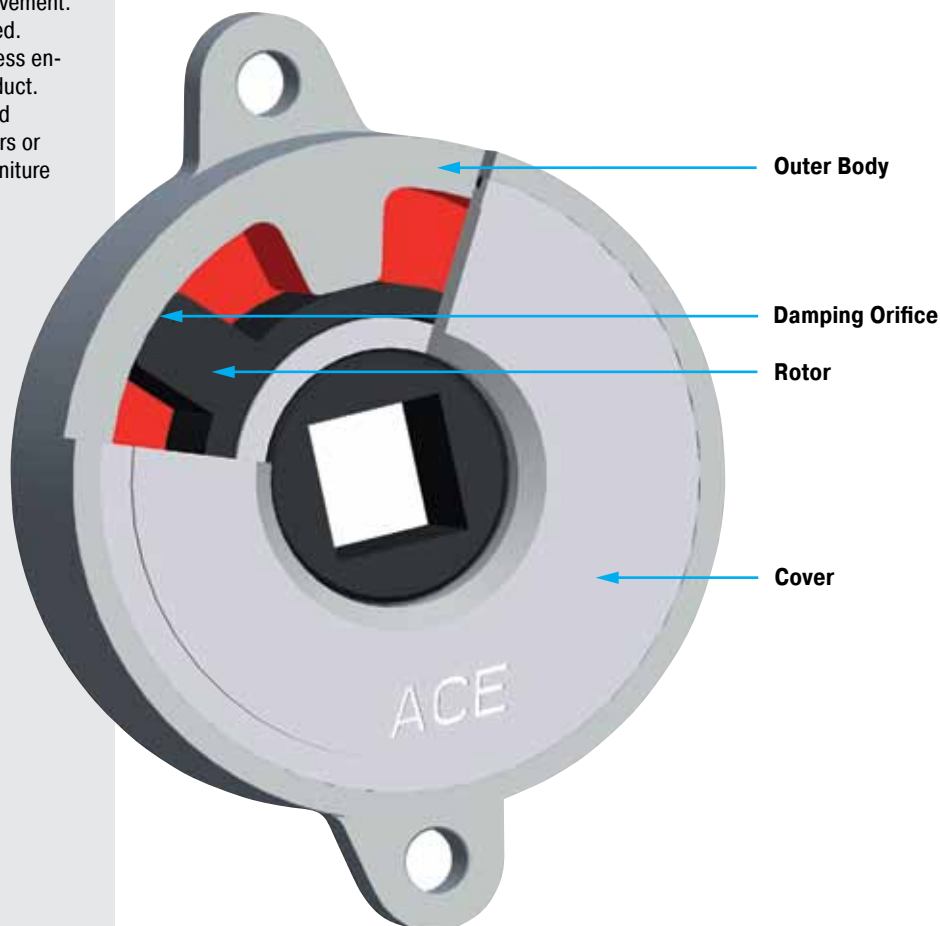

Function: In rotary dampers with partial rotation angle, the fluid is forced from one chamber into the other by the movement of a rotor. The damping moment is determined by the viscosity of the fluid and the dimensioning of the throttle gap or throttle orifices. During the relevant return movement, a certain reduced reverse rotation damping moment is created, depending on the size. The damping moments specified in the catalogue always refer to the maximum moment calculated from the application to which the dampers can be stressed.

Note: In general, ACE rotary dampers are tested for a service life of 50 000 cycles. Even after this time, the dampers still produce over approx. 80% of their original damping moment. The service life may be significantly higher or lower, depending on the application. Much higher service lives have however been achieved in practice.



FYN-P1

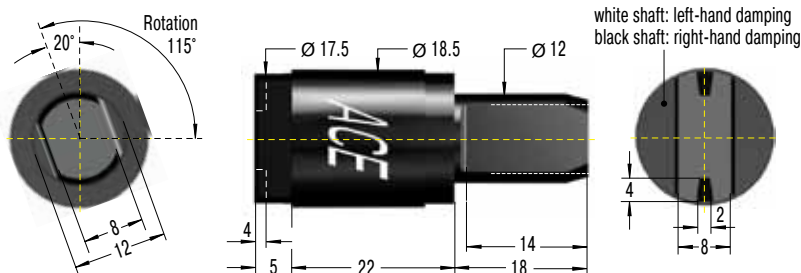

Technical Data

Weight: 0.010 kg
Material: Polycarbonate plastic
Max. rotation angle: 115 °
Operating temperature range: -5 °C to 50 °C

"Coloured shaft for identification of the damping direction!"



A play of approx. 5° can occur at the beginning of movement.
 Do not use damper as final end stop. Fit external mechanical stops at each end of travel.

Right-Hand Damping (clockwise)	Left-Hand Damping (anti-clockwise)	Damping Torque Ncm	Return Damping Torque Ncm
FYN-P1-R103	FYN-P1-L103	100	30
FYN-P1-R153	FYN-P1-L153	150	50
FYN-P1-R183	FYN-P1-L183	180	80

FYN-N1

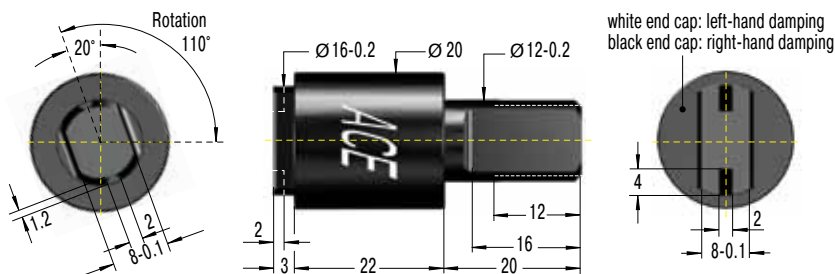

Technical Data

Weight: 0.012 kg
Material: Polycarbonate plastic
Max. rotation angle: 110 °
Operating temperature range: -5 °C to 50 °C

"Coloured end cap for identification of the damping direction!"



A play of approx. 5° can occur at the beginning of movement.
 Do not use damper as final end stop. Fit external mechanical stops at each end of travel.

Right-Hand Damping (clockwise)	Left-Hand Damping (anti-clockwise)	Damping Torque Ncm	Return Damping Torque Ncm
FYN-N1-R103	FYN-N1-L103	100	20
FYN-N1-R203	FYN-N1-L203	200	40
FYN-N1-R253	FYN-N1-L253	250	40
FYN-N1-R303	FYN-N1-L303	300	80

FYN-U1

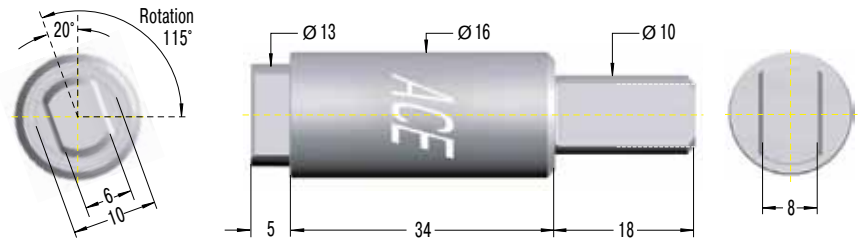

Technical Data

Weight: 0.04 kg
Material: Zinc die-cast
Max. rotation angle: 115 °
Operating temperature range: -5 °C to 50 °C

A play of approx. 5° can occur at the beginning of movement.
 Do not use damper as final end stop. Fit external mechanical stops at each end of travel.

Right-Hand Damping (clockwise)	Left-Hand Damping (anti-clockwise)	Damping Torque Ncm	Return Damping Torque Ncm
FYN-U1-R203	FYN-U1-L203	200	40
FYN-U1-R253	FYN-U1-L253	250	40
FYN-U1-R303	FYN-U1-L303	300	80

FYN-S1

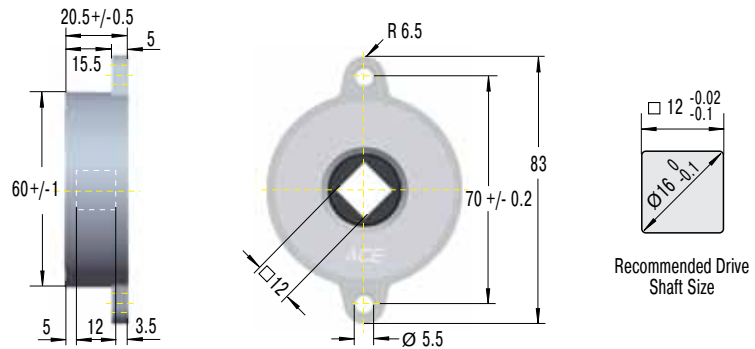
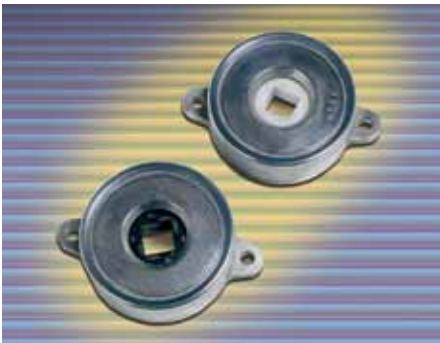

Technical Data

Weight: 0.22 kg
Material: Zinc die-cast.
 Output shaft sleeve:
 Plastic
Max. rotation angle: 130 °
Return damping torque: 1.5 Nm
Operating temperature range: -5 °C to 50 °C

A play of approx. 5° can occur at the beginning of movement.
 Do not use damper as final end stop. Fit external mechanical stops at each end of travel.

"Self-Compensating – constant motion with different masses!"



Right-Hand Damping (clockwise)	Self-Compensating Damping Torque Nm	Left-Hand Damping (anti-clockwise)	Self-Compensating Damping Torque Nm
FYN-S1-R104	5 - 10	FYN-S1-L104	5 - 10

Issue 7.2014. Specifications subject to change

ACE rotary dampers are maintenance-free and ready to install. The damping direction of the adjustable rotary dampers with partial rotation angle can be clockwise, counter clockwise or both. The outer bodies are of die-cast zinc, and the shafts of steel. The dampers ensure the controlled opening and closing of hoods, covers or flaps. They can damp directly at the rotation point or by transmission via a pinion, in order to produce a smooth and even movement. Sensitive components remain unstressed. The harmonious gentle movement process enhances the quality and value of the product. Particularly suitable for flaps, covers, closing hoods for such items as printers and photocopiers, the furniture industry etc.

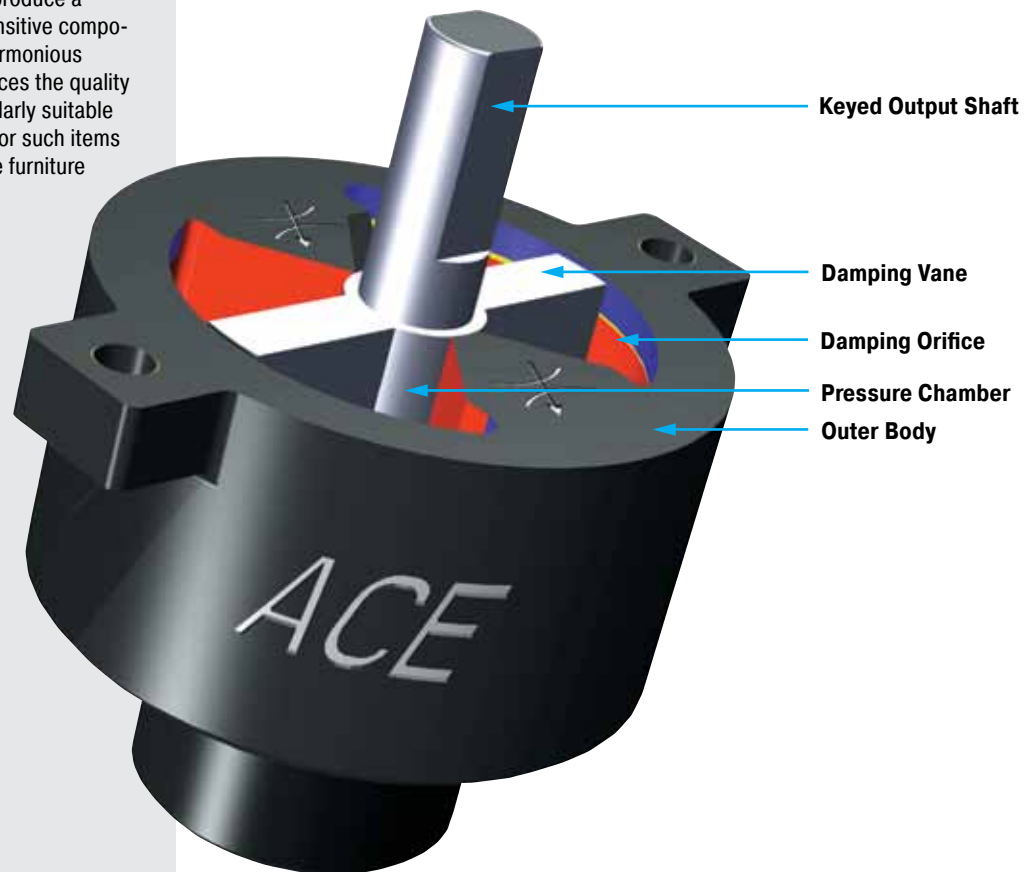

Function: In adjustable rotary dampers with partial rotation angle, the fluid is forced from one chamber into the other by adjustable orifices. The damping moment is determined by the viscosity of the fluid and the dimensioning of the orifice sizes. During the return movement of unidirectional dampers a small reverse damping moment is created, depending on the size. The damping moments specified in the catalogue always refer to the maximum moment calculated from the application to which the dampers can be stressed.

Note: In general, ACE rotary dampers are tested for a service life of 50 000 cycles. Even after this time, the dampers still produce over approx. 80% of their original damping moment. The service life may be significantly higher or lower, depending on the application. Much higher service lives have however been achieved in practice.

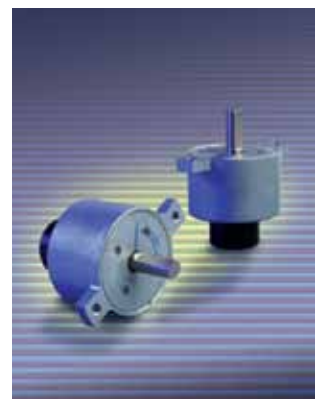

FYT-H1 and FYN-H1

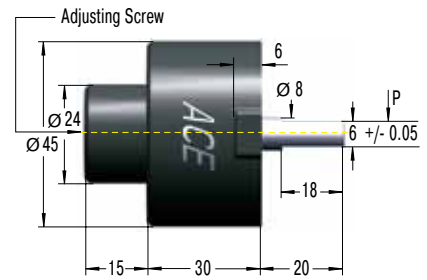
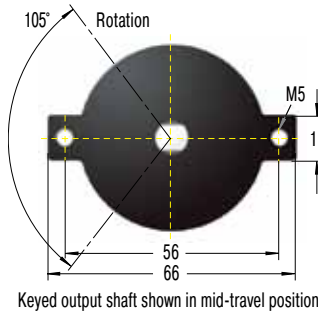
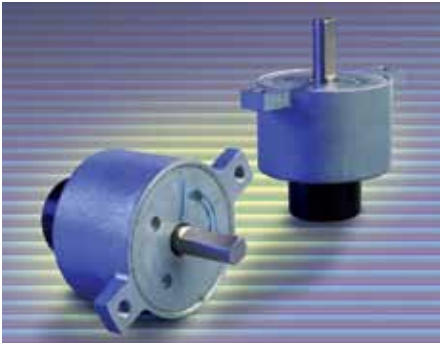

Technical Data

Weight: 0.24 kg
Material: Zinc die-cast, steel shaft
Max. rotation angle: 105 °
Maximum side load: 50 N
Return damping torque: 0.5 Nm
Operating temperature range: -5 °C to 50 °C

A play of approx. 5° can occur at the beginning of movement.

Do not use damper as final end stop. Fit external mechanical stops at each end of travel.

Model Adjustable	
	Adjustable
Bidirectional Damping	Damping Torque Nm
FYT-H1	2 - 10

Model Adjustable	
	Adjustable
Right-Hand Damping (clockwise)	Damping Torque Nm
FYN-H1-R	2 - 10

Model Adjustable	
	Adjustable
Left-Hand Damping (anti-clockwise)	Damping Torque Nm
FYN-H1-L	2 - 10

FYT-LA3 and FYN-LA3

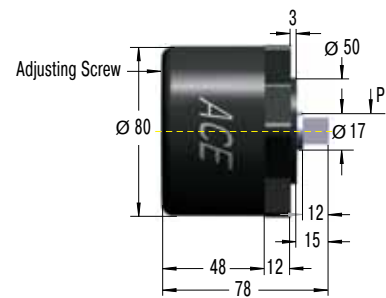
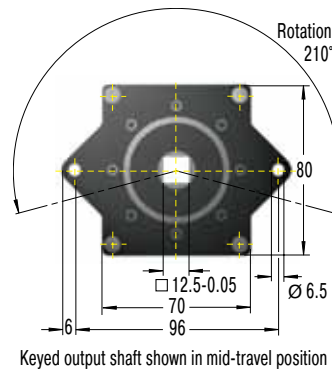
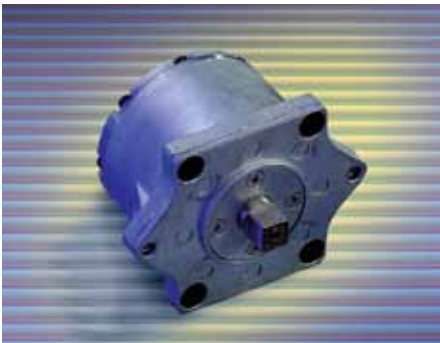

Technical Data

Weight: 1.75 kg
Material: Zinc die-cast, steel shaft
Max. rotation angle: 210 °
Maximum side load: 200 N
Return damping torque: 4 Nm
Operating temperature range: -5 °C to 50 °C

A play of approx. 5° can occur at the beginning of movement.

Do not use damper as final end stop. Fit external mechanical stops at each end of travel.

Model Adjustable	
	Adjustable
Bidirectional Damping	Damping Torque Nm
FYT-LA3	4 - 40

Model Adjustable	
	Adjustable
Right-Hand Damping (clockwise)	Damping Torque Nm
FYN-LA3-R	4 - 40

Model Adjustable	
	Adjustable
Left-Hand Damping (anti-clockwise)	Damping Torque Nm
FYN-LA3-L	4 - 40

Calculation of Rotary Damper for a Lid

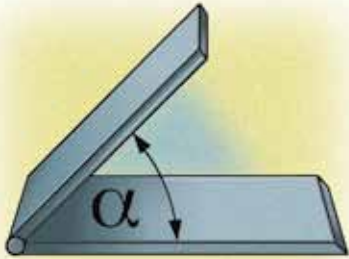

Closing Torque T

$$M = L / 2 \cdot m \cdot \cos \alpha$$

Note: for a uniform lid assume centre of gravity is at distance L / 2 from pivot.

- m Mass of a lid (kg)
- L Length of lid from pivot (cm)
- n Rotation speed (r.p.m.)

Calculation Steps

- 1) Calculate max. torque damper will be exposed to (with example shown max. torque is at $\alpha = 0$).
- 2) Decide upon rotation speed desired.
- 3) Choose a rotary damper from catalogue that can handle the torque calculated above.
- 4) With the aid of the damper performance curves, check if the r.p.m. given at your torque corresponds to the desired closing speed of the lid.
- 5) If the r.p.m. is too high – choose a damper with a higher torque rating.
If the r.p.m. is too low – choose a damper with a lower torque rating.

Mountings to Avoid

The output shaft should **not** be exposed to side loading.



Side loading



End loading



Angular offset



Misalignment

Toothed Rack M0.5, M0.6, M0.8, M1.0

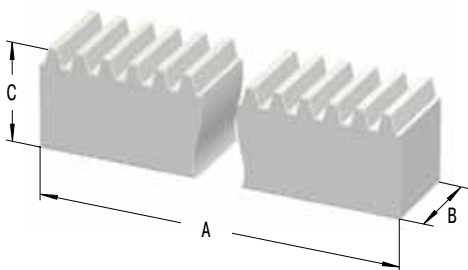

Toothed Rack M0.8P

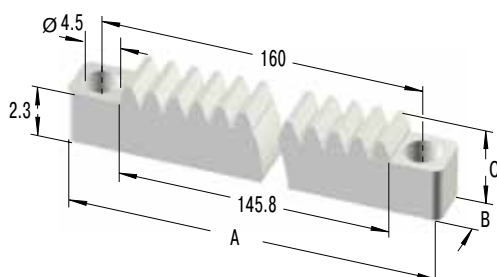

Damping Direction

right hand damping = damping action in clockwise direction when looking onto the output shaft

Accessories

Toothed plastic rack with modules 0.5 to 1.0 available.

Models Available

Type	A	B	C	Model
M0.5	250	4	4.5	rigid, milled
M0.6	250	4	6	rigid, milled
M0.8	250	6	8	rigid, milled
M0.8P	170	8	4.1	flexible, milled
M1.0	250	9	9	rigid, milled
M1.0	500	10	10	rigid, milled

Metal racks available on request.



Even rhythm

ACE rotary dampers ensure the quiet shuffling of playing cards. Software controlled playing card shuffling machines such as this one are used throughout the world and are equipped with the **FRT-G2-101-G1** type rotary dampers. Maintenance-free and ready to install. Before inserting the set of cards, you can ensure the quiet stopping of the plastic wedge in the equipment when it is driven upwards. The dampers can be applied to suit your requirements; clockwise, anticlockwise or in both directions; and they are just as reliable as the open and close slides in high quality DVD or CD players.



one2six is a trademark and copyright of Shuffle Master, Inc.

Playing cards are shuffled simply and quietly

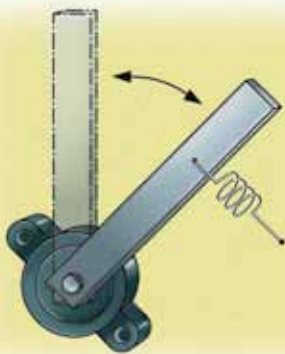

Damping lever motions

ACE rotary dampers protect the keyboard.

To provide long term protection in arduous and often dirty industrial applications (and also to protect against unauthorised access) the machine keyboard is installed in a lockable and pivoted housing cabinet.

ACE rotary dampers type **FRN-F1** were installed on the pivot axis to provide a smooth controlled motion to the keyboard as it is pulled down into its operating position. The damper also prevents overloading the hinge system and prevents damage to the keyboard, the housing cabinet and the hinges.



Pivoted machine keyboard

VC precision feed controls are sealed hydraulic units fitted with a high precision metering element. When the piston rod is depressed the hydraulic oil is forced through the adjustable precision metering orifice. This provides a constant and precise feed control throughout the stroke length. The feed rate can be adjusted over a wide range by turning the external adjuster knob at the rear end of the unit. The threaded outer body makes installation and the adjustment of feed control travel limits very simple. **FA, MA and MVC** are similar feed control units intended for applications where the higher precision of the VC series is not required. Precision feed controls are self-contained, maintenance-free, temperature stable and stick-slip free. The rolling diaphragm seal of feed controls with a stroke up to 55 mm provides a leakproof sealed unit and also provides an integral accumulator for the oil displaced during operation. The high precision, adjustable metering system can provide accurate feed rates from as low as 12 mm/min with light propelling forces. Applications include saws, cutters, drill feeds, grinding and boring machines in the plastics, metal, wood and glass industries.

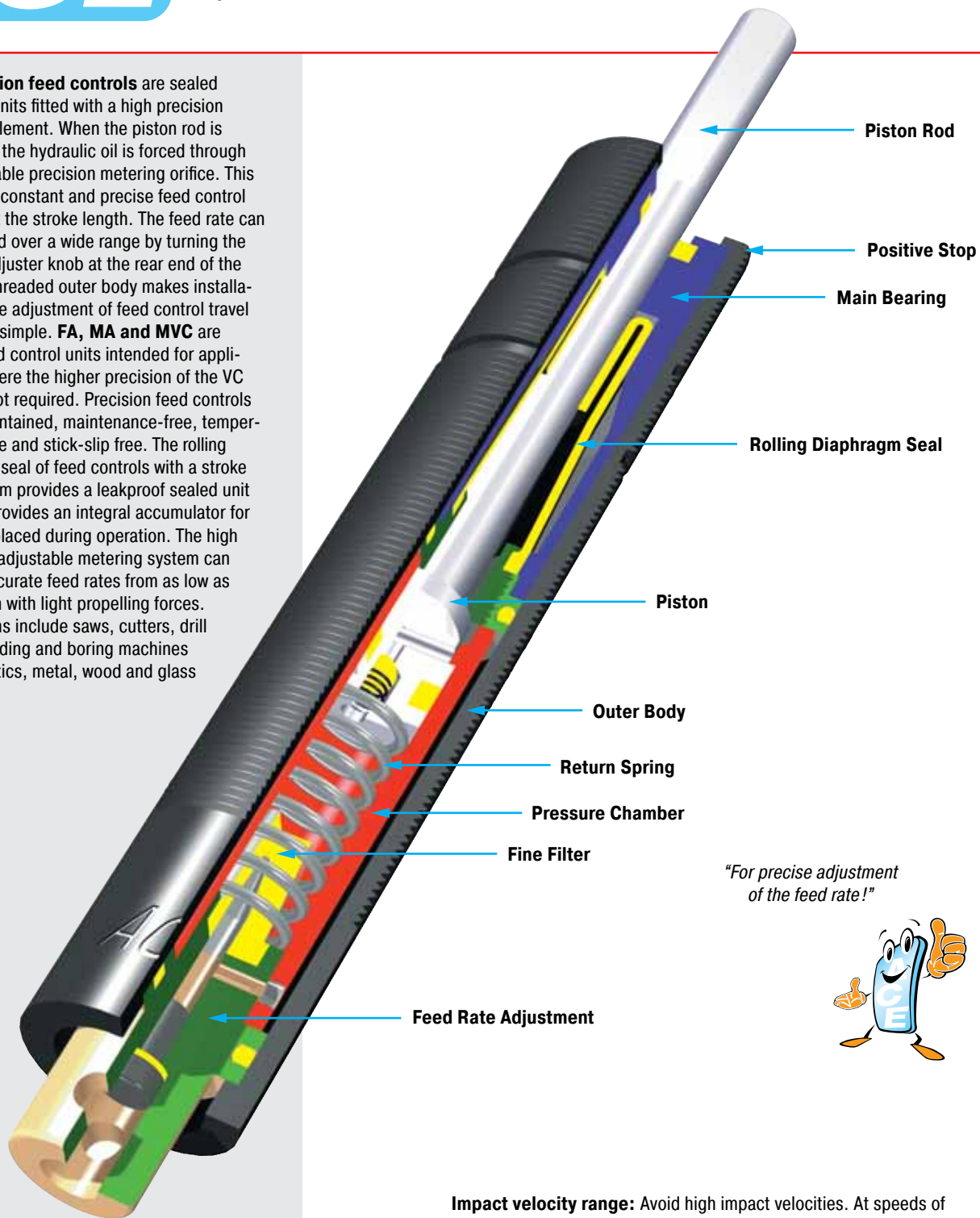

"For precise adjustment of the feed rate!"



Impact velocity range: Avoid high impact velocities. At speeds of 0.3 m/s the maximum allowed energy is approx. 1 Nm for units up to 55 mm stroke and approx. 2 Nm for units 75 mm to 125 mm stroke. Where higher energies occur use a shock absorber for the initial impact.

Material: Body: Black anodized aluminum. Piston rod: Hard chrome plated.

Nylon button PP600 can be fitted onto piston rod. Unit may be mounted in any position.

When mounting: Take care not to damage the adjuster knob.

Operating temperature range: 0 °C to 60 °C

Only VC2515 to VC2555: Do not rotate piston rod, if excessive rotation force is applied rolling seal may rupture. In contact with petroleum base oils or cutting fluids specify optional neoprene rolling seal or install air bleed adaptor type SP.



VC25

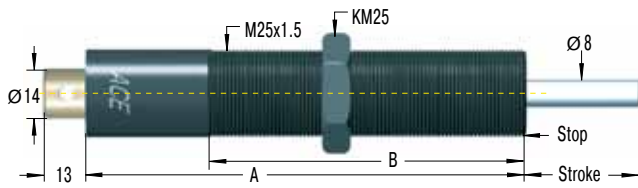

SP25

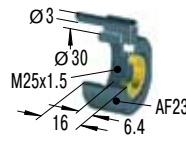

Air Bleed Collar

for VC2515FT to VC2555FT
reduction of the stroke 6.4 mm

MB25

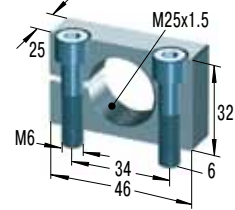

Clamp Mount

Accessories, mounting, installation ... see pages 36 to 39.

Capacity Chart

Type Part Number	Stroke mm	A	B	Min. Propelling Force N	Max. Propelling Force N	Min. Return Force N	Max. Return Force N	Rod Reset Time s	Max. Side Load Angle °	Weight kg
VC2515FT	15	128	80	30	3 500	15	30	0.2	3	0.35
VC2530FT	30	161	110	30	3 500	5	30	0.4	2	0.45
VC2555FT	55	209	130	35	3 500	5	40	1.2	2	0.6
VC2575FT	75	283	150	50	3 500	10	50	1.7	2	0.681
VC2510FT	100	308	150	60	3 500	10	50	2.3	1	0.794
VC25125FT	125	333.5	150	70	3 500	10	60	2.8	1	0.908

Suffix "FT" signifies a M25x1.5 threaded body.

Suffix "F" signifies a plain body 23.8 mm dia. (without thread) also available, with optional clamp type mounting block.

Technical Data

Outer body: Plain body 23.8 mm dia. (without thread) is also available.

Feed rate range: Min. 0.013 m/min with 400 N propelling force, max. 38 m/min with 3500 N propelling force.

Mounting Examples



Mounting with clamp mount MB25



Installed with air bleed collar SP25

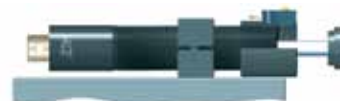

Installed with switch stop collar inc. proximity switch and steel button AS25 plus PS25

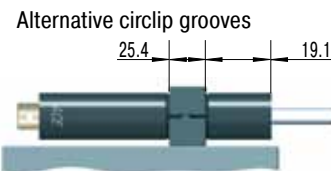

Bulkhead mounting for VC25...F with mounting block KB... (23.8 mm plain body option)

Operating Range VC

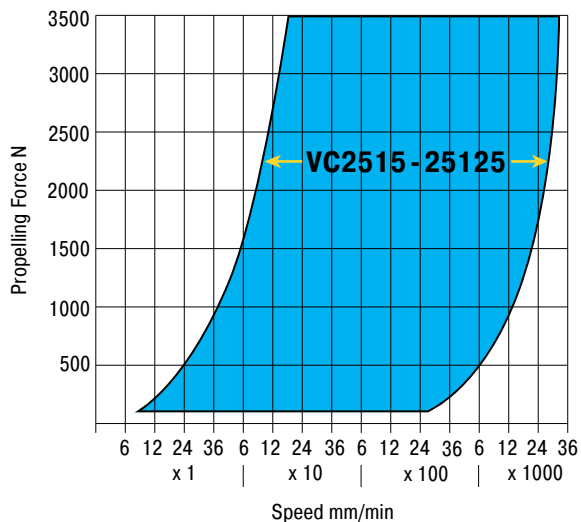

MA30M

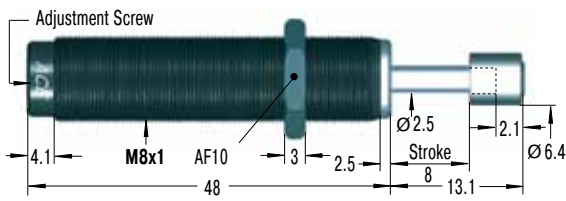

Accessories, mounting, installation ... see pages 34 to 39.

MA50M for use on new installations

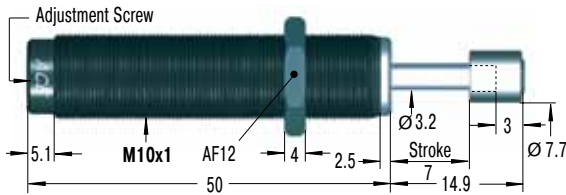

Accessories, mounting, installation ... see pages 34 to 39.

MA35M

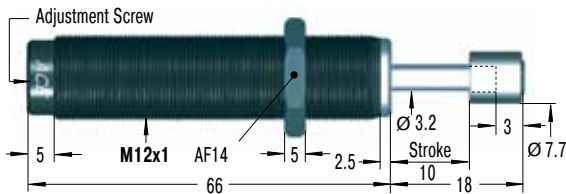

Accessories, mounting, installation ... see pages 35 to 39.

MA150M

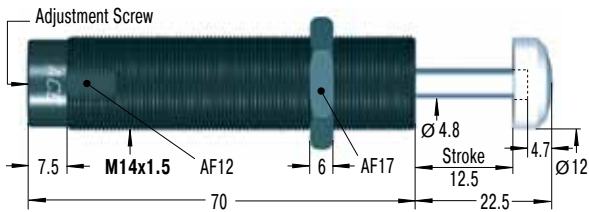

M14x1 also available to special order

Accessories, mounting, installation ... see pages 35 to 39.

MVC225M

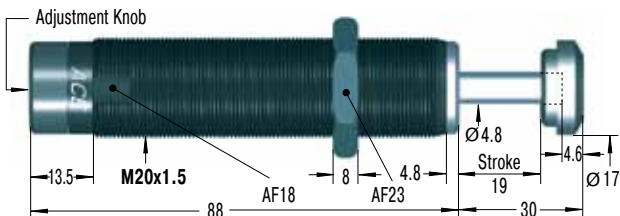

Accessories, mounting, installation ... see pages 36 to 39.

MVC600M and MVC900M

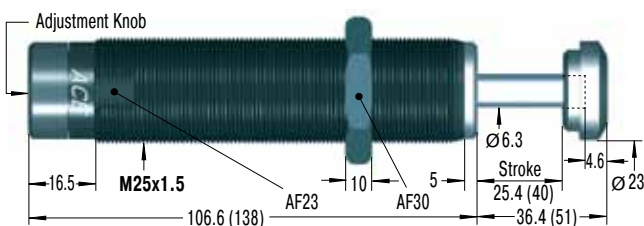

Dimensions for MVC900M in ()

Accessories, mounting, installation ... see pages 36 to 39.

RF8

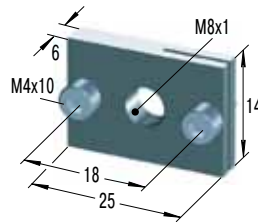

Rectangular Flange

MB8SC2

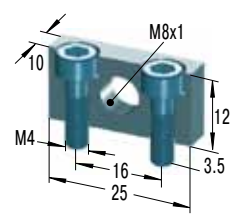

Mounting Block

FA1008V-B still available in future

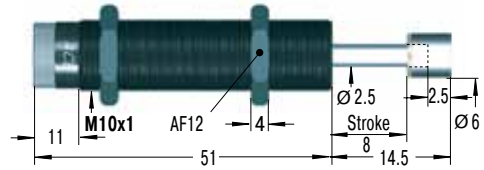

Accessories, mounting, installation ... see pages 34 to 39.

RF12

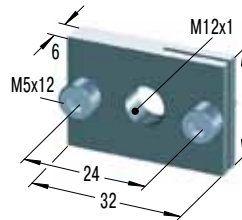

Rectangular Flange

MB12

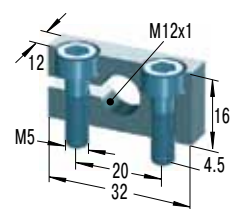

Clamp Mount

RF14

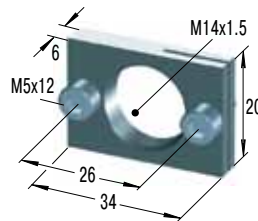

Rectangular Flange

MB14

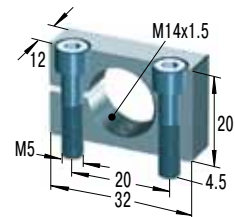

Clamp Mount

RF20

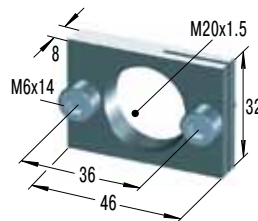

Rectangular Flange

MB20

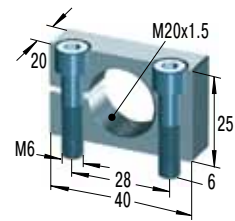

Clamp Mount

RF25

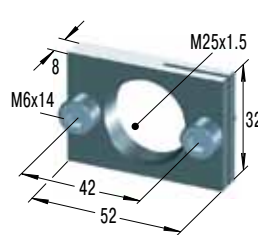

Rectangular Flange

MB25

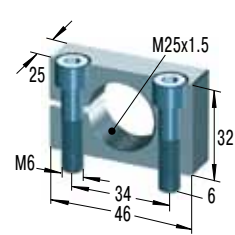

Clamp Mount

Capacity Chart

Type Part Number	Stroke mm	Propelling Force N		Min. Return Force N	Max. Return Force N	Rod Reset Time s	1 Max. Side Load Angle °	Weight kg
		min. N	max. N					
MA30M	8	8	80	1.7	5.3	0.3	2	0.013
MA50M	7	40	160	3	6	0.3	2	0.025
FA1008V-B	8	10	180	3	6	0.3	2.5	0.024
MA35M	10	15	200	5	11	0.2	2	0.043
MA150M	12	20	300	3	5	0.4	2	0.06
MVC225M	19	25	1 750	5	10	0.65	2	0.15
MVC600M	25	65	3 500	10	30	0.85	2	0.3
MVC900M	40	70	3 500	10	35	0.95	2	0.4

¹ For applications with higher side load angles consider using the side load adaptor (BV) page 38.

Technical Data

Impact velocity range: Avoid high impact velocities. At speeds of 0.3 m/s the maximum allowed energy is approx. 2 Nm. Where higher energies occur use a shock absorber for the initial impact.

Mounting: In any position

Positive stop: Install mechanical stop 0.5 to 1 mm before end of stroke on model FA1008V-B.

Material: Body: Steel with black oxide finish. Piston rod: Stainless steel.

Operating temperature range: 0 °C to 66 °C

Operating Range MVC225 to 900

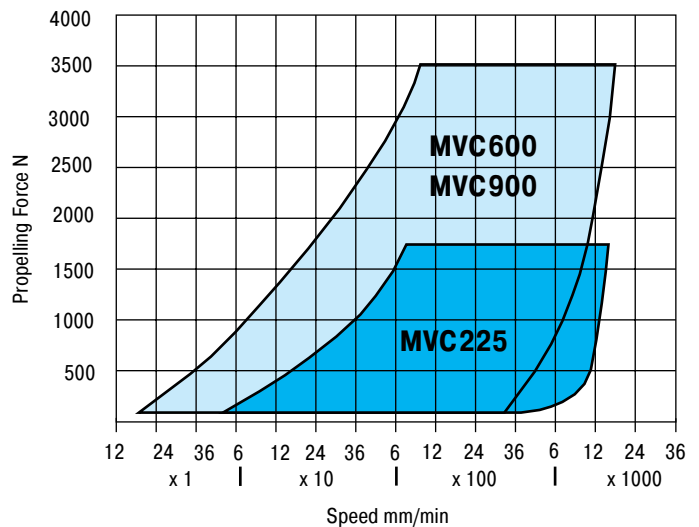

Application Examples

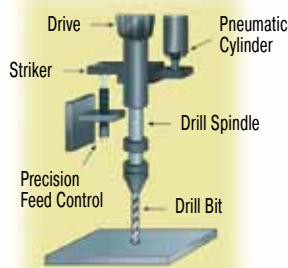

Drilling sheet metal

A high force is necessary at the start of drilling when the drill first contacts the sheet. After the initial cut this high force causes the drill to break through. This results in jagged edges rather than a smooth clean hole and also causes tool breakage.

By installing an **ACE VC feed control** it is possible to precisely control the rate of drill advance. As a result the drilled holes are clean and consistent and drill breakage is considerably reduced.

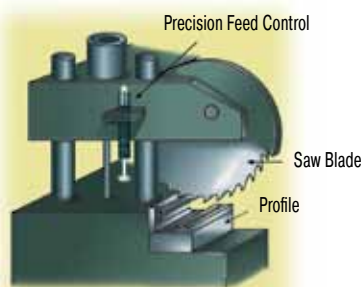

Sawing aluminium and plastic profiles

Varying material types, hardness and wear on the saw blade causes the cutting pressure to vary greatly. However the saw advance speed should remain constant as changes cause breakage of the material being cut or of the saw blade.

An **ACE VC feed control** fitted directly to the cutting head provides a simple and low cost solution. The cutting speed remains constant and can be easily preset.

Hydraulic speed/feed controls from ACE are maintenance-free, self-contained sealed units for precise control of speed in both directions of travel. The travel speed can be adjusted independently in each direction of travel. Applications include pick and place, machine slides and guards, flaps and hoods etc. The wide variety of mounting accessories make the DVC easy to install on many different types of application.

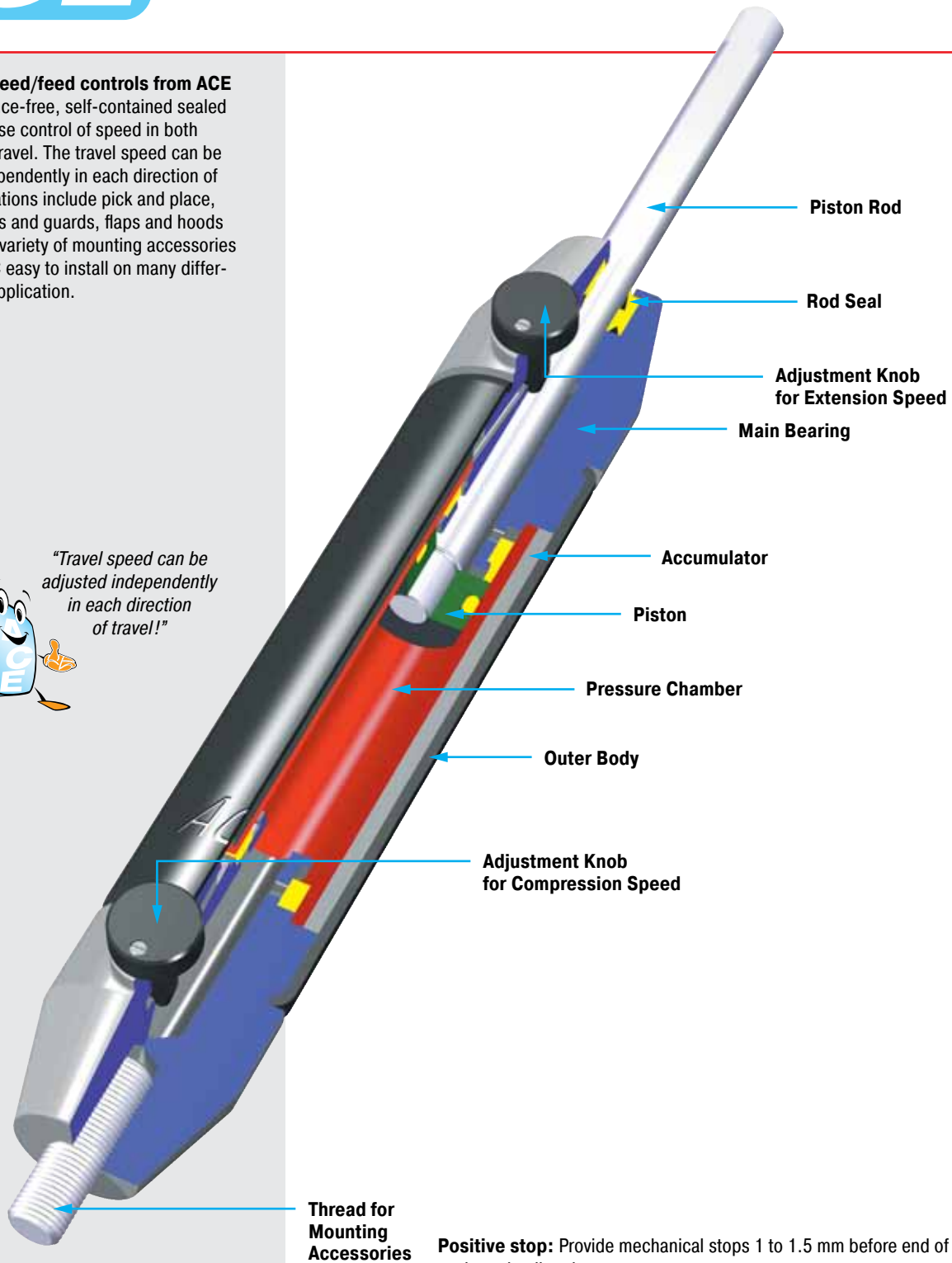
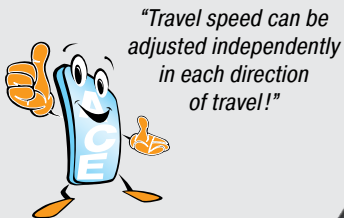

Positive stop: Provide mechanical stops 1 to 1.5 mm before end of each stroke direction.

Operating fluid: Automatic Transmission Fluid (ATF)

Material: Body: Black anodised aluminium. Piston rod: Hard chrome plated steel. End fittings: Zinc plated steel.

Note: If unit has not moved for some time the seals may dry causing an increased break-away force on the initial cycle.

Mounting: In any position. End fittings must be positively secured to prevent unscrewing.

Operating temperature range: 0 °C to 65 °C

On request: Special oils and external finishes. Uni-directional damping (free flow in reverse direction).



End Fitting

Standard Dimensions

End Fitting

A8

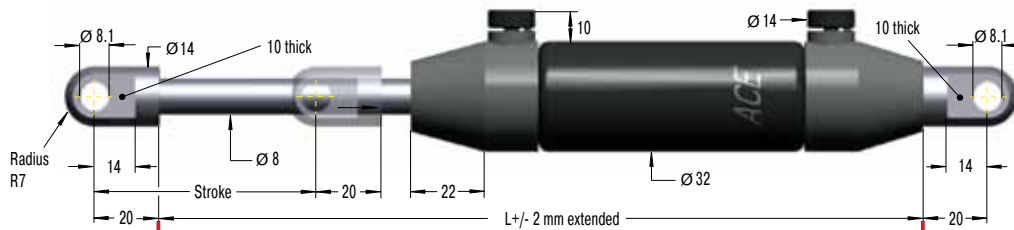

Eye A8
max. force 3000 N

B8



Dimensions

Type	Stroke mm	A max	B	L	Propelling Force N			
					Extension min	Extension max	Compression min	Compression max
DVC-32-50	50			240	42	2 000	42	2 000
DVC-32-50-XX	50	250	75.2		42	2 000	42	2 000
DVC-32-100	100			340	42	2 000	42	1 670
DVC-32-100-XX	100	350	124.4		42	2 000	42	1 670
DVC-32-150	150			440	42	2 000	42	1 335
DVC-32-150-XX	150	450	173.6		42	2 000	42	1 335

Stud Thread B8

C8

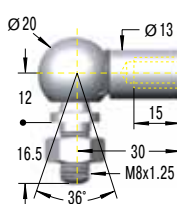

Angle Ball Joint C8
max. force 1200 N

D8

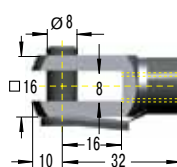

Clevis Fork D8
max. force 3000 N

E8

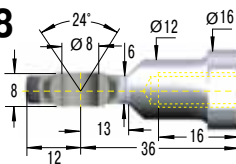

Swivel Eye E8
max. force 3000 N

Ordering Example

DVC-32-50-DD-P

Type (Hydraulic Damper) _____
 Body Ø (32 mm) _____
 Stroke (50 mm) _____
 Piston Rod End Fitting D8 _____
 Body End Fitting D8 _____
 Damping Direction (P = both directions) _____

Damping Options

- P = Damping in both directions (standard model)
- M = Damping on out stroke only (adjustment knob at "rear end" free flow)
- N = Damping on in stroke only (adjustment knob at "piston rod end" free flow)

The end fittings are interchangeable and must be positively secured by the customer to prevent unscrewing (i.e. Loctite). For mounting accessories see page 186.

Fixed End Fitting -XX

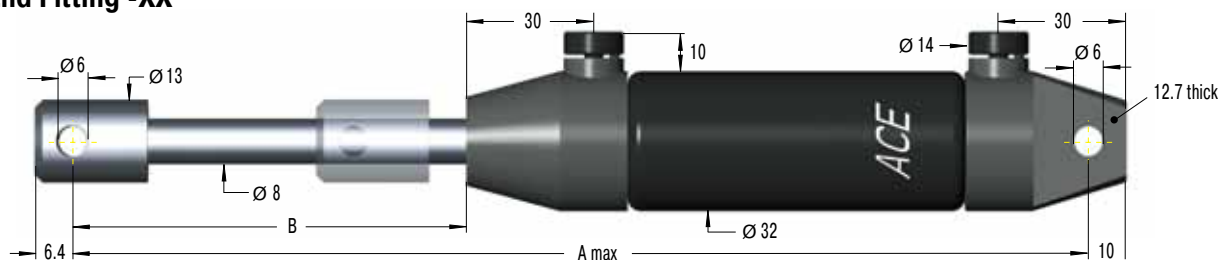

Compression Speed Control Chart

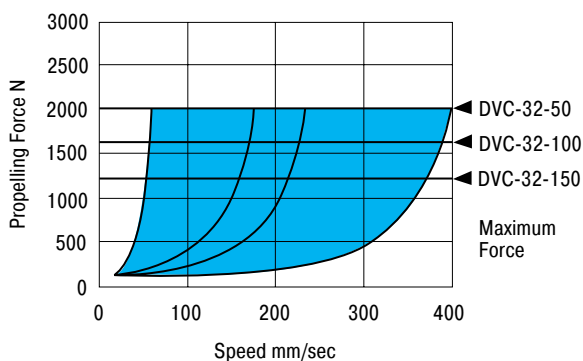

Tension Speed Control Chart

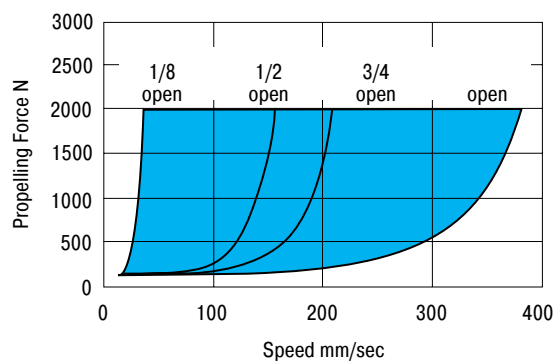

Hydraulic Dampers of ACE are maintenance-free, self contained sealed units, ready for use, for the precise control of damping in both directions of travel. The travel speed can be adjusted independently in each direction of travel at any time even during the stroke. The dampers are ideal for controlling swinging movements or as a variable resistance control on sports devices, exercise equipment and physiotherapy machines. Thanks to the new, high precision metering elements this damper ensures a constant feed rate independently controlled in each direction and the adjustment can be performed after mounting. The coated body and the steel-hardened and hard-chrome-plated piston rod stand for high quality and long lifetimes. The wide variety of mounting accessories make the **HBD** easy to install in many different types of applications.

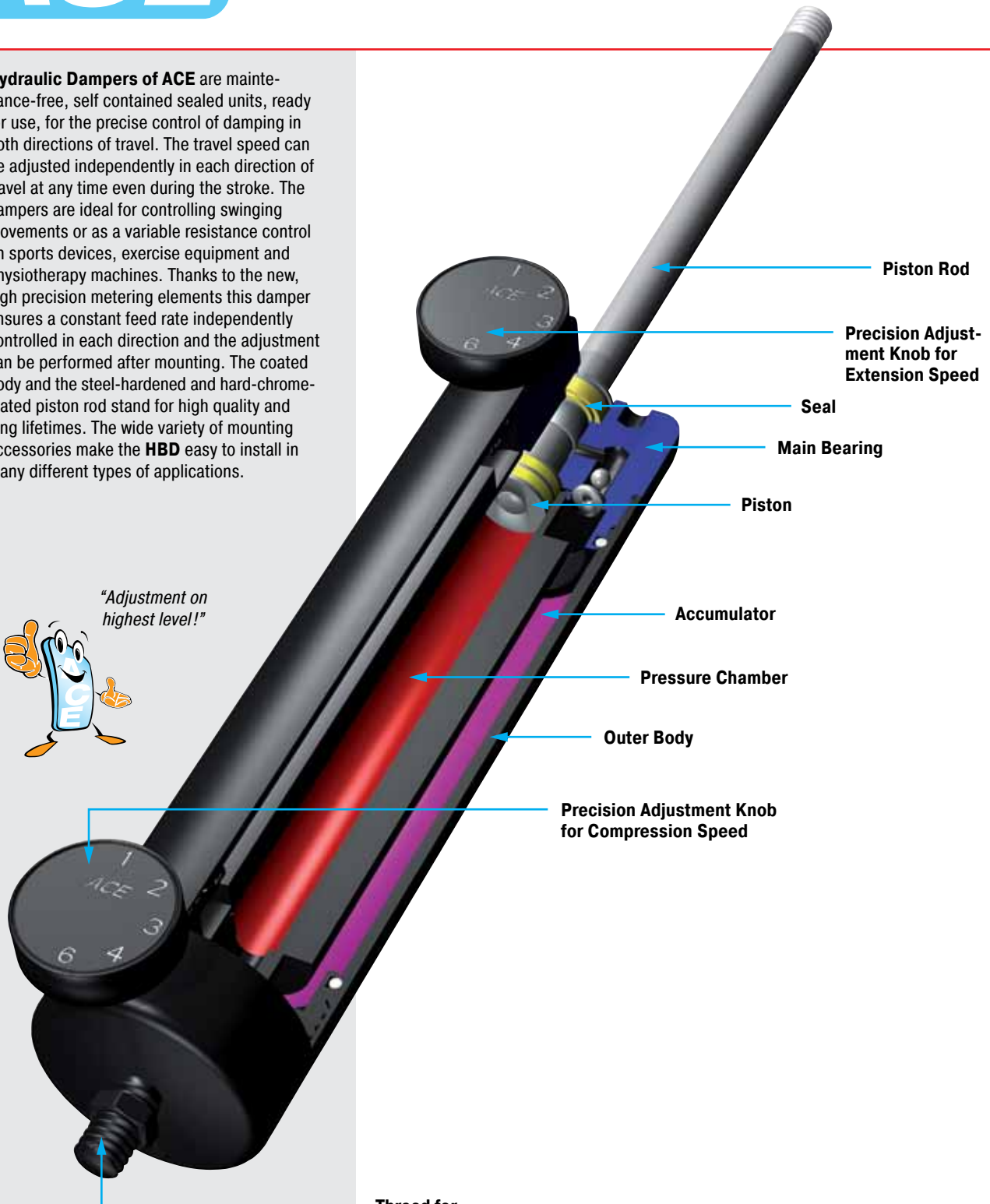

Thread for Mounting Accessories

Positive stop: Provide a mechanical stop of 1 to 1.5 mm before the end of stroke in each direction.

Material: Piston rod: Hard chrome plated steel. Body: Black coated steel.

Note: If unit has not moved for some time the seals may dry, causing an increased breakaway force on the initial cycle.

Mounting: In any position. End fittings must be positively secured to prevent unscrewing.

Operating temperature range: 0 °C to 65 °C

Maximum speed: 0.5 m/s

On request: Special lengths, stroke, alternative seals, end fittings and special oil.



End Fitting

Standard Dimensions

End Fitting

B14

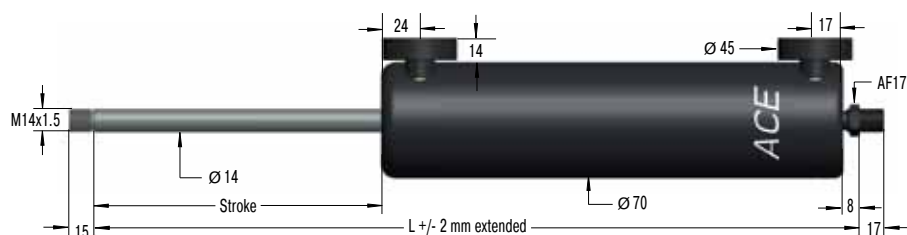

Stud Thread B14

A14

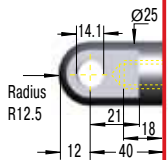

Eye A14
max. force 10 000 N

C14

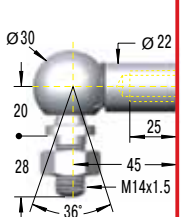

Angle Ball Joint C14
max. force 3200 N

D14

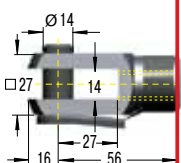

Clevis Fork D14
max. force 10 000 N

E14

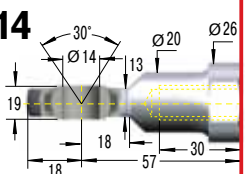

Swivel Eye E14
max. force 10 000 N

Dimensions

Type	Stroke mm	L extended	¹ Max. Compression Force N
HBD-70-100	100	314	10 000
HBD-70-150	150	414	10 000
HBD-70-200	200	514	10 000
HBD-70-300	300	714	10 000
HBD-70-400	400	914	8 000
HBD-70-500	500	1 114	6 000

¹ Max. extension force for all stroke lengths 10 000 N.

Ordering Example

HBD-70-300-EE

Type (Hydraulic Damper) _____
 Body Ø (70 mm) _____
 Stroke (300 mm) _____
 Piston Rod End Fitting E14 _____
 Body End Fitting E14 _____

Damping Option Separately Adjustable

- Damping on out stroke only
- Damping on in stroke only
- Damping in both directions

The end fittings are interchangeable and must be positively secured by the customer to prevent unscrewing (i.e. Loctite). For mounting accessories see page 187.

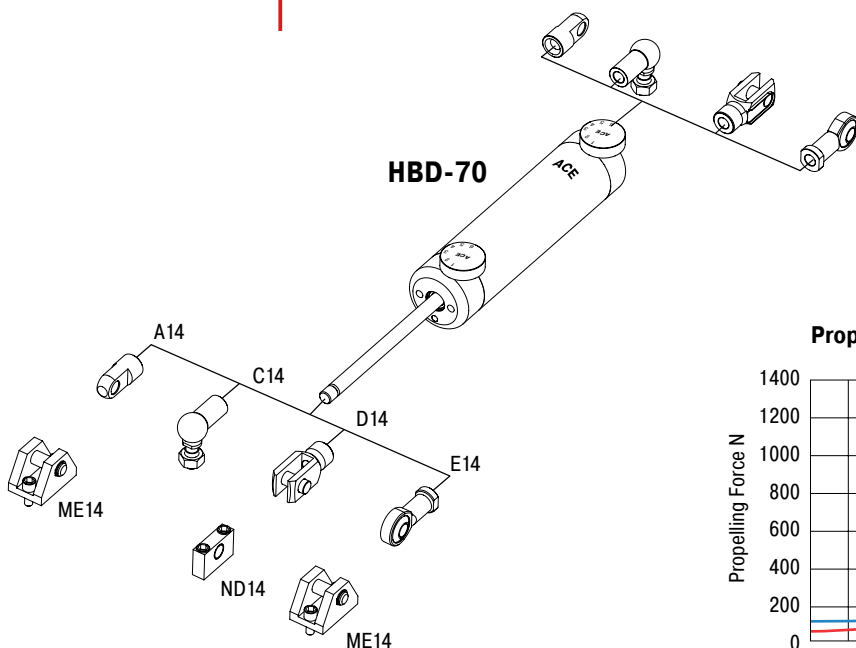

For mounting accessories see page 187.

Propelling Force at 12.5 mm/s

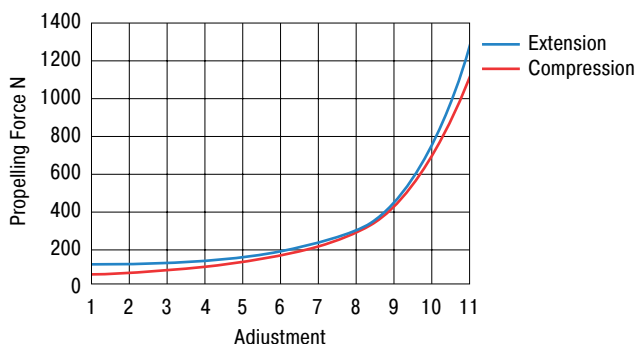

Hydraulic dampers from ACE are maintenance-free, self-contained and sealed units. They are available with body diameters from 28 mm up to 70 mm and with stroke lengths of up to 800 mm. As standard they are supplied as double acting dampers but a single acting version is also available. The single acting version is controllable in one direction only, with free flow in the opposite direction. The travel speed is adjustable and remains constant throughout the stroke. **The new adjustment segment on the piston makes sensitive speed adjustment easy.** ACE's hydraulic dampers sport the sleek design of our gas springs. **The zinc-plated outer body and the hard-chromed piston rod provide high quality and long life.** A wide range of screw on mounting accessories make them very versatile and easy to install. Typical applications include machine guards and lids, fire safety flaps and doors, damping oscillations of suspended loads (Power and Free Systems) etc. The stepless adjustment of the damping rate is achieved by pulling (or pushing) the piston rod to its fully extended (or compressed) position and then turning the piston rod.

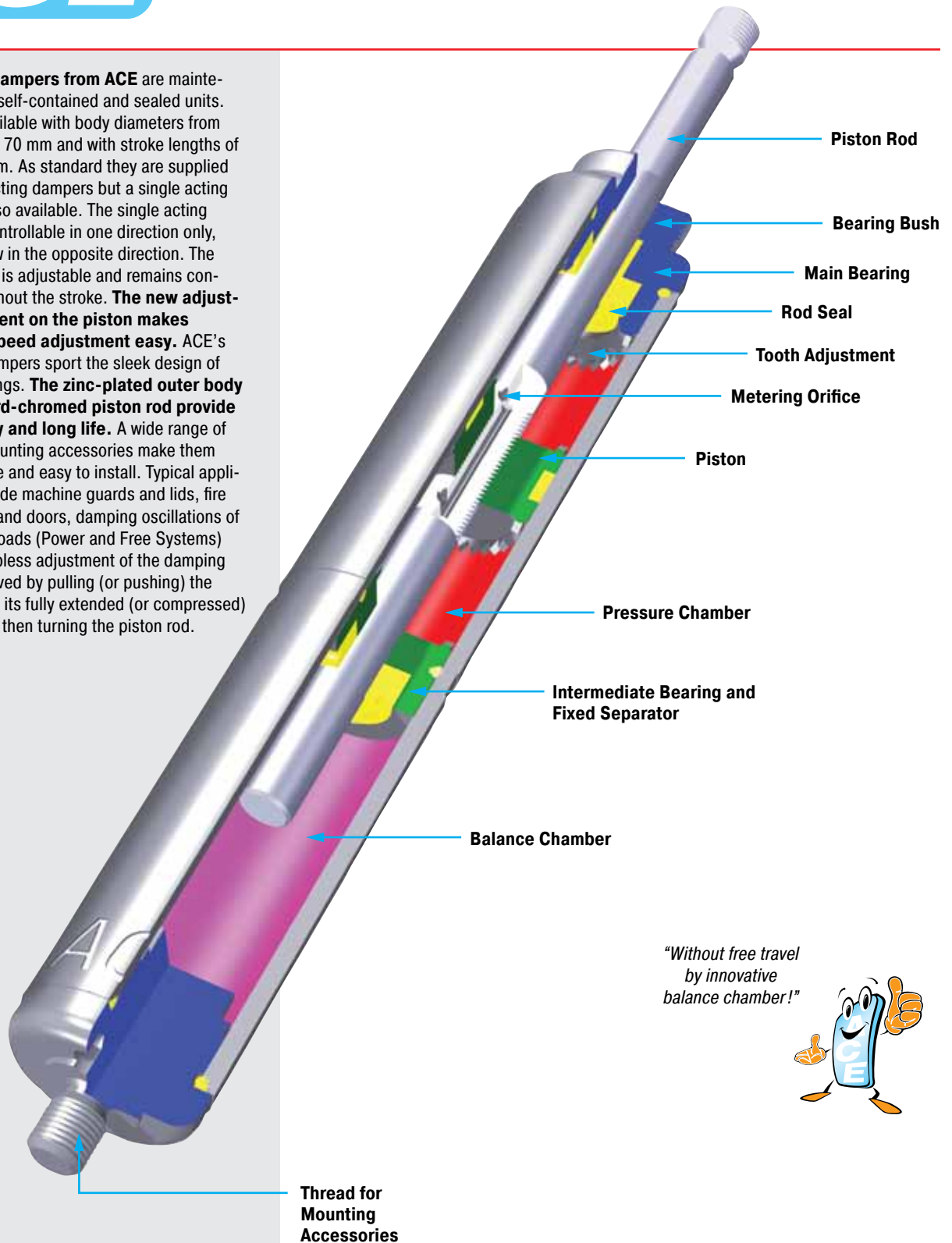

"Without free travel by innovative balance chamber!"



Operating fluid: Hydraulic oil

Note: If unit has not moved for some time the seals may dry, causing an increased breakaway force on the initial cycle.

Mounting: In any position. End fittings must be positively secured to prevent unscrewing.

Operating temperature range: -20 °C to 80 °C

On request: Special lengths, alternative seals and end fittings.



End Fitting

Standard Dimensions

End Fitting

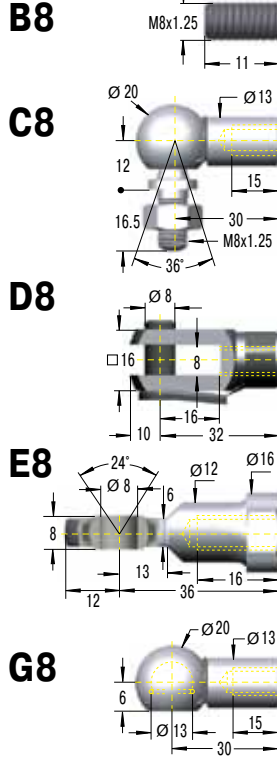
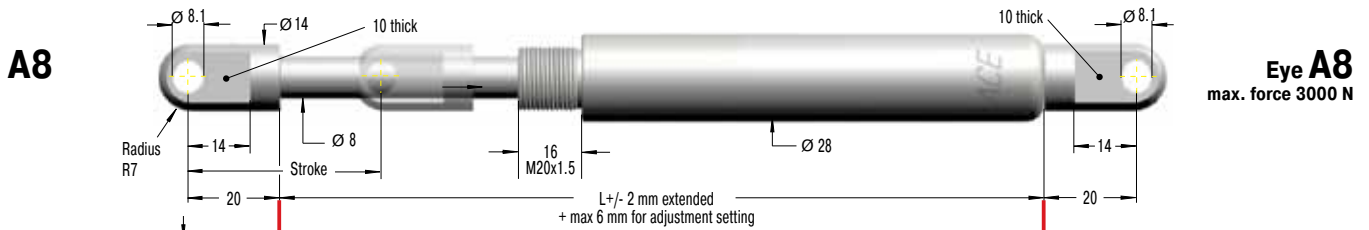

Dimensions					
Type	Stroke mm	L extended	¹ Max. Compression Force N	¹ Max. Compression Force with MBS N	
HBS-28-50	50	295	3 000	3 000	
HBS-28-100	100	445	1 550	3 000	
HBS-28-150	150	595	900	3 000	
HBS-28-200	200	745	600	3 000	
HBS-28-250	250	895	440	3 000	
HBS-28-300	300	1 045	330	3 000	
HBS-28-350	350	1 195	260	2 500	
HBS-28-400	400	1 345	200	2 000	

¹ Max. extension force for all stroke lengths 3000 N.

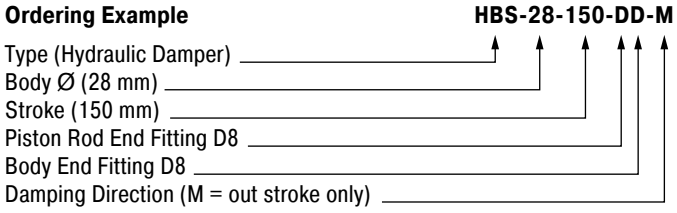

- Damping Options**
- P = Damping in both directions
 - N = Damping on in stroke only
 - M = Damping on out stroke only
 - X = Special model suffix

The end fittings are interchangeable and must be positively secured by the customer to prevent unscrewing (i.e. Loctite). For mounting accessories see page 186.

Swivel Mounting Block MBS-28

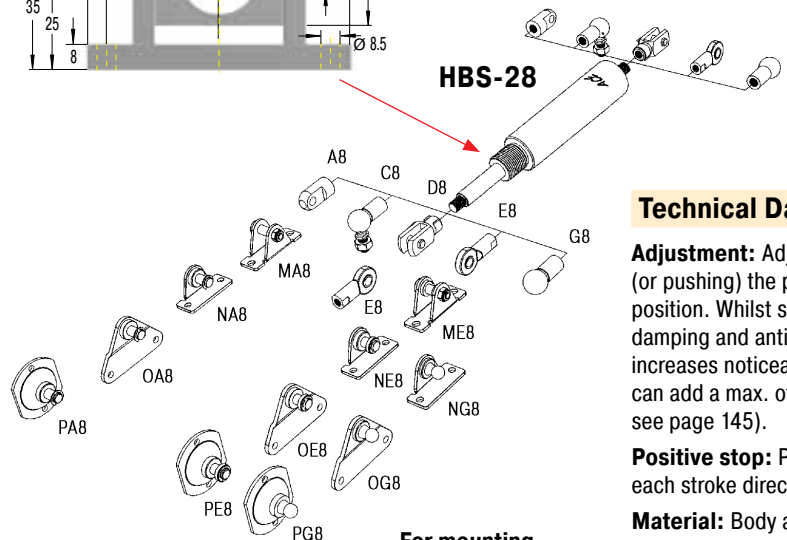
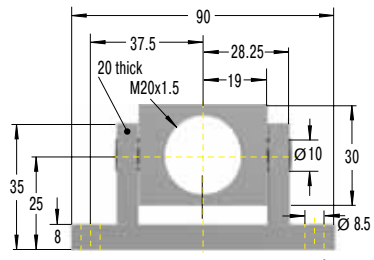

For mounting accessories see page 186.

Technical Data

Adjustment: Adjustment of the damping rate is achieved by pulling (or pushing) the piston rod to its fully extended (or compressed) position. Whilst still pulling the piston rod turn it clockwise to increase damping and anti-clockwise to decrease damping. If the resistance increases noticeably, stop adjusting to avoid damage. The adjustment can add a max. of 6 mm to the L dim. shown (adjustment instruction see page 145).

Positive stop: Provide mechanical stops 1 to 1.5 mm before end of each stroke direction.

Material: Body and end fittings: Zinc plated steel. Piston rod: Hard chrome plated.

Rod Shroud
no retrofit
Ø 32, L = Stroke + 50

End Fitting

Standard Dimensions

End Fitting

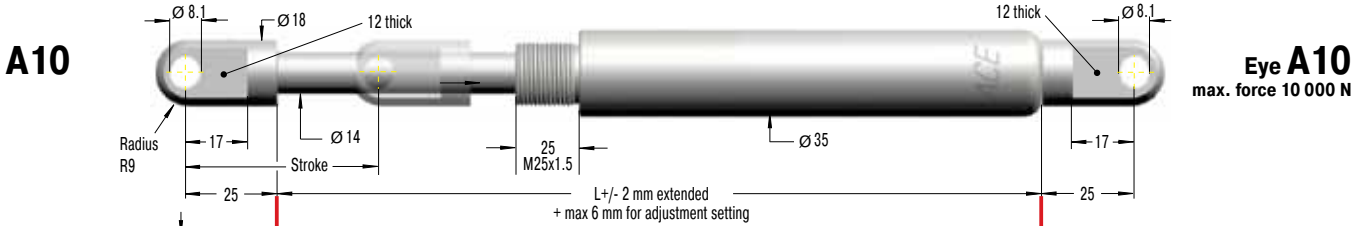

Dimensions

Type	Stroke mm	L extended	¹ Max. Compression Force N	¹ Max. Compression Force with MBS N
HBS-35-100	100	485	10 000	10 000
HBS-35-150	150	635	7 500	10 000
HBS-35-200	200	785	5 150	10 000
HBS-35-300	300	1 085	2 850	10 000
HBS-35-400	400	1 385	1 800	10 000
HBS-35-500	500	1 685	1 240	10 000
HBS-35-600	600	1 985	910	8 600
HBS-35-700	700	2 285	690	6 500
HBS-35-800	800	2 585	540	5 100

¹ Max. extension force for all stroke lengths 10 000 N.

Ordering Example

HBS-35-300-EE-N

Type (Hydraulic Damper) _____
 Body Ø (35 mm) _____
 Stroke (300 mm) _____
 Piston Rod End Fitting E10 _____
 Body End Fitting E10 _____
 Damping Direction (N = in stroke only) _____

Damping Options

- P = Damping in both directions
- N = Damping on in stroke only
- M = Damping on out stroke only
- X = Special model suffix

The end fittings are interchangeable and must be positively secured by the customer to prevent unscrewing (i.e. Loctite). For mounting accessories see page 186.

Swivel Mounting Block MBS-35

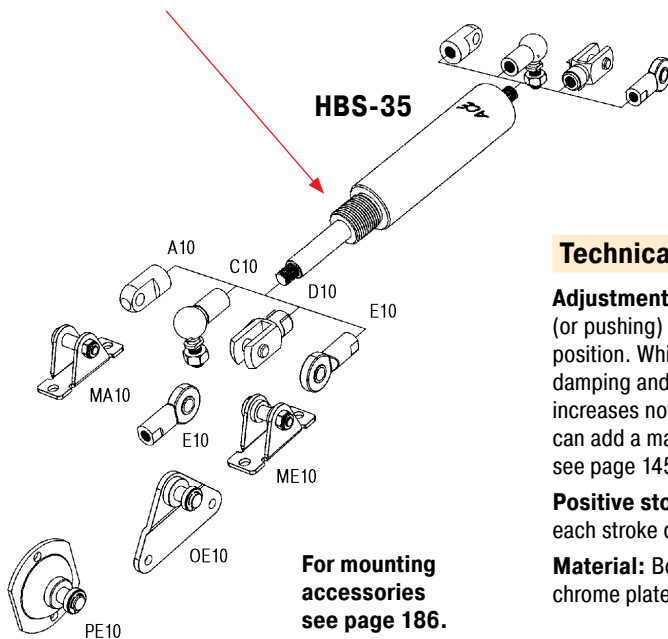
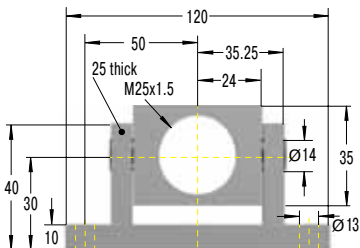

For mounting accessories see page 186.

Technical Data

Adjustment: Adjustment of the damping rate is achieved by pulling (or pushing) the piston rod to its fully extended (or compressed) position. Whilst still pulling the piston rod turn it clockwise to increase damping and anti-clockwise to decrease damping. If the resistance increases noticeably, stop adjusting to avoid damage. The adjustment can add a max. of 6 mm to the L dim. shown (adjustment instruction see page 145).

Positive stop: Provide mechanical stops 1 to 1.5 mm before end of each stroke direction.

Material: Body and end fittings: Zinc plated steel. Piston rod: Hard chrome plated.

End Fitting

Standard Dimensions

End Fitting

B24



Stud Thread B24

D24

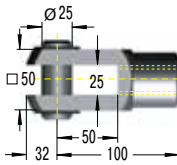

Clevis Fork D24
max. force 50 000 N

E24

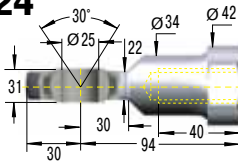

Swivel Eye E24
max. force 50 000 N

Swivel Mounting Block MBS-70

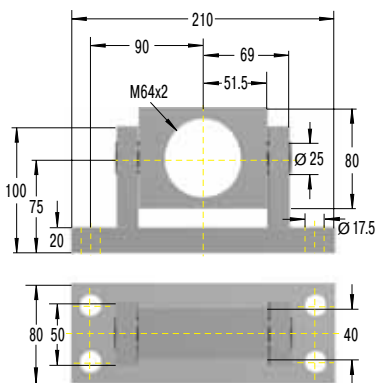

Dimensions

Type	Stroke mm	L extended	¹ Max. Compression Force N	¹ Max. Compression Force with MBS N
HBS-70-100	100	561	40 000	40 000
HBS-70-200	200	861	40 000	40 000
HBS-70-300	300	1 161	40 000	40 000
HBS-70-400	400	1 461	30 300	40 000
HBS-70-500	500	1 761	21 600	40 000
HBS-70-600	600	2 061	16 200	40 000
HBS-70-700	700	2 361	12 600	40 000
HBS-70-800	800	2 661	10 100	40 000

¹ Max. extension force for all stroke lengths 40 000 N.

Ordering Example

HBS-70-300-EE-N

Type (Hydraulic Damper) _____
 Body Ø (70 mm) _____
 Stroke (300 mm) _____
 Piston Rod End Fitting E24 _____
 Body End Fitting E24 _____
 Damping Direction (N = in stroke only) _____

Damping Options

- P = Damping in both directions
- N = Damping on in stroke only
- M = Damping on out stroke only
- X = Special model suffix

The end fittings are interchangeable and must be positively secured by the customer to prevent unscrewing (i.e. Loctite). For mounting accessories see page 187.

Rod Shroud W24-70
Ø 80, L = Stroke + 130

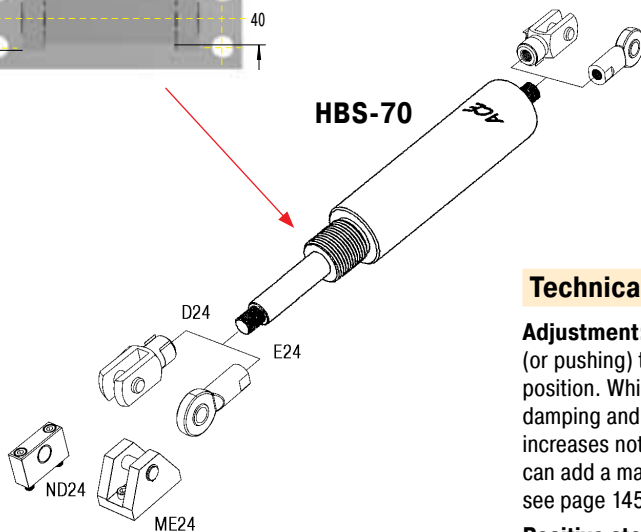

For mounting accessories see page 187.

Technical Data

Adjustment: Adjustment of the damping rate is achieved by pulling (or pushing) the piston rod to its fully extended (or compressed) position. Whilst still pulling the piston rod turn it clockwise to increase damping and anti-clockwise to decrease damping. If the resistance increases noticeably, stop adjusting to avoid damage. The adjustment can add a max. of 8 mm to the L dim. shown (adjustment instruction see page 145).

Positive stop: Provide mechanical stops 5 to 6 mm before end of each stroke direction.

Material: Body: Black powder coated steel or zinc plated steel. Piston rod: Hard chrome plated. End fittings: Zinc plated steel.

Hydraulic dampers from ACE are maintenance-free, self-contained and sealed units. They are available with body diameters from 12 mm up to 70 mm and with stroke lengths of up to 800 mm. As standard they are supplied as double acting dampers but a single acting version is also available. The single acting version is controllable in one direction only, with free flow in the opposite direction. The travel speed is adjustable and remains constant throughout the stroke. **The new adjustment segment on the piston makes sensitive speed adjustment easy.** ACE's hydraulic dampers sport the sleek design of our gas springs. **The coated body and the piston rod with a special wear-resistant coating provide an exceptionally long lifetime and excellent corrosion protection.** A wide range of screw on mounting accessories make them very versatile and easy to install. Typical applications include machine guards and lids, fire safety flaps and doors, damping oscillations of suspended loads (Power and Free Systems) etc.

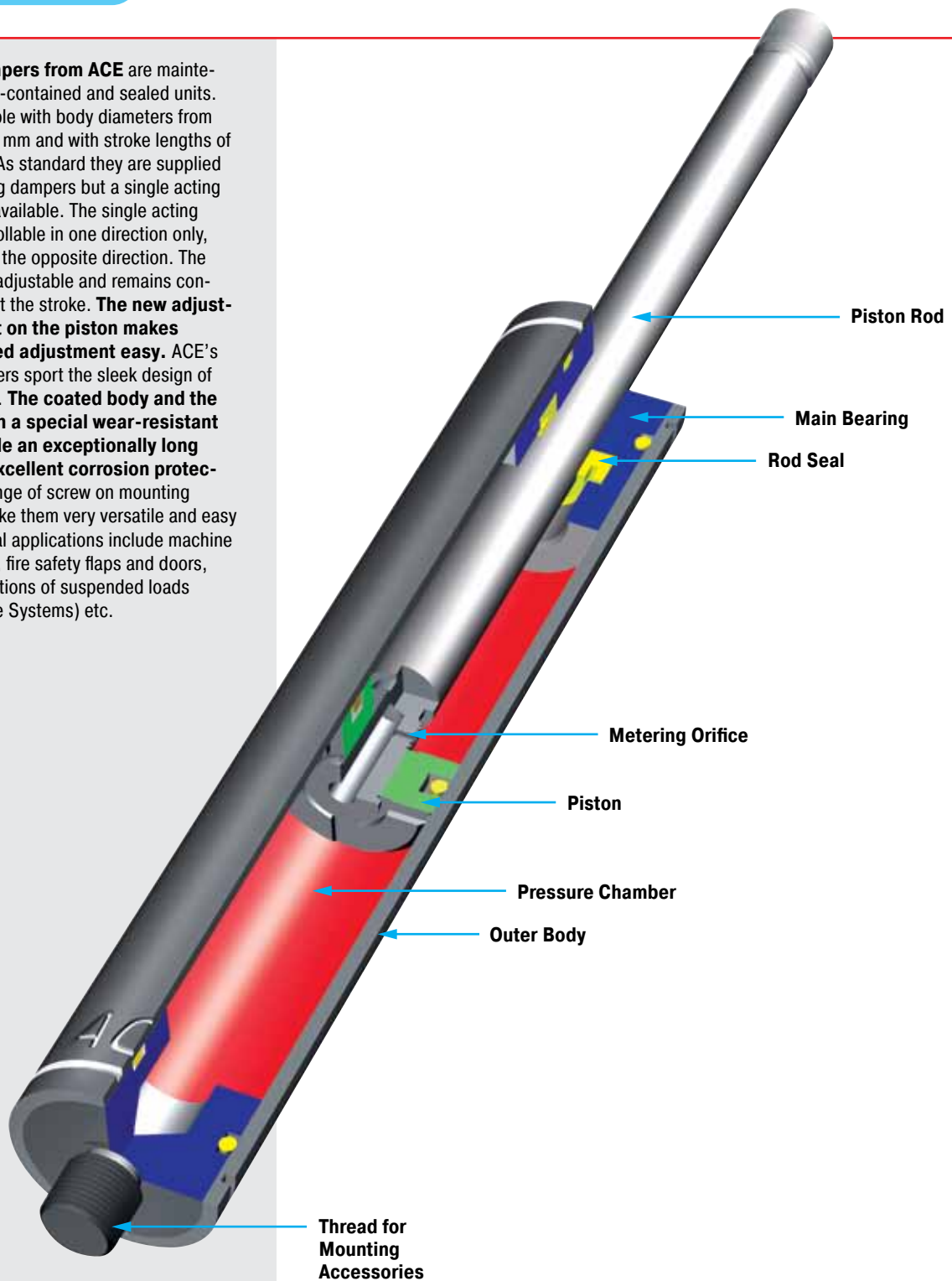

Function: The stepless adjustment of the damping rate is achieved by pulling (or pushing) the piston rod to its fully extended (or compressed) position and then turning the piston rod.

Operating fluid: Hydraulic oil

Mounting: In any position. End fittings must be positively secured to prevent unscrewing.

Operating temperature range: -20 °C to 80 °C

On request: Special lengths, alternative seals and end fittings.



End Fitting

Standard Dimensions

End Fitting

A3,5



Eye A3,5
max. force 370 N

B3,5



Stud Thread B3,5

C3,5

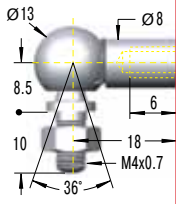

Angle Ball Joint C3,5
max. force 370 N

D3,5

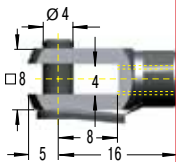

Clevis Fork D3,5
max. force 370 N

E3,5

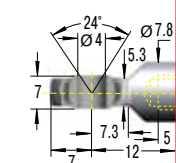

Swivel Eye E3,5
max. force 370 N

G3,5

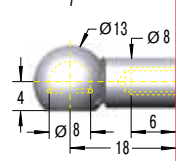

Ball Socket G3,5
max. force 370 N

Rod Shroud W3,5-12

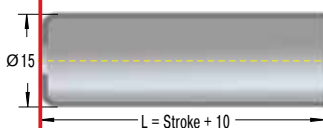

Dimensions

Type	Stroke mm	L extended	¹ Max. Compression Force N
HB-12-10	10	55	180
HB-12-20	20	75	180
HB-12-30	30	95	180
HB-12-40	40	115	180
HB-12-50	50	135	180
HB-12-60	60	155	180
HB-12-70	70	175	180
HB-12-80	80	195	150

¹ Max. extension force for all stroke lengths 180 N.

Ordering Example

HB-12-30-AC-M
 Type (Hydraulic Damper) _____
 Body Ø (12 mm) _____
 Stroke (30 mm) _____
 Piston Rod End Fitting A3,5 _____
 Body End Fitting C3,5 _____
 Damping Direction (M = out stroke only) _____

Damping Options

- P = Damping in both directions
- N = Damping on in stroke only
- M = Damping on out stroke only
- X = Special model suffix

The end fittings are interchangeable and must be positively secured by the customer to prevent unscrewing (i.e. Loctite). For mounting accessories see page 185.

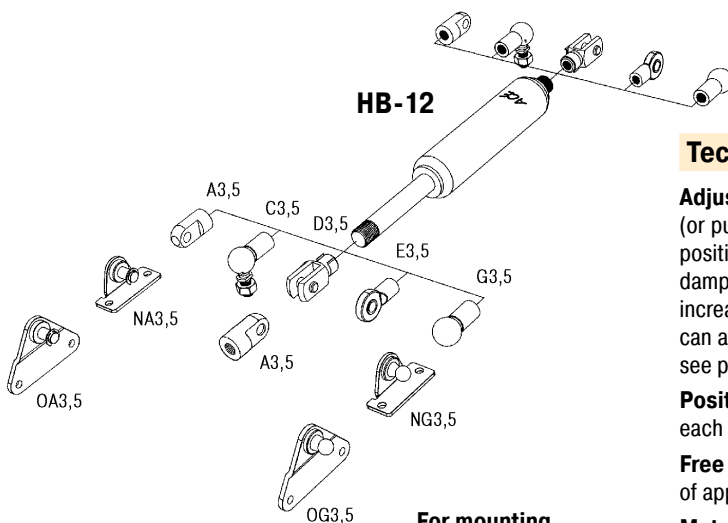

For mounting accessories see page 185.

Technical Data

Adjustment: Adjustment of the damping rate is achieved by pulling (or pushing) the piston rod to its fully extended (or compressed) position. Whilst still pulling the piston rod turn it clockwise to increase damping and anti-clockwise to decrease damping. If the resistance increases noticeably, stop adjusting to avoid damage. The adjustment can add a max. of 6 mm to the L dim. shown (adjustment instruction see page 145).

Positive stop: Provide mechanical stops 1 to 1.5 mm before end of each stroke direction.

Free travel: Construction of standard damper results in a free travel of approx. 21 % of stroke.

Material: Body: Black coated steel. Piston rod: Stainless steel (1.4305). End fittings: Zinc plated steel.

End Fitting

Standard Dimensions

End Fitting

A5 Eye **A5**
max. force 800 N

B5 Stud Thread **B5**

C5 Angle Ball Joint **C5**
max. force 500 N

D5 Clevis Fork **D5**
max. force 800 N

E5 Swivel Eye **E5**
max. force 800 N

G5 Ball Socket **G5**
max. force 500 N

Dimensions

Type	Stroke mm	L extended	1 Max. Compression Force N
HB-15-25	25	93	800
HB-15-50	50	143	800
HB-15-75	75	193	800
HB-15-100	100	243	350
HB-15-150	150	343	300

¹ Max. extension force for all stroke lengths 800 N.

Ordering Example

HB-15-150-CC-M

Type (Hydraulic Damper) _____
 Body Ø (15.6 mm) _____
 Stroke (150 mm) _____
 Piston Rod End Fitting C5 _____
 Body End Fitting C5 _____
 Damping Direction (M = out stroke only) _____

Damping Options

- P = Damping in both directions
- N = Damping on in stroke only
- M = Damping on out stroke only
- X = Special model suffix

The end fittings are interchangeable and must be positively secured by the customer to prevent unscrewing (i.e. Loctite). For mounting accessories see page 185.

Rod Shroud W5-15

Ø19
L = Stroke + 20

HB-15

A5, C5, D5, E5, G5, MA5, NA5, OA5, PA5, PG5, NG5

For mounting accessories see page 185.

Technical Data

On request: Special lengths, alternative seals and end fittings.

Mounting: In any position. End fittings must be positively secured to prevent unscrewing.

Adjustment: Adjustment of the damping rate is achieved by pulling (or pushing) the piston rod to its fully extended (or compressed) position. Whilst still pulling the piston rod turn it clockwise to increase damping and anti-clockwise to decrease damping. If the resistance increases noticeably, stop adjusting to avoid damage. The adjustment can add a max. of 6 mm to the L dim. shown (adjustment instruction see page 145).

Positive stop: Provide mechanical stops 1 to 1.5 mm before end of each stroke direction.

Free travel: Construction of standard damper results in a free travel of approx. 20 % of stroke.

Material: Body: Black coated steel. Piston rod: With wear-resistant coating. End fittings: Zinc plated steel.

Separator piston: Available as a special option to remove free travel. Also provides extension force of 40 N. Dimension: L = 2.45 x stroke + 49 mm. Part number: Add suffix -T.

End Fitting

Standard Dimensions

End Fitting

End Fitting A8
max. force 3000 N

End Fitting Eye A8
max. force 3000 N

End Fitting Stud Thread B8

End Fitting Angle Ball Joint C8
max. force 1200 N

End Fitting Clevis Fork D8
max. force 3000 N

End Fitting Swivel Eye E8
max. force 3000 N

End Fitting Ball Socket G8
max. force 1200 N

Rod Shroud W8-22
L = Stroke + 30

Dimensions			
Type	Stroke mm	L extended	1 Max. Compression Force N
HB-22-50	50	150	1 800
HB-22-100	100	250	1 800
HB-22-150	150	350	1 800
HB-22-200	200	450	1 000
HB-22-250	250	550	1 000

1 Max. extension force for all stroke lengths 1800 N.

Ordering Example
HB-22-150-DD-M
 Type (Hydraulic Damper) _____
 Body Ø (23 mm) _____
 Stroke (150 mm) _____
 Piston Rod End Fitting D8 _____
 Body End Fitting D8 _____
 Damping Direction (M = out stroke only) _____

Damping Options
 P = Damping in both directions
 N = Damping on in stroke only
 M = Damping on out stroke only
 X = Special model suffix

The end fittings are interchangeable and must be positively secured by the customer to prevent unscrewing (i.e. Loctite). For mounting accessories see page 186.

HB-22

End fittings: A8, C8, D8, E8, G8

Mounting accessories: MA8, NA8, OA8, PA8, ME8, NE8, OE8, PE8, PG8

For mounting accessories see page 186.

Technical Data

On request: Special lengths, alternative seals and end fittings.

Mounting: In any position. End fittings must be positively secured to prevent unscrewing.

Adjustment: Adjustment of the damping rate is achieved by pulling (or pushing) the piston rod to its fully extended (or compressed) position. Whilst still pulling the piston rod turn it clockwise to increase damping and anti-clockwise to decrease damping. If the resistance increases noticeably, stop adjusting to avoid damage. The adjustment can add a max. of 6 mm to the L dim. shown (adjustment instruction see page 145).

Positive stop: Provide mechanical stops 1 to 1.5 mm before end of each stroke direction.

Free travel: Construction of standard damper results in a free travel of approx. 20 % of stroke.

Material: Body: Black coated steel. Piston rod: With wear-resistant coating. End fittings: Zinc plated steel.

Separator piston: Available as a special option to remove free travel. Also provides extension force of 50 N. Dimension: L = 2.38 x stroke + 55 mm. Part number: Add suffix -T.

End Fitting

Standard Dimensions

End Fitting

A8 Eye A8 max. force 3000 N

B8 Stud Thread B8

C8 Angle Ball Joint C8 max. force 1200 N

D8 Clevis Fork D8 max. force 3000 N

E8 Swivel Eye E8 max. force 3000 N

G8 Ball Socket G8 max. force 1200 N

W8-28 Rod Shroud

Radius R7, 14, Stroke, Ø10, Ø28, 10 thick, Ø8.1, L +/- 2 mm extended + max 6 mm for adjustment setting

Dimensions			
Type	Stroke mm	L extended	1 Max. Compression Force N
HB-28-100	100	260	3 000
HB-28-150	150	360	3 000
HB-28-200	200	460	3 000
HB-28-250	250	560	3 000
HB-28-300	300	660	2 500
HB-28-350	350	760	2 000
HB-28-400	400	860	1 500
HB-28-500	500	1 060	1 000

1 Max. extension force for all stroke lengths 3000 N.

Ordering Example **HB-28-150-DD-M**

Type (Hydraulic Damper) _____
 Body Ø (28 mm) _____
 Stroke (150 mm) _____
 Piston Rod End Fitting D8 _____
 Body End Fitting D8 _____
 Damping Direction (M = out stroke only) _____

Damping Options

- P = Damping in both directions
- N = Damping on in stroke only
- M = Damping on out stroke only
- X = Special model suffix

The end fittings are interchangeable and must be positively secured by the customer to prevent unscrewing (i.e. Loctite). For mounting accessories see page 186.

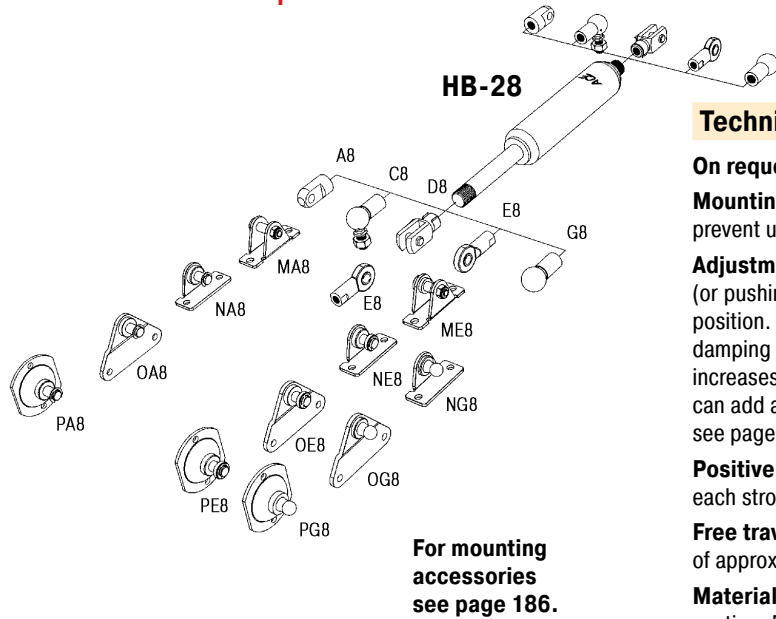

Technical Data

On request: Special lengths, alternative seals and end fittings.

Mounting: In any position. End fittings must be positively secured to prevent unscrewing.

Adjustment: Adjustment of the damping rate is achieved by pulling (or pushing) the piston rod to its fully extended (or compressed) position. Whilst still pulling the piston rod turn it clockwise to increase damping and anti-clockwise to decrease damping. If the resistance increases noticeably, stop adjusting to avoid damage. The adjustment can add a max. of 6 mm to the L dim. shown (adjustment instruction see page 145).

Positive stop: Provide mechanical stops 1 to 1.5 mm before end of each stroke direction.

Free travel: Construction of standard damper results in a free travel of approx. 20 % of stroke.

Material: Body: Black coated steel. Piston rod: With wear-resistant coating. End fittings: Zinc plated steel.

Separator piston: Available as a special option to remove free travel. Also provides extension force of 80 N. Dimension: L = 2.35 x stroke + 60 mm. Part number: Add suffix -T.

Issue 7.2014. Specifications subject to change

End Fitting

Standard Dimensions

End Fitting

A14



Eye A14
max. force 10 000 N

B14



Dimensions

Type	Stroke mm	L extended	1 Max. Compression Force N
HB-40-100	100	275	10 000
HB-40-150	150	375	10 000
HB-40-200	200	475	10 000
HB-40-300	300	675	10 000
HB-40-400	400	875	8 000
HB-40-500	500	1 075	6 000
HB-40-600	600	1 275	4 000
HB-40-700	700	1 475	3 000
HB-40-800	800	1 675	3 000

¹ Max. extension force for all stroke lengths 10 000 N.

Stud Thread B14

C14

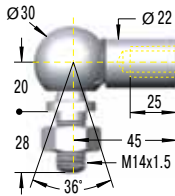

Angle Ball Joint C14
max. force 3200 N

D14

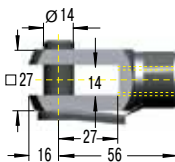

Clevis Fork D14
max. force 10 000 N

E14

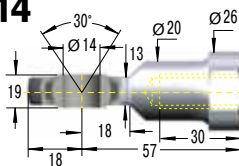

Swivel Eye E14
max. force 10 000 N

Ordering Example

Type (Hydraulic Damper) _____
 Body Ø (40 mm) _____
 Stroke (300 mm) _____
 Piston Rod End Fitting E14 _____
 Body End Fitting E14 _____
 Damping Direction (N = in stroke only) _____

HB-40-300-EE-N

Damping Options

- P = Damping in both directions
- N = Damping on in stroke only
- M = Damping on out stroke only
- X = Special model suffix

Rod Shroud W14-40

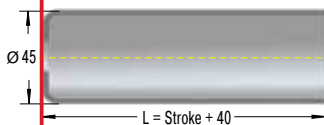

The end fittings are interchangeable and must be positively secured by the customer to prevent unscrewing (i.e. Loctite). For mounting accessories see page 187.

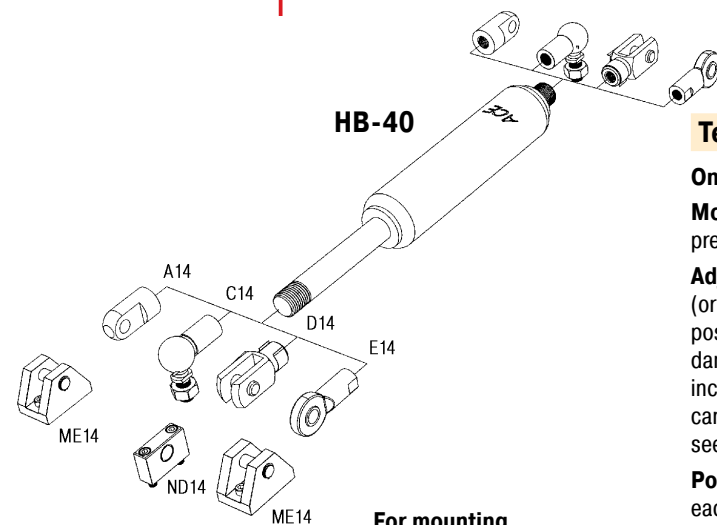

For mounting accessories see page 187.

Technical Data

On request: Special lengths, alternative seals and end fittings.

Mounting: In any position. End fittings must be positively secured to prevent unscrewing.

Adjustment: Adjustment of the damping rate is achieved by pulling (or pushing) the piston rod to its fully extended (or compressed) position. Whilst still pulling the piston rod turn it clockwise to increase damping and anti-clockwise to decrease damping. If the resistance increases noticeably, stop adjusting to avoid damage. The adjustment can add a max. of 6 mm to the L dim. shown (adjustment instruction see page 145).

Positive stop: Provide mechanical stops 1 to 1.5 mm before end of each stroke direction.

Free travel: Construction of standard damper results in a free travel of approx. 20 % of stroke.

Material: Body: Black coated steel. Piston rod: With wear-resistant coating. End fittings: Zinc plated steel.

Separator piston: Available as a special option to remove free travel. Also provides extension force of 150 N. Dimension: L = 2.32 x stroke + 82 mm. Part number: Add suffix -T.

End Fitting

Standard Dimensions

End Fitting

B24



Stud Thread **B24**

D24

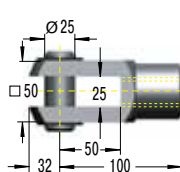

Clevis Fork D24
max. force 50 000 N

E24

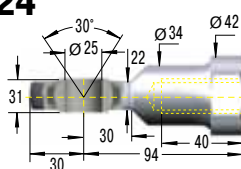

Swivel Eye E24
max. force 50 000 N

Dimensions

Type	Stroke mm	L extended	1 Max. Compression Force N
HB-70-100	100	320	50 000
HB-70-200	200	520	50 000
HB-70-300	300	720	50 000
HB-70-400	400	920	30 300
HB-70-500	500	1 120	21 600
HB-70-600	600	1 320	16 200
HB-70-700	700	1 520	12 600
HB-70-800	800	1 720	10 100

¹ Max. extension force for all stroke lengths 50 000 N.

Ordering Example

Type (Hydraulic Damper) _____
 Body Ø (70 mm) _____
 Stroke (300 mm) _____
 Piston Rod End Fitting E24 _____
 Body End Fitting E24 _____
 Damping Direction (N = in stroke only) _____

HB-70-300-EE-N

Damping Options

- P = Damping in both directions
- N = Damping on in stroke only
- M = Damping on out stroke only
- X = Special model suffix

The end fittings are interchangeable and must be positively secured by the customer to prevent unscrewing (i.e. Loctite). For mounting accessories see page 187.

Rod Shroud W24-70

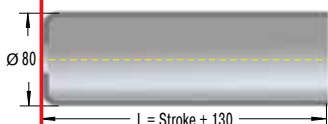

Technical Data

On request: Special lengths, alternative seals and end fittings.

Mounting: In any position. End fittings must be positively secured to prevent unscrewing.

Adjustment: Adjustment of the damping rate is achieved by pulling (or pushing) the piston rod to its fully extended (or compressed) position. Whilst still pulling the piston rod turn it clockwise to increase damping and anti-clockwise to decrease damping. If the resistance increases noticeably, stop adjusting to avoid damage. The adjustment can add a max. of 8 mm to the L dim. shown (adjustment instruction see page 145).

Positive stop: Provide mechanical stops 5 to 6 mm before end of each stroke direction.

Free travel: Construction of standard damper results in a free travel of approx. 20% of stroke.

Material: Body: Black coated steel or zinc plated steel. Piston rod: Hard chrome plated. End fittings: Zinc plated steel.

Separator piston: Available as a special option to remove free travel. Also provides extension force of min. 250 N. Increases dimension L + 150 mm. Part number: Add suffix -T.

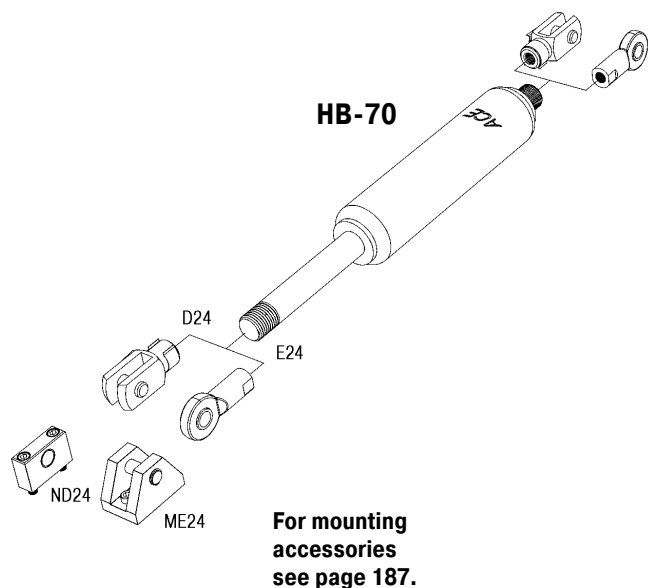

For mounting accessories see page 187.

Adjustment Instructions for HB-12 to HB-70 and HBS-28 to HBS-70



View in direction of arrow

Adjustment only possible when piston rod is **fully** extended or **fully** compressed.

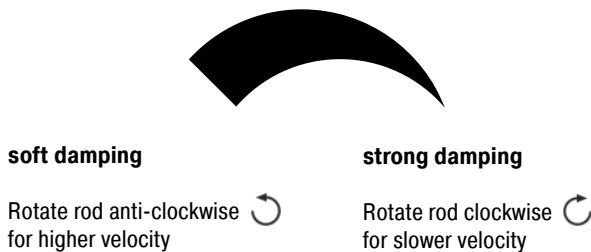

1. Hold outer body.
2. a) When piston rod is fully extended:
Adjust damping by turning the piston rod as shown in the picture. Whilst rotating, pull the piston rod gently, to ensure the adjuster locates in the end cap.
- b) When the piston rod is fully compressed:
Adjust the damping by turning the piston rod as shown in the picture. Whilst rotating, push the piston rod gently, to ensure the adjuster locates in the end cap.
3. When resistance is felt when rotating the piston rod, stop turning. You will be at the end of the adjustment.
NOTE: Do not rotate piston rod too quickly as damage could occur.
4. Check the damping, if required repeat step 1 to 3.
5. On all versions with a separator piston (type "T") adjustment is only possible when the piston rod is extended (adjustment 2a).

Standard Dimensions TD-28



Ordering Example

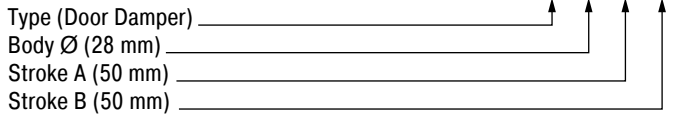

Return Type

- F = automatic return with return spring
- D = without return spring. When one piston is pushed in, the piston rod at the other end is pushed out (thus the damper must be impacted from alternate ends to sequence correctly).

Dimensions and Capacity Chart

Type	Stroke A mm	Stroke B mm	C	L max	Max. Impact Mass kg	Max. Damping Force Q N	Max. Energy Capacity		
							W ₃ Nm/Cycle	Max. Return Force N	Return Type
TD-28-50-50	50	50	220	402	150	1 550	75	30	F
TD-28-70-70	70	70	260	482	200	1 500	70	30	F
TD-28-100-100	100	100	220	502	250	1 500	80	40	F
TD-28-120-120	120	120	208	410	250	3 800	165	0	D

MB-16

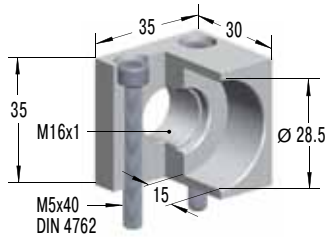

Clamp Mount
inc. screws M5x40

Standard Dimensions TDE-28

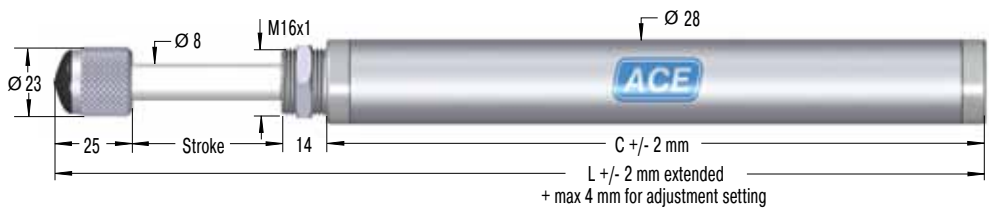

Ordering Example

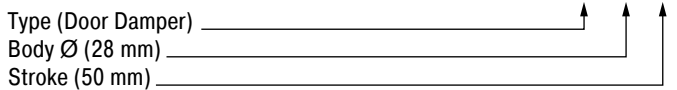

Technical Data

On request: With different deceleration characteristics, special stroke lengths, special seals etc.

Impact velocity range: 0.1 to 2 m/s

Adjustment: Pull the piston rod fully out and turn the knurled rod end button. The internal toothed adjustment allows the damping to be separately adjusted for each side. As a result of the adjustment mechanism the overall length L can be increased by up to 4 mm.

Material: Piston rod: Hard chrome plated steel. Cylinder body: Zinc plated steel.

Operating temperature range: -20 °C to 80 °C

Function: ACE door dampers are single ended or double ended adjustable hydraulic shock absorbers used for the cushioning of elevator doors, automatic and sliding doors and similar applications.

Strokes per minute: Max. 10

Dimensions and Capacity Chart

Type	Stroke mm	C	L max	Max. Impact Mass kg	Max. Damping Force Q N	Max. Energy Capacity	
						W ₃ Nm/Cycle	Max. Return Force N
TDE-28-50	50	130	221	4 000	2 400	80	30
TDE-28-70	70	158	269	5 600	2 400	112	30
TDE-28-100	100	193	333	8 000	2 400	160	30
TDE-28-120	120	214	373	7 000	2 400	190	40



Swinging movements cushioned by hydraulic dampers

Passengers always feel the swinging movement involved when cable cars arrive at the ski station.

Maintenance-free **hydraulic dampers** type **HB-40-300-EE-X-P** cushion these movements perfectly. Designers of the cable cars, connected by means of an articulated joint via a four-point frame and connection guide to the suspension rod, profit from the ability of the adjustable dampers to absorb compressive forces of up to 10 000 N on either side.



Hydraulic dampers for added convenience when operating cable cars

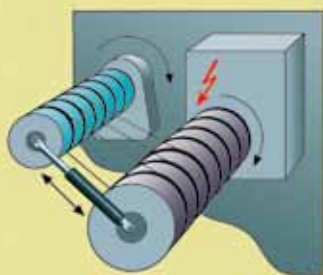

Precise unreeling

Hydraulic dampers bring the sled movement of this textile machine to a gentle stop.

At the turning point of 130 kg reeling spools, a sled should move up and down smoothly without causing a collision at the end of stroke position. The solution was provided by the hydraulic damper **DVC-32-100**. A self-contained sealed unit, ready to install and maintenance-free these units are ideal for precise control of speeds in both directions of travel. The travel speed is maintained throughout the entire stroke and can be independently adjusted in each direction of travel. Thanks to their compact design and wide choice of mounting accessories, these dampers could be easily integrated into this machine.



Textile machine unreels threads even better

Gas springs are universally accepted, wherever you want to

- push
- pull
- lift
- lower, or
- position

covers, lids or other components by hand without using an external energy source. ACE gas springs are individually filled to a predetermined pressure to suit a customer's requirement (extension Force F_1). The cross-sectional area of the piston rod and filling pressure determines the extension force $F = p \cdot A$. During the compression of the piston rod, nitrogen flows through an orifice in the piston from the full bore side of the piston to the annulus. The nitrogen is compressed by the volume of the piston rod. As the piston rod is compressed the pressure increases, so increasing the reaction force (progression). The force depends on the proportional relationship between the piston rod and the inner tube diameter, which is approximately linear.

Force-Stroke Characteristics of Gas Spring (Push Type)

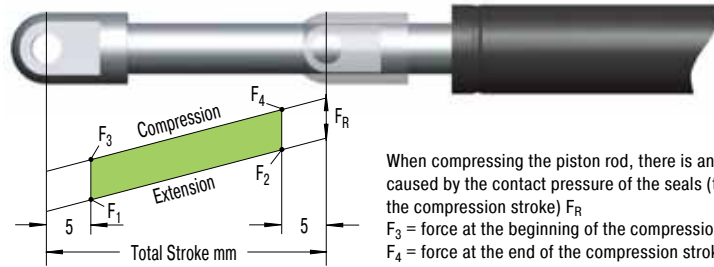

When compressing the piston rod, there is an additional friction force caused by the contact pressure of the seals (this only occurs during the compression stroke) F_R
 F_3 = force at the beginning of the compression stroke
 F_4 = force at the end of the compression stroke

F_1 = nominal force at 20 °C (this is the pressure figure normally used when specifying the gas spring)

F_2 = force in the complete compressed position

Force-Stroke Characteristics of Traction Gas Spring (Pull Type)

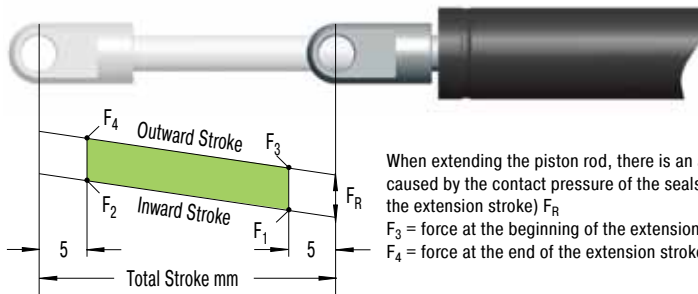

When extending the piston rod, there is an additional friction force caused by the contact pressure of the seals (this only occurs during the extension stroke) F_R
 F_3 = force at the beginning of the extension stroke
 F_4 = force at the end of the extension stroke

F_1 = nominal force at 20 °C (this is the pressure figure normally used when specifying the gas spring)

F_2 = force in the complete extended position

Gas Springs (Push Type)

Type	¹ Progression approx. %	² Friction F_R approx. in N
GS-8	28	10
GS-10	20	10
GS-12	25	20
GS-15	27	20
GS-19	26 - 39 ³	30
GS-22	30 - 40 ³	30
GS-28	58 - 67 ³	40
GS-40	37 - 49 ³	50
GS-70	25	50

Gas Springs (Pull Type)

Type	¹ Progression approx. %	² Friction F_R approx. in N
GZ-15	23	55 - 140
GZ-19	10	20 - 40
GZ-28	20	100 - 200
GZ-40	40	

¹ The progression (the slope of the force line in the diagrams above) is due to the reduction of the internal gas volume as the piston rod moves from its initial position to its fully stroked position. The approx. progression values given above for standard springs can be altered on request.
Effect of temperature: The nominal F_1 figure is given at 20 °C. An increase of 10 °C will increase force by 3.4%.
Filling tolerance on F_1 force: -20 N to +40 N or 5% to 7%. Depending on size and extension force the tolerances can differ.

² Depending on the filling force.

³ Depending on the stroke.

Service Life

Filling tolerance: -20 N to +40 N or 5% to 7%. Depending on size and extension force the tolerances can differ.

Effect of temperature: An increase in temperature of each 10 °C will increase force by approx. 3.4 %.

Temperature range: -20 °C to +80 °C (special seals from -45 °C to 200 °C)

Mounting: The gas springs should ideally be installed with the **piston rod pointing downwards** to use the end damping during the extension stroke to smoothly decelerate the motion of the gas spring. Some ACE gas springs have a uniquely designed front bearing with an integrated grease chamber allowing the gas spring to be mounted and operated in any position if required.

When fitting the gas springs ensure that the stroke is fully extended (GZ type fully compressed), this makes assembly and disassembly much easier. **Support the moving mass/flap during assembly or disassembly to prevent accidents. To avoid twisting or side loading, it is recommended that ball joints or other pivoted mounting attachments are used.** The mounting attachments must always be securely tightened onto the threaded studs of the gas spring.

ACE gas springs are maintenance-free. DO NOT oil or grease the piston rod!

The piston rod must be protected from any hits, scratches or dirt and especially paint. Damage to the surface finish of the piston rod will destroy the sealing system and cause loss of pressure. The outer body must not be deformed or mechanically damaged.

ACE gas springs can be stored in any position. Experience has shown that long storage periods do not result in loss of pressure. However you may experience some "stiction" requiring a higher effort to move the gas spring for the first time after a long storage period.

Generally, ACE gas springs are tested to 70 000 to 100 000 complete strokes. This is equivalent to the seal lifetime (depending on model size) to a distance travelled of 10 km (for lifetime of traction gas springs see pages 175 to 183). During these tests the gas spring must not lose more than 5% of its pressure. Depending upon the application and operating environment, the service life of these gas springs may be much longer. In practise 500 000 strokes or more have been achieved on some applications.

Adjustment Instructions Valve with ACE DE-GAS

GS



GZ



Adjustment Instruction

1. Hold gas spring valve up.
2. Insert DE-GAS adjuster knob on thread of the valve.
3. Press the DE-GAS adjuster knob with light hand force until you can hear the nitrogen escaping. Press only briefly to avoid too much nitrogen being discharged.
4. After adjustment, remove the DE-GAS adjuster knob, mount the end fittings and test the gas spring in your application. If necessary repeat the procedure.

If you use 2 gas springs in parallel, both gas springs should have the same force to avoid bending forces or side load on the application. If necessary return to ACE to refill both gas springs to the same (average) force.

If too much nitrogen is discharged, the units can be returned to ACE for re-gassing.

"Easy, safe, reliable!"

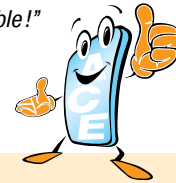

Gas Spring Refilling Kit



The **ACE gas spring refilling kit** offers you the opportunity to fill gas springs on location or adapt them individually. The refilling kit is equipped with all the parts you need to fill gas springs. Very precise filling of the gas springs is possible using the digital manometer. The table for determining the filling pressure of the gas springs is included with the case. The only thing missing from the delivery is the nitrogen.

The refilling kit contains all filling bells and adjuster knobs for the current ACE gas spring range.

Part number for the complete gas spring refilling kit: GS-FK-C

The refilling kit suits 200 bar nitrogen bottles with a thread of W24,32x1/14" (German standard). Other connections are available upon request.

Gas springs filled with the refilling kit must be measured **on a calibrated measurement system by ACE** for repeat production.

Calculation

To obtain the ideal selection to give the optimum operation for a gas spring it is important to identify the following points:

- gas spring size
- required gas spring stroke
- mounting points on flap and frame
- extended length of the gas spring
- required extension force
- hand forces throughout the complete movement on the flap

With our **free calculation service** you can eliminate the time-consuming calculation and send us your details by fax or e-mail. Just complete the information shown on the calculation formulae page number 151. Please attach a sketch of your application (a simple hand sketch is sufficient) in side view. Our application engineers will determine the optimum gas springs and mounting points and calculate the ideal situation to satisfy your requirements.

You will receive a quotation showing the opening and closing forces and our recommended mounting points to suit your application.

Input data		Identification data	
Start angle	α : 270 °	Temperature	: 20 °C
Open angle	α : 105 °	Progression	: 42 %
Rd. ctr.gnty.	RH: 410 mm	Friction	: 30 %
Mass	m: 12 kg	Ext. length	: 504 mm
No. gas springs	n: 2		
Radius handforce	RH: 820 mm		

Required user hand-forces			
F1-F2/F3-F4=Hand forces for opening/closing			
Angle [°]	F1-F2 [N]	F3-F4 [N]	Length [mm]
270	-13	-14	311
293	37	42	323
317	59	68	363
340	53	63	418
363	34	44	477
375	25	34	504

F1-F4 positive requires clockwise hand force
F1-F4 negative requires counter-clockwise hand force

Gas spring 90°/y
DP (Pivot)
Mounting Points
(xPm=-20, yPm=-455) (xLm=-16, yLm=-144)
Distances of mounting points are based on pivot (DP)
xP= horizontal / yP= vertical position of fixed point
xL= horizontal / yL= vertical position of moving point

"Calculation offer with all required details for assembly!"

Safety Instructions

Gas springs are filled with pure nitrogen gas. Nitrogen is an inert gas that does not burn or explode and is not poisonous.

Please note!: the internal pressure of gas springs can be up to 300 bar. Do not attempt to open or modify them.

ACE gas springs will operate in surrounding temperatures from -20 °C to +80 °C. We can equip our springs with special seals to withstand temperatures as low as -45 °C or as high as +200 °C. Gas springs should not be placed over heat or in open fire!

Disposal/Recycling: Gas Springs consist mostly of metal and the metal could be recycled, but first the gas pressure must be removed. Please ask for our disposal recommendations which advise how to depressurize the gas springs and make them safe to recycle.

All gas springs are marked with the part number, the production date and a warning sign "Do not open high pressure". We are not responsible for any damages of any kind that arises due to goods that are not marked accordingly.

Gas springs should be installed with the piston rod downwards. This position ensures best damping quality. **Only ACE gas springs include an integrated grease chamber which allows for alternative mounting opportunities.**

Gas springs should not be exposed to tilting or side load forces during operation or whilst static (this can cause bending of the piston rod or early wear).

Gas springs are maintenance-free. **Do not grease or oil the piston rod.**

The piston rod must not be painted and should be protected against shocks, scratches and dirt. The cylinder should not be deformed as such damage would destroy the sealing system.

ACE gas springs can be stored in any position. Pressure lost through long storage is not to be expected. There are no known negative values, but there may be a sticking effect the first time you compress a spring. This may require a higher initial force to operate the gas spring for the first time (initial breakaway force).

Gas springs of all sizes are classified as pressure vessels according to the pressure device directive 97/23/EC. They have a pressure level of more than 0.5 bar. All ACE gas springs are developed, manufactured and tested according to this directive.

The tolerance for the installation length is generally deemed to be ± 2 mm. If very high demands are placed on durability and stability, please avoid the combination of small diameter + long stroke + high force.

The filling tolerance is -20 N to 40 N or 5% to 7%. Depending on size and extension force the tolerances can differ.

Push type Pull type

Input date

Gas spring fixing points

The fixed point of the frame and the moving point of the flap are critical for the optimum operation.

Therefore please attach a sketch of your application (a few lines with their dimensions are sufficient)!

Moving mass* m _____ kg
 Number of gas springs in parallel* n _____ pcs
 Number of movements* _____ /day
 Ambient temperature T _____ °C

If not shown by the sketch:

Radius of centre of gravity R_M _____ mm
 Radius of hand force R_H _____ mm
 Starting angle α_M _____ °
 Opening angle α _____ °

* Compulsory information

Desired Mounting Fittings

End Fitting		End Fitting
<input type="checkbox"/> A		<input type="checkbox"/> A
<input type="checkbox"/> B		<input type="checkbox"/> B
<input type="checkbox"/> C		<input type="checkbox"/> C
<input type="checkbox"/> D		<input type="checkbox"/> D
<input type="checkbox"/> E		<input type="checkbox"/> E
<input type="checkbox"/> F		<input type="checkbox"/> F
<input type="checkbox"/> G		<input type="checkbox"/> G

The end fittings are interchangeable.

e.g. -CE: C = Angle Ball Joint, E = Swivel Eye

Hood

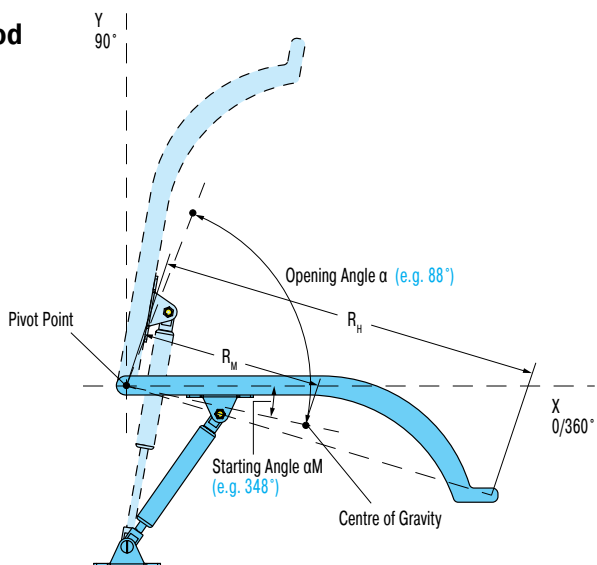

Flap

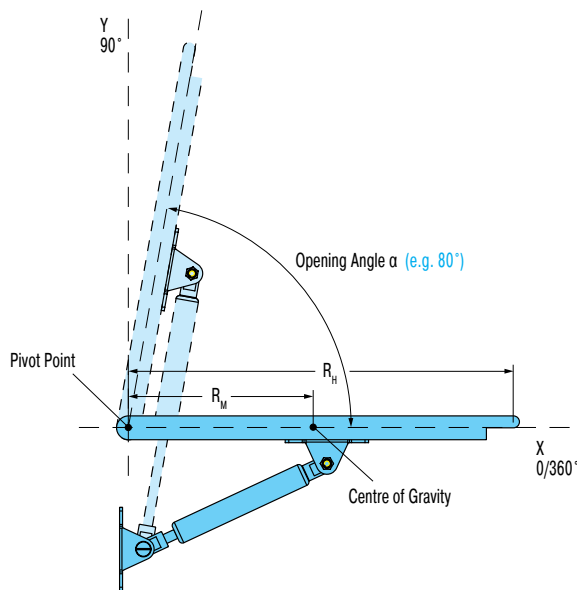

Please send us a sketch with dimensions of your application! Without this sketch we won't be able to calculate.

Comments _____

Requirement per year _____

Machine type / reference _____

Sender

Company _____

Dept. _____

Address _____

Name _____

Telephone _____ Fax _____

Internet _____

E-Mail _____

Please copy, complete and fax to ACE: Fax (248) 476-2470

ACE industrial gas springs are maintenance-free and self-contained. They are available with body diameters from 8 mm up to 70 mm, and forces from 10 N up to 13 000 N ex. stock. **ACE gas springs offer a high service life with a wear-resistant coating on the piston rod. Also an integrated low friction bearing with grease chamber which provides a very low break away force (GS-19 to GS-40).** It allows them to be mounted in any orientation, although rod downwards is preferable if you want to take advantage of the built-in end position damping. The valve allows the force to be adjusted to your specific requirements. A wide variety of interchangeable end fittings makes installation easy and versatile. ACE gas springs are universally applicable wherever you have lifting and lowering. They remove the need for "muscle power" and provide controlled motion for lids, hoods, machine guards etc. The **free ACE selection software** quickly specifies the correct gas spring for your individual application and we can deliver, usually within 24 hours.



"Force adjustable to your specific requirements – with gas valve ex. stock!"

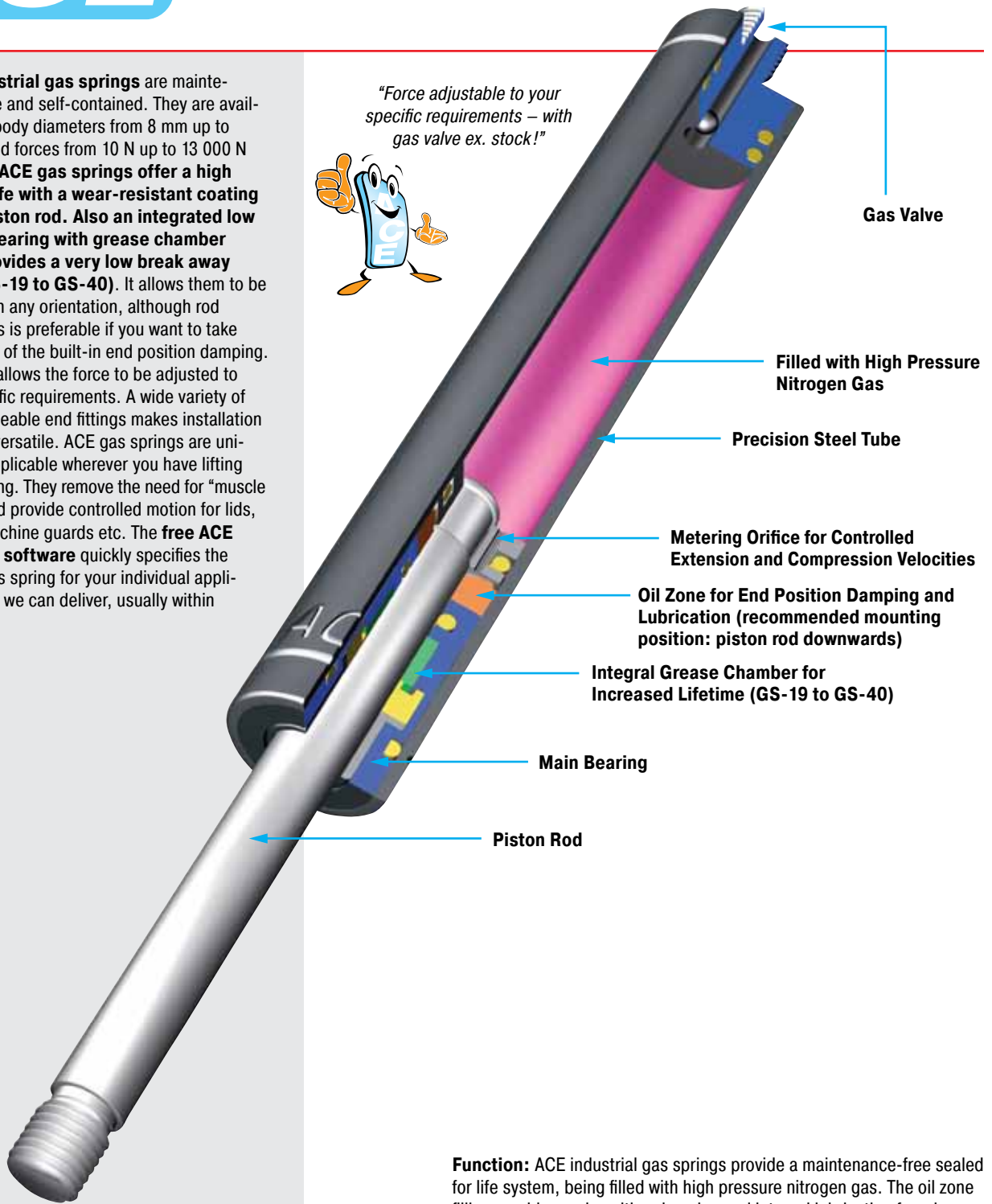

Function: ACE industrial gas springs provide a maintenance-free sealed for life system, being filled with high pressure nitrogen gas. The oil zone filling provides end position damping and internal lubrication for a long lifetime. On the extension stroke of the gas spring, for example when opening a car tailgate, the nitrogen gas flows through the metering orifice in the piston to provide a controlled opening speed and the oil zone provides damping at the fully open position to avoid impact damage. The gas spring should be mounted "rod down" for this damping to be effective. On closing the tailgate the gas spring helps support the weight. The metering orifice controls the extension and compression velocities of the gas spring.

Operating fluid: Nitrogen gas and oil

Operating temperature range: -20 °C to 80 °C

On request: Without damping, different end position damping, special force curves, special lengths, alternative end fittings.



Extension Forces 10 N to 100 N
(when Piston Rod Compressed up to 130 N)

End Fitting

Standard Dimensions

End Fitting

A3,5

B3,5

C3,5

D3,5

E3,5

G3,5

Rod Shroud W3,5-8

Eye A3,5
max. force 370 N

Stud Thread B3,5

Angle Ball Joint C3,5
max. force 370 N

Clevis Fork D3,5
max. force 370 N

Swivel Eye E3,5
max. force 370 N

Ball Socket G3,5
max. force 370 N

Adjuster Knob DE-GAS-3,5
See page 149.

Dimensions		
Type	Stroke mm	L extended
GS-8-20	20	72
GS-8-30	30	92
GS-8-40	40	112
GS-8-50	50	132
GS-8-60	60	152
GS-8-80	80	192

Ordering Example

GS-8-30-AC-30

Type (Push Type) _____

Body Ø (8 mm) _____

Stroke (30 mm) _____

Piston Rod End Fitting A3,5 _____

Body End Fitting C3,5 _____

Nominal Force F₁ 30 N _____

The end fittings are interchangeable.
For mounting accessories see page 185.

Issue 7.2014. Specifications subject to change

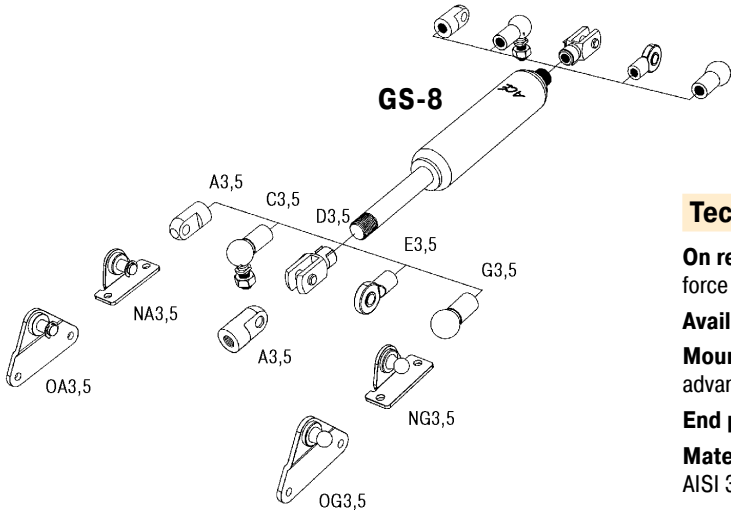

For mounting accessories see page 185.

Technical Data

- On request:** Without damping, strong end position damping, special force curves, special lengths, alternative end fittings.
- Available force range F₁ at 20 °C:** 10 N to 100 N
- Mounting:** We recommend mounting with piston rod downwards to take advantage of the built-in end position damping.
- End position damping length:** Approx. 5 mm
- Material:** Body: Black coated steel. Piston rod: Stainless steel (1.4305, AISI 303). End fittings: Zinc plated steel.
- Progression:** Approx. 28 %, F₂ max. 130 N

Extension Forces 10 N to 100 N
(when Piston Rod Compressed up to 120 N)

End Fitting

Standard Dimensions

End Fitting

A3,5



Eye A3,5
max. force 370 N

B3,5

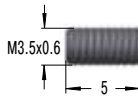

Dimensions

Type	Stroke mm	L extended
GS-10-20	20	72
GS-10-30	30	92
GS-10-40	40	112
GS-10-50	50	132
GS-10-60	60	152
GS-10-80	80	192

Stud Thread B3,5

C3,5

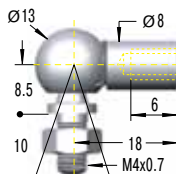

Angle Ball Joint C3,5
max. force 370 N

D3,5

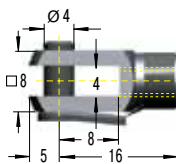

Clevis Fork D3,5
max. force 370 N

E3,5

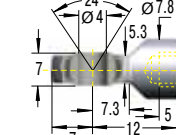

Swivel Eye E3,5
max. force 370 N

G3,5

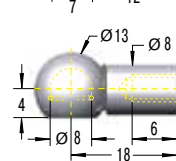

Ball Socket G3,5
max. force 370 N

Ordering Example

GS-10-80-AC-60

Type (Push Type) _____
 Body Ø (10 mm) _____
 Stroke (80 mm) _____
 Piston Rod End Fitting A3,5 _____
 Body End Fitting C3,5 _____
 Nominal Force F₁ 60 N _____

The end fittings are interchangeable.
For mounting accessories see page 185.

Rod Shroud W3,5-10

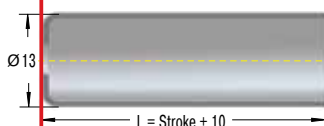

Adjuster Knob DE-GAS-3,5
See page 149.

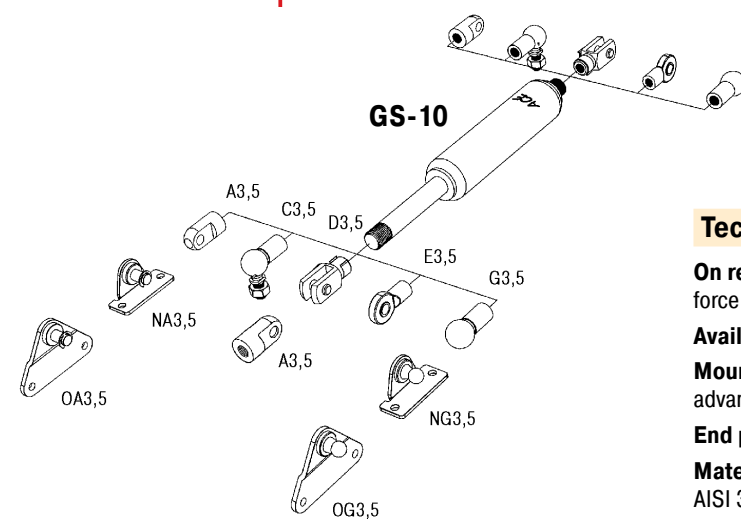

For mounting accessories see page 185.

Technical Data

On request: Without damping, strong end position damping, special force curves, special lengths, alternative end fittings.

Available force range F₁ at 20 °C: 10 N to 100 N

Mounting: We recommend mounting with piston rod downwards to take advantage of the built-in end position damping.

End position damping length: Approx. 5 mm

Material: Body: Black coated steel. Piston rod: Stainless steel (1.4305, AISI 303). End fittings: Zinc plated steel.

Progression: Approx. 20 %, F₂ max. 120 N

Extension Forces 10 N to 180 N
(when Piston Rod Compressed up to 225 N)

End Fitting

Standard Dimensions

End Fitting

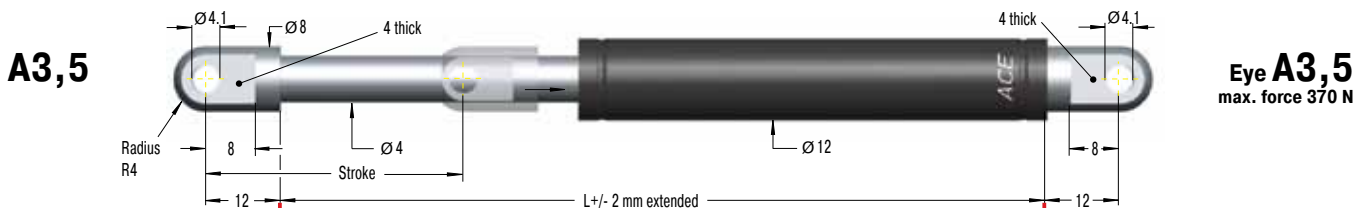

A3,5

Eye A3,5
max. force 370 N

B3,5

Stud Thread B3,5

C3,5

Angle Ball Joint C3,5
max. force 370 N

D3,5

Clevis Fork D3,5
max. force 370 N

E3,5

Swivel Eye E3,5
max. force 370 N

G3,5

Ball Socket G3,5
max. force 370 N

Rod Shroud W3,5-12

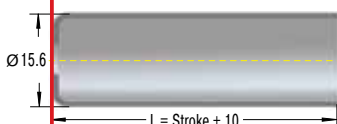

Dimensions

Type	Stroke mm	L extended	F ₁ max. N
GS-12-20	20	72	180
GS-12-30	30	92	180
GS-12-40	40	112	180
GS-12-50	50	132	180
GS-12-60	60	152	180
GS-12-80	80	192	150
GS-12-100	100	232	150
GS-12-120	120	272	120
GS-12-150	150	332	100

Ordering Example

GS-12-100-AA-30

Type (Push Type) _____
 Body Ø (12 mm) _____
 Stroke (100 mm) _____
 Piston Rod End Fitting A3,5 _____
 Body End Fitting A3,5 _____
 Nominal Force F₁ 30 N _____

The end fittings are interchangeable.
For mounting accessories see page 185.

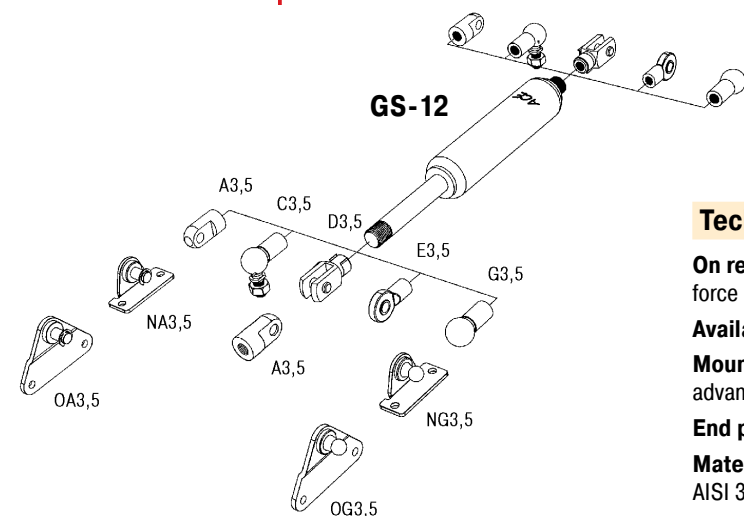

For mounting accessories see page 185.

Technical Data

On request: Without damping, strong end position damping, special force curves, special lengths, alternative end fittings.

Available force range F₁ at 20 °C: 10 N to 180 N

Mounting: We recommend mounting with piston rod downwards to take advantage of the built-in end position damping.

End position damping length: Approx. 10 mm

Material: Body: Black coated steel. Piston rod: Stainless steel (1.4305, AISI 303). End fittings: Zinc plated steel.

Progression: Approx. 25 %, F₂ max. 225 N

Adjuster Knob DE-GAS-3,5
See page 149.

End Fitting

Standard Dimensions

End Fitting

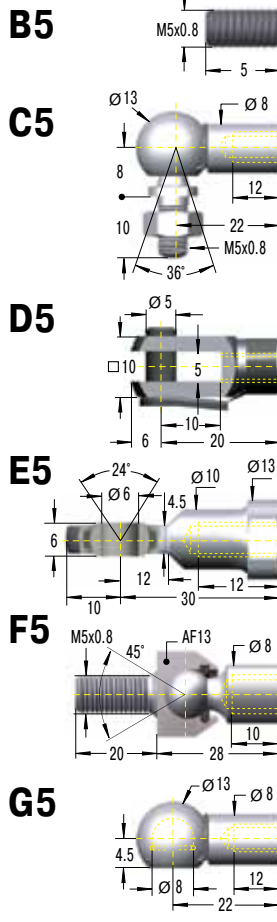
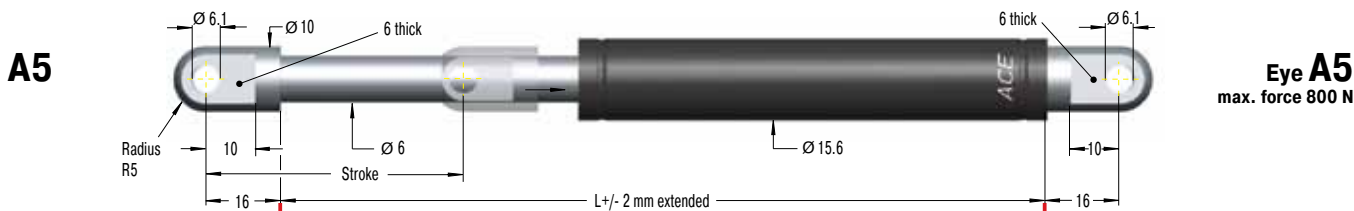

Dimensions		
Type	Stroke mm	L extended
GS-15-20	20	67
GS-15-40	40	107
GS-15-50	50	127
GS-15-60	60	147
GS-15-80	80	187
GS-15-100	100	227
GS-15-120	120	267
GS-15-150	150	327
GS-15-200	200	427

Ordering Example **GS-15-150-AC-150**

Type (Push Type) _____
 Body Ø (15.6 mm) _____
 Stroke (150 mm) _____
 Piston Rod End Fitting A5 _____
 Body End Fitting C5 _____
 Nominal Force F_1 150 N _____

The end fittings are interchangeable.
For mounting accessories see page 185.

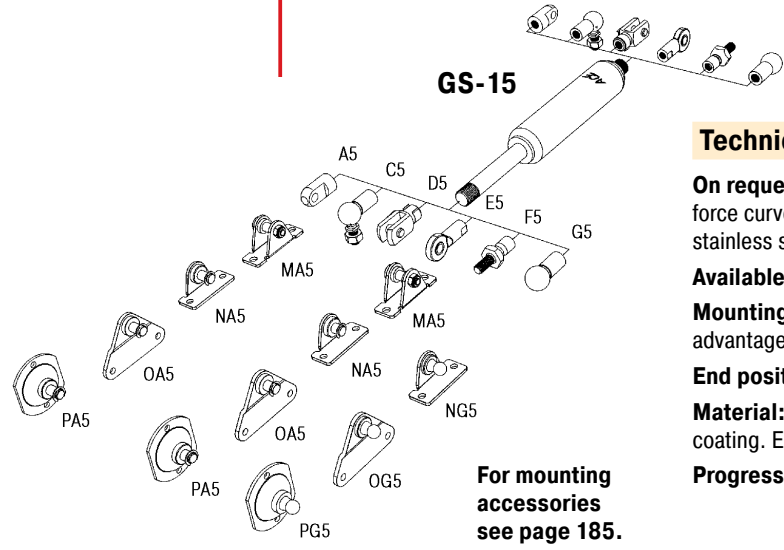
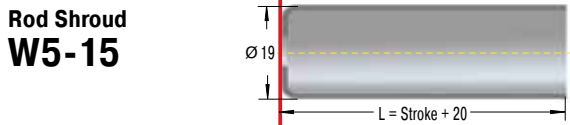

For mounting accessories see page 185.

Technical Data

On request: Without damping, strong end position damping, special force curves, special lengths, strokes, alternative end fittings, wiper, stainless steel (see pages 165 to 172).

Available force range F_1 at 20 °C: 40 N to 400 N

Mounting: We recommend mounting with piston rod downwards to take advantage of the built-in end position damping.

End position damping length: Approx. 10 mm

Material: Body: Black coated steel. Piston rod: With wear-resistant coating. End fittings: Zinc plated steel.

Progression: Approx. 27 %, F_2 max. 500 N

Adjuster Knob DE-GAS-5
See page 149.

Issue 7.2014. Specifications subject to change

End Fitting

Standard Dimensions

End Fitting

A8

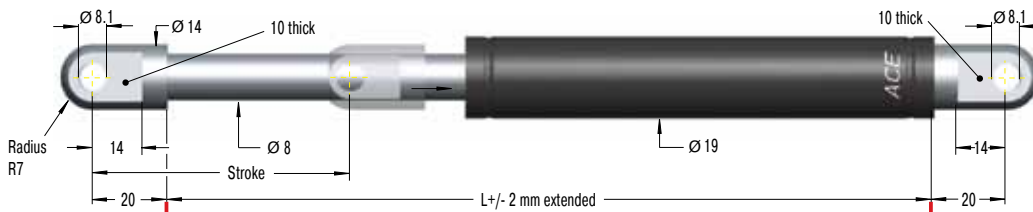

Eye A8
max. force 3000 N

B8

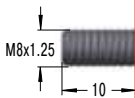

Stud Thread B8

C8

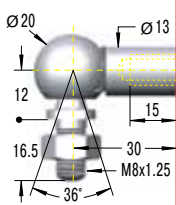

Angle Ball Joint C8
max. force 1200 N

D8

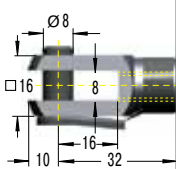

Clevis Fork D8
max. force 3000 N

E8

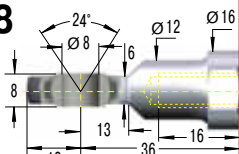

Swivel Eye E8
max. force 3000 N

F8

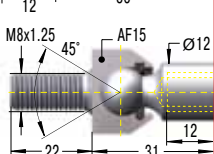

Inline Ball Joint F8
max. force 1200 N

G8

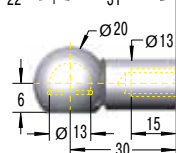

Ball Socket G8
max. force 1200 N

Rod Shroud W8-19

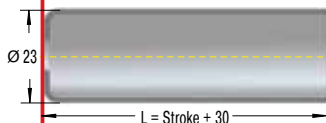

Dimensions		
Type	Stroke mm	L extended
GS-19-50	50	164
GS-19-100	100	264
GS-19-150	150	364
GS-19-200	200	464
GS-19-250	250	564
GS-19-300	300	664

Ordering Example

GS-19-150-AC-600

Type (Push Type) _____
 Body Ø (19 mm) _____
 Stroke (150 mm) _____
 Piston Rod End Fitting A8 _____
 Body End Fitting C8 _____
 Nominal Force F₁ 600 N _____

The end fittings are interchangeable.
For mounting accessories see page 186.

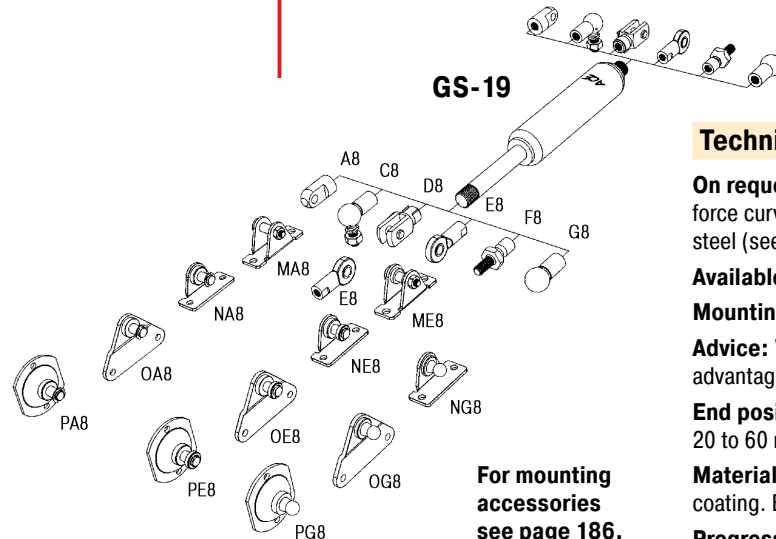

For mounting accessories see page 186.

Technical Data

On request: Without damping, standard end position damping, special force curves, special lengths, alternative end fittings, wiper, stainless steel (see pages 165 to 172).

Available force range F₁ at 20 °C: 50 N to 700 N

Mounting: In any position

Advice: We recommend mounting with piston rod downwards to take advantage of the built-in end position damping.

End position damping length: Strong end position damping approx. 20 to 60 mm (depending on the stroke) and slow extension speed.

Material: Body: Black coated steel. Piston rod: With wear-resistant coating. End fittings: Zinc plated steel.

Progression: Approx. 26 % to 39 %, F₂ max. 970 N

End Fitting

Standard Dimensions

End Fitting

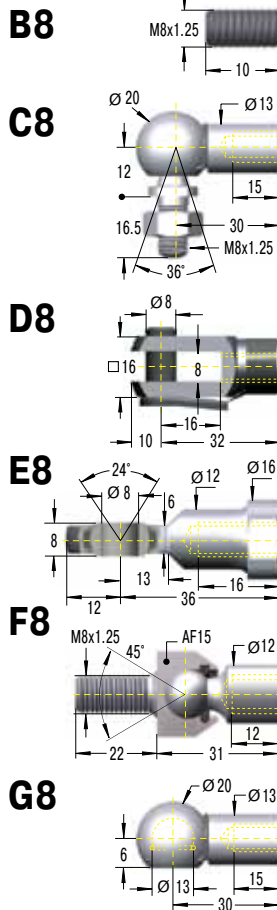
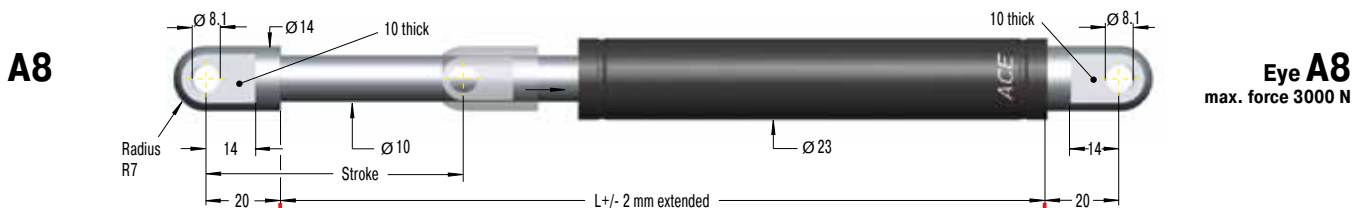

Dimensions		
Type	Stroke mm	L extended
GS-22-50	50	164
GS-22-100	100	264
GS-22-150	150	364
GS-22-200	200	464
GS-22-250	250	564
GS-22-300	300	664
GS-22-350	350	764
GS-22-400	400	864
GS-22-450	450	964
GS-22-500	500	1 064
GS-22-550	550	1 164
GS-22-600	600	1 264
GS-22-650	650	1 364
GS-22-700	700	1 464

Ordering Example
GS-22-150-AE-800
 Type (Push Type) _____
 Body Ø (23 mm) _____
 Stroke (150 mm) _____
 Piston Rod End Fitting A8 _____
 Body End Fitting E8 _____
 Nominal Force F₁ 800 N _____

The end fittings are interchangeable.
For mounting accessories see page 186.

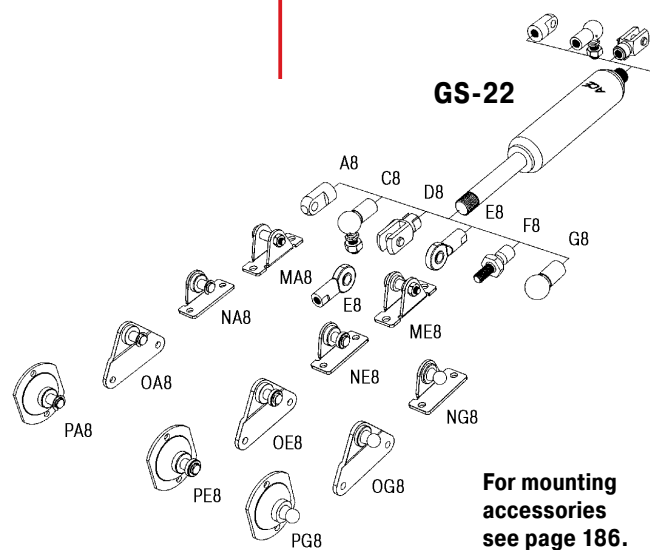
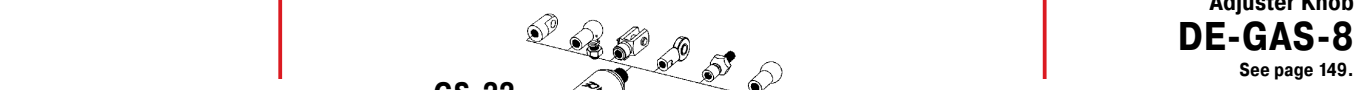
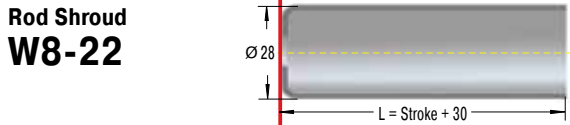

For mounting accessories see page 186.

Technical Data

On request: Without damping, standard end position damping, special force curves, special lengths, alternative end fittings, wiper, stainless steel (see pages 165 to 172).
Available force range F₁ at 20 °C: 80 N to 1300 N
Mounting: In any position
Advice: We recommend mounting with piston rod downwards to take advantage of the built-in end position damping.
End position damping length: Strong end position damping approx. 20 to 70 mm (depending on the stroke) and slow extension speed.
Material: Body: Black coated steel. Piston rod: With wear-resistant coating. End fittings: Zinc plated steel.
Progression: Approx. 30 % to 40 %, F₂ max. 1820 N

Issue 7.2014. Specifications subject to change

Extension Forces 150 N to 2500 N
(when Piston Rod Compressed up to 4175 N)

End Fitting

Standard Dimensions

End Fitting



B10

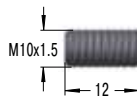

Stud Thread B10

C10

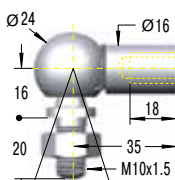

Angle Ball Joint C10

max. force 1800 N

D10

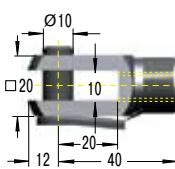

Clevis Fork D10

max. force 10 000 N

E10

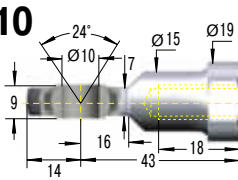

Swivel Eye E10

max. force 10 000 N

F10

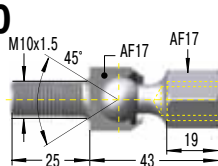

Inline Ball Joint F10

max. force 1800 N

Dimensions

Type	Stroke mm	L extended
GS-28-100	100	262
GS-28-150	150	362
GS-28-200	200	462
GS-28-250	250	562
GS-28-300	300	662
GS-28-350	350	762
GS-28-400	400	862
GS-28-450	450	962
GS-28-500	500	1 062
GS-28-550	550	1 162
GS-28-600	600	1 262
GS-28-650	650	1 362
GS-28-700	700	1 462
GS-28-750	750	1 562

Ordering Example

GS-28-150-EE-1200

Type (Push Type) _____
 Body Ø (28 mm) _____
 Stroke (150 mm) _____
 Piston Rod End Fitting E10 _____
 Body End Fitting E10 _____
 Nominal Force F₁ 1200 N _____

The end fittings are interchangeable.
For mounting accessories see page 186.

Rod Shroud W10-28

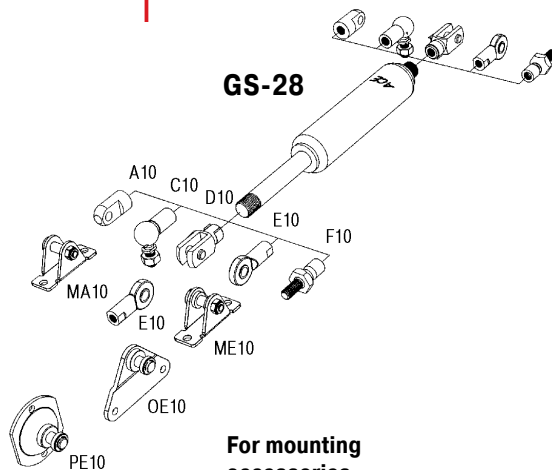
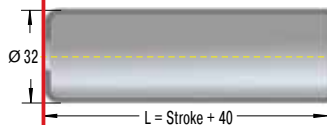

For mounting accessories see page 186.

Technical Data

On request: Without damping, standard end position damping, special force curves, special lengths, alternative end fittings, wiper, stainless steel (see pages 165 to 172).

Available force range F₁ at 20 °C: 150 N to 2500 N

Mounting: In any position

Advice: We recommend mounting with piston rod downwards to take advantage of the built-in end position damping.

End position damping length: Strong end position damping approx. 30 to 70 mm (depending on the stroke) and slow extension speed.

Material: Body: Black coated steel. Piston rod: With wear-resistant coating. End fittings: Zinc plated steel.

Progression: Approx. 58 % to 67 %, F₂ max. 4175 N

Extension Forces 500 N to 5000 N
(when Piston Rod Compressed up to 7450 N)

End Fitting

Standard Dimensions

End Fitting

A14

Radius R12.5

Ø14.1

Ø25

14 thick

21

Stroke

Ø20

40

Ø40

L +/- 2 mm extended

Eye A14
max. force 10 000 N

Stud Thread B14

Angle Ball Joint C14
max. force 3200 N

Clevis Fork D14
max. force 10 000 N

Swivel Eye E14
max. force 10 000 N

Inline Ball Joint F14
max. force 3200 N

Adjuster Knob DE-GAS-14
See page 149.

Dimensions		
Type	Stroke mm	L extended
GS-40-100	100	317
GS-40-150	150	417
GS-40-200	200	517
GS-40-300	300	717
GS-40-400	400	917
GS-40-500	500	1 117
GS-40-600	600	1 317
GS-40-800	800	1 717
GS-40-1000	1 000	2 117

Ordering Example **GS-40-150-DD-3500**

Type (Push Type) _____

Body Ø (40 mm) _____

Stroke (150 mm) _____

Piston Rod End Fitting D14 _____

Body End Fitting D14 _____

Nominal Force F₁ 3500 N _____

The end fittings are interchangeable.
For mounting accessories see page 187.

Rod Shroud W14-40

Ø45

L = Stroke + 40

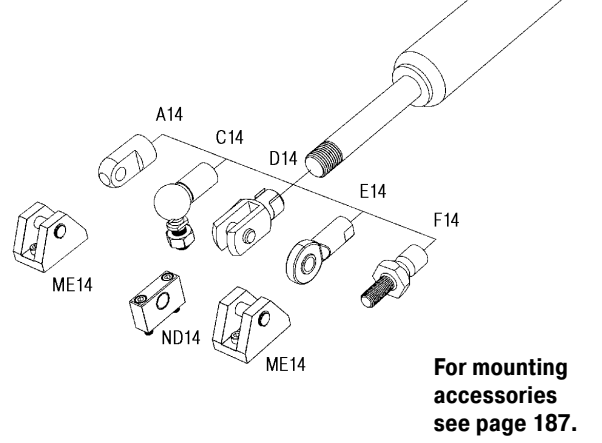

Technical Data

On request: Without damping, standard end position damping, special force curves, special lengths, alternative end fittings, wiper, stainless steel (see pages 165 to 172).

Available force range F₁ at 20 °C: 500 N to 5000 N

Mounting: In any position

Advice: We recommend mounting with piston rod downwards to take advantage of the built-in end position damping.

End position damping length: Strong end position damping approx. 30 to 70 mm (depending on the stroke) and slow extension speed.

Material: Body: Black coated steel. Piston rod: With wear-resistant coating. End fittings: Zinc plated steel.

Progression: Approx. 37 % to 49 %, F₂ max. 7450 N

End Fitting

Standard Dimensions

End Fitting

B24

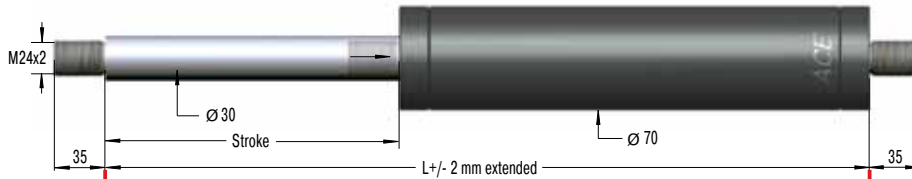

Stud Thread **B24**

D24

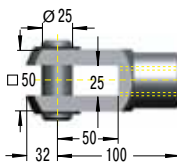

Clevis Fork **D24**
max. force 50 000 N

E24

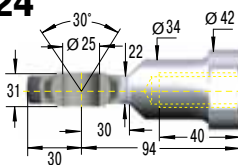

Swivel Eye **E24**
max. force 50 000 N

Dimensions

Type	Stroke mm	L extended
GS-70-100	100	320
GS-70-200	200	520
GS-70-300	300	720
GS-70-400	400	920
GS-70-500	500	1 120
GS-70-600	600	1 320
GS-70-700	700	1 520
GS-70-800	800	1 720

Ordering Example

GS-70-200-EE-8000

Type (Push Type) _____
 Body Ø (70 mm) _____
 Stroke (200 mm) _____
 Piston Rod End Fitting E24 _____
 Body End Fitting E24 _____
 Nominal Force F_1 8000 N _____

The end fittings are interchangeable.
 For mounting accessories see page 187.
 Standard gas spring with valve.

Rod Shroud
W24-70

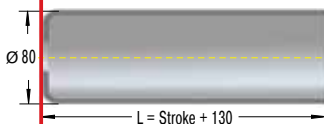

GS-70

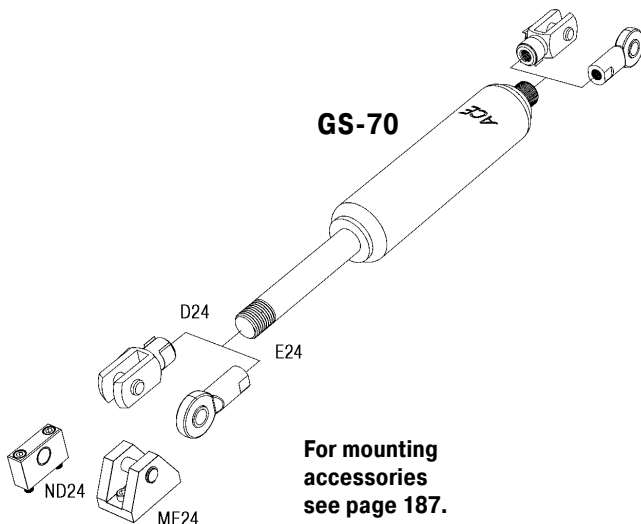

For mounting
accessories
see page 187.

Technical Data

On request: Without damping, special force curves, special lengths, alternative end fittings, wiper, stainless steel.

Available force range F_1 at 20 °C: 2000 N to 13 000 N

Mounting: In any position

Advice: We recommend mounting with piston rod downwards to take advantage of the built-in end position damping.

End position damping length: Approx. 10 mm

Material: Body: Black coated steel or zinc plated steel. Piston rod: With wear-resistant coating. End fittings: Zinc plated steel.

Progression: Approx. 25 %, F_2 max. 16 250 N

ACE offers **tandem gas springs** specially for heavy flaps and hoods with a large opening angle. These are characterised by a high initial force and low end force. The tandem gas springs have two pressure tubes with different extension forces and progression curves, and are therefore able to cover two force ranges. **The tandem gas springs are designed individually according to their use – free of charge by the ACE calculation service. They are manufactured especially for your application.** The force ranges are aligned precisely to each other and are adjusted to the required kinematics. Tandem gas springs are maintenance free and ready for installation. ACE tandem gas springs offer the best service life based on a piston rod with a hard wearing surface coating as well as an integrated grease chamber, which ensures constant lubrication of the seals. A comprehensive range of fitting parts ensures easy installation.

"Reduce the need for muscle power for comfortably opening heavy flaps!"

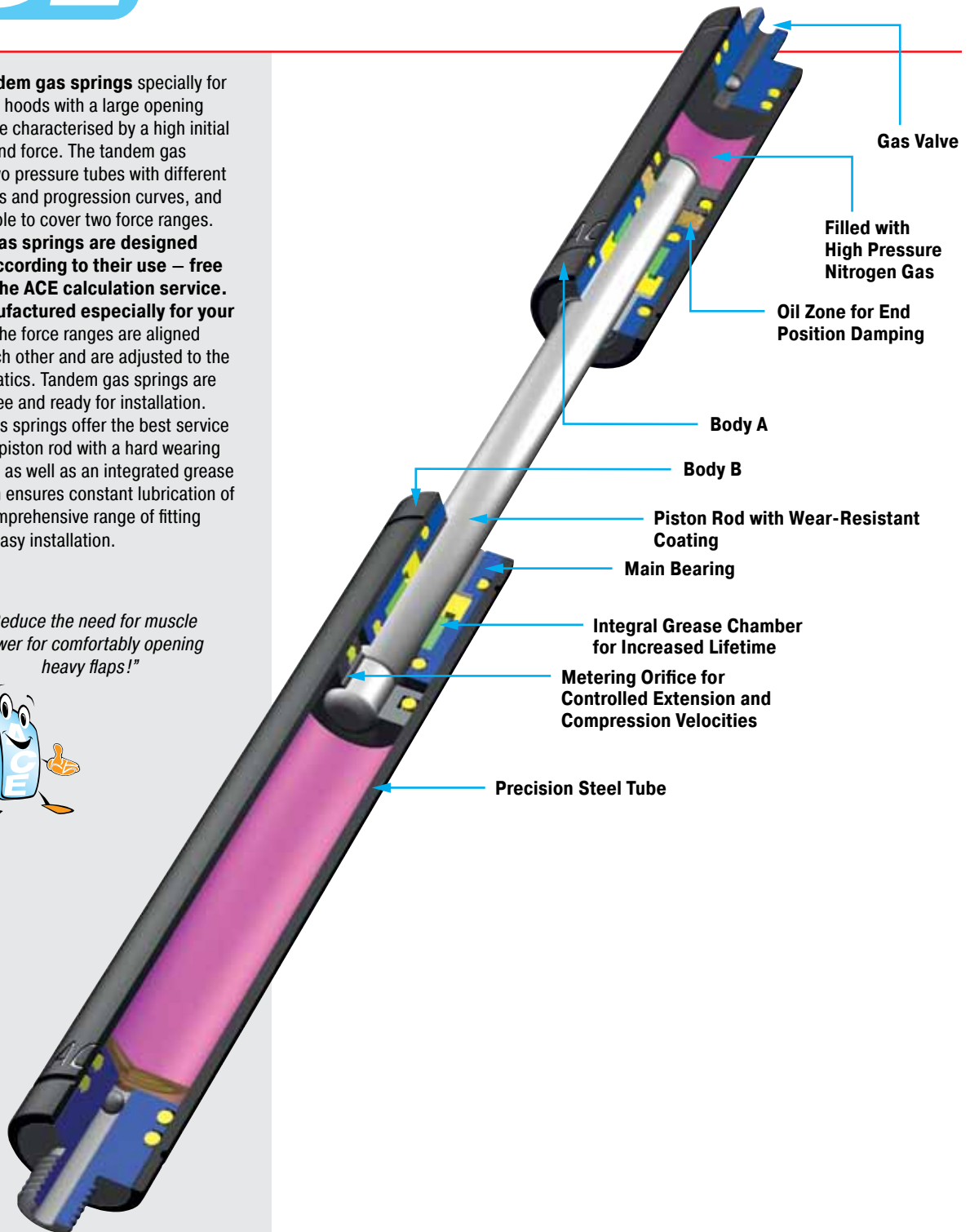

Operating fluid: Nitrogen gas and oil

Material: Piston rod: With wear-resistant coating. Bodies and end fittings: Zinc plated steel.

Mounting: According to calculation. Please adopt the mounting points determined by ACE.

Operating temperature range: -20 °C to 80 °C

On request: Material 1.4301/1.4305, AISI 304/303 (V2A) and material 1.4404/1.4571, AISI 316L/316Ti (V4A).



End Fitting

Standard Dimensions

End Fitting

A14

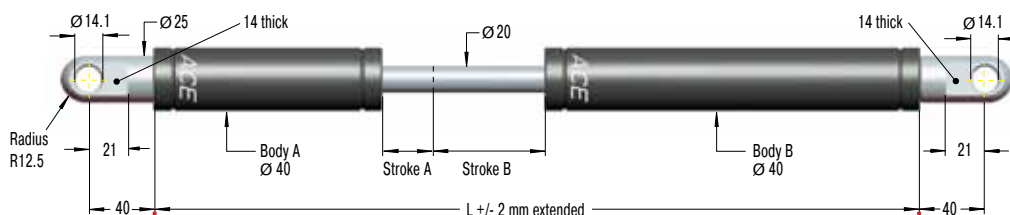

Eye A14
max. force 10 000 N

B14



Stud Thread B14

D14

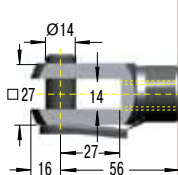

Clevis Fork D14
max. force 10 000 N

E14

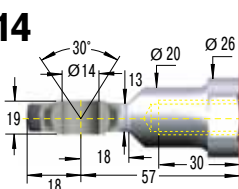

Swivel Eye E14
max. force 10 000 N

Dimensions

Type	Stroke A mm	Stroke B mm	L extended
GST-40-50-100	50	100	485
GST-40-50-150	50	150	585
GST-40-50-200	50	200	685
GST-40-70-250	70	250	825
GST-40-70-300	70	300	925
GST-40-70-350	70	350	1 025
GST-40-70-400	70	400	1 125

Ordering Example

GST-40-50-150-AD-900N-2500N

Type (Tandem Gas Spring) _____
 Body Ø (40 mm) _____
 Stroke A (50 mm) _____
 Stroke B (150 mm) _____
 Body A End Fitting, A14 _____
 Body B End Fitting, D14 _____
 Nominal Force Body A, 900 N _____
 Nominal Force Body B, 2500 N _____

The end fittings are interchangeable.
 These gas springs are tailored to the relevant application and are therefore not available ex stock.
 For mounting accessories see page 187.

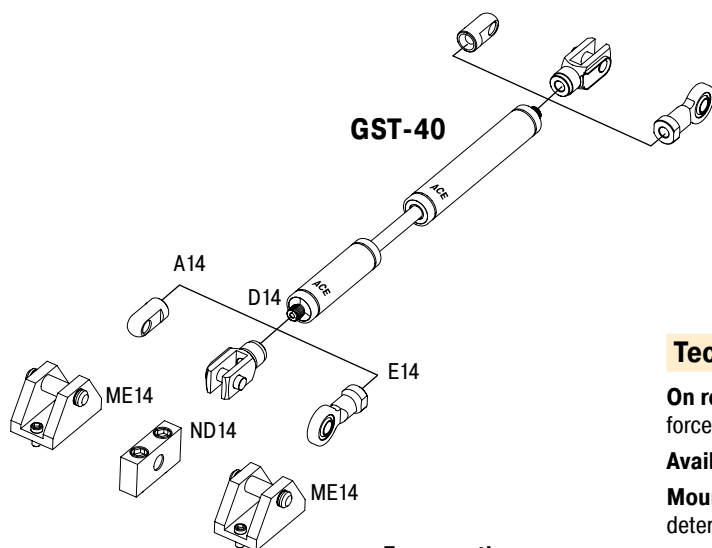

For mounting accessories see page 187.

Technical Data

On request: Without damping, standard end position damping, special force curves, special lengths, alternative end fittings, wiper.

Available force range F_1 at 20 °C: 300 N to 5000 N

Mounting: According to calculation. Please adopt the mounting points determined by ACE.

End position damping length: Application-specific end position damping and extension speed.

Material: Piston rod: With wear-resistant coating. Bodies and end fittings: Zinc plated steel.

Progression: According to calculation relating to your application.

Stainless steel gas springs (push type)
 Material 1.4301/1.4305, AISI 304/303 (V2A),
 Material 1.4404/1.4571, AISI 316L/316Ti (V4A)

In addition to the comprehensive range of industrial gas springs with valve, ACE also offers a wide range of industrial gas springs made of stainless steel with body diameters from 8 mm to 70 mm. This high-quality version is also available on request in all stroke lengths and possible extension forces. The comprehensive range of fitting parts ensures easy installation and makes the gas springs universal in use. Stainless steel industrial gas springs are used everywhere that raising and lowering is required. The standard type is filled with a special oil that conforms to the requirements **FDA 21 CFR 178.3570** of the food industry. Due to their special properties, **non-rusting and low magnetism**, they are the preferred equipment for medical and clean-room technology, the foodstuffs industry, electronics and shipbuilding sector.

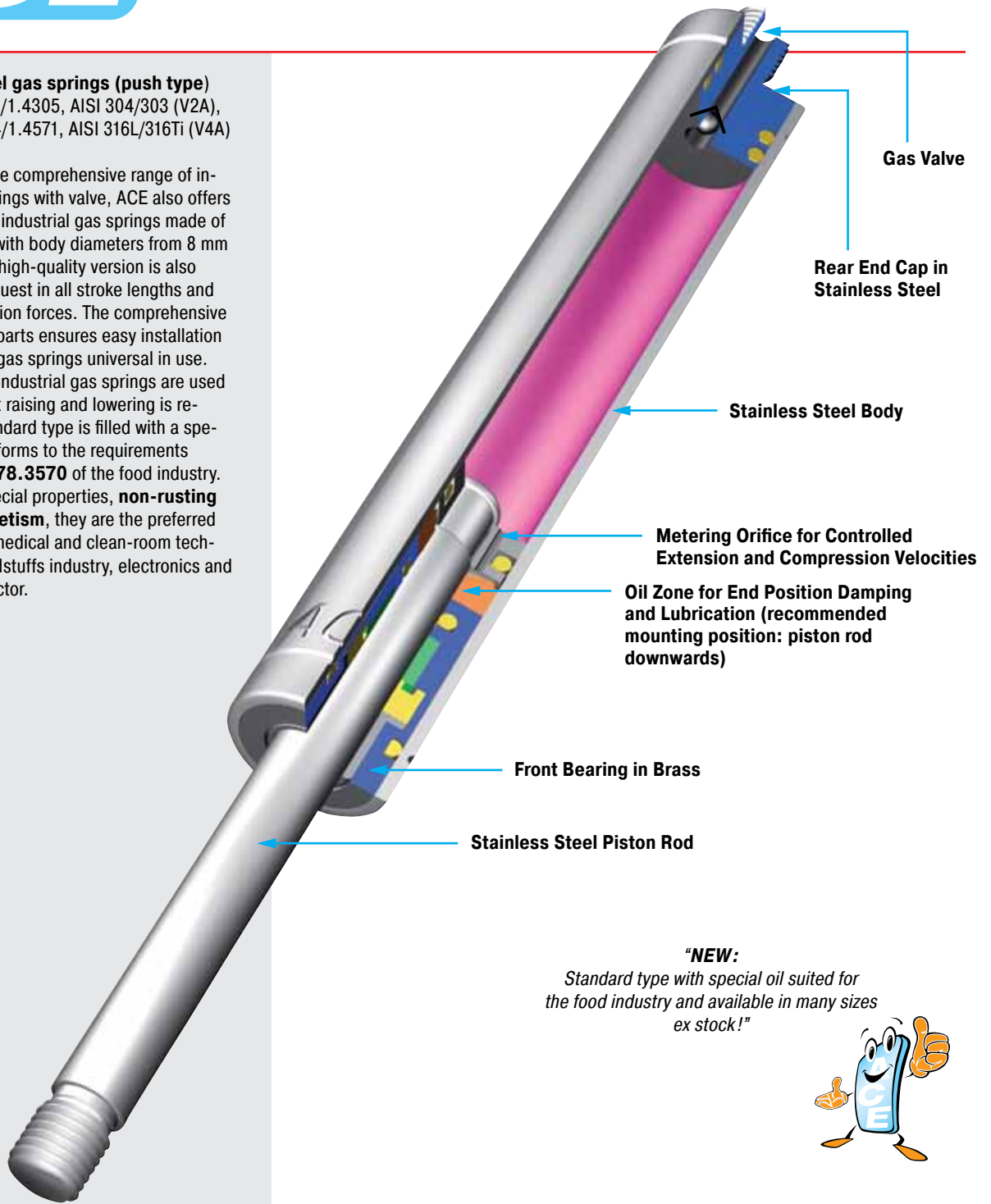

"NEW:
 Standard type with special oil suited for
 the food industry and available in many sizes
 ex stock!"



Operating fluid: Nitrogen gas and HLP oil according to DIN 51 524, part 2

Material: Piston rod, body and end fittings: Material 1.4301/1.4305, AISI 304/303 (V2A) or material 1.4404/1.4571, AISI 316L/316Ti (V4A).

Mounting: We recommend mounting with piston rod downwards to take advantage of the built-in end position damping.

Operating temperature range:
 -20 °C to 80 °C

On request: Without damping, strong end position damping, special force curves, wiper, special lengths, alternative end fittings.



Extension Forces 25 N to 100 N
(when Piston Rod Compressed up to 130 N)

End Fitting

Standard Dimensions

End Fitting

B3,5

A3,5-V4A

C3,5-V4A

D3,5-V4A

G3,5-V4A

Dimensions

Type	Stroke mm	L extended
GS-8-20-V4A	20	72
GS-8-30-V4A	30	92
GS-8-40-V4A	40	112
GS-8-50-V4A	50	132
GS-8-60-V4A	60	152
GS-8-80-V4A	80	192

Ordering Example

GS-8-30-AC-30-V4A

Type (Push Type) _____

Body Ø (8 mm) _____

Stroke (30 mm) _____

Piston Rod End Fitting A3,5-V4A _____

Body End Fitting C3,5-V4A _____

Nominal Force F₁ 30 N _____

Indicated by K.-No. on delivery _____

**The end fittings are interchangeable.
For mounting accessories see page 188.**

Stud Thread **B3,5**

Eye
A3,5-V4A
max. force 370 N

Angle Ball Joint
C3,5-V4A
max. force 370 N

Clevis Fork
D3,5-V4A
max. force 370 N

Ball Socket
G3,5-V4A
max. force 370 N

Adjuster Knob
DE-GAS-3,5
See page 149.

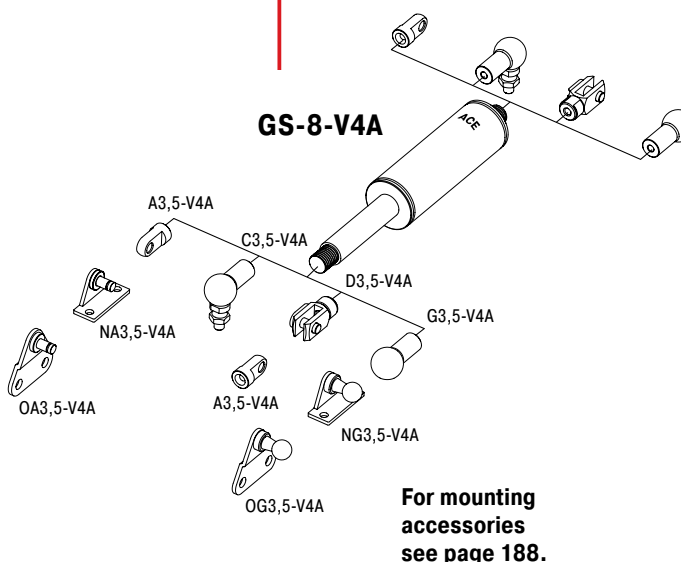

Technical Data

On request: Without damping, strong end position damping, special force curves, special end fittings.

Available force range F₁ at 20 °C: 25 N to 100 N

Mounting: We recommend mounting with piston rod downwards to take advantage of the built-in end position damping.

End position damping length: Approx. 5 mm

Material: Piston rod, body and end fittings: Material 1.4404/1.4571, AISI 316L/316Ti (V4A).

Progression: Approx. 27 %, F₂ max. 130 N

Extension Forces 30 N to 100 N
(when Piston Rod Compressed up to 115 N)

End Fitting

Standard Dimensions

End Fitting

B3,5

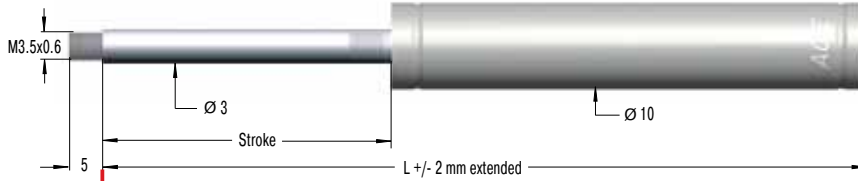

Stud Thread **B3,5**

A3,5-V4A

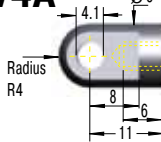

Eye
A3,5-V4A
max. force 370 N

C3,5-V4A

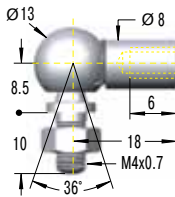

Angle Ball Joint
C3,5-V4A
max. force 370 N

D3,5-V4A

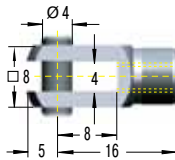

Clevis Fork
D3,5-V4A
max. force 370 N

G3,5-V4A

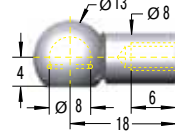

Ball Socket
G3,5-V4A
max. force 370 N

Dimensions

Type	Stroke mm	L extended
GS-10-20-V4A	20	72
GS-10-30-V4A	30	92
GS-10-40-V4A	40	112
GS-10-50-V4A	50	132
GS-10-60-V4A	60	152
GS-10-80-V4A	80	192

Ordering Example

GS-10-30-AC-30-V4A

Type (Push Type) _____
 Body Ø (10 mm) _____
 Stroke (30 mm) _____
 Piston Rod End Fitting A3,5-V4A _____
 Body End Fitting C3,5-V4A _____
 Nominal Force F₁ 30 N _____
 Indicated by K.-No. on delivery _____

The end fittings are interchangeable.
For mounting accessories see page 188.

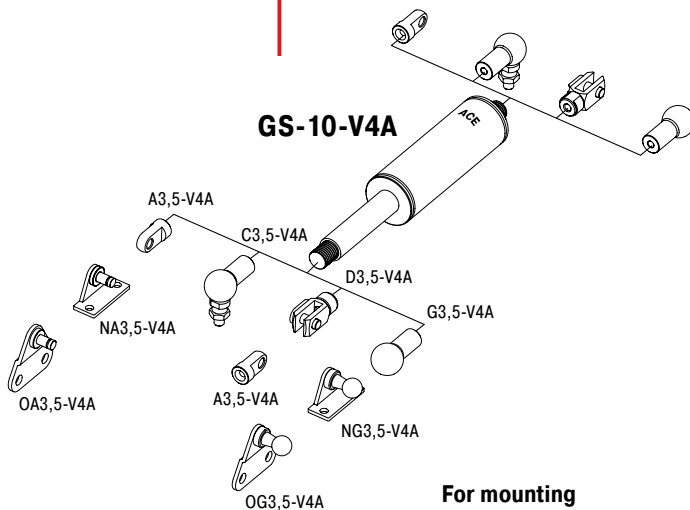

For mounting accessories see page 188.

Technical Data

On request: Without damping, strong end position damping, special force curves, special end fittings.

Available force range F₁ at 20 °C: 30 N to 100 N

Mounting: We recommend mounting with piston rod downwards to take advantage of the built-in end position damping.

End position damping length: Approx. 5 mm

Material: Piston rod, body and end fittings: Material 1.4404/1.4571, AISI 316L/316Ti (V4A).

Progression: Approx. 12 %, F₂ max. 115 N



Extension Forces 25 N to 200 N
(when Piston Rod Compressed up to 235 N)

End Fitting

Standard Dimensions

End Fitting

B3,5

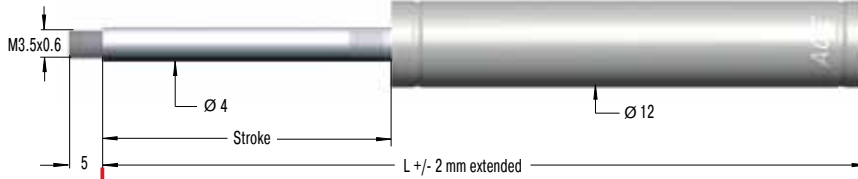

Stud Thread **B3,5**

A3,5-V4A

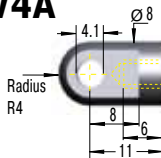

Eye
A3,5-V4A
max. force 370 N

C3,5-V4A

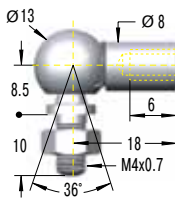

Angle Ball Joint
C3,5-V4A
max. force 370 N

D3,5-V4A

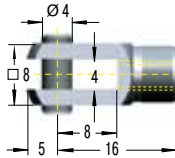

Clevis Fork
D3,5-V4A
max. force 370 N

G3,5-V4A

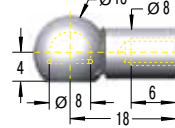

Ball Socket
G3,5-V4A
max. force 370 N

Dimensions

Type	Stroke mm	L extended
GS-12-20-V4A	20	72
GS-12-30-V4A	30	92
GS-12-40-V4A	40	112
GS-12-50-V4A	50	132
GS-12-60-V4A	60	152
GS-12-80-V4A	80	192
GS-12-100-V4A	100	232
GS-12-120-V4A	120	272
GS-12-150-V4A	150	332

Ordering Example

GS-12-100-AA-30-V4A

Type (Push Type) _____
 Body Ø (12 mm) _____
 Stroke (100 mm) _____
 Piston Rod End Fitting A3,5-V4A _____
 Body End Fitting A3,5-V4A _____
 Nominal Force F₁ 30 N _____
 Indicated by K.-No. on delivery _____

The end fittings are interchangeable.
For mounting accessories see page 188.



Adjuster Knob
DE-GAS-3,5
See page 149.

Issue 7.2014. Specifications subject to change

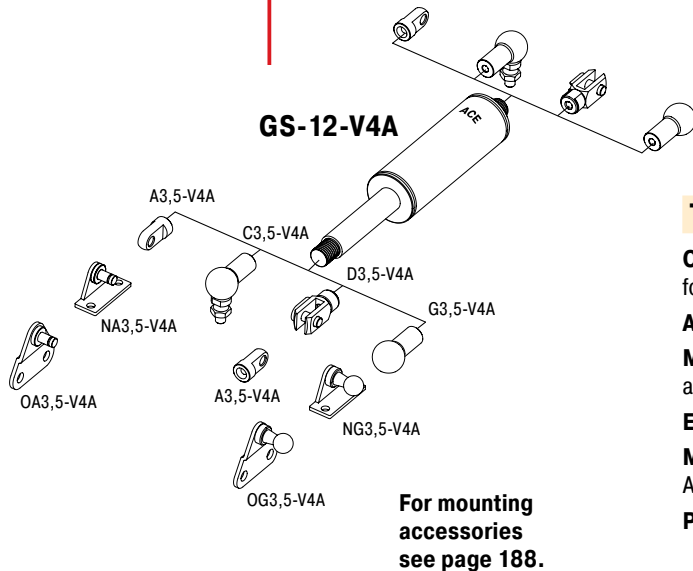

For mounting
accessories
see page 188.

Technical Data

On request: Without damping, strong end position damping, special force curves, special end fittings.

Available force range F₁ at 20 °C: 25 N to 200 N

Mounting: We recommend mounting with piston rod downwards to take advantage of the built-in end position damping.

End position damping length: Approx. 10 mm

Material: Piston rod, body and end fittings: Material 1.4404/1.4571, AISI 316L/316Ti (V4A).

Progression: Approx. 18 %, F₂ max. 235 N

Extension Forces 40 N to 400 N
(when Piston Rod Compressed up to 535 N)

End Fitting

Standard Dimensions

End Fitting

B5

A5-VA

C5-VA

D5-VA

E5-VA

G5-VA

Rod Shroud W5-15-VA

Dimensions

Type	Stroke mm	L extended
GS-15-20-VA	20	74
GS-15-40-VA	40	114
GS-15-50-VA	50	134
GS-15-60-VA	60	154
GS-15-80-VA	80	194
GS-15-100-VA	100	234
GS-15-120-VA	120	274
GS-15-150-VA	150	334

Ordering Example

Type (Push Type) _____

Body Ø (15.6 mm) _____

Stroke (150 mm) _____

Piston Rod End Fitting A5-VA _____

Body End Fitting C5-VA _____

Nominal Force F₁ 150 N _____

Indicated by K.-No. on delivery _____

GS-15-150-AC-150-VA

The end fittings are interchangeable.
Strokes also available up to 150 mm ex stock.
For mounting accessories see page 188.

Stud Thread B5

Eye A5-VA
max. force 490 N

Angle Ball Joint C5-VA
max. force 430 N

Clevis Fork D5-VA
max. force 490 N

Swivel Eye E5-VA
max. force 490 N

Ball Socket G5-VA
max. force 430 N

Adjuster Knob DE-GAS-5
See page 149.

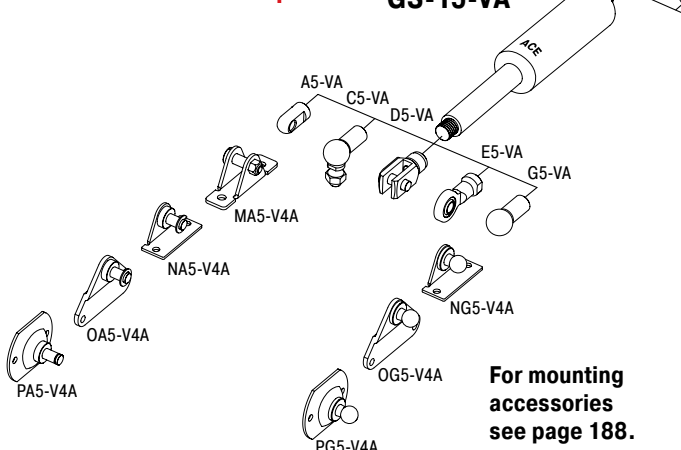

For mounting accessories see page 188.

Technical Data

On request: Without damping, strong end position damping, special force curves, special lengths, alternative end fittings, wiper. Gas springs and accessories: Material 1.4404/1.4571, AISI 316L/316Ti (V4A).

Available force range F₁ at 20 °C: 40 N to 400 N

Mounting: We recommend mounting with piston rod downwards to take advantage of the built-in end position damping.

End position damping length: Approx. 20 mm (depending on the stroke)

Material: Piston rod, body and end fittings: Material 1.4301/1.4305, AISI 304/303 (V2A).

Progression: Approx. 34 %, F₂ max. 535 N

Extension Forces 50 N to 700 N
(when Piston Rod Compressed up to 930 N)

End Fitting

Standard Dimensions

End Fitting

B8

M8x1.25

Ø 8

Stroke

Ø 19

L +/- 2 mm extended

Dimensions

Type	Stroke mm	L extended
GS-19-50-VA	50	164
GS-19-100-VA	100	264
GS-19-150-VA	150	364
GS-19-200-VA	200	464
GS-19-250-VA	250	564
GS-19-300-VA	300	664

Ordering Example

GS-19-150-AC-600-VA

Type (Push Type) _____

Body Ø (19 mm) _____

Stroke (150 mm) _____

Piston Rod End Fitting A8-VA _____

Body End Fitting C8-VA _____

Nominal Force F₁ 600 N _____

Indicated by K.-No. on delivery _____

The end fittings are interchangeable.
Strokes also available up to 300 mm ex stock.
For mounting accessories see page 189.

Stud Thread B8

Eye A8-VA
max. force 1560 N

Angle Ball Joint C8-VA
max. force 1140 N

Clevis Fork D8-VA
max. force 1560 N

Swivel Eye E8-VA
max. force 1560 N

Ball Socket G8-VA
max. force 1140 N

Adjuster Knob DE-GAS-8
See page 149.

Rod Shroud W8-19-VA

Ø 23

L = Stroke + 30

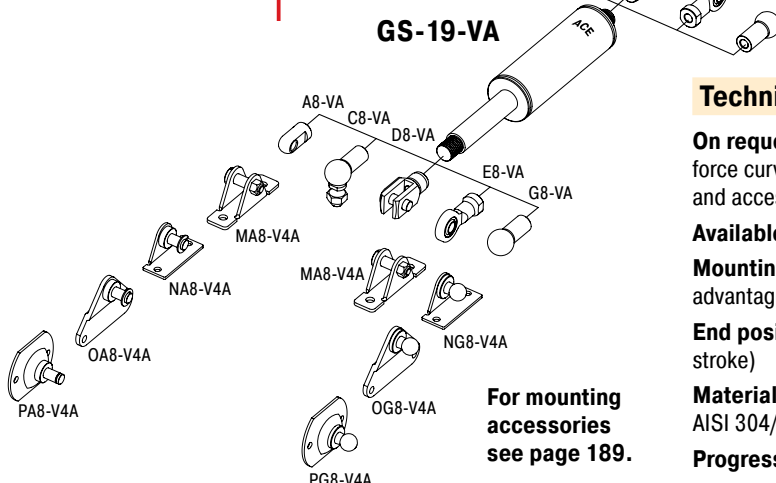

Technical Data

On request: Without damping, strong end position damping, special force curves, special lengths, alternative end fittings, wiper. Gas springs and accessories: Material 1.4404/1.4571, AISI 316L/316Ti (V4A).

Available force range F₁ at 20 °C: 50 N to 700 N

Mounting: We recommend mounting with piston rod downwards to take advantage of the built-in end position damping.

End position damping length: Approx. 20 mm (depending on the stroke)

Material: Piston rod, body and end fittings: Material 1.4301/1.4305, AISI 304/303 (V2A).

Progression: Approx. 33 %, F₂ max. 930 N

For mounting accessories see page 189.

Extension Forces 150 N to 2500 N
(when Piston Rod Compressed up to 3800 N)

End Fitting

Standard Dimensions

End Fitting

B10

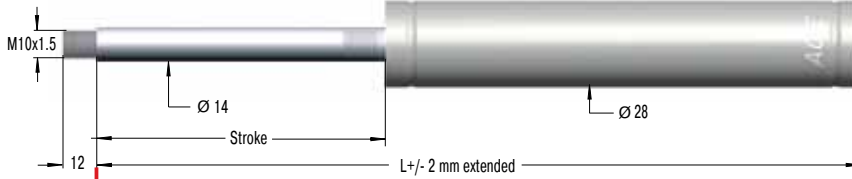

Stud Thread B10

A10-VA

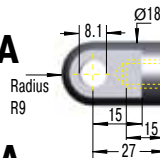

Eye A10-VA max. force 3800 N

C10-VA

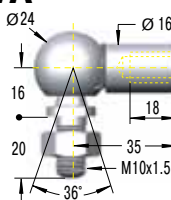

Angle Ball Joint C10-VA max. force 1750 N

D10-VA

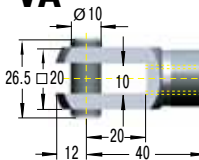

Clevis Fork D10-VA max. force 3800 N

E10-VA

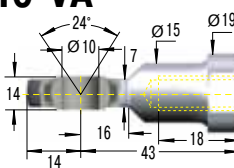

Swivel Eye E10-VA max. force 3800 N

Dimensions

Type	Stroke mm	L extended
GS-28-100-VA	100	262
GS-28-150-VA	150	362
GS-28-200-VA	200	462
GS-28-250-VA	250	562
GS-28-300-VA	300	662
GS-28-350-VA	350	762
GS-28-400-VA	400	862
GS-28-450-VA	450	962
GS-28-500-VA	500	1 062
GS-28-550-VA	550	1 162
GS-28-600-VA	600	1 262
GS-28-650-VA	650	1 362

Ordering Example

GS-28-150-EE-1200-VA

Type (Push Type) _____
 Body Ø (28 mm) _____
 Stroke (150 mm) _____
 Piston Rod End Fitting E10-VA _____
 Body End Fitting E10-VA _____
 Nominal Force F₁ 1200 N _____
 Indicated by K.-No. on delivery _____

The end fittings are interchangeable.
 Strokes also available up to 400 mm ex stock
 and up to 750 mm on request.
 For mounting accessories see page 189.

Rod Shroud W10-28-VA

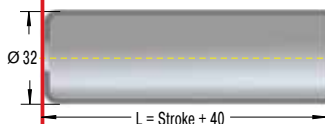

Adjuster Knob DE-GAS-10 See page 149.

Issue 7.2014. Specifications subject to change

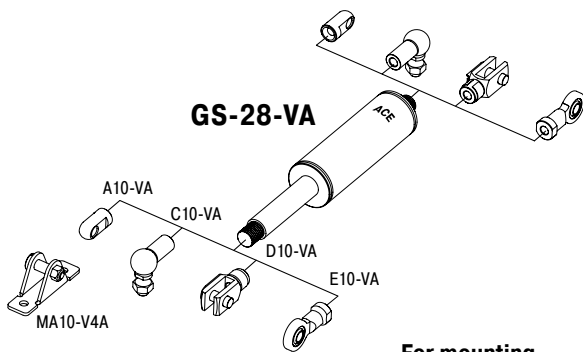

For mounting
accessories
see page 189.

Technical Data

On request: Without damping, strong end position damping, special force curves, special lengths, alternative end fittings, wiper. Gas springs and accessories: Material 1.4404/1.4571, AISI 316L/316Ti (V4A).

Available force range F₁ at 20 °C: 150 N to 2500 N

Mounting: We recommend mounting with piston rod downwards to take advantage of the built-in end position damping.

End position damping length: Approx. 20 mm (depending on the stroke)

Material: Piston rod, body and end fittings: Material 1.4301/1.4305, AISI 304/303 (V2A).

Progression: Approx. 52 %, F₂ max. 3800 N

Extension Forces 500 N to 5000 N
(when Piston Rod Compressed up to 7000 N)

End Fitting

Standard Dimensions

End Fitting

B14

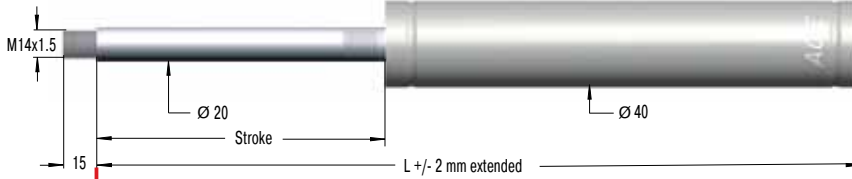

Stud Thread B14

A14-VA

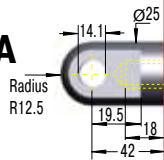

Dimensions

Type	Stroke mm	L extended
GS-40-100-VA	100	317
GS-40-150-VA	150	417
GS-40-200-VA	200	517
GS-40-300-VA	300	717
GS-40-400-VA	400	917
GS-40-500-VA	500	1 117
GS-40-600-VA	600	1 317

Eye A14-VA max. force 7000 N

C14-VA

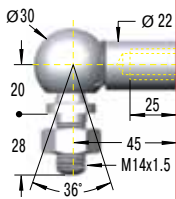

Angle Ball Joint C14-VA max. force 3200 N

D14-VA

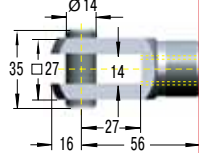

Clevis Fork D14-VA max. force 7000 N

E14-VA

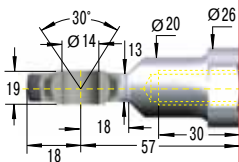

Swivel Eye E14-VA max. force 7000 N

Ordering Example

GS-40-150-DD-3500-VA

Type (Push Type) _____
 Body Ø (40 mm) _____
 Stroke (150 mm) _____
 Piston Rod End Fitting D14-VA _____
 Body End Fitting D14-VA _____
 Nominal Force F₁ 3500 N _____
 Indicated by K.-No. on delivery _____

The end fittings are interchangeable.
 Strokes also available up to 1000 mm.
 For mounting accessories see page 190.

Rod Shroud W14-40-VA

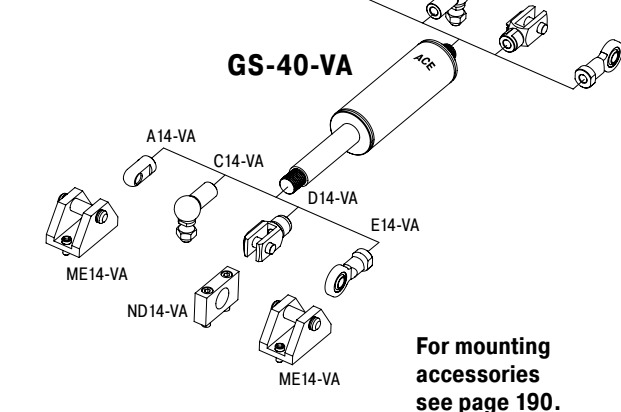
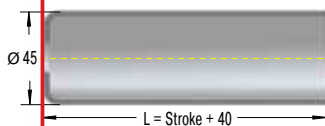

For mounting
 accessories
 see page 190.

Adjuster Knob DE-GAS-14 See page 149.

Technical Data

On request: Without damping, strong end position damping, special force curves, special lengths, alternative end fittings, wiper. Gas springs and accessories: Material 1.4404/1.4571, AISI 316L/316Ti (V4A).

Available force range F₁ at 20 °C: 500 N to 5000 N

Mounting: We recommend mounting with piston rod downwards to take advantage of the built-in end position damping.

End position damping length: Approx. 30 mm (depending on the stroke)

Material: Piston rod, body and end fittings: Material 1.4301/1.4305, AISI 304/303 (V2A).

Progression: Approx. 40 %, F₂ max. 7000 N

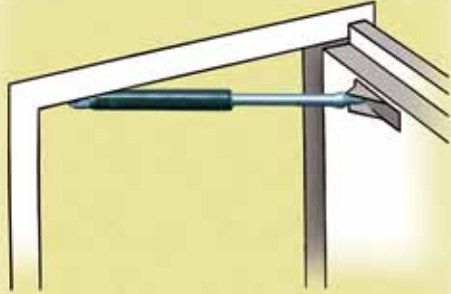

Doors open and close safely

ACE industrial gas springs make opening and closing doors of rescue helicopters easier.

The maintenance-free, sealed systems are installed in the access doors of helicopters of the type EC 135. There, they allow the crew to enter or exit the helicopter quickly, thus contributing to enhanced safety.

The **GS-19-300-CC** gas springs provide a defined retraction speed and secure engagement of the door lock. The integrated end position damper allows gentle closing of the door and saves wear and tear on the valuable, lightweight material.



Industrial gas springs: For safe entry and exit

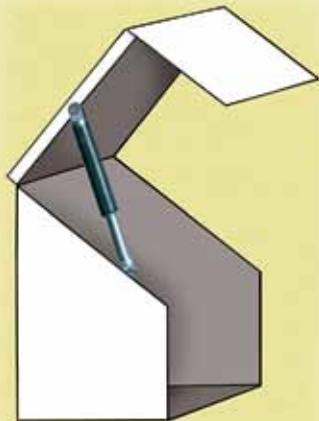

Protection under the hood

ACE industrial gas springs prevent injuries during maintenance work on harvesting machines.

The blades of corn pickers are arranged under plastic hoods, which assure proper material flow within the machine. For maintenance purposes, the hoods, weighing about 7 kg, must be lifted up. To protect maintenance personnel from injury by falling hoods, they are kept in the open position by industrial gas springs of the type **GS-22-250-DD**.

Another advantage they offer is their stability under rough operating conditions due to their wear-resistant coating on the piston rod and the coated housing.



Enhanced protection: Industrial gas springs secure heavy hoods

Industrial traction gas springs are maintenance-free and ready to install. They are available ex-stock with body diameters from 15 mm to 40 mm and forces from 30 N to 5000 N with valve. **ACE traction gas springs offer a long service life due to the hard-chromed piston rod and integral sliding bearing.** They can be installed in any position. The traction force can be subsequently adjusted by means of the valve. The comprehensive range of fitting parts ensures easy installation and makes the traction gas springs universal in use. They supply the muscle force and enable the controlled raising and lowering of covers, hoods, flaps etc. With the free ACE calculation service, the traction gas springs are designed with mounting points to fit the individual application, and can be delivered ex-stock as express deliveries within 24 hours.

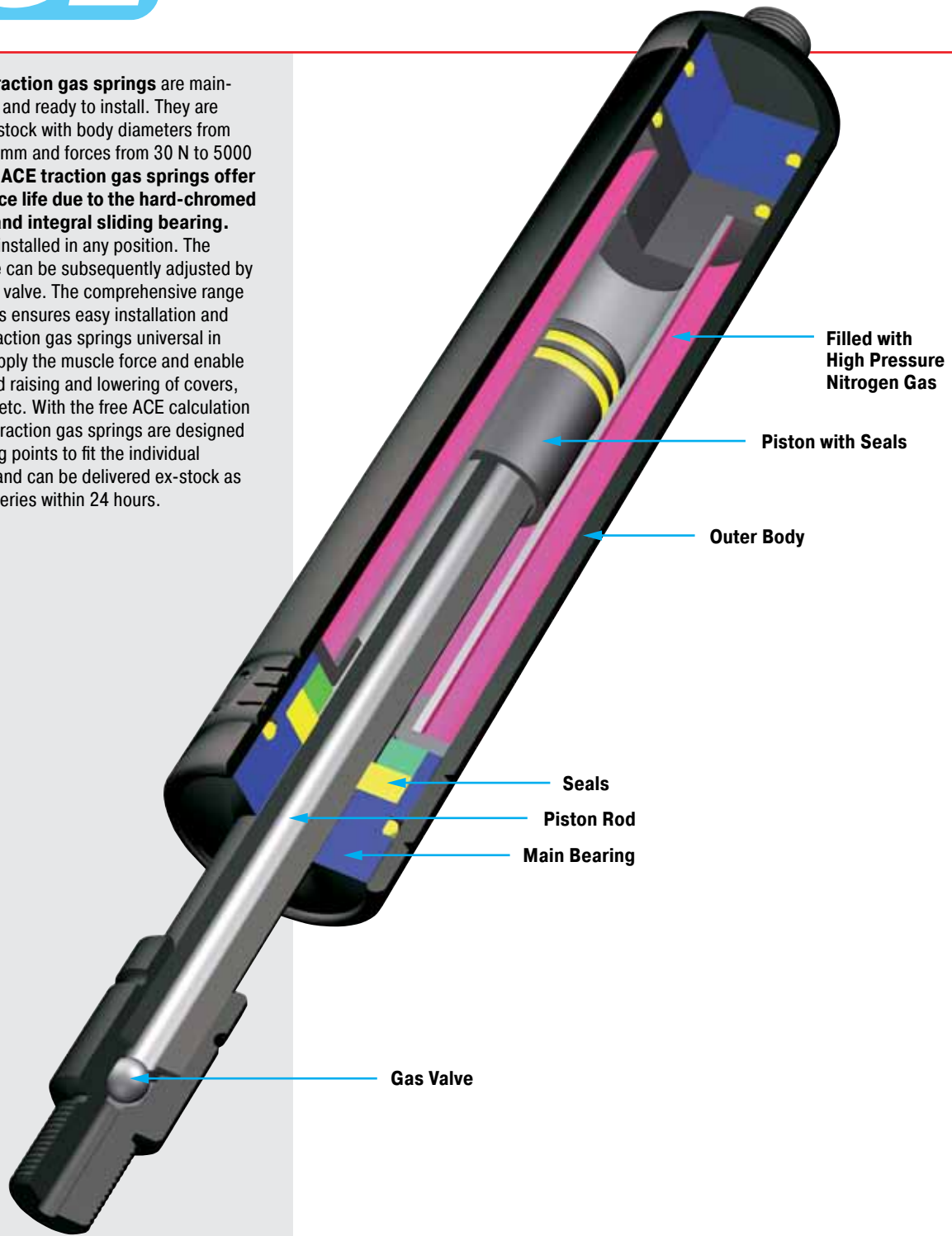

Function: ACE industrial traction gas springs are maintenance-free, closed systems, which are filled with pressurised nitrogen gas. Compared to the push type, ACE traction gas springs work in the reverse way. The piston rod is retracted by the gas pressure in the cylinder. The surface of the piston ring between the piston rod and the inner tube determines the force of the gas spring. Traction gas springs are always mounted with the stroke fully compressed.

Operating fluid: Nitrogen gas

Mounting: In any position

Operating temperature range:
-20 °C to 80 °C

On request: Special force curves, special lengths, alternative seals and end fittings.



Traction (Pull) Forces 50 N to 150 N
(when Piston Rod Extended up to 185 N)

End Fitting

Standard Dimensions

End Fitting

Dimensions

Type	Stroke mm	L retracted
GZ-15-20	20	87
GZ-15-40	40	107
GZ-15-50	50	117
GZ-15-60	60	127
GZ-15-80	80	147
GZ-15-100	100	167
GZ-15-120	120	187
GZ-15-150	150	217

Ordering Example

GZ-15-150-AC-150

Type (Pull Type) _____
 Body Ø (15 mm) _____
 Stroke (150 mm) _____
 Piston Rod End Fitting A3,5 _____
 Body End Fitting C3,5 _____
 Traction Force F_1 150 N _____

The end fittings are interchangeable and must be positively secured by the customer to prevent unscrewing (i.e. Loctite). For mounting accessories see page 185.

End Fitting Details:

- A3,5:** Eye A3,5 max. force 370 N
- B3,5:** Stud Thread B3,5
- C3,5:** Angle Ball Joint C3,5 max. force 370 N
- D3,5:** Clevis Fork D3,5 max. force 370 N
- E3,5:** Swivel Eye E3,5 max. force 370 N
- G3,5:** Ball Socket G3,5 max. force 370 N
- DE-GAS-3,5:** Adjuster Knob DE-GAS-3,5 See page 149.

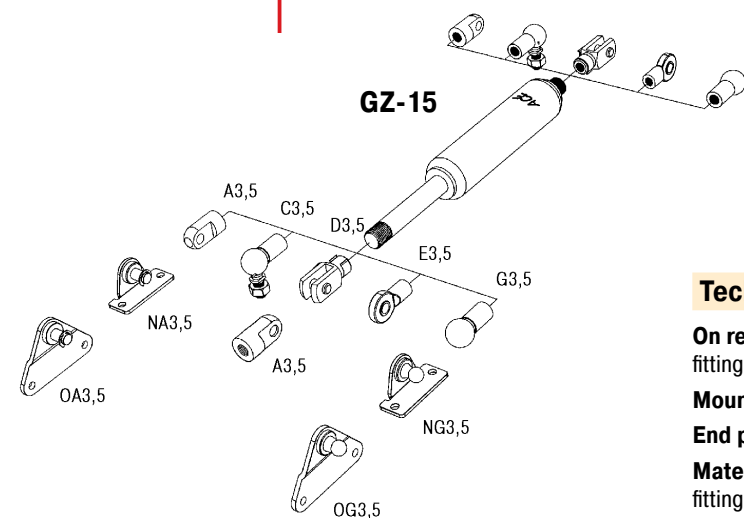

For mounting accessories see page 185.

Technical Data

- On request:** Special force curves, special lengths, alternative end fittings, rod shroud.
- Mounting:** In any position. Install mechanical stop in extended position.
- End position damping length:** Without damping
- Material:** Piston rod: Hard chrome plated. Body: Black coated. End fittings: Zinc plated steel.
- Progression:** Approx. 23 %, F_2 max. 185 N
- Available traction force range F_1 at 20 °C:** 50 N to 150 N
- Note:** Lifetime approx. 2000 m

Traction (Pull) Forces 30 N to 300 N
(when Piston Rod Extended up to 330 N)

End Fitting

Standard Dimensions

End Fitting



Dimensions

Type	Stroke mm	L retracted
GZ-19-30	30	112
GZ-19-50	50	132
GZ-19-100	100	182
GZ-19-150	150	232
GZ-19-200	200	282
GZ-19-250	250	332

Ordering Example

GZ-19-150-AC-250

Type (Pull Type) _____
 Body Ø (19 mm) _____
 Stroke (150 mm) _____
 Piston Rod End Fitting A8 _____
 Body End Fitting C8 _____
 Traction Force F_1 250 N _____

The end fittings are interchangeable and must be positively secured by the customer to prevent unscrewing (i.e. Loctite).
 For mounting accessories see page 186.

B8

C8

D8

E8

G8

Rod Shroud W8-19

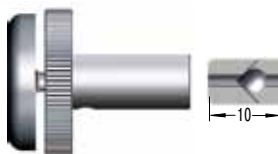

Adjuster Knob DE-GAS-8

See page 149.

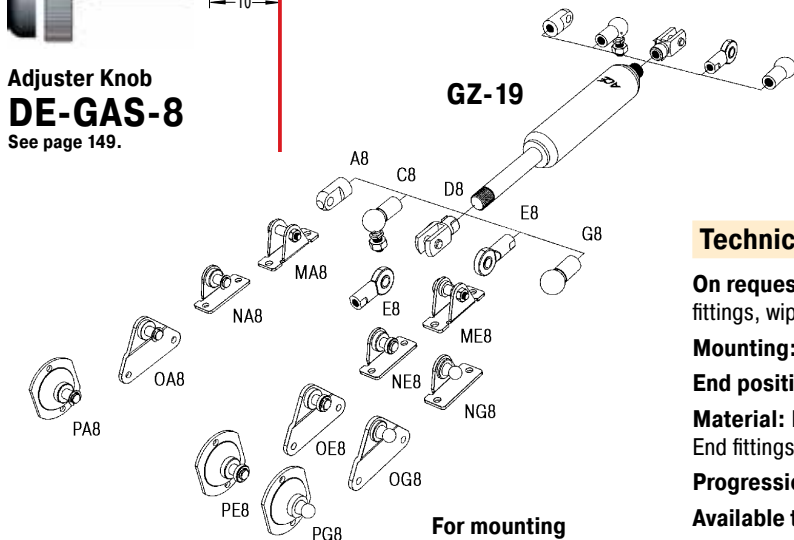

For mounting accessories see page 186.

Technical Data

On request: Special force curves, special lengths, alternative end fittings, wiper, stainless steel.

Mounting: In any position. Install mechanical stop in extended position.

End position damping length: Without damping.

Material: Piston rod: Hard chrome plated. Body: Black coated. End fittings: Zinc plated steel.

Progression: Approx. 10 %, F_2 max. 330 N

Available traction force range F_1 at 20 °C: 30 N to 300 N

Note: Lifetime approx. 2000 m

Traction (Pull) Forces 150 N to 1200 N
(when Piston Rod Extended up to 1440 N)

End Fitting

Standard Dimensions

End Fitting

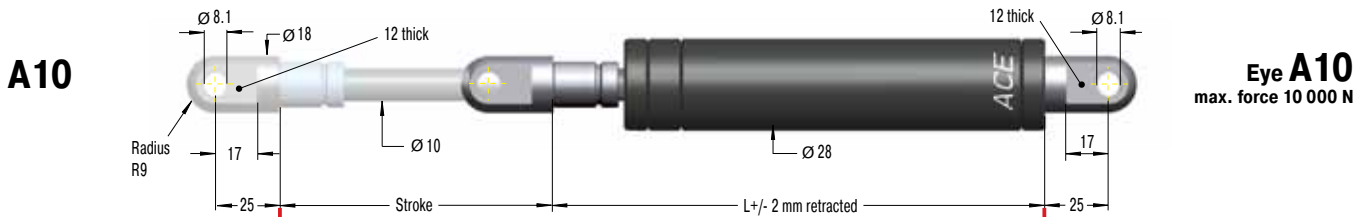

B10

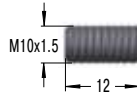

Stud Thread B10

C10

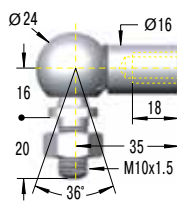

Angle Ball Joint C10

max. force 1800 N

D10

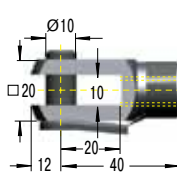

Clevis Fork D10

max. force 10 000 N

E10

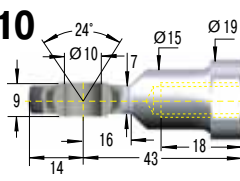

Swivel Eye E10

max. force 10 000 N

Dimensions		
Type	Stroke mm	L retracted
GZ-28-30	30	130
GZ-28-50	50	150
GZ-28-100	100	200
GZ-28-150	150	250
GZ-28-200	200	300
GZ-28-250	250	350
GZ-28-300	300	400
GZ-28-350	350	450
GZ-28-400	400	500
GZ-28-450	450	550
GZ-28-500	500	600
GZ-28-550	550	650
GZ-28-600	600	700
GZ-28-650	650	750

Ordering Example

GZ-28-150-EE-800

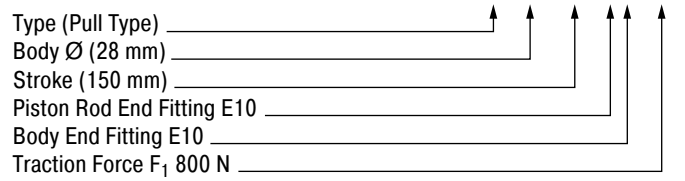

The end fittings are interchangeable and must be positively secured by the customer to prevent unscrewing (i.e. Loctite).
For mounting accessories see page 186.

Rod Shroud W10-28

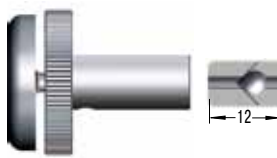
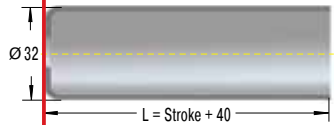

Adjuster Knob DE-GAS-10

See page 149.

GZ-28

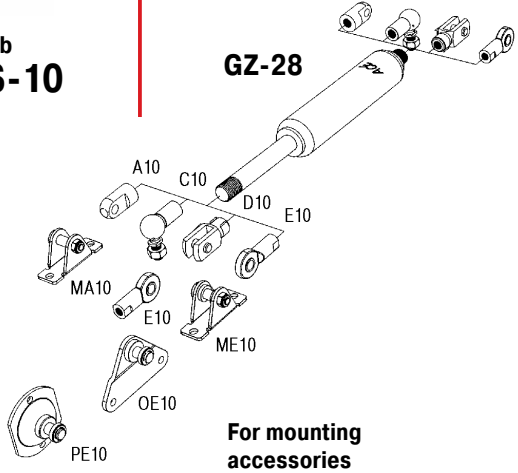

For mounting accessories see page 186.

Technical Data

- On request:** Special force curves, special lengths, alternative end fittings, wiper, stainless steel.
- Mounting:** In any position. Install mechanical stop in extended position.
- End position damping length:** Without damping.
- Material:** Piston rod: Hard chrome plated. Body: Black coated. End fittings: Zinc plated steel.
- Progression:** Approx. 20 %, F₂ max. 1440 N
- Available traction force range F₁ at 20 °C:** 150 N to 1200 N
- Note:** Lifetime approx. 2000 m

Issue 7.2014. Specifications subject to change

Traction (Pull) Forces 400 N to 5000 N
(when Piston Rod Extended up to 7000 N)

End Fitting

Standard Dimensions

End Fitting

A14

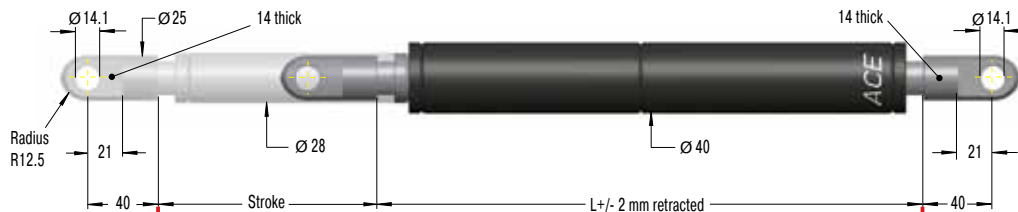

Eye A14
max. force 10 000 N

B14



Dimensions

Type	Stroke mm	L retracted
GZ-40-100	100	250
GZ-40-150	150	325
GZ-40-200	200	400
GZ-40-250	250	475
GZ-40-300	300	550
GZ-40-400	400	700
GZ-40-500	500	850
GZ-40-600	600	1 000

Stud Thread B14

C14

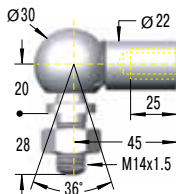

Angle Ball Joint C14
max. force 3200 N

D14

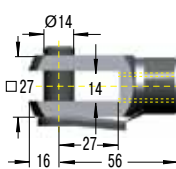

Clevis Fork D14
max. force 10 000 N

E14

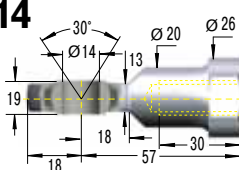

Swivel Eye E14
max. force 10 000 N

Ordering Example

GZ-40-150-EE-800

Type (Pull Type) _____
Body Ø (40 mm) _____
Stroke (150 mm) _____
Piston Rod End Fitting E14 _____
Body End Fitting E14 _____
Traction Force F_1 800 N _____

The end fittings are interchangeable and must be positively secured by the customer to prevent unscrewing (i.e. Loctite).
For mounting accessories see page 187.

Rod Shroud W14-40

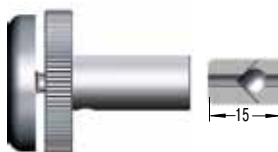
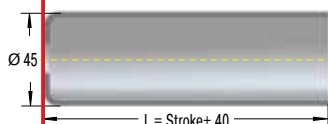

Adjuster Knob DE-GAS-14
See page 149.

GZ-40

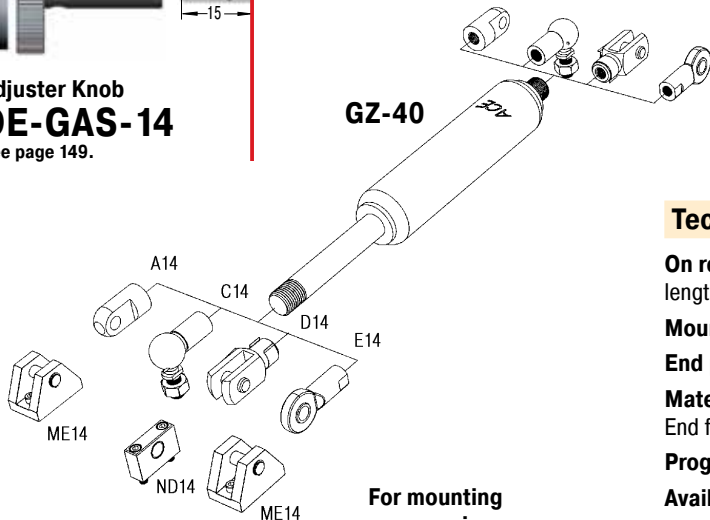

For mounting accessories see page 187.

Technical Data

On request: Increased traction force, special force curves, special lengths, alternative end fittings, wiper, stainless steel.

Mounting: In any position. Install mechanical stop in extended position.

End position damping length: Without damping

Material: Piston rod: Hard chrome plated. Body: Black coated. End fittings: Zinc plated steel.

Progression: Approx. 40 %, F_2 max. 7000 N

Available traction force range F_1 at 20 °C: 400 N to 5000 N

Note: Lifetime approx. 2000 m

Stainless steel industrial traction gas springs

Material 1.4301/1.4305, AISI 304/303 (V2A)
 Material 1.4404/1.4571, AISI 316L/316Ti (V4A)

In addition to the comprehensive range of industrial gas springs with valve, ACE also offers a wide range of industrial traction gas springs made of stainless steel with body diameters from 15 mm to 40 mm. This high-quality version is also available on request in all stroke lengths and possible extension forces. The comprehensive range of fitting parts ensures easy installation and makes the gas traction springs universal in use. Stainless steel traction gas springs are used everywhere that raising and lowering is required. Due to their special properties, **non-rusting and low magnetism**, they are the preferred equipment for medical and clean-room technology, the foodstuffs industry, electronics and shipbuilding sector.

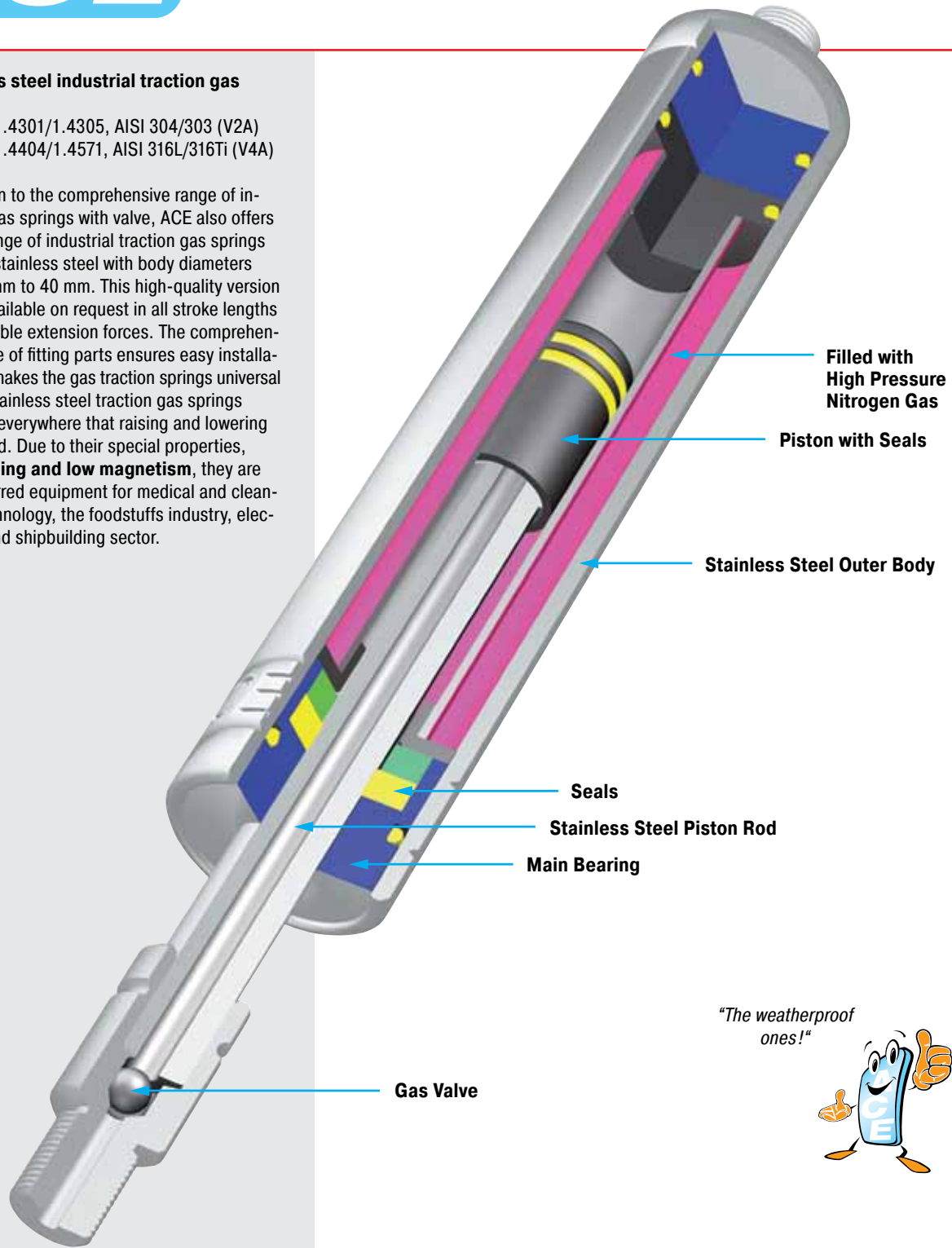

"The weatherproof ones!"



Issue 7.2014 Specifications subject to change

Operating fluid: Nitrogen gas

Material: Piston rod, body and end fittings: Material 1.4301/1.4305, AISI 304/303 (V2A) and material 1.4404/1.4571, AISI 316L/316Ti (V4A).

Mounting: In any position

Operating temperature range:
 -20 °C to 80 °C

On request: Special force curves, special lengths, alternative seals, wiper.



Traction (Pull) Forces 50 N to 150 N
(when Piston Rod Extended up to 185 N)

End Fitting

Standard Dimensions

End Fitting

B3,5

Stud Thread **B3,5**

A3,5-V4A

Eye
A3,5-V4A
max. force 370 N

C3,5-V4A

Angle Ball Joint
C3,5-V4A
max. force 370 N

D3,5-V4A

Clevis Fork
D3,5-V4A
max. force 370 N

G3,5-V4A

Ball Socket
G3,5-V4A
max. force 370 N

Adjuster Knob
DE-GAS-3,5
See page 149.

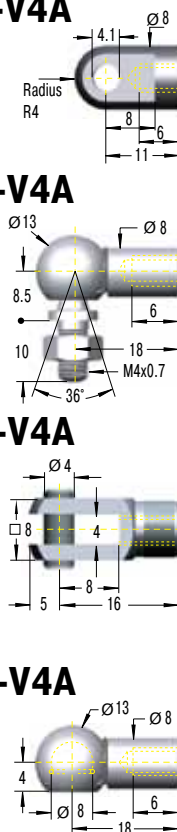
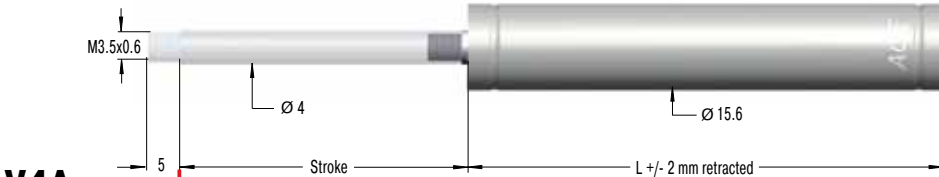

Dimensions

Type	Stroke mm	L retracted
GZ-15-20-V4A	20	87
GZ-15-40-V4A	40	107
GZ-15-50-V4A	50	117
GZ-15-60-V4A	60	127
GZ-15-80-V4A	80	147
GZ-15-100-V4A	100	167
GZ-15-120-V4A	120	187
GZ-15-150-V4A	150	217

Ordering Example

GZ-15-150-AC-150-V4A

Type (Pull Type) _____
 Body Ø (15 mm) _____
 Stroke (150 mm) _____
 Piston Rod End Fitting A3,5-V4A _____
 Body End Fitting C3,5-V4A _____
 Traction Force F₁ 150 N _____
 Indicated by K.-No. on delivery _____

The end fittings are interchangeable and must be positively secured by the customer to prevent unscrewing (i.e. Loctite).
 For mounting accessories see page 188.

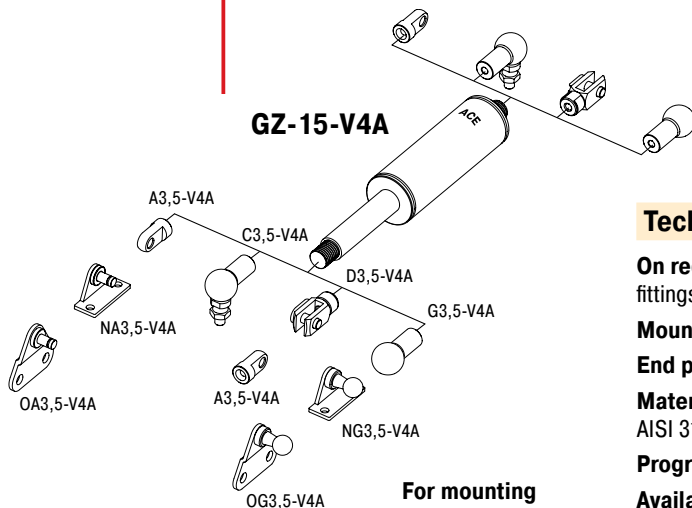

For mounting accessories see page 188.

Technical Data

- On request:** Special force curves, special lengths, alternative end fittings, rod shroud.
- Mounting:** In any position. Install mechanical stop in extended position.
- End position damping length:** Without damping
- Material:** Piston rod, body and end fittings: Material 1.4571/1.4404, AISI 316L/316Ti (V4A).
- Progression:** Approx. 23 %, F₂ max. 185 N
- Available traction force range F₁ at 20 °C:** 50 N to 150 N
- Note:** Lifetime approx. 2000 m

Issue 7.2014. Specifications subject to change

Traction (Pull) Forces 30 N to 300 N
(when Piston Rod Extended up to 333 N)

End Fitting

Standard Dimensions

End Fitting

B8

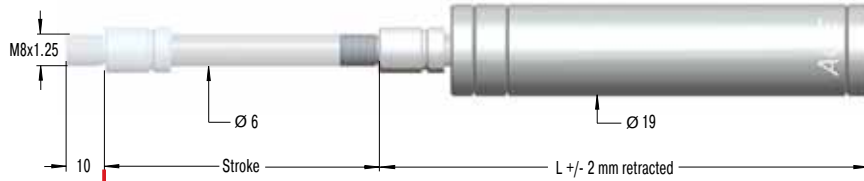

Stud Thread **B8**

A8-VA

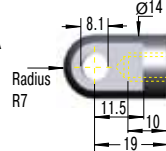

Dimensions

Type	Stroke mm	L retracted
GZ-19-30-VA	30	130
GZ-19-50-VA	50	150
GZ-19-100-VA	100	200
GZ-19-150-VA	150	250
GZ-19-200-VA	200	300
GZ-19-250-VA	250	350

Eye **A8-VA**
max. force 1560 N

C8-VA

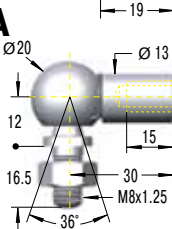

Angle Ball Joint **C8-VA**
max. force 1140 N

D8-VA

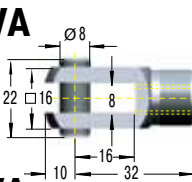

Clevis Fork **D8-VA**
max. force 1560 N

E8-VA

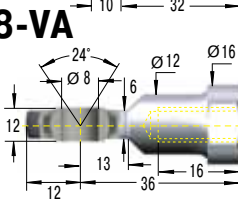

Swivel Eye **E8-VA**
max. force 1560 N

G8-VA

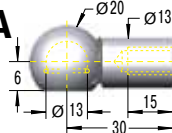

Ball Socket **G8-VA**
max. force 1140 N

Ordering Example

GZ-19-150-AC-150-VA

Type (Pull Type) _____
 Body Ø (19 mm) _____
 Stroke (150 mm) _____
 Piston Rod End Fitting A8-VA _____
 Body End Fitting C8-VA _____
 Traction Force F₁ 150 N _____
 Indicated by K.-No. on delivery _____

The end fittings are interchangeable and must be positively secured by the customer to prevent unscrewing (i.e. Loctite).
For mounting accessories see page 189.

Rod Shroud
W8-19-VA

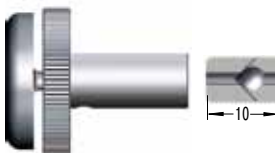
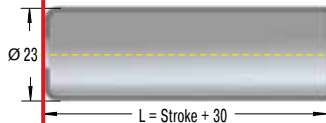

Adjuster Knob
DE-GAS-8
See page 149.

GZ-19-VA

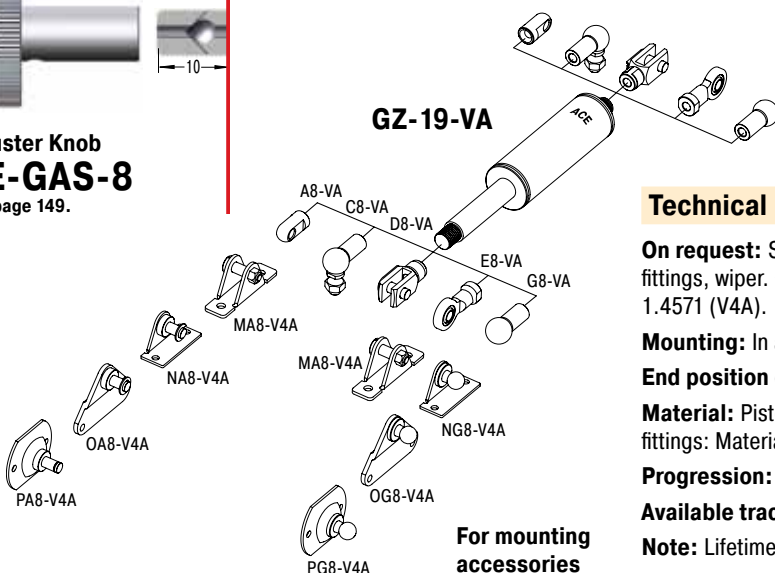

For mounting accessories see page 189.

Technical Data

On request: Special force curves, special lengths, alternative end fittings, wiper. Gas springs and accessories with material 1.4404/1.4571 (V4A).

Mounting: In any position. Install mechanical stop in extended position.

End position damping length: Without damping

Material: Piston rod: Material 1.4401, AISI 316L (V4A). Body and end fittings: Material 1.4301, AISI 304 (V2A).

Progression: Approx. 11%, F₂ max. 333 N

Available traction force range F₁ at 20 °C: 30 N to 300 N

Note: Lifetime approx. 2000 m

Traction (Pull) Forces 150 N to 1200 N
(when Piston Rod Extended up to 1460 N)

End Fitting

Standard Dimensions

End Fitting

B10

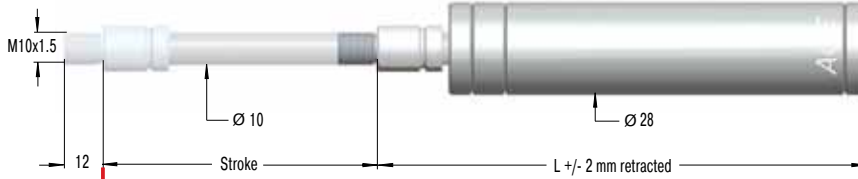

Stud Thread **B10**

A10-VA

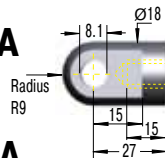

Dimensions

Type	Stroke mm	L retracted
GZ-28-50-VA	50	165
GZ-28-100-VA	100	215
GZ-28-150-VA	150	265
GZ-28-200-VA	200	315
GZ-28-250-VA	250	365
GZ-28-300-VA	300	415
GZ-28-350-VA	350	465
GZ-28-400-VA	400	515
GZ-28-450-VA	450	565
GZ-28-500-VA	500	615
GZ-28-550-VA	550	665
GZ-28-600-VA	600	715

Eye **A10-VA**
max. force 3800 N

C10-VA

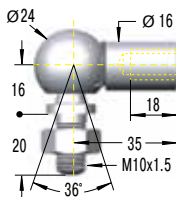

Angle Ball Joint
C10-VA
max. force 1750 N

D10-VA

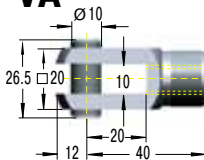

Clevis Fork **D10-VA**
max. force 3800 N

E10-VA

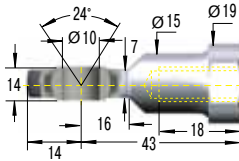

Swivel Eye **E10-VA**
max. force 3800 N

Ordering Example

GZ-28-150-EE-800-VA

Type (Pull Type) _____
 Body Ø (28 mm) _____
 Stroke (150 mm) _____
 Piston Rod End Fitting E10-VA _____
 Body End Fitting E10-VA _____
 Traction Force F₁ 800 N _____
 Indicated by K.-No. on delivery _____

The end fittings are interchangeable and must be positively secured by the customer to prevent unscrewing (i.e. Loctite).
For mounting accessories see page 189.

Rod Shroud
W10-28-VA

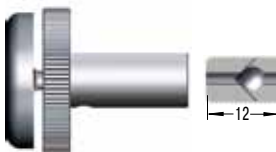
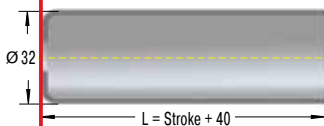

Adjuster Knob
DE-GAS-10
See page 149.

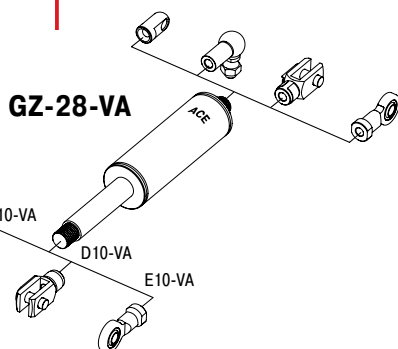

For mounting accessories see page 189.

Technical Data

On request: Special force curves, special lengths, alternative end fittings, wiper. Gas springs and accessories with material 1.4404/1.4571 (V4A).

Mounting: In any position. Install mechanical stop in extended position.

End position damping length: Without damping

Material: Piston rod, body and end fittings: Material 1.4301/1.4305, AISI 304/303 (V2A).

Progression: Approx. 22%, F₂ max. 1460 N

Available traction force range F₁ at 20 °C: 150 N to 1200 N

Note: Lifetime approx. 2000 m

Traction (Pull) Forces 400 N to 5000 N
(when Piston Rod Extended up to 7000 N)

End Fitting

Standard Dimensions

End Fitting

B14

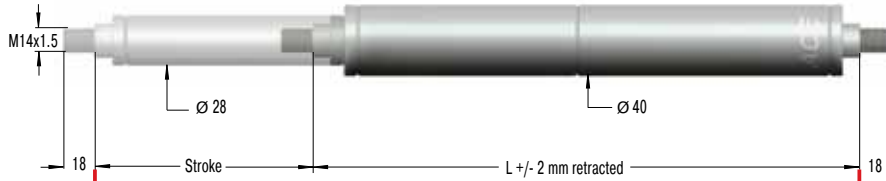

Stud Thread **B14**

A14-VA

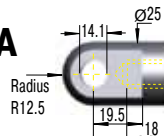

Dimensions

Type	Stroke mm	L retracted
GZ-40-100-VA	100	250
GZ-40-150-VA	150	325
GZ-40-200-VA	200	400
GZ-40-250-VA	250	475
GZ-40-300-VA	300	550
GZ-40-400-VA	400	700
GZ-40-500-VA	500	850
GZ-40-600-VA	600	1 000

Eye **A14-VA**
max. force 7000 N

C14-VA

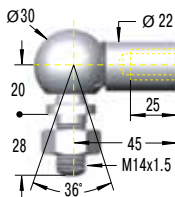

Angle Ball Joint
C14-VA
max. force 3200 N

D14-VA

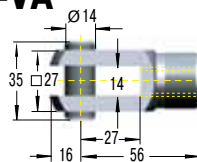

Clevis Fork **D14-VA**
max. force 7000 N

E14-VA

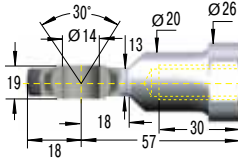

Swivel Eye **E14-VA**
max. force 7000 N

Ordering Example

GZ-40-150-EE-800-VA

Type (Pull Type) _____
 Body Ø (40 mm) _____
 Stroke (150 mm) _____
 Piston Rod End Fitting E14-VA _____
 Body End Fitting E14-VA _____
 Traction Force F₁ 800 N _____
 Indicated by K.-No. on delivery _____

The end fittings are interchangeable and must be positively secured by the customer to prevent unscrewing (i.e. Loctite).
For mounting accessories see page 190.

Rod Shroud
W14-40-VA

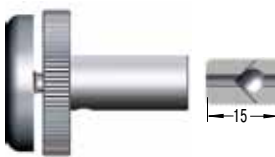
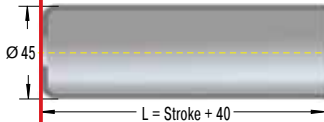

Adjuster Knob
DE-GAS-14
See page 149.

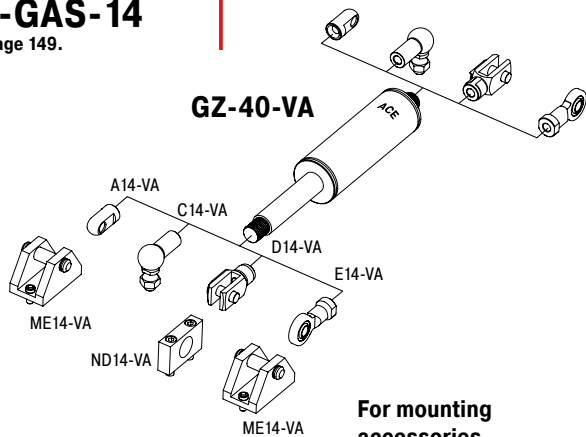

For mounting accessories see page 190.

Technical Data

On request: Increased traction force, special force curves, special lengths, alternative end fittings, wiper. Gas springs and accessories with material 1.4404/1.4571 (V4A).

Mounting: In any position. Install mechanical stop in extended position.

End position damping length: Without damping

Material: Piston rod, body and end fittings: Material 1.4301/1.4305, AISI 304/303 (V2A).

Progression: Approx. 40 %, F₂ max. 7000 N

Available traction force range F₁ at 20 °C: 400 N to 5000 N

Note: Lifetime approx. 2000 m

By taking advantage of the very extensive range of **ACE end fittings and mounting brackets** you can easily and simply install our gas springs and hydraulic dampers. You profit from the variety of **DIN Standard** end fittings such as swivel eyes, clevis forks, angle ball joints, inline ball joints, and complementary ball sockets. ACE also offers eye fittings made of wear-resistant steel to meet the higher specification requirements found in industrial applications. With over 30 different types available these mounting accessories provide an extensive range of combinations for optimum installations. With the ACE selection programme you can choose not only your ACE gas springs but also the ideal end fittings and mounting brackets for your individual application example.

The complete range of accessories are also available as individual components.

Interchangeable Combinable

"Just drill 4 holes – ACE does all the rest!"

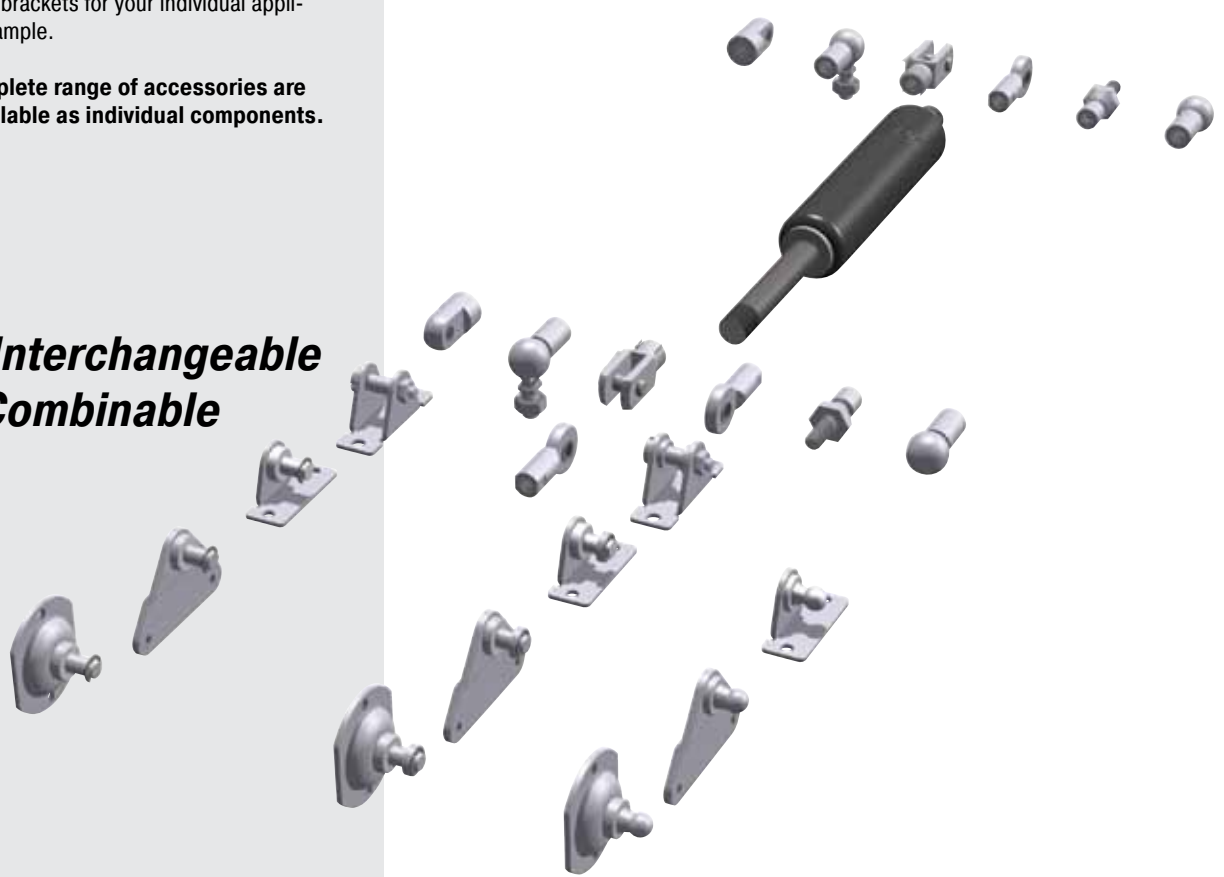

The wide range of mounting brackets available

Accessories M3.5x0.6

GS-8, GS-10, GS-12, GZ-15, HB-12

<p>A3,5 Eye</p> <p>1 max. force 370 N</p>	<p>C3,5 Angle Ball Joint DIN 71802</p> <p>1 max. force 370 N</p>	<p>D3,5 Clevis Fork DIN 71752</p> <p>1 max. force 370 N</p>	<p>E3,5 Swivel Eye DIN 648</p> <p>1 max. force 370 N</p>	<p>G3,5 Ball Socket DIN 71805</p> <p>1 max. force 370 N</p>	
<p>1 max. force 180 N</p>	<p>NA3,5</p>	<p>NG3,5</p>	<p>1 max. force 180 N</p>	<p>OA3,5</p>	<p>OG3,5</p>

Accessories M5x0.8

GS-15, HB-15

<p>A5 Eye</p> <p>1 max. force 800 N</p>	<p>C5 Angle Ball Joint DIN 71802</p> <p>1 max. force 500 N</p>	<p>D5 Clevis Fork DIN 71752</p> <p>1 max. force 800 N</p>	<p>E5 Swivel Eye DIN 648</p> <p>1 max. force 800 N</p>	<p>F5 Inline Ball Joint</p> <p>Attention! Must only be used with compression loads.</p> <p>1 max. force 500 N</p>	
<p>G5 Ball Socket DIN 71805</p> <p>1 max. force 500 N</p>	<p>1 max. force 500 N</p>	<p>MA5</p>	<p>1 max. force 400 N</p>	<p>NA5</p>	<p>NG5</p>
<p>1 max. force 180 N</p>	<p>OA5</p>	<p>OG5</p>	<p>1 max. force 500 N</p>	<p>PA5</p>	<p>PG5</p>

1 Attention! Max. static load in Newtons. Beware force increase during compression (progression) and observe max. force limit.

Accessories M8x1.25

GS-19, GS-22, GZ-19, HB-22, HB-28, HBS-28, DVC-32

A8 Eye 1 max. force 3000 N	C8 Angle Ball Joint DIN 71802 1 max. force 1200 N	D8 Clevis Fork DIN 71752 1 max. force 3000 N	E8 Swivel Eye DIN 648 1 max. force 3000 N	F8 Inline Ball Joint Attention! Must only be used with compression loads. 1 max. force 1200 N		
G8 Ball Socket DIN 71805 1 max. force 1200 N	MA8 ME8 1 max. force 1800 N		1 max. force 1000 N NA8 NE8 NG8 1 max. force 1200 N			
1 max. force 1200 N 	OA8 	OE8 	OG8 	1 max. force 1200 N 	PA8 	PE8 PG8

Accessories M10x1.5

GS-28, GZ-28, HBS-35

A10 Eye 1 max. force 10 000 N	C10 Angle Ball Joint DIN 71802 1 max. force 1800 N	D10 Clevis Fork DIN 71752 1 max. force 10 000 N	E10 Swivel Eye DIN 648 1 max. force 10 000 N	F10 Inline Ball Joint Attention! Must only be used with compression loads. 1 max. force 1800 N	
1 max. force 1800 N 	MA10 ME10 		1 max. force 1200 N 		
1 max. force 1200 N 	OE10 	1 max. force 1200 N 	PE10 		

¹ Attention! Max. static load in Newtons. Beware force increase during compression (progression) and observe max. force limit.

Accessories M14x1.5

GS-40, GST-40, GZ-40, HB-40, HBD-70

<p>A14 Eye</p> <p>1 max. force 10 000 N</p>	<p>C14 Angle Ball Joint DIN 71802</p> <p>1 max. force 3200 N</p>	<p>D14 Clevis Fork DIN 71752</p> <p>1 max. force 10 000 N</p>	<p>E14 Swivel Eye DIN 648</p> <p>1 max. force 10 000 N</p>	<p>F14 Inline Ball Joint Attention! Must only be used with compression loads.</p> <p>1 max. force 3200 N</p>
<p>1 max. force 10 000 N</p> <p>ME14</p>	<p>1 max. force 10 000 N</p> <p>ND14</p>			

¹ Attention! Max. static load in Newtons. Beware force increase during compression (progression) and observe max. force limit.

Accessories M24x2

GS-70, HB-70, HBS-70

<p>D24 Clevis Fork DIN 71752</p> <p>1 max. force 50 000 N</p>	<p>E24 Swivel Eye DIN 648</p> <p>1 max. force 50 000 N</p>
<p>1 max. force 50 000 N</p> <p>ME24</p>	<p>1 max. force 50 000 N</p> <p>ND24</p>

¹ Attention! Max. static load in Newtons. Beware force increase during compression (progression) and observe max. force limit.

Accessories M3.5x0.6

GS-8-V4A, GS-10-V4A, GS-12-V4A, GZ-15-V4A

<p>A3,5-V4A Eye</p> <p>1 max. force 370 N</p>	<p>C3,5-V4A Angle Ball Joint</p> <p>1 max. force 370 N</p>	<p>D3,5-V4A Clevis Fork</p> <p>1 max. force 370 N</p>	<p>G3,5-V4A Ball Socket</p> <p>1 max. force 370 N</p>
<p>1 max. force 180 N</p>	<p>NA3,5-V4A NG3,5-V4A</p>	<p>1 max. force 180 N</p>	<p>OA3,5-V4A OG3,5-V4A</p>

Accessories M5x0.8

GS-15-VA

<p>A5-VA Eye</p> <p>1 max. force 490 N</p>	<p>C5-VA Angle Ball Joint</p> <p>1 max. force 430 N</p>	<p>D5-VA Clevis Fork</p> <p>1 max. force 490 N</p>	<p>E5-VA Swivel Eye</p> <p>1 max. force 490 N</p>	<p>G5-VA Ball Socket</p> <p>1 max. force 430 N</p>
<p>1 max. force 500 N</p>	<p>MA5-V4A</p>	<p>1 max. force 400 N</p>	<p>NA5-V4A NG5-V4A</p>	
<p>1 max. force 180 N</p>	<p>OA5-V4A OG5-V4A</p>	<p>1 max. force 500 N</p>	<p>PA5-V4A PG5-V4A</p>	

¹ Attention! Max. static load in Newtons. Beware force increase during compression (progression) and observe max. force limit.

Accessories M8x1.25

GS-19-VA, GS-22-VA, GZ-19-VA

<p>A8-VA Eye</p> <p>1 max. force 1560 N</p>	<p>C8-VA Angle Ball Joint</p> <p>1 max. force 1140 N</p>	<p>D8-VA Clevis Fork</p> <p>1 max. force 1560 N</p>	<p>E8-VA Swivel Eye</p> <p>1 max. force 1560 N</p>	<p>G8-VA Ball Socket</p> <p>1 max. force 1140 N</p>
<p>1 max. force 1800 N</p> <p>1 max. force 1200 N</p>	<p>MA8-V4A</p>	<p>1 max. force 1000 N</p>	<p>NA8-V4A</p>	<p>NG8-V4A</p>
<p>O8-VA</p>	<p>OG8-V4A</p>	<p>1 max. force 1200 N</p>	<p>PA8-V4A</p>	<p>PG8-V4A</p>

Accessories M10x1.5

GS-28-VA, GZ-28-VA

<p>A10-VA Eye</p> <p>1 max. force 3800 N</p>	<p>C10-VA Angle Ball Joint</p> <p>1 max. force 1750 N</p>	<p>D10-VA Clevis Fork</p> <p>1 max. force 3800 N</p>	<p>E10-VA Swivel Eye</p> <p>1 max. force 3800 N</p>
<p>1 max. force 1800 N</p>	<p>MA10-V4A</p>		

1 Attention! Max. static load in Newtons. Beware force increase during compression (progression) and observe max. force limit.

Accessories M14x1.5

GS-40-VA, GZ-40-VA

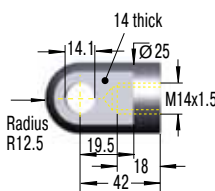
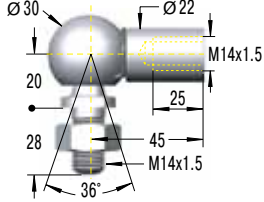
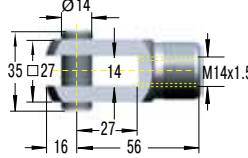
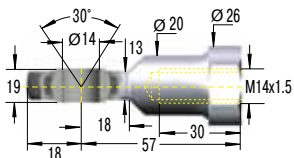
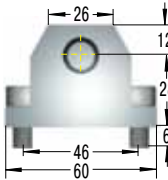
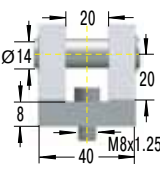
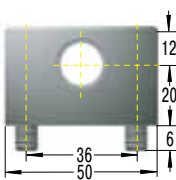
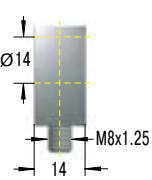
<p>A14-VA Eye</p>  <p>1 max. force 7000 N</p>	<p>C14-VA Angle Ball Joint</p>  <p>1 max. force 3200 N</p>	<p>D14-VA Clevis Fork</p>  <p>1 max. force 7000 N</p>	<p>E14-VA Swivel Eye</p>  <p>1 max. force 7000 N</p>
<p>1 max. force 10000 N</p> 	<p>ME14-VA</p> 	<p>1 max. force 10000 N</p> 	<p>ND14-VA</p> 

¹ Attention! Max. static load in Newtons. Beware force increase during compression (progression) and observe max. force limit.

Further Stainless Steel Gas Springs (Push Type), V4A

Type	Stroke mm	L extended	Dimensions see page
GS-15-20-V4A	20	74	168
GS-15-40-V4A	40	114	168
GS-15-50-V4A	50	134	168
GS-15-60-V4A	60	154	168
GS-15-80-V4A	80	194	168
GS-15-100-V4A	100	234	168
GS-15-120-V4A	120	274	168
GS-15-150-V4A	150	334	168
GS-19-50-V4A	50	164	169
GS-19-100-V4A	100	264	169
GS-19-150-V4A	150	364	169
GS-19-200-V4A	200	464	169
GS-19-250-V4A	250	564	169
GS-19-300-V4A	300	664	169
GS-22-50-V4A	50	164	170
GS-22-100-V4A	100	264	170
GS-22-150-V4A	150	364	170
GS-22-200-V4A	200	464	170
GS-22-250-V4A	250	564	170
GS-22-300-V4A	300	664	170
GS-22-350-V4A	350	764	170
GS-22-400-V4A	100	864	170
GS-22-450-V4A	450	964	170
GS-22-500-V4A	500	1 064	170
GS-22-550-V4A	550	1 164	170
GS-22-600-V4A	600	1 264	170
GS-22-650-V4A	650	1 364	170
GS-22-700-V4A	700	1 464	170
GS-28-100-V4A	100	262	171
GS-28-150-V4A	150	362	171
GS-28-200-V4A	200	462	171
GS-28-250-V4A	250	562	171
GS-28-300-V4A	300	662	171
GS-28-350-V4A	350	762	171
GS-28-400-V4A	400	862	171
GS-28-450-V4A	450	962	171
GS-28-500-V4A	500	1 062	171
GS-28-550-V4A	550	1 162	171
GS-28-600-V4A	600	1 262	171
GS-28-650-V4A	650	1 362	171
GS-40-100-V4A	100	317	172
GS-40-150-V4A	150	417	172
GS-40-200-V4A	200	517	172
GS-40-300-V4A	300	717	172
GS-40-400-V4A	400	917	172
GS-40-500-V4A	500	1 117	172
GS-40-600-V4A	600	1 317	172

Further Stainless Steel Gas Springs (Pull Type), V4A

Type	Stroke mm	L retracted	Dimensions see page
GZ-19-30-V4A	30	130	181
GZ-19-50-V4A	50	150	181
GZ-19-100-V4A	100	200	181
GZ-19-150-V4A	150	250	181
GZ-19-200-V4A	200	300	181
GZ-19-250-V4A	250	350	181
GZ-28-50-V4A	50	165	182
GZ-28-100-V4A	100	215	182
GZ-28-150-V4A	150	265	182
GZ-28-200-V4A	200	315	182
GZ-28-250-V4A	250	365	182
GZ-28-300-V4A	300	415	182
GZ-28-350-V4A	350	465	182
GZ-28-400-V4A	400	515	182
GZ-28-450-V4A	450	565	182
GZ-28-500-V4A	500	615	182
GZ-28-550-V4A	550	665	182
GZ-28-600-V4A	600	715	182
GZ-40-100-V4A	100	250	183
GZ-40-150-V4A	150	325	183
GZ-40-200-V4A	200	400	183
GZ-40-250-V4A	250	475	183
GZ-40-300-V4A	300	550	183
GZ-40-400-V4A	400	700	183
GZ-40-500-V4A	500	850	183
GZ-40-600-V4A	600	1 000	183

"Applicable under extreme environment conditions!"



Further Stainless Steel End Fittings, V4A

End Fittings	Dimensions see page
A5-V4A	188
C5-V4A	188
D5-V4A	188
E5-V4A	188
G5-V4A	188
A8-V4A	189
C8-V4A	189
D8-V4A	189
E8-V4A	189
G8-V4A	189
A10-V4A	189
C10-V4A	189
D10-V4A	189
E10-V4A	189
A14-V4A	190
C14-V4A	190
D14-V4A	190
E14-V4A	190

The innovative pneumatic clamping elements of the new **LOCKED series PL** were designed for a secure and reliable **process clamping** directly on the linear guide. They are adapted individually to the linear guide employed in each case and are available for almost all traditional rail sizes and manufacturers, for example, **INA, Bosch Rexroth, THK, NSK, Schneeberger, HiWin** and many more. Special profiles are also available on request. **The LOCKED series PL offers the highest clamping forces up to 10 000 N** with low system costs, in comparison with hydraulic and electrical solutions. The clamping elements are free to move when compressed air is applied and offer **optimal static clamping**, since failure of the pneumatics does not influence the clamping. By means of the steel pads used, 100 % clamping forces are also achieved where greased rails are necessary.

"All common rail profiles available!"



The safety clamping elements of the **LOCKED series SL** work using the same principle as the PL and PLK types and clamp directly on the open area of the guide rail. Through utilization of **special brake linings from low-wear sintered metal**, they offer an additional **emergency stop braking function**, as well as a clamping function. Stopping forces up to **10 000 N** are achieved by the well-proven spring steel sheet technology when the activation air is exhausted. In case of power failure, an instant emergency stop braking and/or **safety clamping** are implemented. The SL series is available for all usual rail profiles, and significantly increases the safety of your linear axis.

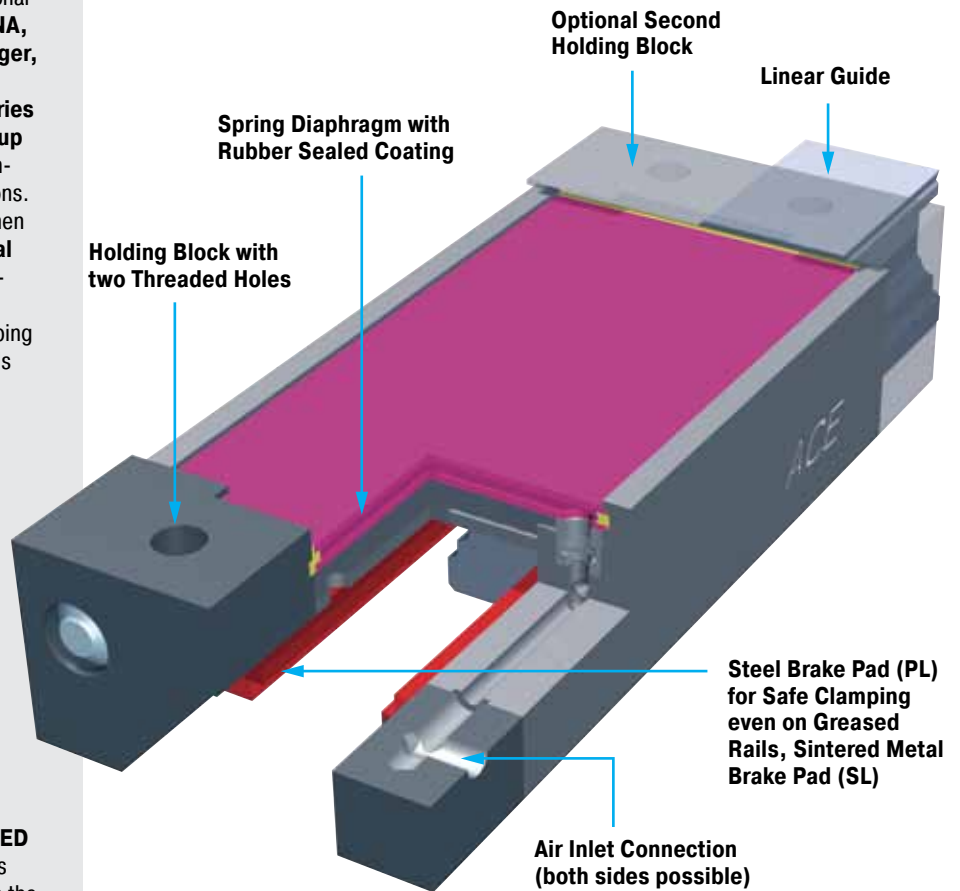

Rail sizes: 20 mm to 65 mm

Holding forces: 900 N to 10 000 N (6 bar type)

Clamping cycles/emergency use: 1 000 000/500. For higher values please consult ACE.

Material: Clamping body and milled parts: Tool steel. Spring steel plate: Spring steel. Brake pads: Steel (PL) or sintered metal (SL).

Mounting: In any position

Operating pressure: 4 bar or 6 bar (standard type)

Pneumatic medium: Dried, filtered air

Operating temperature range: 15 °C to 45 °C

On request: Wipers and special profiles.



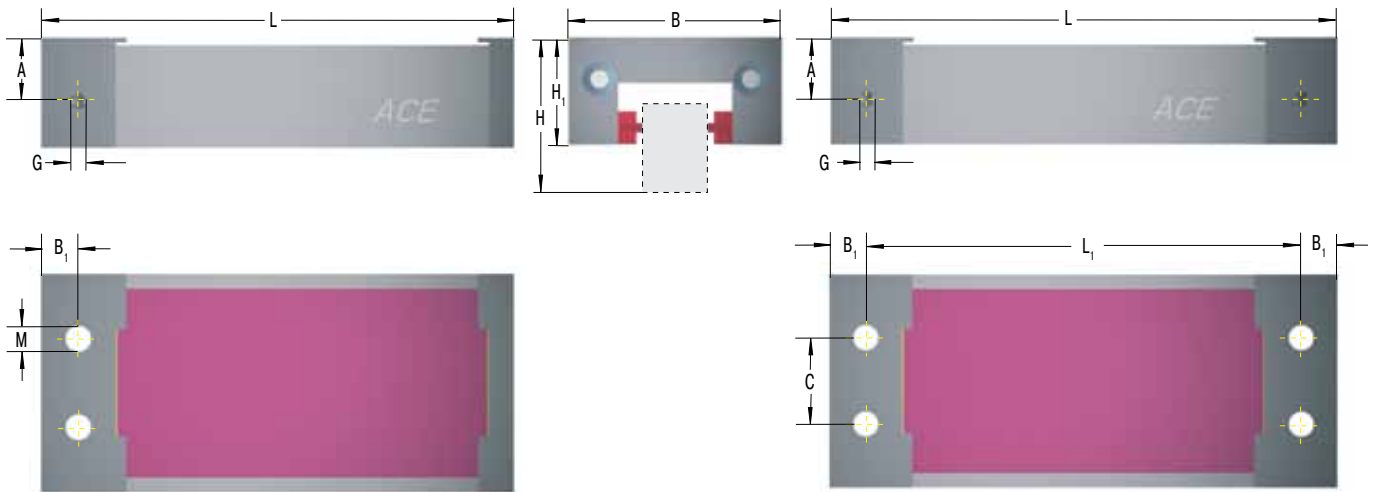

Ordering Example

Linear Process Clamping _____
 Rail Nominal Size 45 mm _____
 Number of Holding Blocks 2 _____
 6B = 6 bar Type _____
 4B = 6 bar Type _____
 Series Number assigned by ACE _____

PL45-2-6B-X

Complete Details Required when Ordering

Rail manufacturer, rail type, rail size
 Carriage type name
 Number of clamping cycles per hour
 Operating pressure: 4 bar or 6 bar
 Number of holding blocks

The calculation and selection of the correct clamping device should be made or approved by ACE.

Installation drawings of the different types are available on request.

Dimensions and Capacity Chart LOCKED-Series PL

Type	L	L ₁	B	Low Carriage			High Carriage			B ₁	C	G	M	1 Holding Force N		Weight kg
				H	H ₁	A	H	H ₁	A					Type		
														4 bar N	6 bar N	
PL20-1	97.5	-	43	30	19.5	13.5	-	-	-	6	12	M5	M5	540	900	0.32
PL25-1	117.5	-	47	36	25	15.5	40	29	19.5	6	16	M5	M6	780	1 200	0.5
PL30-1	126.5	-	59	42	29.5	17	45	32.5	20	10	18	M5	M8	1 100	1 800	0.9
PL35-1	156.5	-	69	48	35	22.5	55	42	29.5	10	22	G1/8	M10	1 800	2 800	1.26
PL45-1	176.5	-	80	60	42	26.5	70	52	36.5	10	28	G1/8	M10	2 400	4 000	2.3
PL45-2	191.5	171.2	80	60	42	26.5	70	52	36.5	10	28	G1/8	M10	2 400	4 000	2.3
PL55-1	202.5	-	98	70	49	28	80	59	38	12.5	34	G1/8	M10	3 600	6 000	3.9
PL55-2	221.5	196.2	98	70	49	28	80	59	38	12.5	34	G1/8	M10	3 600	6 000	4.1
PL65-1	259.5	-	120	90	64	38	100	74	48	15	44	G1/8	M12	6 000	10 000	5
PL65-2	281.5	251.5	120	90	64	38	100	74	48	15	44	G1/8	M12	6 000	10 000	5.2

¹ The holding forces as shown in the capacity chart were determined on dry rails for roller systems (STAR, INA). Different holding forces may occur for other rails.

Dimensions and Capacity Chart LOCKED-Series SL

Type	L	L ₁	B	Low Carriage			High Carriage			B ₁	C	G	M	1 Holding Force N		Weight kg
				H	H ₁	A	H	H ₁	A					Type		
														4 bar N	6 bar N	
SL20-1	97.5	-	43	30	19.5	13.5	-	-	-	6	12	M5	M5	540	900	0.32
SL25-1	117.5	-	47	36	25	15.5	40	29	19.5	6	16	M5	M6	780	1 200	0.5
SL30-1	126.5	-	59	42	29.5	17	45	32.5	20	10	18	M5	M8	1 100	1 800	0.9
SL35-1	156.5	-	69	48	35	22.5	55	42	29.5	10	22	G1/8	M10	1 800	2 800	1.26
SL45-1	176.5	-	80	60	42	26.5	70	52	36.5	10	28	G1/8	M10	2 400	4 000	2.3
SL45-2	191.5	171.2	80	60	42	26.5	70	52	36.5	10	28	G1/8	M10	2 400	4 000	2.3
SL55-1	202.5	-	98	70	49	28	80	59	38	12.5	34	G1/8	M10	3 600	6 000	3.9
SL55-2	221.5	196.2	98	70	49	28	80	59	38	12.5	34	G1/8	M10	3 600	6 000	3.9
SL65-1	259.5	-	120	90	64	38	100	74	48	15	44	G1/8	M12	6 000	10 000	5
SL65-2	281.5	251.2	120	90	64	38	100	74	48	15	44	G1/8	M12	6 000	10 000	5.2

¹ The holding forces as shown in the capacity chart were determined on dry rails for roller systems (STAR, INA). Different holding forces may occur for other rails.

As the compact version of the PL series, the **LOCKED series PLK** clamps directly on the respective linear guide by means of the patented spring steel sheet system. Clamping and stopping forces of up to 2100 N are achieved by small, **compact designs** when vented. The clamping is released by applying compressed air. Both a 4-bar activated system, e.g. for the automotive sector, and a 6-bar activated system are available. Also, the types of the LOCKED series PLK can be adapted to all traditional rail sizes (15 to 55) and profile sections of the individual providers.

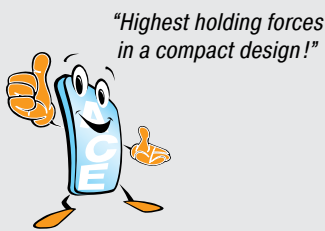

The safety clamping elements of the **LOCKED series SLK** also offer two functions combined into one clamping element through the use of special brake linings of low-wear sintered metal. As well as a purely clamping function, braking is possible with emergency stop directly on the rail, in the case of a possible power failure. On almost all commercially available linear guides, the highest stopping and braking forces are achieved with this the smallest, most compact construction design. Minimum reaction times result from the spring steel sheet technology employed.

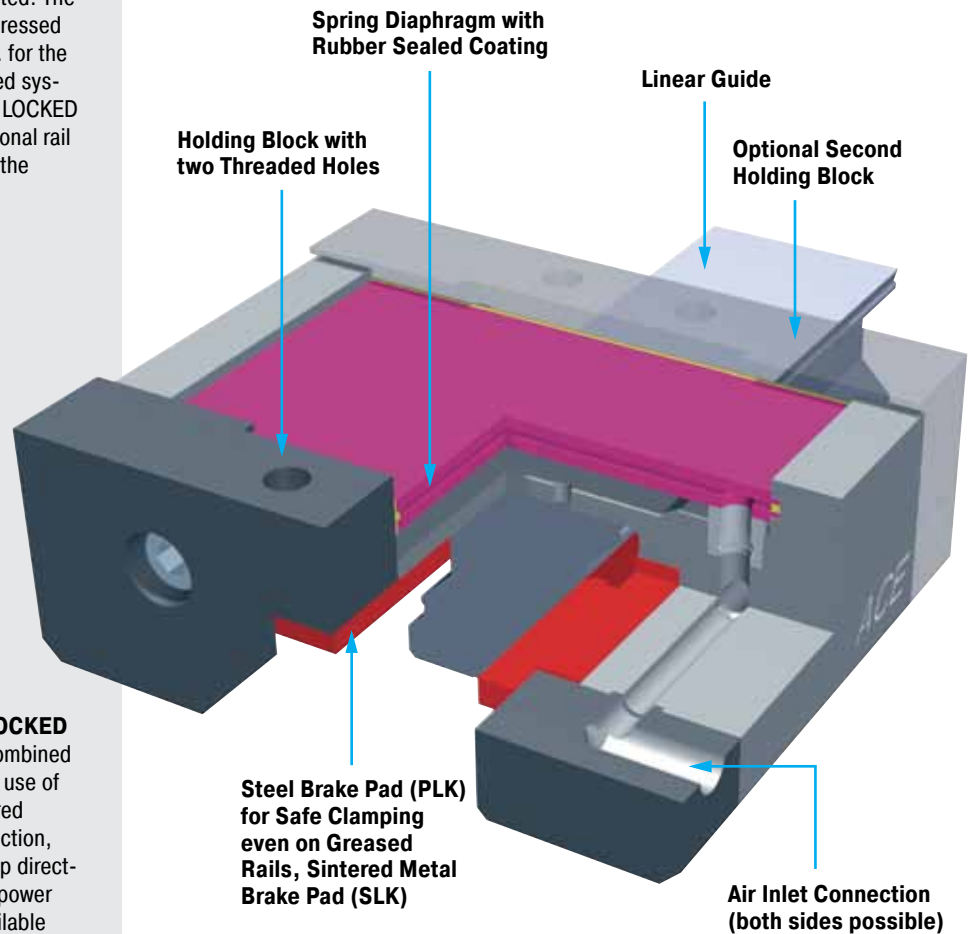

Rail sizes: 15 mm to 55 mm

Holding forces: 450 N to 2100 N (6 bar type)

Clamping cycles/emergency use: 1 000 000/500. For higher values please consult ACE.

Material: Clamping body and milled parts: Tool steel. Spring steel plate: Spring steel. Brake pads: Steel (PLK). Brake pads: Sintered metal (SLK).

Mounting: In any position

Operating pressure: 4 bar or 6 bar (standard type)

Pneumatic medium: Dried, filtered air

Operating temperature range: 15 °C to 45 °C

On request: Wipers and special profiles.



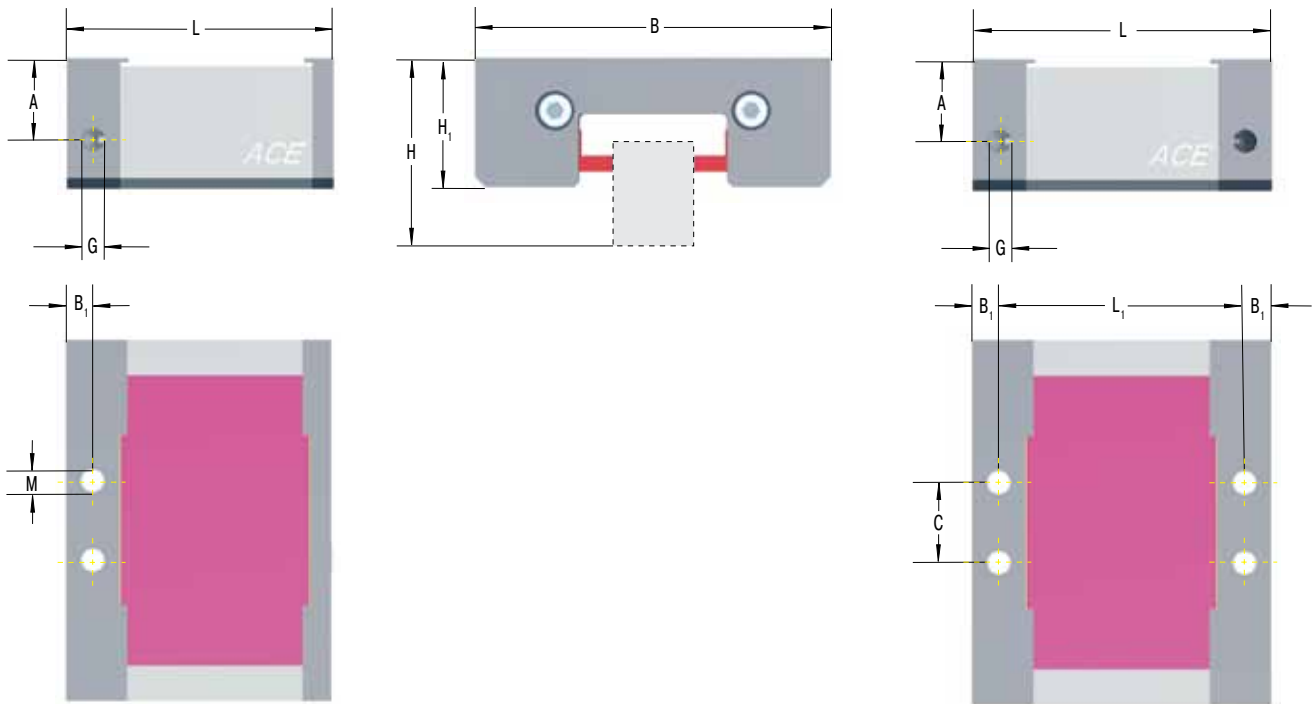

Ordering Example

Linear Process Clamping Compact _____
 Rail Nominal Size 55 mm _____
 Number of Holding Blocks 2 _____
 6B = 6 bar Type _____
 4B = 6 bar Type _____
 Series Number assigned by ACE _____

PLK55-2-6B-X

Complete Details Required when Ordering

- Rail manufacturer, rail type, rail size
- Carriage type name
- Number of clamping cycles per hour
- Operating pressure: 4 bar or 6 bar
- Number of holding blocks

The calculation and selection of the correct clamping device should be made or approved by ACE.

Installation drawings of the different types are available on request.

Dimensions and Capacity Chart LOCKED-Series PLK

Type	Low Carriage			High Carriage							1 Holding Force		Weight kg			
	L	L ₁	B	H	H ₁	A	H	H ₁	A	B ₁	C	G		M	Type	4 bar N
PLK15-1	55.5	-	45	24	18	14	-	-	14	5	12	M5	M5	300	450	0.5
PLK20-1	55.5	-	54	30	22	16	-	-	16	5	16	M5	M6	430	650	0.6
PLK25-1	55.5	-	75	36	25.5	16	40	29.5	16	5	16	M5	M6	530	800	0.7
PLK30-1	67	-	82	42	30	21	45	33	21	8.75	18	M5	M8	750	1 150	0.9
PLK35-1	67	-	96	48	35	21.2	55	42	21.2	8.75	22	G1/8	M10	820	1 250	1.27
PLK45-1	80	-	116	60	45	27.5	70	55	27.5	10	28	G1/8	M10	950	1 500	2
PLK45-2	92	72	116	60	45	27.5	70	55	27.5	10	28	G1/8	M10	950	1 500	2.2
PLK55-1	100	-	136	70	49	30.5	80	59	30.5	10	34	G1/8	M10	1 300	2 100	2.8
PLK55-2	112	92	136	70	49	30.5	80	59	30.5	10	34	G1/8	M10	1 300	2 100	3

¹ The holding forces as shown in the capacity chart were determined on dry rails for roller systems (STAR, INA). Different holding forces may occur for other rails.

Dimensions and Capacity Chart LOCKED-Series SLK

Type	Low Carriage			High Carriage							1 Holding Force		Weight kg			
	L	L ₁	B	H	H ₁	A	H	H ₁	A	B ₁	C	G		M	Type	4 bar N
SLK15-1	55.5	-	45	24	18	14	-	-	14	5	12	M5	M5	300	450	0.5
SLK20-1	55.5	-	54	30	22	16	-	-	16	5	16	M5	M6	430	650	0.6
SLK25-1	55.5	-	75	36	25.5	16	40	29.5	16	5	16	M5	M6	530	800	0.7
SLK30-1	67	-	82	42	30	21	45	33	21	8.75	18	M5	M8	750	1 150	0.9
SLK35-1	67	-	96	48	35	21.2	55	42	21.2	8.75	22	G1/8	M10	820	1 250	1.27
SLK45-1	80	-	116	60	45	27.5	70	55	27.5	10	28	G1/8	M10	950	1 500	2
SLK45-2	92	72	116	60	45	27.5	70	55	27.5	10	28	G1/8	M10	950	1 500	2.2
SLK55-1	100	-	136	70	49	30.5	80	59	30.5	10	34	G1/8	M10	1 300	2 100	2.8
SLK55-2	112	92	136	70	49	30.5	80	59	30.5	10	34	G1/8	M10	1 300	2 100	3

¹ The holding forces as shown in the capacity chart were determined on dry rails for roller systems (STAR, INA). Different holding forces may occur for other rails.

The innovative pneumatic clamping element of the new **LOCKED-LZ series** was especially designed for the safe and reliable clamping of vertical axes (Z-axes). The movement of the gravity-loaded axis is eliminated due to the tried and proven wedge principle. In the process the chocks are bilaterally pushed against the plane-parallel surfaces of the guide rail in case of a pressure drop. This system achieves holding forces of up to 1500 N. Initially the LOCKED-LZ was developed for a Bosch Rexroth rail of 15 mm. In future the clamping element will also be available for the rail sizes 20 mm and 25 mm and will possess a trade association permit.



"Highest clamping forces on the 15 mm rail!"

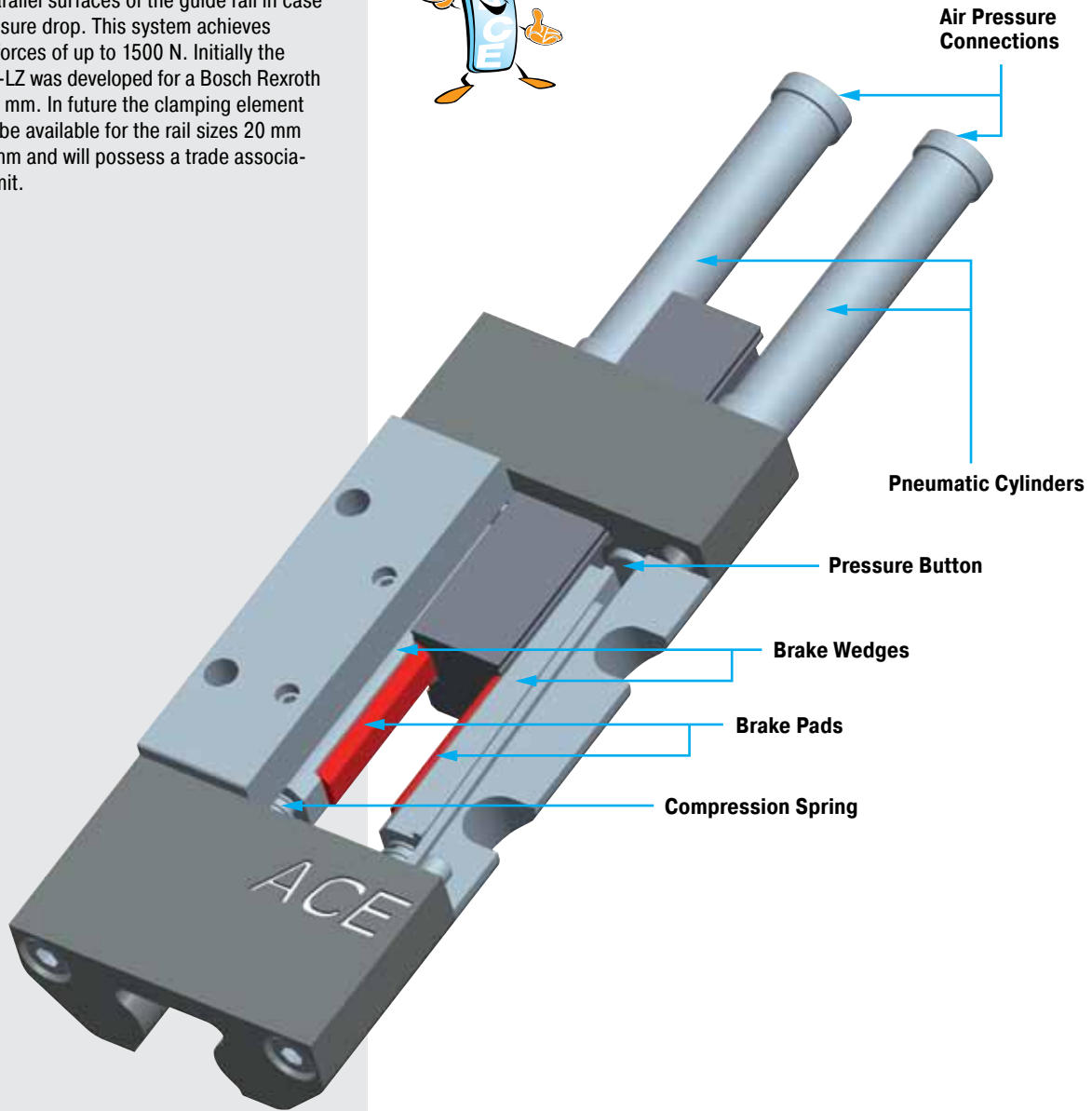

- Rail sizes:** Bosch Rexroth 15 mm
- Holding forces:** Up to 1500 N
- Clamping cycles/emergency use:** 1 000 000/2000
- Material:** Clamping body and milled parts: Tool steel.
- Mounting:** In vertical position
- Effective direction:** Z-axes toward gravity
- Operating pressure:** 4 bar to 6 bar
- Pneumatic medium:** Dried, filtered air
- Operating temperature range:** 0 °C to 60 °C



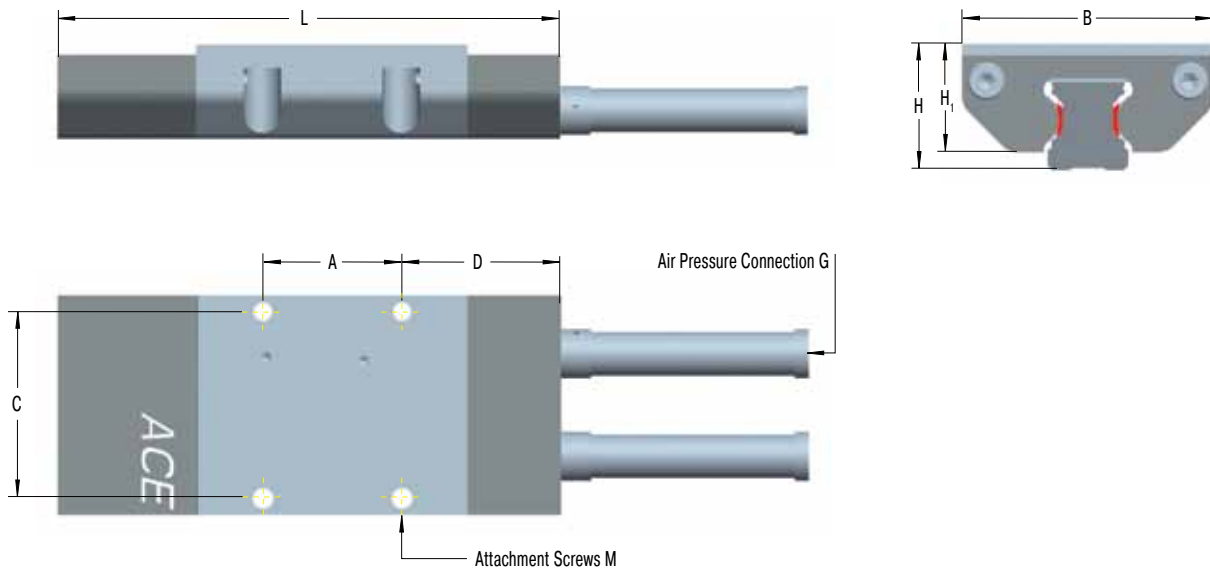

Ordering Example

Process Clamping Z-Axis _____
 Rail Nominal Size 15 mm _____
 Series Number assigned by ACE _____

LZ-P15-X

The calculation and selection of the correct clamping device should be made or approved by ACE.

Installation drawings of the different types are available on request.

Dimensions and Capacity Chart

Type	L	B	H	H ₁	A	C	D	G	M	Holding Force N	Weight kg
LZ-P15-X	108.5	47	24	20	30	40	34	M3	M4	1 500	0.4

The innovative **LOCKED series P** offers pneumatic rod clamping in both directions of motion, for rod diameters from 16 mm up to 40 mm. The forces achieved with hydraulic clamping are matched and often exceeded with **stopping forces up to 27 000 N**. LOCKED-P is an optimal safety clamping, because failure of the pneumatics means instant clamping of the system. ACE LOCKED is a much more cost effective solution to hydraulic systems. The ACE LOCKED-P clamping elements are advantageous due to their compact construction, and thus enable short rod lengths. By the use of a **modular system**, several segments can be stacked, so that the necessary clamping force can be sized individually for every application. In case of the versions for **ISO pneumatic cylinders**, the base plate is coordinated dimensionally to the flange measurements of the standard cylinders, in accordance with ISO 15552.



"On request also useable as torque lock!"

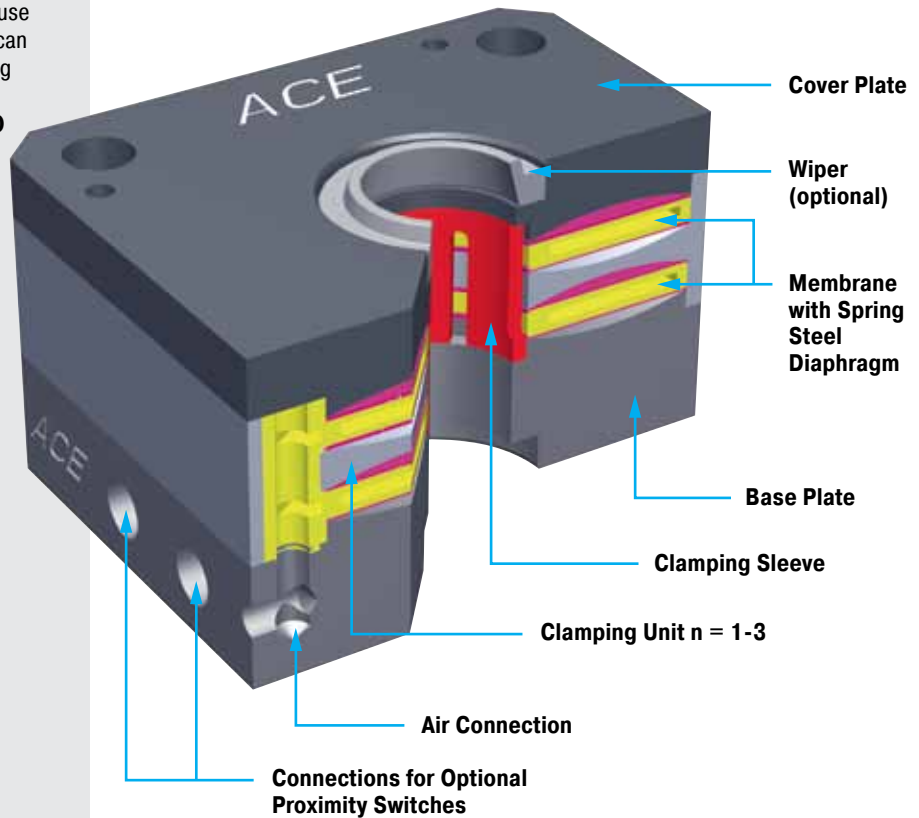

Rod diameter: 16 mm to 40 mm (hardened piston rod recommended)

Holding forces: Up to 27 000 N

Clamping cycles: 1 000 000. For higher values please consult ACE.

Material: Clamping body and milled parts: Tool steel. Spring steel plate: Spring steel. Clamping sleeve: Alum-bronze.

Operating pressure: 4 bar (automotive) or 6 bar

Pneumatic medium: Dried, filtered air

Operating temperature range: 10 °C to 45 °C



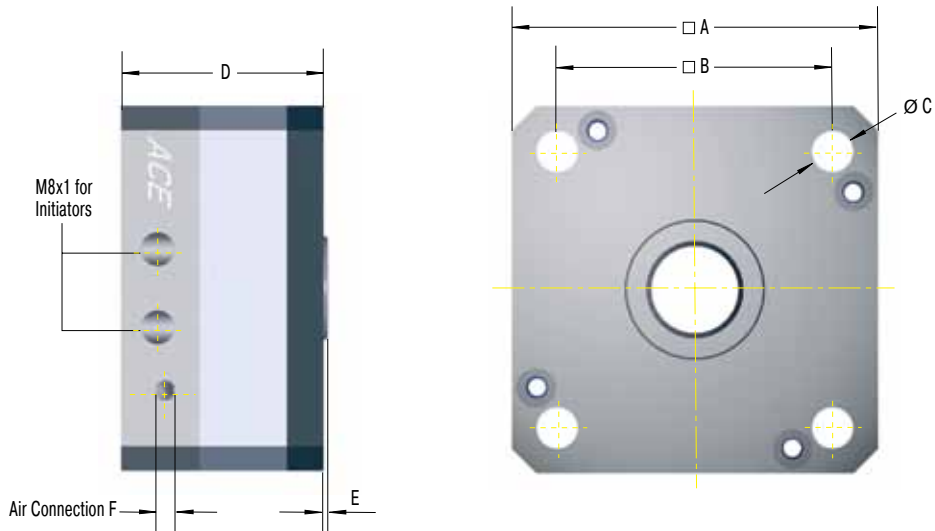

Ordering Example

Rod Clamping Standard Model _____
 Cylinder Nominal Diameter 80 mm _____
 Rod Diameter 25 mm _____
 Number of Clamping Units 3 _____
 6B = 6 bar Type _____
 4B = 4 bar Type _____

PN80-25-3-4B

Standard rod sizes are listed in the capacity charts below. Special diameters are also available on request.

The calculation and selection of the correct clamping device should be made or approved by ACE.

Installation drawings of the different types are available on request.

Dimensions and Capacity Chart

Type	A	B	C	D	E	F	1 Holding Force N		1 Holding Torque Nm		Weight kg
							Type		Type		
							4 bar	6 bar	4 bar	6 bar	
PN63-20-1	75	56.5	8.5	41.5	2.1	M5	1 400	2 000	15	20	0.7
PN63-20-2	75	56.5	8.5	59.5	2.1	M5	2 520	3 600	25	35	1.13
PN63-20-3	75	56.5	8.5	77.5	2.1	M5	3 780	5 400	35	50	1.56
PN80-25-1	96	72	10.5	43.5	2.14	G1/8	2 100	3 000	25	35	1.3
PN80-25-2	96	72	10.5	63.5	2.14	G1/8	3 780	5 400	40	60	2.2
PN80-25-3	96	72	10.5	83.5	2.14	G1/8	5 670	8 100	65	95	3.1
PN125-40-1	145	110	13	51.6	3	G1/8	7 000	10 000	140	200	3.65
PN125-40-2	145	110	13	75.2	3	G1/8	12 600	18 000	250	360	5.85
PN125-40-3	145	110	13	98.8	3	G1/8	18 900	27 000	375	540	8.05

¹ The listed holding forces are reached under optimum conditions. We recommend a safety factor of > 10 %. Please note that surface, material and cleanliness of the rod as well as wear and tear and the use of rod wipers lead to different holding forces. Test the clamping needed for series production or safety applications in its specific application environment and measure the actual values.

The **LOCKED series PRK** is a pneumatic rod clamping in a compact construction design. The small installation height enables utilization in the case of limited construction space. Installation heights of 28 to 34 mm offer clamping forces up to 5000 N. The clamping forces are applied in both tension and compression. The clamping is implemented by a membrane/spring steel sheet system, and is released through the application of compressed air, either 4 bar or alternatively 6 bar. Due to the operational method, the PRK series is optimally suited for use as a static clamping system, because failure of the pneumatics means instant clamping.



*"Rod clamping
in a compact design!"*

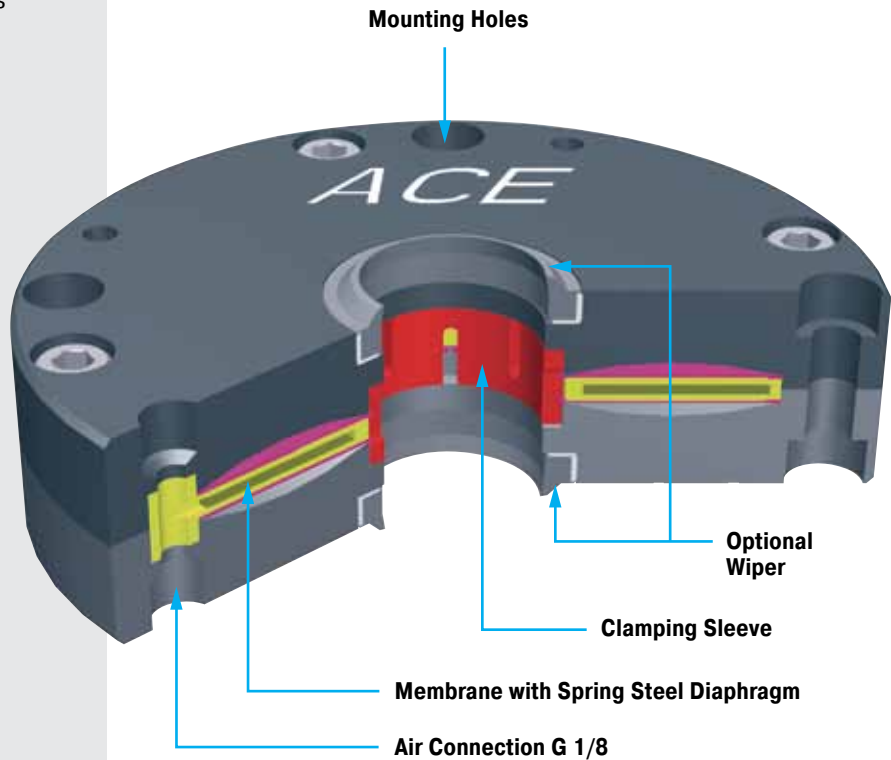

Rod diameter: 20 mm to 40 mm (special diameters on request; hardened piston rod recommended).

Holding forces: Up to 5000 N

Clamping cycles: 1 000 000. For higher values please consult ACE.

Material: Clamping body and milled parts: Tool steel. Spring steel plate: Spring steel. Clamping sleeve: Alum-bronze.

Operating pressure: 4 bar (automotive) or 6 bar

Pneumatic medium: Dried, filtered air

Operating temperature range: 10 °C to 45 °C



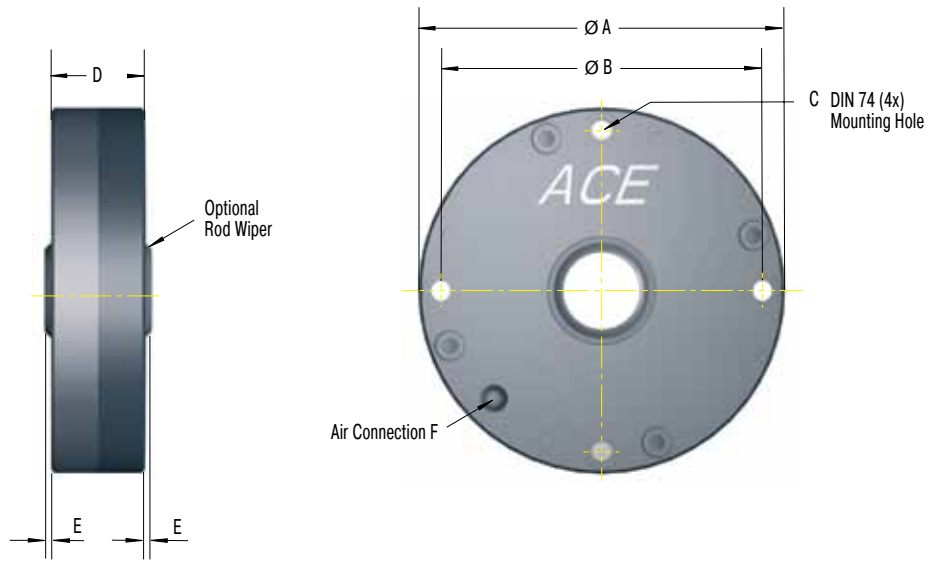

Ordering Example

Rod Clamping Compact _____
 Cylinder Nominal Diameter 80 mm _____
 Rod Diameter 25 mm _____
 6B = 6 bar Type _____
 4B = 4 bar Type _____

PRK80-25-6B

Standard rod sizes are listed in the capacity charts below.
 Special diameters are also available on request.

The calculation and selection of the correct clamping device
 should be made or approved by ACE.

Installation drawings of the different types are available on
 request.

Dimensions and Capacity Chart

Type	A	B	C	D	E	F	¹ Holding Force N		¹ Holding Torque Nm		Weight kg
							Type		Type		
							4 bar	6 bar	4 bar	6 bar	
PRK63-20	92	80	M5	28	2.1	G1/8	700	1 000	7	10	1.15
PRK80-25	118	104	M6	29	2.14	G1/8	1 050	1 500	12	17	2.1
PRK125-40	168	152	M6	29	3	G1/8	3 500	5 000	70	100	4.9

¹ The listed holding forces are reached under optimum conditions. We recommend a safety factor of > 10%. Please note that surface, material and cleanliness of the rod as well as wear and tear and the use of rod wipers lead to different holding forces. Test the clamping needed for series production or safety applications in its specific application environment and measure the actual values.

The innovative pneumatic clamping elements of the **LOCKED Series R** from ACE offer the highest brake torques for the clamping of rotary motions directly on the shaft. They are available in standard sizes for shaft diameters from 50 to 340 mm. Through the membrane/spring steel sheet system, a pressure decrease results in **instant clamping**. Through the utilization of pneumatic quick-acting valves, extremely short reaction times can be realized. The costs are low in comparison with hydraulic clamping systems. In spite of compact and easy to install construction method, the values achieved by hydraulic clamping are matched or even exceeded. In addition, custom-built designs for YRT bearings, as well as active clamping elements, are available. ACE recommends the utilization of the optional shaft flanges as wear protection.

NEW

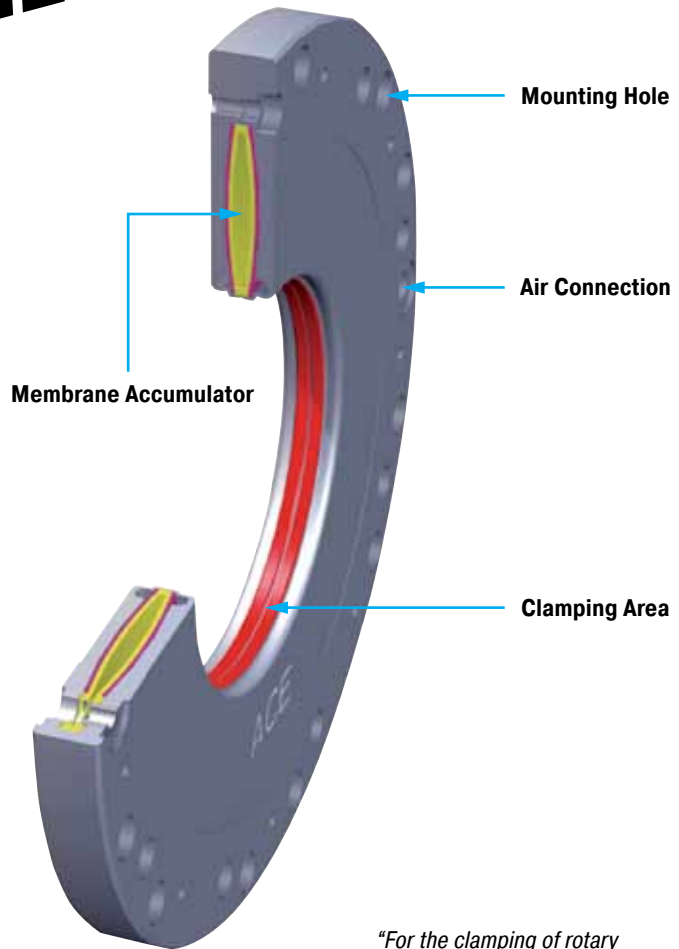

"For the clamping of rotary motions too!"



Clamping cycles: 1 000 000. For higher values please consult ACE.

Material: Clamping body: Hardened fine-grain structural steel, inner bore ground. Optionally fitting shaft flanges: C45 standard or steel coated.

Operating pressure: 4 bar or 6 bar (standard type)

Pneumatic medium: Dried, filtered air

Operating temperature range: 10 °C to 45 °C

Holding torques: Up to 4680 Nm

Shaft diameter: 50 mm to 340 mm (up to 460 mm for the YRT model)



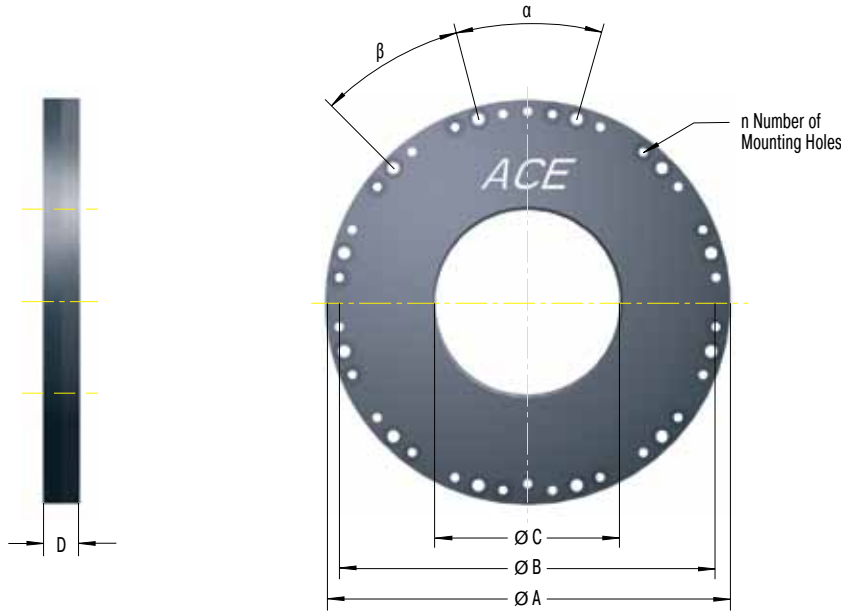

Ordering Example

Rotational Clamping _____
 Shaft Nominal Diameter 80 mm _____
 Z = Increased Force with Additional Air _____
 6B = 6 bar Type _____
 4B = 4 bar Type _____

R80-Z-6B

Complete Details Required when Ordering

Operating pressure: 4 bar or 6 bar
 Option: With additional air

The calculation and selection of the correct clamping device should be made or approved by ACE.

Installation drawings of the different types are available on request.

Dimensions and Capacity Chart

Type	C opened	Shaft Diameter	A	B	D	n	α	β	Holding Torque Nm		Weight kg
									4 bar	6 bar	
R50	50+0.03/+0.05	50-0.01/-0.025	145	134	15	8	45	45	42	60	1.7
R60	60+0.03/+0.05	60-0.01/-0.025	155	144	15	8	45	45	59	84	1.9
R70	70+0.03/+0.05	70-0.01/-0.025	165	154	15	12	30	30	80	114	2.1
R80	80+0.03/+0.05	80-0.01/-0.025	175	164	15	12	30	30	105	150	2.3
R90	90+0.03/+0.05	90-0.01/-0.025	185	174	15	12	30	30	132	189	2.5
R100	100+0.04/+0.06	100-0.01/-0.025	228	210	16	12	40	20	168	240	4.1
R120	120+0.04/+0.06	120-0.01/-0.025	248	230	16	12	40	20	235	336	4.6
R140	140+0.04/+0.06	140-0.01/-0.025	268	250	16	12	40	20	319	456	5.1
R160	160+0.04/+0.06	160-0.01/-0.025	288	270	16	12	40	20	420	600	5.6
R180	180+0.04/+0.06	180-0.01/-0.025	308	290	20	16	30	15	525	750	7.7
R200	200+0.05/+0.07	200-0.01/-0.03	328	310	20	16	30	15	651	930	8.3
R220	220+0.05/+0.07	220-0.01/-0.03	348	330	20	16	30	15	777	1 110	8.9
R240	240+0.05/+0.07	240-0.01/-0.03	368	350	20	24	20	10	945	1 350	9.5
R260	260+0.05/+0.07	260-0.01/-0.03	388	370	22	24	20	10	1 092	1 560	11.2
R280	280+0.05/+0.07	280-0.01/-0.03	408	390	22	24	20	10	1 260	1 800	11.9
R300	300+0.05/+0.07	300-0.01/-0.03	428	410	22	24	20	10	1 470	2 100	12.6
R320	320+0.05/+0.07	320-0.01/-0.03	448	430	22	24	20	10	1 638	2 340	13.1
R340	340+0.05/+0.07	340-0.01/-0.03	468	450	22	24	20	10	1 806	2 580	14
Type Z											
R50-Z	50+0.03/+0.05	50-0.01/-0.025	145	134	15	8	45	45	76	108	1.7
R60-Z	60+0.03/+0.05	60-0.01/-0.025	155	144	15	8	45	45	107	153	1.9
R70-Z	70+0.03/+0.05	70-0.01/-0.025	165	154	15	12	30	30	147	210	2.1
R80-Z	80+0.03/+0.05	80-0.01/-0.025	175	164	15	12	30	30	189	270	2.3
R90-Z	90+0.03/+0.05	90-0.01/-0.025	185	174	15	12	30	30	239	342	2.5
R100-Z	100+0.04/+0.06	100-0.01/-0.025	228	210	16	12	40	20	294	420	4.1
R120-Z	120+0.04/+0.06	120-0.01/-0.025	248	230	16	12	40	20	420	600	4.6
R140-Z	140+0.04/+0.06	140-0.01/-0.025	268	250	16	12	40	20	588	840	5.1
R160-Z	160+0.04/+0.06	160-0.01/-0.025	288	270	16	12	40	20	756	1 080	5.6
R180-Z	180+0.04/+0.06	180-0.01/-0.025	308	290	20	16	30	15	966	1 380	7.7
R200-Z	200+0.05/+0.07	200-0.01/-0.03	328	310	20	16	30	15	1 176	1 680	8.3
R220-Z	220+0.05/+0.07	220-0.01/-0.03	348	330	20	16	30	15	1 428	2 040	8.9
R240-Z	240+0.05/+0.07	240-0.01/-0.03	368	350	20	24	20	10	1 680	2 400	8.9
R260-Z	260+0.05/+0.07	260-0.01/-0.03	388	370	22	24	20	10	1 974	2 820	11.2
R280-Z	280+0.05/+0.07	280-0.01/-0.03	408	390	22	24	20	10	2 268	3 240	11.9
R300-Z	300+0.05/+0.07	300-0.01/-0.03	428	410	22	24	20	10	2 604	3 720	12.6
R320-Z	320+0.05/+0.07	320-0.01/-0.03	448	430	22	24	20	10	2 940	4 200	13.1
R340-Z	340+0.05/+0.07	340-0.01/-0.03	468	450	22	24	20	10	3 276	4 680	14

Functional Principle LOCKED-PL/PLK/SL/SLK

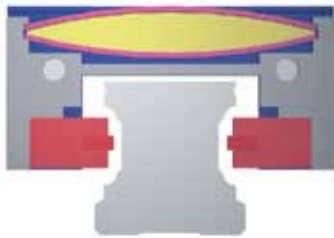

Example: Bosch Rexroth installation

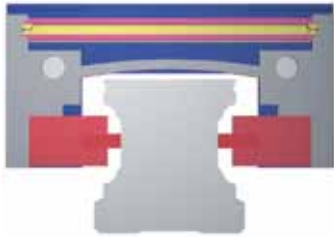

Released:

The chamber filled with compressed air between the spring steel plates relaxes and thus releases the clamping/brake pads from the rail. The clamping element is now free to move.

Engaged:

The clamping force of the mechanically pre-stressed spring steel plates is transferred to the clamping/brake pads as holding force. The clamping element is clamped on the guide rail.

Slot Dimensions between Braking and Clamping Linings and Linear Guide Rail

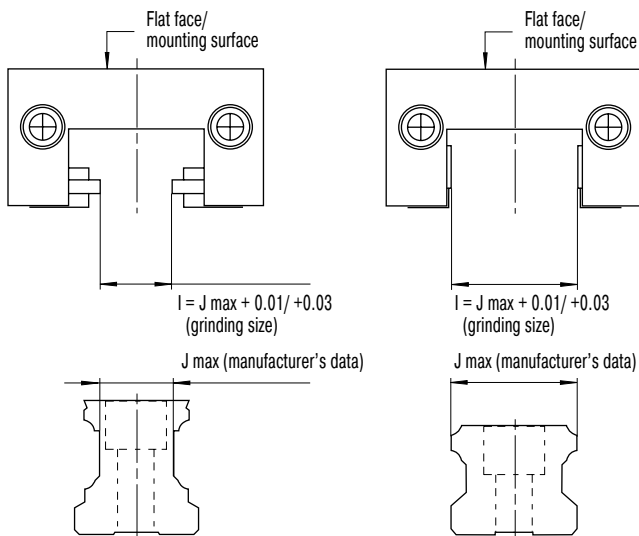

The internal dimension "I" between the linings of every LOCKED rail clamping is ground to an exact value. This is always 0.01 to 0.03 mm greater than the upper limit J max. of the respective linear guide rail (see drawing), resulting from the manufacturer's directives. The maximum holding force results at J max. and, in the most unfavorable case, holding force losses up to 30% can occur (see table).

Air Gap Lining/Linear Guide Rail mm	Loss in Holding Force %
0.01	5
0.03	10
0.05	20
0.07	30

Clamping



Position Clamping

The types of the LOCKED series PL and PLK are designed for clamping directly on the linear guide. The clamping linings are produced from tool steel and offer 100% clamping force, even in the case of lubricated rails.

Braking

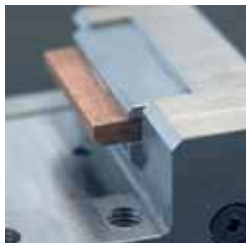

Position Clamping and Emergency Stop Braking

With the typical SL, SLK, low-wear sinter graphite linings are employed. These enable both a position clamping, as well as emergency stop braking on the linear guide. In case of lubricated rails, a stopping force of 60% of the nominal stopping force should be considered.

Functional Principle LOCKED-PN/PRK

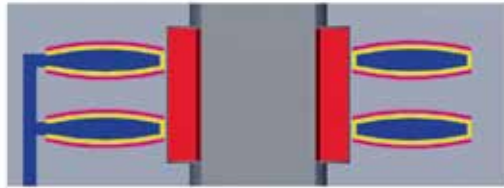
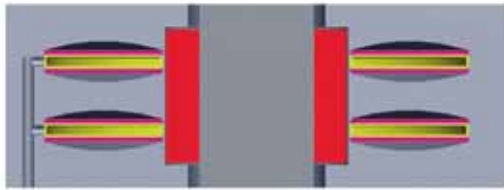

Engaged:

The clamping force of the mechanically pre-stressed spring steel plates system is transferred as a holding force into the clamping sleeve. The rod or shaft is engaged.

Released:

The membrane filled with compressed air relaxes the spring steel plate system and releases the clamping sleeve.

Intelligent Component System Solution for LOCKED-PN



By connecting up to three clamping units between the base and deck plates, it is possible to easily increase the clamping force.

Notes on Safety

Design-related, the addition of the individual component tolerances leads to an elastic axial tolerance allowance. This axial tolerance allowance can be up to 500 µm in the clamped status, according to implementation!

The axis/shaft/rod must be machined with at least h9-fit (or better) above h5. Deviations from the prescribed tolerance can lead to reduction of the stopping force, or functional failure.

Functional Principle LOCKED-R



Released:

The membrane filled with compressed air relaxes the spring steel plate system and releases the clamping ring. The shaft is free to move.

Engaged:

The clamping force of the membrane/spring steel plates systems is transferred to the holding force of the clamping ring. The shaft is clamped.

Engaged with additional air:

By filling the outer membrane chamber with additional compressed air (4 or 6 bar), there is the possibility to increase the clamping force. The clamping element is engaged in this condition.

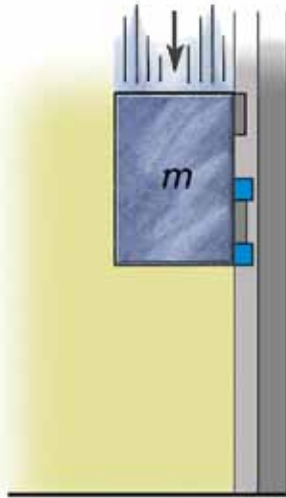

Secure rail clamping

ACE clamping elements secure machines in the tyre industry. The goods accumulator/compensator of a material dispenser carries meandering, coiled, highly tear resistant material strips, which are fed at high speed to a tyre-manufacturing machine. To prevent damaging the machine, innovative type **SLK25-1-6B** clamping elements are employed.



Secure material accumulator

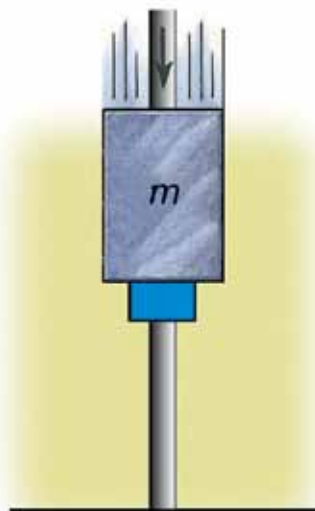

Secure rod clamping

Pneumatic rod clamping allows hydraulic presses to be used for any application.

With the help of hydraulic presses, cut ceramic parts are manufactured during the week. So that the rods of the upper and lower stamping plate do not sag when the press is at a standstill over the weekend or during holidays and therefore have to be setup again on the next working day, **PN80-25-2-6B** type rod clamps are used.



With the kind permission of KOMAGE Gellner Maschinenfabrik KG
Secured Presses



United States

Location	City	Distributor	Telephone		Internet
Alabama	Montgomery	Air Hydro Power	(866) 270-7041	(334) 215-2697	www.airhydropower.com
Arizona	Tempe	Barkley Playman Co. Inc.	(800) 525-8592	(480) 968-2594	www.barkleyfluidpower.com
Arkansas	Fort Smith	Franklin Electrofluid Co.	(479) 646-7448	(479) 646-2263	www.frankelectro.com
California	Costa Mesa Sant Jose	Clayton Controls Co. Nor-Cal Controls Inc.	(714) 556-9446 (408) 435-0400	(714) 241-9203 (408) 435-0410	www.claycon.com www.norcal4air.com
Colorado	Englewood	Advanced Air Products Co.	(801) 207-2400	(801) 207-2401	www.aapautomation.com
Connecticut	Bloomfield	Pearse- Bertram Company	(860) 242-7777	(860) 242-2673	www.pearse-bertram.com
Florida	Tampa	Gulf Controls Corp.	(813) 884-0471	(800) 282-9120	www.gulfcontrols.com
Georgia	Stone Mountain	TSI Solutions	(770) 879-3500	(770) 879-3511	www.4tsi.com
Illinois	Elk Grove Village	Fluid Power Engineering Co.	(847) 364-7455	(847) 364-7797	www.fpeinc.com
Indiana	Fort Wayne Indianapolis South Bend	Neff Group Distributors, Inc. Neff Group Distributors, Inc. Neff Group Distributors, Inc.	(260) 489-6007 (317) 841-9244 (574) 272-8282	(260) 489-6204 (317) 841-6480 (574) 277-3240	www.neffengineering.com www.neffengineering.com www.neffengineering.com
Kansas	Merriam	IBT Fluid Power Group	(913) 261-2125	(913) 677-7077	www.ibtinc.com
Kentucky	Louisville	Air Hydro Power - KY	(502) 451-1000	(502) 456-2837	www.airhydropower.com
Michigan	Farmington Hills Grandville Flint Grand Rapids	Exotic Automation & Supply Michigan Fluid Power Inc. Neff Group Distributors, Inc. Neff Group Distributors, Inc.	(248) 477-2122 (616) 538-5700 (810) 232-9350 (616) 554-1974	(248) 477-0427 (616) 538-0888 (810) 232-4169 (616) 554-1197	www.exoticaautomation.com www.mifp.com www.neffengineering.com www.neffengineering.com
Minnesota	Eagan Eden Prairie	John Henry Foster Co. Braas Company	(651) 681-5738 (952) 937-8902	(651) 681-9368 (952) 937-6495	www.jhfoster.com www.braasco.com
Mississippi	Jackson	Franklin Electrofluid Co.	(601) 969-7022	(601) 354-0630	www.frankelectro.com
Missouri	Fenton	Air Specialists Worldwide	(636) 326-5900	(314) 298-0440	www.airspec.com
Nebraska	Omaha	Skarda Equipment Inc.	(316) 265-1329	(402) 345-1567	www.skarda.com
New Jersey	Maplewood	Airoyal Company	(973) 761-4150	(973) 761-5731	www.airoyal.biz
New York	Syracuse	Ralph W. Earl	(315) 454-4431	(315) 454-0977	www.rwearl.com
North Carolina	Concord	Automation Technology (CFT)	(704) 784-8101	(704) 784-8105	www.automationtechnologyinc.com
Ohio	Westlake Franklin	Fluidtrols Corp. Voelker Controls Co.	(440) 835-7010 (937) 433-8128	(440) 835-7041 (937) 433-6076	www.fluidtrols.com/ www.voelker-controls.com
Pennsylvania	Mainland York Houston Warrendale	Air Oil Systems RG Group PACCO - Pennsylvania Controls Huston Industrial Sales	(215) 721-9595 (717) 849-0320 (724) 746-3620 (724) 935-5666	(215) 721-7666 (877) 727-4332 (724) 746-3220 (724) 935-5551	www.airoil.com www.rg-group.com www.pacontrols-pacco.com www.hustonind.com
Tennessee	Nashville Memphis Nashville	Centro, Inc. Franklin Electrofluid Co. Franklin Electrofluid Co.	(615) 255-2220 (901) 362-7504 (615) 399-7700	(615) 255-2212 (901) 362-0343 (615) 399-3133	www.centromemphis.com www.frankelectro.com www.frankelectro.com
Texas	Houston Allen El Paso Laredo Houston	Atlas Industrial Supply Inc. Shepherd Controls & Assoc. Inc. Itech Automation Solutions, Inc. ITRADE INC. Southwestern Controls Div.	(813) 854-1370 (972) 727-7300 (915) 599-3022 (956) 242-7232 (713) 777-2626	(281) 591-6344 (972) 727-7363 (915) 595-4952 (81) 8000-2001 (713) 988-1750	www.aishouston.com www.shepherdcontrols.com www.kopar.com.mx www.kopar.com.mx www.swcontrols.com
Virginia	Fredericksburg	Advanced Pneumatics Co.	(540) 898-4511	(540) 898-2067	www.advvpneumatics.com
Washington	Vancouver	Warden Fluid Dynamics	(360) 696-4946	(360) 694-1768	www.wfdonline.com
Wisconsin	Mequon	Neff Group Distributors, Inc.	(262) 834-6300	(262) 834-6338	www.neffengineering.com

Issue 7.2014. Specifications subject to change

Canada

Location	City	Distributor	Telephone		Internet
British Columbia	Burnaby	Peerless Engineering Sales Ltd.	(604) 659-4100	(604) 659-4121	www.peerlesse.com
Ontario	Stoney Creek	Vickers-Warnick Limited	(905) 643-1448	(905) 643-9785	www.vickers-warnick.com
Quebec	Lachine	Cowper Incorporated	(514) 637-6746	(514) 637-5055	www.copwer.ca

Central America

Location	City	Distributor	Telephone		Internet
Costa Rica	San José	Grupo Kopar	(81) 8000-2000	(81) 8000-2001	www.kopar.com.mx
Mexico	Monterrey	Grupo Kopar	(81) 8000-2000	(81) 8000-2001	www.kopar.com.mx
Puerto Rico	Caguas	P & C Company	(787) 768-5033	(787) 744-8306	N/A
	San Juan	Rafael Benitez Carrillo, Inc./Applied Ind.	(787) 725-7635	(787) 723-1257	http://web.applied.com/base.cfm?page_id=2754





ARGENTINA

CAMOZZI NEUMATICA S.A.
Prof. Dr. Pedro Chutro 3048
1437 Buenos Aires, Argentina
Tel.: +54-11 49110816
Fax: +54-11 49124191
www.camozzi.com.ar

ALTA TECNOLOGIA HIDRAULICA S.A.
Velez Sarsfield 1321
B1824ACK Lanus oeste
Buenos Aires, Argentina
Tel.: +54-11-4249-5770
Fax: +54-11-4247-7238
www.hidromec-hidraulica.com.ar



AUSTRIA

ACE STOSSDÄMPFER GMBH
Albert-Einstein-Straße 15, 40764 Langenfeld
Germany
Tel.: +49-2173-9226-4000
Fax: +49-2173-9226-29
www.ace-ace.de
(distributors on request)



BELARUS

BIBUS (BY) COOO
8th Per. Ilyicha 13a, office 2.1
246013 Gomel, Belarus
Tel.: +375-232 39 09 02
Fax: +375-232 37 10 01
www.bibus.by
(not distributor for gas springs and HB dampers)

For gas springs & HB dampers please contact:

ACE STOSSDÄMPFER GMBH
Albert-Einstein-Straße 15, 40764 Langenfeld
Germany
Tel.: +49-2173-9226-4100
Fax: +49-2173-9226-89
www.ace-ace.com



BELGIUM

ACE STOSSDÄMPFER GMBH
Albert-Einstein-Straße 15, 40764 Langenfeld
Germany
Tel.: +32-(0)11-960736
Fax: +32-(0)11-960737
www.ace-ace.com
(distributors on request)



BOSNIA

BIBUS DOO
Karadordeva bb, 76311 Dvorovi – Bijeljina
Bosnia and Herzegovina
Tel.: +387-55 423 444
Fax: +387-55 423 444
www.bibus.ba
(not distributor for gas springs and HB dampers)

For gas springs & HB dampers please contact:

ACE STOSSDÄMPFER GMBH
Albert-Einstein-Straße 15, 40764 Langenfeld
Germany
Tel.: +49-2173-9226-4100
Fax: +49-2173-9226-89
www.ace-ace.com



BRAZIL

OBR EQUIPAMENTOS
INDUSTRIAIS LTDA.
Rua Piratuba, 1573, Bom Retiro
Joinville-SC (South Brazil)
CEP 89.222-365, Brazil
Tel.: +55-0800 704 3698 / 47 3435 44 64
Fax: +55-47 3425 90 30
www.obr.com.br



BULGARIA

BIBUS BULGARIA LTD.
Tzvetan Lazarov Blv. 2, floor 2, 1574 Sofia, Bulgaria
Tel.: +359-297 19 80 8
Fax: +359-292 73 26 4
www.bibus.bg
(not distributor for gas springs and HB dampers)

For gas springs & HB dampers please contact:

ACE STOSSDÄMPFER GMBH
Albert-Einstein-Straße 15, 40764 Langenfeld
Germany
Tel.: +49-2173-9226-4100
Fax: +49-2173-9226-89
www.ace-ace.com



CHILE

TAYLOR AUTOMATIZACION S.A.
A.V. Vicuna Mackenna, # 1589 Santiago, Chile
Tel.: +56-25 55 15 16
Fax: +56-25 44 19 65
www.taylorautomatizacion.cl



CROATIA

BIBUS ZAGREB D.O.O.
Anina 91, 10000 Zagreb, Croatia
Tel.: +385-1 3818 004
Fax: +385-1 3818 005
www.bibus.hr
(not distributor for gas springs and HB dampers)

For gas springs & HB dampers please contact:

ACE STOSSDÄMPFER GMBH
Albert-Einstein-Straße 15, 40764 Langenfeld
Germany
Tel.: +49-2173-9226-4100
Fax: +49-2173-9226-89
www.ace-ace.com



CZECH REPUBLIC

BIBUS S.R.O.
Videnska 125, 639 27 Brno, Czech Republic
Tel.: +420-547 125 300
Fax: +420-547 125 310
www.bibus.cz
(not distributor for gas springs and HB dampers)

Gas spring & HB damper specialists:

MN-SYSTEMS, S.R.O.
Na Honech I/5538, 760 05 Zlín, Czech Republic
Tel.: +420-734 200 172
Fax: +420-246 013 198
www.mnsystems.cz



DENMARK

AVN AUTOMATION A/S
Bergsoesvej 14, 8600 Silkeborg, Denmark
Tel.: +45-70 20 04 11
Fax: +45-86 80 55 88
www.avn.dk



FINLAND

NESTEPAINNE OY
Makituvantie 11, 01510 Vantaa, Finland
Tel.: +358-20 765 165
Fax: +358-20 765 7666
www.nestepainne.fi

MOVETEC OY
Hannuksentie 1, 02270 Espoo, Finland
Tel.: +358-9 5259 230
Fax: +358-9 5259 2333
www.movetec.fi



FRANCE

BIBUS FRANCE
ZI du Chapotin, 233 rue des frères Voisin
69970 Chaponnay, France
Tel.: +33-4 78 96 80 00
Fax: +33-4 78 96 80 01
www.bibusfrance.fr
(not distributor for gas springs and HB dampers)

For gas springs & HB dampers please contact:

ACE STOSSDÄMPFER GMBH
Albert-Einstein-Straße 15, 40764 Langenfeld
Germany
Tel.: +49-2173-9226-4100
Fax: +49-2173-9226-89
www.ace-ace.com



GREECE

PNEUMATEC INDUSTRIAL
AUTOMATION SYSTEMS
91 Spirou Patsi Street, Athens 11855, Greece
Tel.: +302-1 03412101 / 3413930
Fax: +302-1 03413930



HUNGARY

BIBUS KFT.
1103 Budapest, Ujhegyi ut 2, Hungary
Tel.: +36-1265 27 33
Fax: +36-1264 89 00
www.bibus.hu
(not distributor for gas springs and HB dampers)

Gas spring & HB damper specialists:

DUNA CONSULTING KFT.
Gábor Áron u. 18.
2013 Pomáz, Hungary
Tel.: +36-1 433 4700, +36-30 26 36 576
Fax: +36-1 264 8900
www.acegazrugo.hu



IRELAND

IRISH PNEUMATIC SERVICES LTD.
5A M7 Business Park
Newhall, Naas, Co. Kildare, Ireland
Tel.: +353-45-872590
Fax: +353-45-872595
www.irishpneumaticservices.com



ISRAEL

ILAN & GAVISH
AUTOMATION SERVICE LTD.
24, Shenkar Street, Qiryat-arie 49513
PO Box 10118, Petha-Tiqva 49001, Israel
Tel.: +972-39 22 18 24
Fax: +972-39 24 07 61
www.ilan-gavish.co.il



ITALY

R.T.I. S.R.L.
Via Chambery 93/107V, 10142 Torino, Italy
Tel.: +39-011-70 00 53 / 70 02 32
Fax: +39-011-70 01 41
www.rti-to.it



JORDAN

ATAFAWOK TRADING EST.
PO Box 921797, Amman 11192, Jordan
Tel.: +962-64 02 38 73
Fax: +962-65 92 63 25



LITHUANIA

TECHVITAS
Dubysos g. 66A, 94107 Klaipeda, Lithuania
Tel.: +370-46 355 494
Fax: +370-46 355 493
www.techvitas.lt

LUXEMBOURG
ACE STOSSDÄMPFER GMBH

Albert-Einstein-Straße 15, 40764 Langenfeld
 Germany
 Tel.: +32-(0)11-960736
 Fax: +32-(0)11-960737
 www.ace-ace.com
 (distributors on request)

NETHERLANDS
ACE STOSSDÄMPFER GMBH

Albert-Einstein-Straße 15, 40764 Langenfeld
 Germany
 Tel.: +31-(0)165-714455
 Fax: +31-(0)165-714456
 www.ace-ace.com
 (distributors on request)

NORWAY
OLAER AS.

Dynamitveien 23, Postboks 133, 1401 Ski, Norway
 Tel.: +47-64 91 11 80
 Fax: +47-64 91 11 81
 www.olaer.no

HYDNET AB

Turebergsvagen 5, 191 47 Sollentuna, Sweden
 Tel.: +46-8 59 470 470
 Fax: +46-8 59 470 479
 www.hydnet.se

PAKISTAN
J.J. HYDRAULICS & PNEUMATICS

Hotel Metropole Bldg., Room 127, 1st Floor
 Club Road, Karachi, Pakistan 75520
 Tel.: +92-2 15 66 10 63
 Fax: +92-2 15 66 10 65

POLAND
BIBUS MENOS SP. Z.O.O.

ul. Spadochroniarzy 18, 80-298 Gdańsk, Poland
 Tel.: +48-58 660 95 70
 Fax: +48-58 661 71 32
 www.bibusmenos.pl
 (not distributor for gas springs and HB dampers)

Gas spring & HB damper specialists:
F.H.U. ELMATIC S.C.

ul. Lubicka 20, 87-100 Toruń, Poland
 Tel.: +48-56 659 15 49
 Tel./Fax: +48-56 659 16 81
 www.elmatic.com.pl

PORTUGAL
AIRCONTROL INDUSTRIAL S.L.

Alameda Fernao Lopes 31A
 Torre 2 - Miraflores
 1495-136 Alges (Lisboa), Portugal
 Tel.: +351-21 410 12 57
 Fax: +351-21 410 56 08
 www.aircontrol.es

BIBUS PORTUGAL LDA

Rua 5 de Outubro, 5026
 4465-079 S. Mamede de Infesta, Porto, Portugal
 Tel.: +35-122 906 50 50
 Fax: +35-122 906 50 53
 www.bibus.pt
 (not distributor for gas springs and HB dampers)

ROMANIA
BIBUS SES S.R.L.

134/1 Calea Lugojului, 307200 Ghiroda, Timis, Romania
 Tel.: +40-356 446 500
 Fax: +40-356 446 660
 www.bibus.ro
 (not distributor for gas springs and HB dampers)

Gas spring & HB damper specialists:
D.C. COMPANY S.R.L.

Dragos Voda nr. 43, 300351 Timisoara, Romania
 Tel.: +40-722 145 213
 Fax: +40-356 800 513
 www.ewarehouse.ro

RUSSIA
BIBUS O.O.O.

Izmailovsky prospect 2, letter A
 190005 St. Petersburg, Russia
 Tel.: +7-812 251 62 71
 Fax: +7-812 251 90 14
 www.bibus.ru
 (not distributor for gas springs and HB dampers)

Gas spring & HB damper specialists:
TEHINNOVATION

Krasnodonskaya street 19, office 17
 109386 Moscow, Russia
 Tel.: +7-495 222 06 01
 Fax: +7-499 786 42 56
 www.tehinnovation.ru

SERBIA
BIBUS DOO

Karadordeva bb, 76311 Dvorovi – Bijeljina
 Bosnia and Herzegovina
 Tel.: +387-55 423 444
 Fax: +387-55 423 444
 www.bibus.ba
 (not distributor for gas springs and HB dampers)

For gas springs & HB dampers please contact:
ACE STOSSDÄMPFER GMBH

Albert-Einstein-Straße 15, 40764 Langenfeld
 Germany
 Tel.: +49-2173-9226-4100
 Fax: +49-2173-9226-89
 www.ace-ace.com

SLOVAKIA
BIBUS SK S.R.O.

Trnavska cesta, 94901 Nitra, Slovakia
 Tel.: +421-37 7777 950
 Fax: +421-37 7777 969
 www.bibus.sk
 (not distributor for gas springs and HB dampers)

Gas spring & HB damper specialists:
PNEUTRADE S.R.O.

Rybárska 8, 949 01 Nitra, Slovakia
 Tel.: +421-37/65 24 338
 Fax: +421-37/65 55 933
 www.pneutrade.sk

SLOVENIA
INOTEH D.O.O.

K Zeleznici 7, 2345 Bistrica ob Dravi, Slovenia
 Tel.: +386-02 665 1131
 Fax: +386-02 665 2081
 www.inoteh.si
 (not distributor for gas springs and HB dampers)

For gas springs & HB dampers please contact:
ACE STOSSDÄMPFER GMBH

Albert-Einstein-Straße 15, 40764 Langenfeld
 Germany
 Tel.: +49-2173-9226-4100
 Fax: +49-2173-9226-89
 www.ace-ace.com

SOUTH AFRICA
PNEUMARK CONTROLS

94A Crompton Street, Pinetown, 3610
 South Africa
 Tel.: +27-31 701 0421
 Fax: +27-86 551 2026
 www.pneumark.co.za

SPAIN
AIRCONTROL INDUSTRIAL S.L.

Paseo Sarroeta 4
 20014 Donostia-San Sebastian, Spain
 Tel.: +34-943 44 50 80
 Fax: +34-943 44 51 53
 www.aircontrol.es

BIBUS SPAIN S.L.

Avda Ricardo Mella, 117 D, 36330 Vigo, Spain
 Tel.: +34-986 24 72 86
 Fax: +34-986 20 92 47
 www.bibus.es
 (not distributor for gas springs and HB dampers)

SWEDEN
HYDNET AB

Turebergsvagen 5, 191 47 Sollentuna, Sweden
 Tel.: +46-8 59 470 470
 Fax: +46-8 59 470 479
 www.hydnet.se

SWITZERLAND
BIBUS AG

Allmendstrasse 26, 8320 Fehraltorf, Switzerland
 Tel.: +41-44-877 50 11
 Fax: +41-44-877 58 51
 www.bibus.ch
 (not distributor for gas springs and HB dampers)

For gas springs & HB dampers please contact:
ACE STOSSDÄMPFER GMBH

Albert-Einstein-Straße 15, 40764 Langenfeld
 Germany
 Tel.: +49-2173-9226-4100
 Fax: +49-2173-9226-89
 www.ace-ace.com

TURKEY

BIBUS OTOMASYON SAN. VE TIC. LTD. STI.
 Necatibey Cad. No:49 Kat:2
 34425 Karakoy/Istanbul, Turkey
 Tel.: +90-212 293 82 00
 Fax: +90-212 249 88 34
 www.bibus.com.tr
 (not distributor for gas springs and HB dampers)

Gas spring & HB damper specialists:
POVVER PNÖMATİK A.S.

Necatibey Cad. No:44 Kat:2
 34425 Karaköy/Istanbul, Turkey
 Tel.: +90-212 2938870
 Fax: +90-212 2936877
 www.powerpnomatik.com

UKRAINE

BIBUS UKRAINE TOV
 Mashinobudivnykiv Str., 5A
 Chabany, 08162 Kiev Region, Ukraine
 Tel.: +380-44 545 44 04
 Fax: +380-44 545 54 83
 www.bibus.com.ua
 (not distributor for gas springs and HB dampers)

For gas springs & HB dampers please contact:
ACE STOSSDÄMPFER GMBH

Albert-Einstein-Straße 15, 40764 Langenfeld
 Germany
 Tel.: +49-2173-9226-4100
 Fax: +49-2173-9226-89
 www.ace-ace.com



USA

ACE CONTROLS INC.

23435 Industrial Park Dr., Farmington Hills

MI 48335, USA

Tel.: +1-248-476-0213

Fax: +1-248-476-2470

www.acecontrols.com



GERMANY

ACE STOSSDÄMPFER GMBH

Albert-Einstein-Straße 15

40764 Langenfeld, Germany

Tel.: +49-(0) 2173-9226-10

Fax: +49-(0) 2173-9226-19

www.ace-ace.de



GREAT BRITAIN

ACE CONTROLS INTERNATIONAL

Unit 404 Easter Park, Haydock Lane

Haydock, WA11 9TH, U.K.

Tel.: +44-(0) 1942 727440

Fax: +44-(0) 1942 717273

www.ace-controls.co.uk



JAPAN

ACE CONTROLS JAPAN L.L.C.

City Center Bldg. II 2fl

3-1-42, Chigasaki-minami, Tsuzuki-ku

Yokohama, 224-0037, Japan

Tel.: +81-(45) 945-0123

Fax: +81-(45) 945-0122

www.acecontrols.co.jp



P. R. CHINA

ACE CONTROLS (SUZHOU) CO. LTD.

Building 7 East, No. 369 Lushan Road, Suzhou

Jiangsu Province 215129, P. R. China

Tel.: +86-(512) 88606699

Fax: +86-(512) 88606698

www.acecontrols.cn.com



**Distributors in other countries
see pages 210 and 211.**

ACE Controls Inc.

23435 Industrial Park Dr., Farmington Hills, MI 48335

Tel. +1-248-476-0213 · Fax +1-248-476-2470 · shocks@acecontrols.com · www.acecontrols.com

an SKF Group brand

SKF