

Damping Technology

ACE: Your partner for industrial shock absorbers,
gas springs and vibration control

Main Catalogue 2017



**Complete Product Range
Data Sheets & Catalogues
CAD Database
Free Calculation Programs
Distributors
Services
News
etc.**

www.ace-ace.com

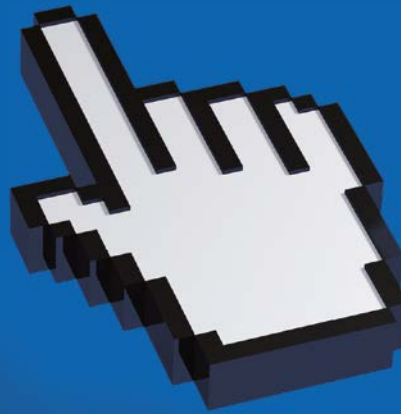

Dear customer,

You have made the right decision.

You will find 300 pages of comprehensive information on the application fields of automation control, motion control, vibration control and safety products. Each section is marked with a different colour. This integrated concept is reflected in all documentation, the demonstration vehicle, our exhibition stand and our www.ace-ace.com website. Our web presentation, the tool for professionals, also offers the ACE YouTube channel with an extensive CAD library and calculation aids.

Innovations can as usual be found in the table of contents and on the individual catalogue pages.

ACE products assist you in making your production and processes faster, more efficient, quieter, easier, safer and more sustainable – underpinned by ACE product quality and our 5 star service.

Your

Jürgen Roland (Managing Director)



Free Service Hotline

Tell us about your requirements and take advantage of our more than 40 years of expert knowledge in damping technology. Our specialists in engineering discuss your requirements with you and demonstrate our possibilities. Take advantage of our service hotline

T +49 (0)2173 - 9226-4100

Also, our regional managers are genuine shock absorber specialists. They will visit you onsite, note down the field data and work out customized solutions for you.

Furthermore: ACE service support and products are available in more than 40 countries worldwide.

CAD Online Calculation Program

With our user-friendly calculation program in the internet you can select the right product – online or via download of the program. The CAD data is available in all standard formats in 2D and 3D.

www.ace-ace.com

Our specialist engineers create detailed technical solutions for you including assembly suggestions and details on machine loads, brake time and workload etc.

Automation Control

Motion Control

Vibration Control

Safety Products



Certified Quality

ACE products are exclusively manufactured from high quality and environmentally compatible materials. With permanent quality monitoring and the performance of test programs, a constant high quality can be guaranteed.

ACE pursues continual improvement in all areas in order to arrange material and energy consumption, the production of damaging substances and recycling or disposal of end products as gently on resources as possible.

It is important to us to keep the strain on the environment as low as possible and simultaneously improve our services.

With ongoing optimisation of end products, we also give our customers the option of designing their products to be smaller, more effective and more energy-saving.



Miniature Shock Absorbers, Industrial Shock Absorbers, Heavy Industrial Shock Absorbers, Pallet Stoppers, Profile Dampers, Damping Pads



Industrial Gas Springs (push type), Industrial Gas Springs (pull type), Hydraulic Dampers, Hydraulic Feed Controls, Door Dampers, Rotary Dampers



Rubber-Metal Isolators, Vibration-Isolating Pads, Low Frequency Pneumatic Levelling Mounts



Safety Shock Absorbers, Safety Dampers, Clamping Elements

We are your Specialists for Industrial Damping Technology

ACE is the world's globally recognized specialist in the field of industrial damping technology – with agencies in 45 countries on all continents. ACE has also been represented in Germany since 1978. Here 25 engineers work every day on the further development of the product range.

ACE customers benefit from sophisticated solutions, valuable innovations and exemplary service around the topic of damping technology. Through close cooperation with leading engineering companies, in particular the German ACE subsidiary has established itself as a pioneer in the field of technical progress in damping technology.

This catalogue is the decisive step to let the frequently expressed customer request come true: to supply everything for damping technology and vibration isolation from one single source.

ACE develops, produces and sells a wide range of damping products. It comprises industrial and safety shock absorbers, profile dampers, rotary dampers, industrial gas springs, hydraulic dampers, vibration isolators, air springs and hydraulic feed controls.

The products assert themselves particularly in future-oriented companies because there are virtually no better solutions to quickly, gently and precisely slow down moving masses or to isolate harmful vibrations.

ACE Product Variety

Concentrated competence on more than 300 pages



Page	
6	Automation Control
8 - 9	Industrial shock absorbers – general information
10 - 13	Formulae and calculations
14 - 15	Industrial shock absorbers – capacity chart
16	Miniature Shock absorbers
	Product families
18 - 35	Accessories M5 to M25 – selection chart
36 - 37	Accessories M5 to M25 – overview
38 - 42	Accessories M5 to M25 – technical information
43 - 46	Accessories M5 to M25 – technical information
48 - 49	Application examples
50	Industrial Shock Absorbers
	Product families
52 - 73	Accessories M33 to M64 – overview
74 - 76	Accessories M33 to M64 – technical information
77	Accessories M33 to M64 – technical information
78 - 79	Application examples
80	Heavy Industrial Shock Absorbers
	Product families
82 - 89	Special accessories – air/oil tanks
90 - 91	Special accessories – air/oil tanks
92	Pallet Stoppers
96	Profile Dampers TUBUS
98 - 99	Profile dampers – capacity chart
100 - 111	Product families
112 - 113	Application examples
114	Profile Dampers TUBUS Special
116	Damping Pads SLAB
	Product families
118 - 124	Adhesive recommendation and technical information
125	Chemical resistance
126	Chemical resistance
127	Sample pads
128 - 129	Application examples

130**Motion Control****132****Gas Springs – Push Type**

134 - 155

Product families

153

Further stainless steel gas springs – capacity chart

156 - 157

Application examples

158**Gas Springs – Pull Type**

160 - 170

Product families

171

Further stainless steel gas springs – capacity chart

172 - 173

Gas spring calculation service and fax formular

174

Mounting and safety instructions

175

Special accessories – valve actuation and refilling kit

176**Hydraulic Dampers**

178 - 197

Product families

198 - 199

Application examples

200 - 213

Accessories for gas springs and hydraulic dampers

214**Hydraulic Feed Controls**

216 - 219

Product families**220****Rotary Dampers**

224 - 237

Product families

238

Calculations and accessories

239

Application examples

240**Vibration Control**

242

Vibration isolation

243**Rubber-Metal Isolators****244****Vibration-Isolating Pads****245****Low Frequency Pneumatic Levelling Mounts****246****Safety Products****248****Safety Shock Absorbers**

250 - 263

Product families

264

General instructions

265

Formulae and calculations

266 - 267

Application examples

268**Safety Dampers TUBUS**

270 - 273

Product families**274****Clamping Elements**

276 - 278

Clamp versions

280 - 296

Product families

297 - 298

Application examples

Automation Control

Miniature Shock Absorbers, Industrial Shock Absorbers
Heavy Industrial Shock Absorbers, Pallet Stoppers
Profile Dampers, Damping Pads

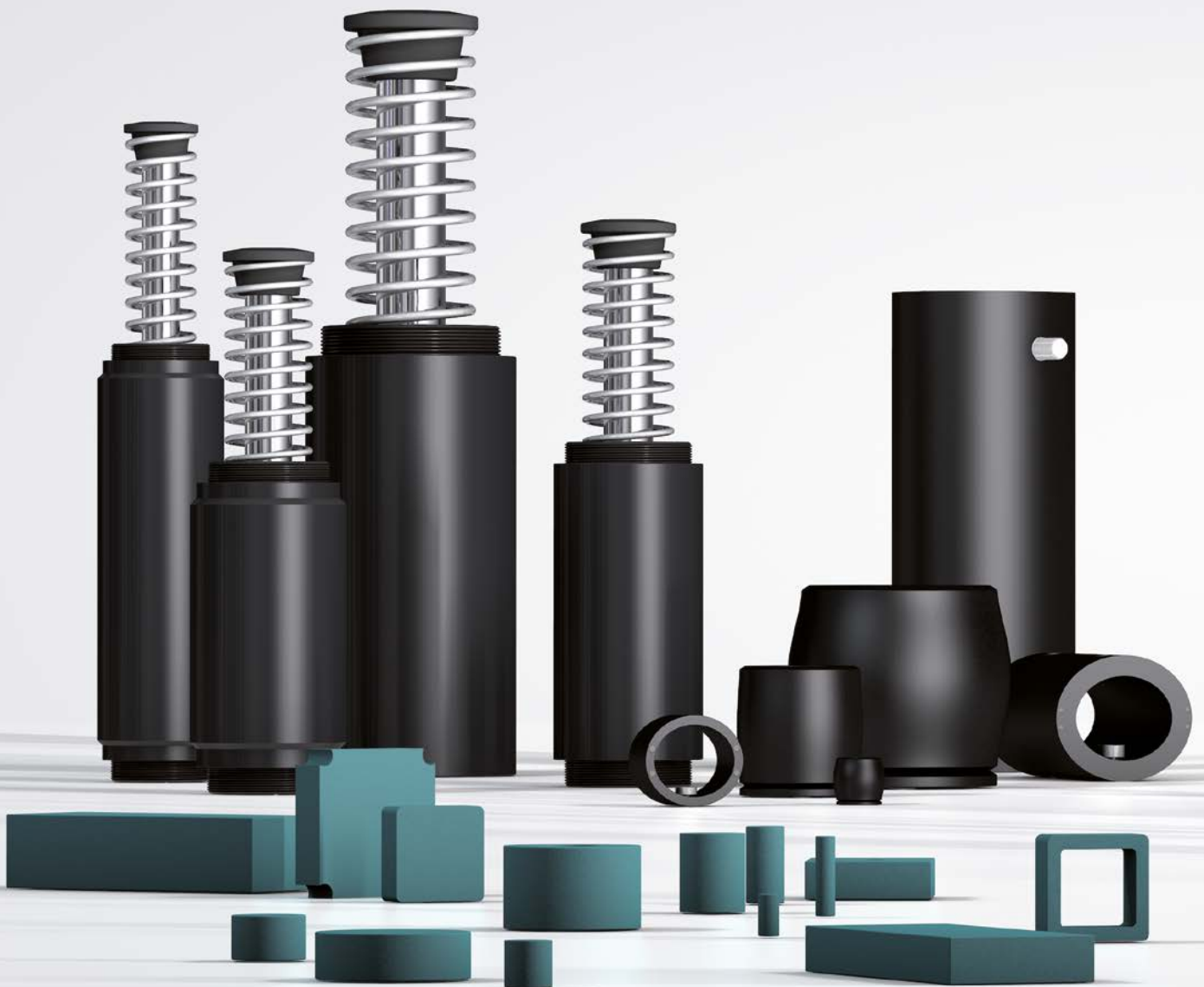

Optimum Tuning

Tailor-made solutions for any application

Kinetic energy is turned into heat by the universal use ACE damping solutions. This makes machines faster, quieter, more durable, lighter and therefore more competitive and profitable.

Here you will find the perfect selection of machine element, which turn damaging forces into harmless heat. These solutions from ACE smoothly decelerate moving loads. This involves the lowest possible strain on machines, which makes the damping products from ACE so valuable.



Industrial Shock Absorbers

Standard-setting damping solutions

The name says it all: ACE Stoßdämpfer GmbH (“the ACE shock absorber company”). That ACE is considered the technology and market leader on a worldwide scale for small, medium-sized and heavy industrial shock absorbers is a result of the successful blend of quality, performance and the durability of the solutions.

ACE provides the right shock absorber for every industrial purpose. Over 200 different models are available, from the smallest model with a 4 mm stroke up to the biggest with 406 mm.

Whether self-compensating or adjustable, with ACE dampers between 0.68 Nm/cycle and 126,500 Nm/cycle can be absorbed and effective weights between 500 g and 204 t can be decelerated with great precision.

In addition, ACE damping solutions impress with competent consulting, exemplary service and ideal matching accessories.

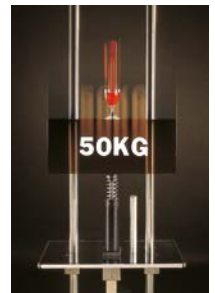

ACE demo showing a wine glass dropping free fall 1.3 m. Decelerated by a shock absorber not a drop of wine is spilled.

Stopping with Industrial Shock Absorbers

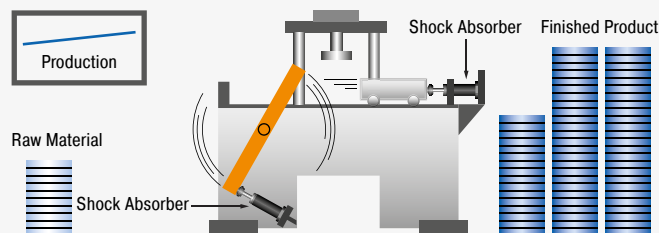

Your advantages using industrial shock absorbers

- Safe, reliable production
- Long service life of the machines
- Easy, inexpensive constructions
- Low operating costs
- Quiet, economical machines
- Less stress on the machine
- Profit improvement

Stopping with Rubber Buffers, Springs, Dashpots or Cylinder Cushions

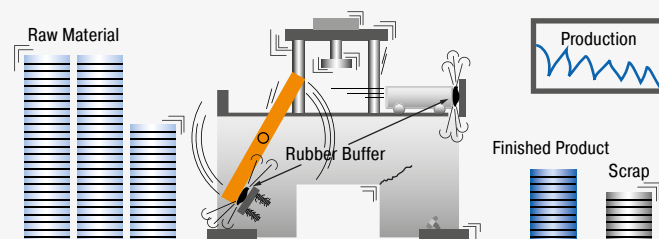

Results using conventional dampers

- Loss of production
- Machine damage
- Increased maintenance costs
- Increased operating noise
- Higher machine construction costs

Comparison of Different Damping Elements

When it comes to slowing down moving masses with constant damping force through the stroke, the industrial shock absorber is the right choice. A comparison demonstrates the differences of the damping elements.

ACE Industrial Shock Absorbers (Uniform stopping force through the entire stroke)

The moving load is smoothly and gently brought to rest by a constant resisting force throughout the entire shock absorber stroke. The load is decelerated with the lowest possible force in the shortest possible time eliminating damaging force peaks and shock damage to machines and equipment. This is a linear deceleration force stroke curve and is the curve provided by ACE industrial shock absorbers. In addition they considerably reduce noise pollution.

Hydraulic Dashpot (High stopping force at start of the stroke)

With only one metering orifice the moving load is abruptly slowed down at the start of the stroke. The braking force rises to a very high peak at the start of the stroke (giving high shock loads) and then falls away rapidly.

Springs and Rubber Buffers (High stopping forces at end of stroke)

At full compression. Also they store energy rather than dissipating it, causing the load to rebound back again.

Air Buffers, Pneumatic Cylinder Cushions (High stopping force at end of stroke)

Due to the compressibility of air these have a sharply rising force characteristic towards the end of the stroke. The majority of the energy is absorbed near the end of the stroke.

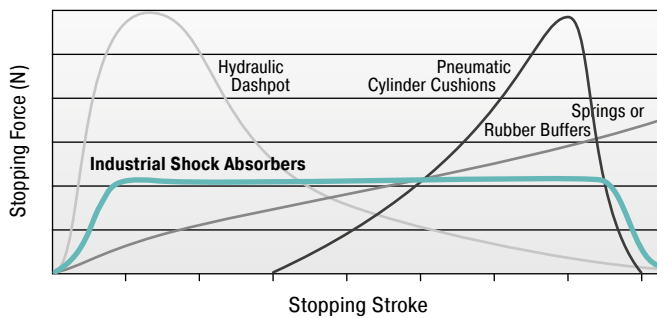

Comparison

The comparison shows the differences of the damping in a direct comparison of stopping force to stopping stroke.

General Function of the Pressure Chamber

If a moving mass hits the industrial shock absorber, the piston puts the oil in the pressure chamber into motion. The oil is pressed through the metering orifices, which converts the discharged energy into heat. The metering orifices are arranged on the stroke so that the mass is retarded with a constant damping force. The hydraulic pressure is maintained throughout the entire braking process nearly constant.

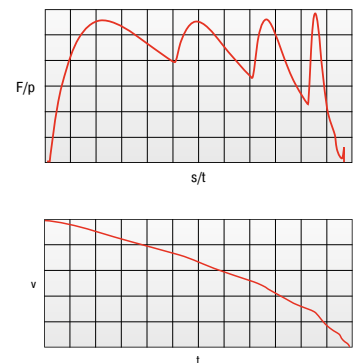
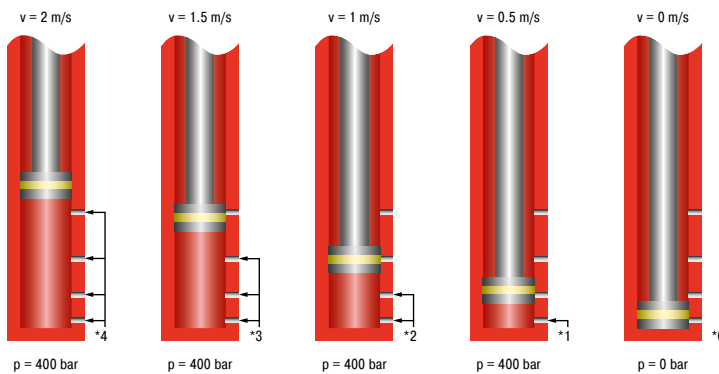

* The load velocity reduces continuously as you travel through the stroke due to the reduction in the number of metering orifices (*) in action. The internal pressure remains essentially constant and thus the force vs. stroke curve remains linear.

F = force (N), p = internal pressure (bar)
s = stroke (m), t = deceleration time (s),
v = velocity (m/s)

Calculation Bases for the Design of Industrial Shock Absorbers

ACE shock absorbers provide linear deceleration and are therefore superior to other kinds of damping element. It is easy to calculate around 90 % of applications knowing only the following five parameters:

- | | | |
|---|----------------------|--------------|
| 1. Mass to be decelerated (weight) | m | [kg] |
| 2. Impact velocity at shock absorber | v_D | [m/s] |
| 3. Propelling force | F | [N] |
| 4. Cycles per hour | c | [/hr] |
| 5. Number of absorbers in parallel | n | |

Key to symbols used

W ₁	Kinetic energy per cycle	Nm	³ ST	tall torque factor (normally 2.5)	1 to 3
W ₂	Propelling force energy per cycle	Nm	M	Propelling torque	Nm
W ₃	Total energy per cycle (W ₁ + W ₂)	Nm	I	Moment of Inertia	kgm ²
¹ W ₄	Total energy per hour (W ₃ · c)	Nm/hr	g	Acceleration due to gravity = 9.81	m/s ²
me	Effective weight	kg	h	Drop height excl. shock absorber stroke	m
m	Mass to be decelerated	kg	s	Shock absorber stroke	m
n	Number of shock absorbers (in parallel)		L/R/r	Radius	m
² v	Velocity at impact	m/s	Q	Reaction force	N
² v _D	Impact velocity at shock absorber	m/s	μ	Coefficient of friction	
ω	Angular velocity at impact	rad/s	t	Deceleration time	s
F	Propelling force	N	a	Deceleration	m/s ²
c	Cycles per hour	1/hr	α	Side load angle	°
P	Motor power	kW	β	Angle of incline	°

¹ All mentioned values of W₄ in the capacity charts are only valid for room temperature. There are reduced values at higher temperature ranges.

² v or v_D is the final impact velocity of the mass. With accelerating motion the final impact velocity can be 1.5 to 2 times higher than the average. Please take this into account when calculating kinetic energy.

³ ST ≙ relation between starting torque and running torque of the motor (depending on the design)

In all the following examples the choice of shock absorbers made from the capacity chart is based upon the values of (W₃), (W₄), (me) and the desired shock absorber stroke (s).

Note:

When using several shock absorbers in parallel, the values (W₃), (W₄) and (me) are divided according to the number of units used.

Reaction force Q [N] $Q = \frac{1.5 \cdot W_3}{s}$

Stopping time t [s] $t = \frac{2.6 \cdot s}{v_D}$

Deceleration rate a [m/s²] $a = \frac{0.75 \cdot v_D^2}{s}$

Approximate values assuming correct adjustment. Add safety margin if necessary.
(Exact values will depend upon actual application data and can be provided on request.)

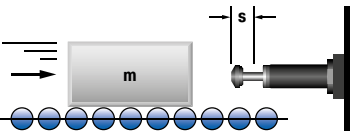
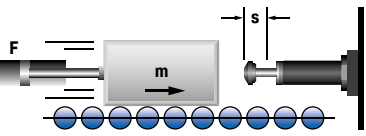
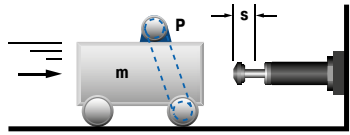
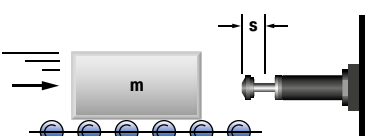
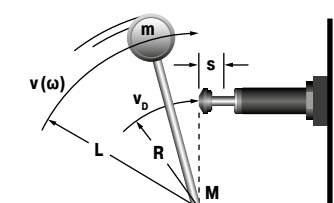
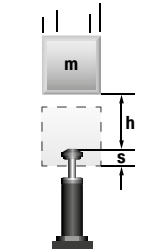
Application	Formulae	Example
1 Mass without propelling force 	$W_1 = m \cdot v^2 \cdot 0.5$ $W_2 = 0$ $W_3 = W_1 + W_2$ $W_4 = W_3 \cdot c$ $v_D = v$ $me = m$	$m = 100 \text{ kg}$ $v = 1.5 \text{ m/s}$ $c = 500 \text{ /hr}$ $s = 0.050 \text{ m (chosen)}$ $W_1 = 100 \cdot 1.5^2 \cdot 0.5 = 113 \text{ Nm}$ $W_2 = 0$ $W_3 = 113 + 0 = 113 \text{ Nm}$ $W_4 = 113 \cdot 500 = 56500 \text{ Nm/hr}$ $me = m = 100 \text{ kg}$ Chosen from capacity chart: Model MC3350EUM-2 self-compensating
2 Mass with propelling force 	$W_1 = m \cdot v^2 \cdot 0.5$ $W_2 = F \cdot s$ $W_3 = W_1 + W_2$ $W_4 = W_3 \cdot c$ $v_D = v$ $me = \frac{2 \cdot W_3}{v_D^2}$	$m = 36 \text{ kg}$ $v = 1.5 \text{ m/s}$ $F = 400 \text{ N}$ $c = 1000 \text{ /hr}$ $s = 0.025 \text{ m (chosen)}$ $W_1 = 36 \cdot 1.5^2 \cdot 0.5 = 41 \text{ Nm}$ $W_2 = 400 \cdot 0.025 = 10 \text{ Nm}$ $W_3 = 41 + 10 = 51 \text{ Nm}$ $W_4 = 51 \cdot 1000 = 51000 \text{ Nm/hr}$ $me = 2 \cdot 51 : 1.5^2 = 45 \text{ kg}$ Chosen from capacity chart: Model MC600EUM self-compensating v is the final impact velocity of the mass: With pneumatically propelled systems this can be 1.5 to 2 times the average velocity. Please take this into account when calculating energy.
2.1 for vertical motion upwards → 2.2 for vertical motion downwards →	$W_2 = (F - m \cdot g) \cdot s$ $W_2 = (F + m \cdot g) \cdot s$	
3 Mass with motor drive 	$W_1 = m \cdot v^2 \cdot 0.5$ $W_2 = \frac{1000 \cdot P \cdot ST \cdot s}{v}$ $W_3 = W_1 + W_2$ $W_4 = W_3 \cdot c$ $v_D = v$ $me = \frac{2 \cdot W_3}{v_D^2}$	$m = 800 \text{ kg}$ $v = 1.2 \text{ m/s}$ $ST = 2.5$ $P = 4 \text{ kW}$ $c = 100 \text{ /hr}$ $s = 0.100 \text{ m (chosen)}$ $W_1 = 800 \cdot 1.2^2 \cdot 0.5 = 576 \text{ Nm}$ $W_2 = 1000 \cdot 4 \cdot 2.5 \cdot 0.1 : 1.2 = 834 \text{ Nm}$ $W_3 = 576 + 834 = 1410 \text{ Nm}$ $W_4 = 1410 \cdot 100 = 141000 \text{ Nm/hr}$ $me = 2 \cdot 1410 : 1.2^2 = 1958 \text{ kg}$ Chosen from capacity chart: Model MC64100EUM-2 self-compensating Note: Do not forget to include the rotational energy of motor, coupling and gearbox into calculation for W_1 .
4 Mass on driven rollers 	$W_1 = m \cdot v^2 \cdot 0.5$ $W_2 = m \cdot \mu \cdot g \cdot s$ $W_3 = W_1 + W_2$ $W_4 = W_3 \cdot c$ $v_D = v$ $me = \frac{2 \cdot W_3}{v_D^2}$	$m = 250 \text{ kg}$ $v = 1.5 \text{ m/s}$ $c = 180 \text{ /hr}$ $(\text{Steel/Steel}) \mu = 0.2$ $s = 0.050 \text{ m (chosen)}$ $W_1 = 250 \cdot 1.5^2 \cdot 0.5 = 281 \text{ Nm}$ $W_2 = 250 \cdot 0.2 \cdot 9.81 \cdot 0.05 = 25 \text{ Nm}$ $W_3 = 281 + 25 = 306 \text{ Nm}$ $W_4 = 306 \cdot 180 = 55080 \text{ Nm/hr}$ $me = 2 \cdot 306 : 1.5^2 = 272 \text{ kg}$ Chosen from capacity chart: Model MC4550EUM-2 self-compensating
5 Swinging mass with propelling force 	$W_1 = m \cdot v^2 \cdot 0.5 = 0.5 \cdot l \cdot \omega^2$ $W_2 = \frac{M \cdot s}{R}$ $W_3 = W_1 + W_2$ $W_4 = W_3 \cdot c$ $v_D = \frac{v \cdot R}{L} = \omega \cdot R$ $me = \frac{2 \cdot W_3}{v_D^2}$	$m = 20 \text{ kg}$ $v = 1 \text{ m/s}$ $M = 50 \text{ Nm}$ $R = 0.5 \text{ m}$ $L = 0.8 \text{ m}$ $c = 1500 \text{ /hr}$ $s = 0.012 \text{ m (chosen)}$ $W_1 = 20 \cdot 1^2 \cdot 0.5 = 10 \text{ Nm}$ $W_2 = 50 \cdot 0.012 : 0.5 = 1.2 \text{ Nm}$ $W_3 = 10 + 1.2 = 11.2 \text{ Nm}$ $W_4 = 11.2 \cdot 1500 = 16800 \text{ Nm/hr}$ $v_D = 1 \cdot 0.5 : 0.8 = 0.63 \text{ m/s}$ $me = 2 \cdot 11.2 : 0.63^2 = 56 \text{ kg}$ Chosen from capacity chart: Model MC150EUMH self-compensating Check the side load angle, $\tan \alpha = s/R$, with regard to "Max. Side Load Angle" in the capacity chart (see example 6.2)
6 Free falling mass 	$W_1 = m \cdot g \cdot h$ $W_2 = m \cdot g \cdot s$ $W_3 = W_1 + W_2$ $W_4 = W_3 \cdot c$ $v_D = \sqrt{2 \cdot g \cdot h}$ $me = \frac{2 \cdot W_3}{v_D^2}$	$m = 30 \text{ kg}$ $h = 0.5 \text{ m}$ $c = 400 \text{ /hr}$ $s = 0.050 \text{ m (chosen)}$ $W_1 = 30 \cdot 0.5 \cdot 9.81 = 147 \text{ Nm}$ $W_2 = 30 \cdot 9.81 \cdot 0.05 = 15 \text{ Nm}$ $W_3 = 147 + 15 = 162 \text{ Nm}$ $W_4 = 162 \cdot 400 = 64800 \text{ Nm/hr}$ $v_D = \sqrt{2 \cdot 9.81 \cdot 0.5} = 3.13 \text{ m/s}$ $me = 2 \cdot 162 : 3.13^2 = 33 \text{ kg}$ Chosen from capacity chart: Model MC3350EUM-1 self-compensating

Application	Formulae	Example
6.1 Mass rolling/sliding down incline 	$W_1 = m \cdot g \cdot h = m \cdot v_D^2 \cdot 0.5$ $W_2 = m \cdot g \cdot \sin\beta \cdot s$ $W_3 = W_1 + W_2$ $W_4 = W_3 \cdot c$ $v_D = \sqrt{2 \cdot g \cdot h}$ $me = \frac{2 \cdot W_3}{v_D^2}$	$m = 500 \text{ kg}$ $h = 0.1 \text{ m}$ $c = 200 \text{ /hr}$ $\beta = 10 \text{ }^\circ\text{C}$ $W_1 = 500 \cdot 9.81 \cdot 0.1 = 490.5 \text{ Nm}$ $W_2 = 50 \cdot 9.81 \cdot \sin(10) \cdot 0.075 = 63.9 \text{ Nm}$ $W_3 = 490.5 + 63.9 = 554.4 \text{ Nm}$ $W_4 = 554.4 \cdot 200 = 11880.0 \text{ Nm/hr}$ Chosen from capacity chart: Model MC4575EUM-2 self-compensating
6.1a propelling force up incline 6.1b propelling force down incline	$W_2 = (F - m \cdot g \cdot \sin\beta) \cdot s$ $W_2 = (F + m \cdot g \cdot \sin\beta) \cdot s$	
6.2 Mass free falling about a pivot point 	$W_1 = m \cdot g \cdot h$ $W_2 = 0$ $W_3 = W_1 + W_2$ $W_4 = W_3 \cdot c$ $v_D = \sqrt{2 \cdot g \cdot h} \cdot \frac{R}{L}$ $me = \frac{2 \cdot W_3}{v_D^2}$	$m = 50 \text{ kg}$ $h = 1 \text{ m}$ $c = 50 \text{ /hr}$ $R = 300 \text{ mm}$ $L = 500 \text{ mm}$ $W_1 = 50 \cdot 9.81 \cdot 1 = 490.5 \text{ Nm}$ $W_2 = 0$ $W_3 = 490.5 + 0 = 490.5 \text{ Nm}$ $W_4 = 490.5 \cdot 50 = 24525.0 \text{ Nm/hr}$ Chosen from capacity chart: Model MC4550EUM-1 self-compensating Check the side load angle, $\tan \alpha = s/R$, with regard to "Max. Side Load Angle" in the capacity chart
7 Rotary index table with propelling torque 	$W_1 = m \cdot v^2 \cdot 0.25 = 0.5 \cdot l \cdot \omega^2$ $W_2 = \frac{M \cdot s}{R}$ $W_3 = W_1 + W_2$ $W_4 = W_3 \cdot c$ $v_D = \frac{v \cdot R}{L} = \omega \cdot R$ $me = \frac{2 \cdot W_3}{v_D^2}$	$m = 1000 \text{ kg}$ $v = 1.1 \text{ m/s}$ $M = 1000 \text{ Nm}$ $s = 0.050 \text{ m (chosen)}$ $L = 1.25 \text{ m}$ $R = 0.8 \text{ m}$ $c = 100 \text{ /hr}$ $W_1 = 1000 \cdot 1.1^2 \cdot 0.25 = 303 \text{ Nm}$ $W_2 = 300 \cdot 0.025 \cdot 0.8 = 63 \text{ Nm}$ $W_3 = 28 + 9 = 366 \text{ Nm}$ $W_4 = 37 \cdot 1200 = 36600 \text{ Nm/hr}$ $v_D = 1.1 \cdot 0.8 \cdot 1.25 = 0.7 \text{ m/s}$ $me = 2 \cdot 366 \cdot 0.7^2 = 1494 \text{ kg}$ Chosen from capacity chart: Model MC4550EUM-3 self-compensating Check the side load angle, $\tan \alpha = s/R$, with regard to "Max. Side Load Angle" in the capacity chart (see example 6.2)
8 Swinging arm with propelling torque (uniform weight distribution) 	$W_1 = m \cdot v^2 \cdot 0.17 = 0.5 \cdot l \cdot \omega^2$ $W_2 = \frac{M \cdot s}{R}$ $W_3 = W_1 + W_2$ $W_4 = W_3 \cdot c$ $v_D = \frac{v \cdot R}{L} = \omega \cdot R$ $me = \frac{2 \cdot W_3}{v_D^2}$	$l = 56 \text{ kgm}^2$ $\omega = 1 \text{ rad/s}$ $M = 300 \text{ Nm}$ $s = 0.025 \text{ m (chosen)}$ $L = 1.5 \text{ m}$ $R = 0.8 \text{ m}$ $c = 1200 \text{ /hr}$ $W_1 = 0.5 \cdot 56 \cdot 1^2 = 28 \text{ Nm}$ $W_2 = 300 \cdot 0.025 \cdot 0.8 = 9 \text{ Nm}$ $W_3 = 28 + 9 = 37 \text{ Nm}$ $W_4 = 37 \cdot 1200 = 44400 \text{ Nm/hr}$ $v_D = 1 \cdot 0.8 = 0.8 \text{ m/s}$ $me = 2 \cdot 37 \cdot 0.8^2 = 116 \text{ kg}$ Chosen from capacity chart: Model MC600EUM self-compensating Check the side load angle, $\tan \alpha = s/R$, with regard to "Max. Side Load Angle" in the capacity chart (see example 6.2)
9 Swinging arm with propelling force (uniform weight distribution) 	$W_1 = m \cdot v^2 \cdot 0.17 = 0.5 \cdot l \cdot \omega^2$ $W_2 = \frac{F \cdot r \cdot s}{R} = \frac{M \cdot s}{R}$ $W_3 = W_1 + W_2$ $W_4 = W_3 \cdot c$ $v_D = \frac{v \cdot R}{L} = \omega \cdot R$ $me = \frac{2 \cdot W_3}{v_D^2}$	$m = 1000 \text{ kg}$ $v = 2 \text{ m/s}$ $F = 7000 \text{ N}$ $M = 4200 \text{ Nm}$ $s = 0.050 \text{ m (chosen)}$ $r = 0.6 \text{ m}$ $R = 0.8 \text{ m}$ $L = 1.2 \text{ m}$ $c = 900 \text{ /hr}$ $W_1 = 1000 \cdot 2^2 \cdot 0.17 = 680 \text{ Nm}$ $W_2 = 7000 \cdot 0.6 \cdot 0.05 : 0.8 = 263 \text{ Nm}$ $W_3 = 680 + 263 = 943 \text{ Nm}$ $W_4 = 943 \cdot 900 = 848700 \text{ Nm/hr}$ $v_D = 2 \cdot 0.8 \cdot 1.2 = 1.33 \text{ m/s}$ $me = 2 \cdot 943 \cdot 1.33^2 = 1066 \text{ kg}$ Chosen from capacity chart: Model CA2x2EU-1 self-compensating
10 Mass lowered at controlled speed 	$W_1 = m \cdot v^2 \cdot 0.5$ $W_2 = m \cdot g \cdot s$ $W_3 = W_1 + W_2$ $W_4 = W_3 \cdot c$ $v_D = v$ $me = \frac{2 \cdot W_3}{v_D^2}$	$m = 6000 \text{ kg}$ $v = 1.5 \text{ m/s}$ $s = 0.305 \text{ m (chosen)}$ $c = 60 \text{ /hr}$ $W_1 = 6000 \cdot 1.5^2 \cdot 0.5 = 6750 \text{ Nm}$ $W_2 = 6000 \cdot 9.81 \cdot 0.305 = 17952 \text{ Nm}$ $W_3 = 6750 + 17952 = 24702 \text{ Nm}$ $W_4 = 24702 \cdot 60 = 1482120 \text{ Nm/hr}$ $me = 2 \cdot 24702 \cdot 1.5^2 = 21957 \text{ kg}$ Chosen from capacity chart: Model CA3x12EU-2 self-compensating

Effective Weight (me)

The effective weight (me) can either be the same as the actual weight (examples A and C), or it can be an imaginary weight representing a combination of the propelling force or lever action plus the actual weight (examples B and D).

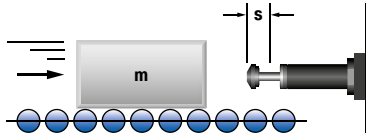
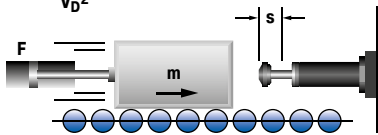
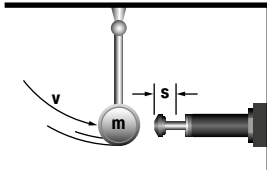
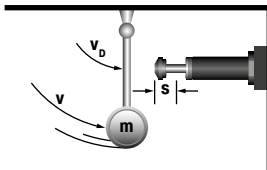
Application	Example
<p>A Mass without propelling force</p> <p>Formula $me = m$</p> 	<p> $m = 100 \text{ kg}$ $v_D = v = 2 \text{ m/s}$ $W_1 = W_3 = 200 \text{ Nm}$ $me = \frac{2 \cdot 200}{4} = 100 \text{ kg}$ </p>
<p>B Mass with propelling force</p> <p>Formula $me = \frac{2 \cdot W_3}{v_D^2}$</p> 	<p> $m = 100 \text{ kg}$ $F = 2000 \text{ N}$ $v_D = v = 2 \text{ m/s}$ $s = 0.1 \text{ m}$ $W_1 = 200 \text{ Nm}$ $W_2 = 200 \text{ Nm}$ $W_3 = 400 \text{ Nm}$ $me = \frac{2 \cdot 400}{4} = 200 \text{ kg}$ </p>
<p>C Mass without propelling force direct against shock absorber</p> <p>Formula $me = m$</p> 	<p> $m = 20 \text{ kg}$ $v_D = v = 2 \text{ m/s}$ $s = 0.1 \text{ m}$ $W_1 = W_3 = 40 \text{ Nm}$ $me = \frac{2 \cdot 40}{2^2} = 20 \text{ kg}$ </p>
<p>D Mass without propelling force with mechanical advantage</p> <p>Formula $me = \frac{2 \cdot W_3}{v_D^2}$</p> 	<p> $m = 20 \text{ kg}$ $v = 2 \text{ m/s}$ $v_D = 0.5 \text{ m/s}$ $s = 0.1 \text{ m}$ $W_1 = W_3 = 40 \text{ Nm}$ $me = \frac{2 \cdot 40}{0.5^2} = 320 \text{ kg}$ </p>

Self-Compensating Shock Absorbers

TYPES	Stroke mm	Energy capacity Nm/cycle	Effective Weight		Page
			me min. kg	me max. kg	
MC5EUM-1-B	4	0.68	0.5	4.4	19
MC5EUM-2-B	4	0.68	3.8	10.8	19
MC5EUM-3-B	4	0.68	9.7	18.7	19
MC9EUM-1-B	5	1	0.6	3.2	19
MC9EUM-2-B	5	1	0.8	4.1	19
MC10EUMH-B	5	1.25	0.7	5	19
MC10EUML-B	5	1.25	0.3	2.7	19
MC25EUM	6	2.8	1.8	5.4	19
MC25EUMH	6	2.8	4.6	13.6	19
MC25EUML	6	2.8	0.7	2.2	19
MC30EUM-1	8	3.5	0.4	1.9	19
MC30EUM-2	8	3.5	1.8	5.4	19
MC30EUM-3	8	3.5	5	15	19
MC75EUM-1	10	9	0.3	1.1	19
MC75EUM-2	10	9	0.9	4.8	19
MC75EUM-3	10	9	2.7	36.2	19
MC75EUM-4	10	9	25	72	19
MC150EUM	12	20	0.9	10	21
MC150EUMH	12	20	8.6	86	21
MC150EUMH2	12	20	70.0	200	21
MC150EUMH3	12	20	181.0	408	21
MC225EUM	12	41	2.3	25	21
MC225EUMH	12	41	23.0	230	21
MC225EUMH2	12	41	180.0	910	21
MC225EUMH3	12	41	816.0	1,814	21
MC600EUM	25	136	9.0	136	21
MC600EUMH	25	136	113.0	1,130	21
MC600EUMH2	25	136	400.0	2,300	21
MC600EUMH3	25	136	2,177.0	4,536	21
SC25EUM-5	8	10	1	5	31
SC25EUM-6	8	10	4	44	31
SC25EUM-7	8	10	42	500	31
SC75EUM-5	10	16	1	8	31
SC75EUM-6	10	16	7	78	31
SC75EUM-7	10	16	75	800	31
SC190EUM-5	12	31	2	16	31
SC190EUM-6	12	31	13	140	31
SC190EUM-7	12	31	136	1,550	31
SC300EUM-5	15	73	11	45	33
SC300EUM-6	15	73	34	136	33
SC300EUM-7	15	73	91	181	33
SC300EUM-8	15	73	135	680	33
SC300EUM-9	15	73	320	1,950	33
SC650EUM-5	23	210	23	113	33
SC650EUM-6	23	210	90	360	33
SC650EUM-7	23	210	320	1,090	33
SC650EUM-8	23	210	770	2,630	33
SC650EUM-9	23	210	1,800	6,350	33
MC3325EUM-0	23.2	170	3	11	53
MC3325EUM-1	23.2	170	9	40	53
MC3325EUM-2	23.2	170	30	120	53
MC3325EUM-3	23.2	170	100	420	53
MC3325EUM-4	23.2	170	350	1,420	53
MC3350EUM-0	48.6	330	5	22	53
MC3350EUM-1	48.6	330	18	70	53
MC3350EUM-2	48.6	330	60	250	53
MC3350EUM-3	48.6	330	210	840	53
MC3350EUM-4	48.6	330	710	2,830	53
MC4525EUM-0	23.1	370	7	27	54
MC4525EUM-1	23.1	370	20	90	54
MC4525EUM-2	23.1	370	80	310	54
MC4525EUM-3	23.1	370	260	1,050	54
MC4525EUM-4	23.1	370	890	3,540	54
MC4550EUM-0	48.5	740	13	54	54
MC4550EUM-1	48.5	740	45	180	54
MC4550EUM-2	48.5	740	150	620	54
MC4550EUM-3	48.5	740	520	2,090	54
MC4550EUM-4	48.5	740	1,800	7,100	54
MC4575EUM-0	73.9	1,130	20	80	54
MC4575EUM-1	73.9	1,130	70	270	54
MC4575EUM-2	73.9	1,130	230	930	54
MC4575EUM-3	73.9	1,130	790	3,140	54

Self-Compensating Shock Absorbers

TYPES	Stroke mm	Energy capacity Nm/cycle	Effective Weight		Page
			me min. kg	me max. kg	
MC4575EUM-4	73.9	1,130	2,650	10,600	54
MC6450EUM-0	48.6	1,870	35	140	55
MC6450EUM-1	48.6	1,870	140	540	55
MC6450EUM-2	48.6	1,870	460	1,850	55
MC6450EUM-3	48.6	1,870	1,600	6,300	55
MC6450EUM-4	48.6	1,870	5,300	21,200	55
MC64100EUM-0	99.4	3,730	70	280	55
MC64100EUM-1	99.4	3,730	270	1,100	55
MC64100EUM-2	99.4	3,730	930	3,700	55
MC64100EUM-3	99.4	3,730	3,150	12,600	55
MC64100EUM-4	99.4	3,730	10,600	42,500	55
MC64150EUM-0	150	5,650	100	460	55
MC64150EUM-1	150	5,650	410	1,640	55
MC64150EUM-2	150	5,650	1,390	5,600	55
MC64150EUM-3	150	5,650	4,700	18,800	55
MC64150EUM-4	150	5,650	16,000	63,700	55
SC3325EUM-5	23.2	155	1,360	2,721	69
SC3325EUM-6	23.2	155	2,500	5,443	69
SC3325EUM-7	23.2	155	4,989	8,935	69
SC3325EUM-8	23.2	155	8,618	13,607	69
SC3350EUM-5	48.6	310	2,721	4,990	69
SC3350EUM-6	48.6	310	4,536	9,980	69
SC4525EUM-5	23.1	340	3,400	6,800	69
SC4525EUM-6	23.1	340	6,350	13,600	69
SC4525EUM-7	23.1	340	12,700	22,679	69
SC4525EUM-8	23.1	340	20,411	39,000	69
SC4550EUM-5	48.5	680	6,800	12,246	69
SC4550EUM-6	48.5	680	11,790	26,988	69
SC4550EUM-7	48.5	680	25,854	44,225	69
CA2X2EU-1	50	3,600	700	2,200	83
CA2X2EU-2	50	3,600	1,800	5,400	83
CA2X2EU-3	50	3,600	4,500	13,000	83
CA2X2EU-4	50	3,600	11,300	34,000	83
CA2X4EU-1	102	7,200	1,400	4,400	83
CA2X4EU-2	102	7,200	3,600	11,000	83
CA2X4EU-3	102	7,200	9,100	27,200	83
CA2X4EU-4	102	7,200	22,600	68,000	83
CA2X6EU-1	152	10,800	2,200	6,500	83
CA2X6EU-2	152	10,800	5,400	16,300	83
CA2X6EU-3	152	10,800	13,600	40,800	83
CA2X6EU-4	152	10,800	34,000	102,000	83
CA2X8EU-1	203	14,500	2,900	8,700	83
CA2X8EU-2	203	14,500	7,200	21,700	83
CA2X8EU-3	203	14,500	18,100	54,400	83
CA2X8EU-4	203	14,500	45,300	136,000	83
CA2X10EU-1	254	18,000	3,600	11,000	83
CA2X10EU-2	254	18,000	9,100	27,200	83
CA2X10EU-3	254	18,000	22,600	68,000	83
CA2X10EU-4	254	18,000	56,600	170,000	83
CA3X5EU-1	127	14,125	2,900	8,700	84
CA3X5EU-2	127	14,125	7,250	21,700	84
CA3X5EU-3	127	14,125	18,100	54,350	84
CA3X5EU-4	127	14,125	45,300	135,900	84
CA3X8EU-1	203	22,600	4,650	13,900	84
CA3X8EU-2	203	22,600	11,600	34,800	84
CA3X8EU-3	203	22,600	29,000	87,000	84
CA3X8EU-4	203	22,600	72,500	217,000	84
CA3X12EU-1	305	33,900	6,950	20,900	84
CA3X12EU-2	305	33,900	17,400	52,200	84
CA3X12EU-3	305	33,900	43,500	130,450	84
CA3X12EU-4	305	33,900	108,700	326,000	84
CA4X6EU-3	152	47,500	3,500	8,600	85
CA4X6EU-5	152	47,500	8,600	18,600	85
CA4X6EU-7	152	47,500	18,600	42,700	85
CA4X8EU-3	203	63,300	5,000	11,400	85
CA4X8EU-5	203	63,300	11,400	25,000	85
CA4X8EU-7	203	63,300	25,000	57,000	85
CA4X16EU-3	406	126,500	10,000	23,000	85
CA4X16EU-5	406	126,500	23,000	50,000	85
CA4X16EU-7	406	126,500	50,000	115,000	85

Shock Absorbers soft contact and self-compensating

TYPES	Stroke mm	Energy capacity Nm/cycle	Effective Weight				Page
			Soft-Contact		Self-Compensating		
			me min. kg	me max. kg	me min. kg	me max. kg	
SC190EUM-0	16	25	-	-	0.7	4	29
SC190EUM-1	16	25	2.3	6	1.4	7	29
SC190EUM-2	16	25	5.5	16	3.6	18	29
SC190EUM-3	16	25	14	41	9.0	45	29
SC190EUM-4	16	25	34	91	23.0	102	29
SC300EUM-0	19	33	-	-	0.7	4	29
SC300EUM-1	19	33	2.3	7	1.4	8	29
SC300EUM-2	19	33	7	23	4.5	27	29
SC300EUM-3	19	33	23	68	14.0	82	29
SC300EUM-4	19	33	68	181	32.0	204	29
SC650EUM-0	25.4	73	-	-	2.3	14	29
SC650EUM-1	25.4	73	11	36	8.0	45	29
SC650EUM-2	25.4	73	34	113	23.0	136	29
SC650EUM-3	25.4	73	109	363	68.0	408	29
SC650EUM-4	25.4	73	363	1,089	204.0	1,180	29
SC925EUM-0	40	110	8	25	4.5	29	29
SC925EUM-1	40	110	22	72	14.0	90	29
SC925EUM-2	40	110	59	208	40.0	227	29
SC925EUM-3	40	110	181	612	113.0	726	29
SC925EUM-4	40	110	544	1,952	340.0	2,088	29

Adjustable Shock Absorbers

TYPES	Stroke mm	Max. Energy Capacity		Effective Weight		Page
		W ₃ Nm/cycle	W ₄ Nm/h	me min. kg	me max. kg	
		MA30EUM	8	3.5	5,650	
MA50EUM-B	7.2	5.5	13,550	4.50	20	35
MA35EUM	10.2	4.0	6,000	6.00	57	35
MA150EUM	12.7	22.0	35,000	1.00	109	35
MA225EUM	19	25.0	45,000	2.30	226	35
MA600EUM	25	68.0	68,000	9.00	1,360	35
MA900EUM	40	100.0	90,000	14.00	2,040	35
ML3325EUM	23.2	170	75,000	9	1,700	71
ML3325EUM	23.2	170	75,000	300	50,000	71
ML3350EUM	48.6	340	85,000	13	2,500	71
ML3350EUM	48.6	340	85,000	500	80,000	71
MA4525EUM	23.1	425	107,000	40	10,000	72
ML4525EUM	23.1	425	107,000	3,000	110,000	72
MA4550EUM	48.5	850	112,000	70	14,500	72
ML4550EUM	48.5	850	112,000	5,000	180,000	72
MA4575EUM	73.9	1,300	146,000	70	15,000	72
ML6425EUM	23.2	1,135	124,000	7,000	300,000	73
MA6450EUM	48.6	2,275	146,000	220	50,000	73
ML6450EUM	48.6	2,275	146,000	11,000	500,000	73
MA64100EUM	99.4	4,520	192,000	270	52,000	73
MA64150EUM	150	6,780	248,000	330	80,000	73
A1½X2EU	50	2,350	362,000	195	32,000	87
A1½X3½EU	89	4,150	633,000	218	36,000	87
A1½X5EU	127	5,900	904,000	227	41,000	87
A1½X6½EU	165	7,700	1,180,000	308	45,000	87
A2X2EU	50	3,600	1,100,000	250	77,000	88
A2X4EU	102	9,000	1,350,000	250	82,000	88
A2X6EU	152	13,500	1,600,000	260	86,000	88
A2X8EU	203	19,200	1,900,000	260	90,000	88
A2X10EU	254	23,700	2,200,000	320	113,000	88
A3X5EU	127	15,800	2,260,000	480	154,000	89
A3X8EU	203	28,200	3,600,000	540	181,500	89
A3X12EU	305	44,000	5,400,000	610	204,000	89

Miniature Shock Absorbers

Tuning for almost any design

Miniature shock absorbers from ACE are tried-and-tested quality products used in millions of industrial construction designs throughout the world. They optimise machines in an equally reliable and effective way by decelerating loads quickly and without recoil.

The compact, maintenance-free, hydraulic machine elements can be easily and quickly integrated in any construction design and certain models can be directly integrated in pneumatic cylinders. They reduce the load on handling devices, rotary and pivoting actuators, linear cylinders and many other industrial applications and increase their efficiency. Innovative ACE sealing techniques and shock absorber bodies and inner pressure chambers, fully machined from solid high tensile alloy, tube-shaped steel, ensure a long service life.

Easy, inexpensive constructions

Large variety of models for every purpose

Less stress on the machine

Reduced operating costs

Maintenance-free



Miniature Shock Absorbers



MC5 to MC75

Page 18

Self-Compensating

Shock absorbers in miniature format

Miniature slides, Pneumatic cylinders, Handling modules, Copiers



MC150 to MC600

Page 20

Self-Compensating, Rolling Diaphragm Technology

Exceptionally high endurance and with the lowest resetting force

Linear slides, Pneumatic cylinders, Swivel units, Handling modules



MC150-V4A to MC600-V4A

Page 22

Self-Compensating, Stainless Steel, Rolling Diaphragm Technology

Exceptionally high endurance with stainless steel corrosion protection

Clean room areas, Pharmaceutical industry, Medical technology, Food industry



PMCN150 to PMCN600

Page 24

Self-Compensating, Rolling Diaphragm Technology, TPU Bellow

Reliable protection against fluids

Finishing and processing centres, Clean room areas, Pharmaceutical industry, Medical technology



PMCN150-V4A to PMCN600-V4A

Page 26

Self-Compensating, Rolling Diaphragm Technology, TPU Bellow

Optimum corrosion protection

Finishing and processing centres, Clean room areas, Pharmaceutical industry, Medical technology



SC190 to SC925

Page 28

Self-Compensating, Soft-Contact

Long stroke and soft impact

Linear slides, Pneumatic cylinders, Handling modules, Machines and plants



SC²25 to SC²190

Page 30

Self-Compensating, Piston Tube Technology

Piston tube design for maximum energy absorption

Linear slides, Pneumatic cylinders, Swivel units, Handling modules



SC²300 to SC²650

Page 32

Self-Compensating, Piston Tube Technology

Piston tube design for maximum energy absorption

Turntables, Swivel units, Robot arms, Linear slides



MA30 to MA900

Page 34

Adjustable

Stepless adjustment

Linear slides, Pneumatic cylinders, Swivel units, Handling modules

MC5 to MC75

Shock absorbers in miniature format

Self-Compensating

Energy capacity 0.68 Nm/Cycle to 9 Nm/Cycle

Stroke 4 mm to 10 mm

Ideal for compact, efficient designs: The MC5 to MC75 series impresses users with their reduced dimensions and their very short overall lengths and low resetting forces after braking.

The outer body of each damper, produced from one solid piece, are filled with temperature stable oil, offer a continuous thread incl. a supplied lock nut and also have an integrated positive stop. These hydraulic machine elements from ACE, are ready for immediate installation and are maintenance-free. A comprehensive range of energy absorption with a wide range of effective weight potential are further benefits in these miniature units.

These miniature shock absorbers are perfectly suited to use in applications such as mechanical engineering, medical and electro-technology and robotics.

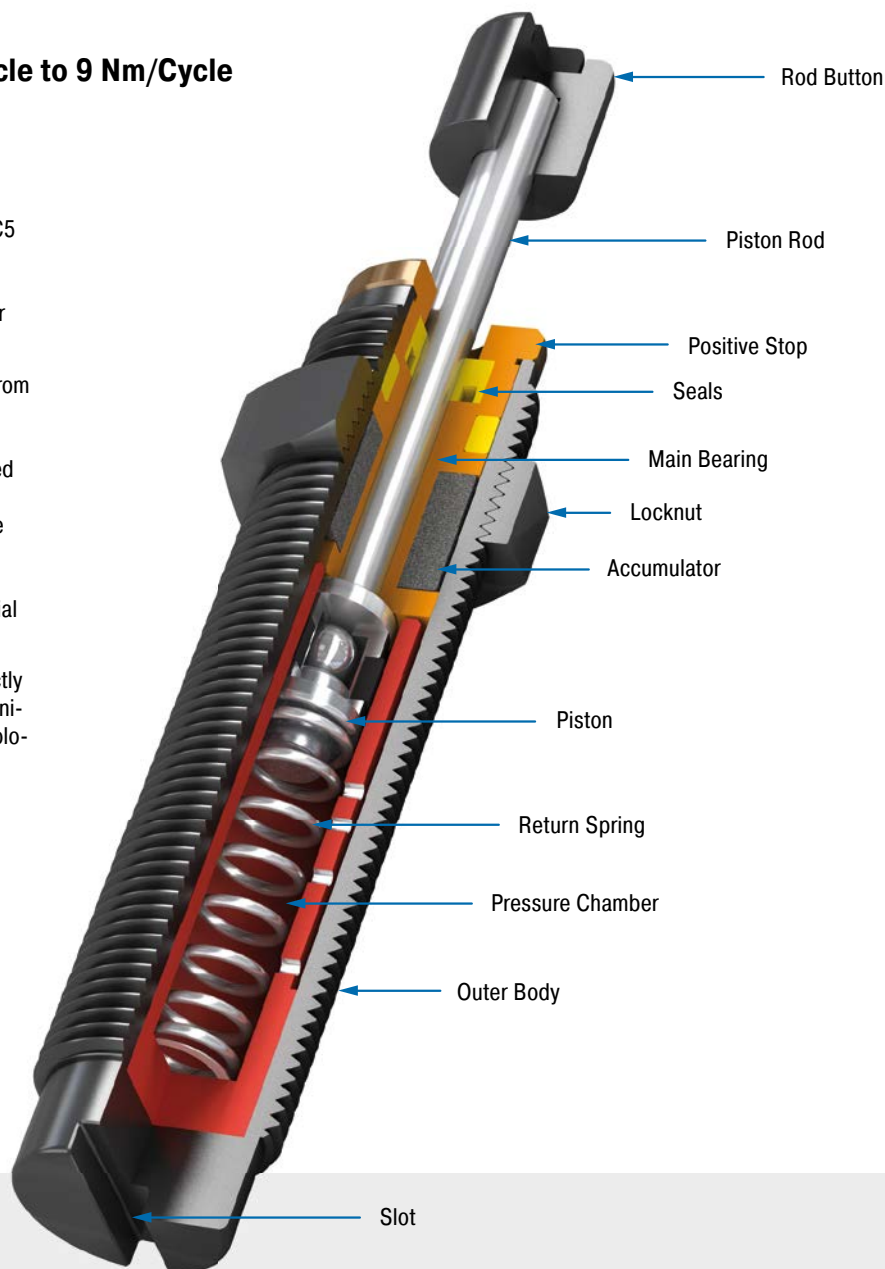

Technical Data

Energy capacity: 0.68 Nm/Cycle to 9 Nm/Cycle

Impact velocity range: 0.15 m/s to 4 m/s

Operating temperature range: -10 °C to +66 °C

Mounting: In any position

Positive stop: Integrated

Material: Outer body, Accessories: Steel corrosion-resistant coating; Piston rod: hardened stainless steel; Rod end button: Steel, MC25 and MC75: Elastomer Insert; Locknut: Steel, MC5 and MC9: Aluminium

Damping medium: Oil, temperature stable

Application field: Miniature slides, Pneumatic cylinders, Handling modules, Copiers, Measuring tables, Machines and plants, Locking systems

Note: If precise end position datum is required consider use of the stop collar type AH.

Safety instructions: External materials in the surrounding area can attack the seal components and lead to a shorter service life. Please contact ACE for appropriate solution suggestions. Do not paint the shock absorbers due to heat emission.

On request: Increased corrosion protection. Special finishes. Models without rod end button also available on request.

Self-Compensating

MC5EUM

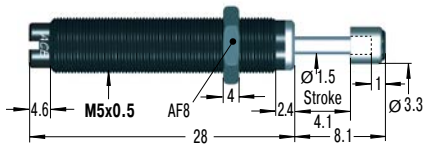

MB5SC2 Mounting Block

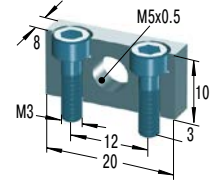

MC9EUM

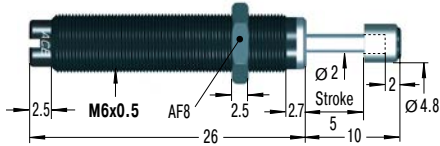

RF6 Rectangular Flange

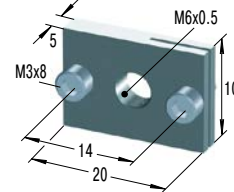

MB6SC2 Mounting Block

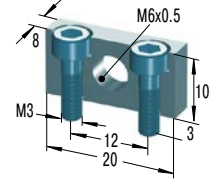

MC30EUM for use on new installations

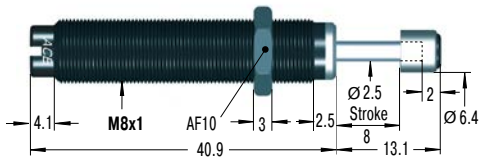

MC10EUM still available in future

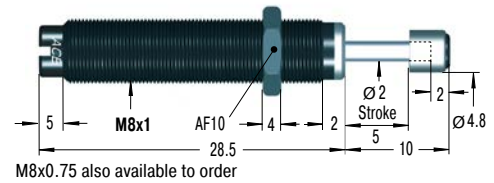

MC25EUM

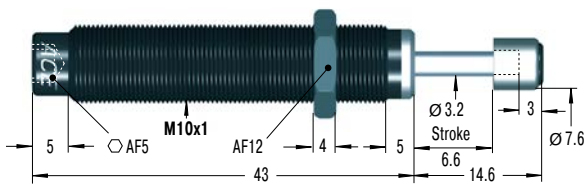

RF10 Rectangular Flange

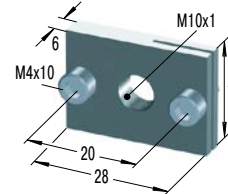

MB10SC2 Mounting Block

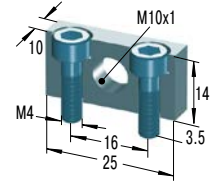

MC75EUM

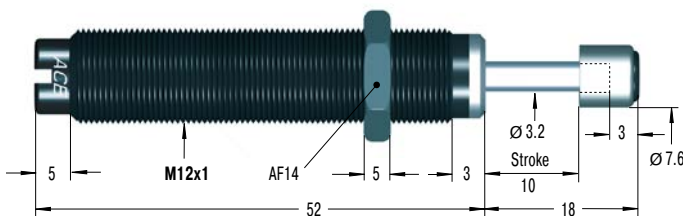

RF12 Rectangular Flange

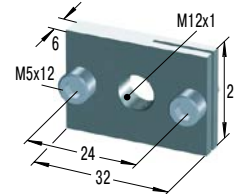

MB12 Clamp Mount

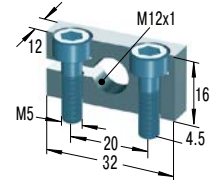

Additional accessories, mounting, installation ... see from page 36.

Performance

TYPES	Max. Energy Capacity		Effective Weight		Return Force min.	Return Force max.	Return Time s	Side Load Angle max. °	Weight kg
	W ₃ Nm/cycle	W ₄ Nm/h	me min. kg	me max. kg					
MC5EUM-1-B	0.68	2,040	0.5	4.4	1	5	0.2	2	0.003
MC5EUM-2-B	0.68	2,040	3.8	10.8	1	5	0.2	2	0.003
MC5EUM-3-B	0.68	2,040	9.7	18.7	1	5	0.2	2	0.003
MC9EUM-1-B	1	2,000	0.6	3.2	2	4	0.3	2	0.004
MC9EUM-2-B	1	2,000	0.8	4.1	2	4	0.3	2	0.004
MC10EUM-L-B	1.25	4,000	0.3	2.7	2	4	0.6	3	0.007
MC10EUM-H-B	1.25	4,000	0.7	5	2	4	0.6	3	0.007
MC25EUM-L	2.8	22,600	0.7	2.2	3	6	0.3	2	0.020
MC25EUM	2.8	22,600	1.8	5.4	3	6	0.3	2	0.020
MC25EUM-H	2.8	22,600	4.6	13.6	3	6	0.3	2	0.020
MC30EUM-1	3.5	5,600	0.4	1.9	2	6	0.3	2	0.010
MC30EUM-2	3.5	5,600	1.8	5.4	2	6	0.3	2	0.010
MC30EUM-3	3.5	5,600	5	15	2	6	0.3	2	0.010
MC75EUM-1	9	28,200	0.3	1.1	4	9	0.3	2	0.035
MC75EUM-2	9	28,200	0.9	4.8	4	9	0.3	2	0.035
MC75EUM-3	9	28,200	2.7	36.2	4	9	0.3	2	0.035
MC75EUM-4	9	28,200	25	72	4	9	0.3	2	0.035

¹ For applications with higher side load angles consider using the side load adaptor (BV) pages 38 to 45.

MC150 to MC600

Exceptionally high endurance and with the lowest resetting force

Self-Compensating, Rolling Diaphragm Technology

Energy capacity 20 Nm/Cycle to 136 Nm/Cycle

Stroke 12 mm bis 25 mm

Tried-and-tested and durable: Due to a hermetically sealed rolling diaphragm in each absorber, the MC150 to MC600 product family is suitable for an exceptional high lifetime of use with up to 25 million cycles. The rolling diaphragm technology perfected by ACE ensures complete separation of the damping fluid from the surrounding air. This makes direct installation in a pressure chamber e.g. as end stop damping in pneumatic cylinders up to approx. 7 bar possible.

The rolling diaphragm also benefits the very low return forces of these maintenance-free, ready-to-install absorbers. Progressive energy capacities, with a wide range of effective weight potential make these miniature shock absorbers, complete with an integrated positive stop a winner. Furthermore, the use of a side load adapter allows impact angles of up to 25°.

Miniature shock absorbers capable of universal mounting even inside a cylinder and also available in stainless steel options. They are often used in mechanical and plant engineering, and a multitude of other applications.

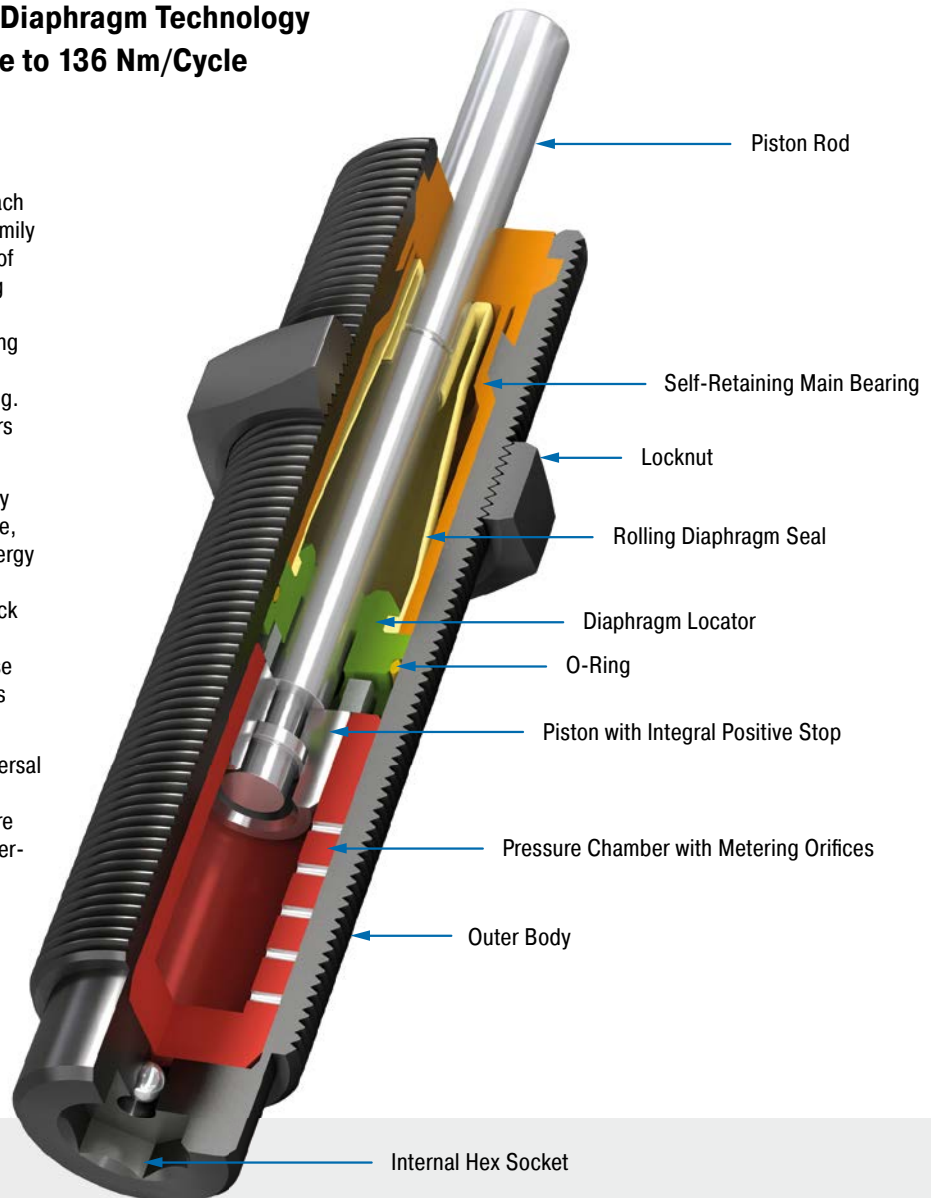

Technical Data

Energy capacity: 20 Nm/Cycle to 136 Nm/Cycle

Impact velocity range: 0.06 m/s to 6 m/s.
Other speeds on request.

Operating temperature range: 0 °C to 66 °C

Mounting: in any position

Positive stop: Integrated

Material: Outer body, Accessories: steel corrosion-resistant coating; Main bearing: plastic; Piston rod: hardened stainless steel (1.4125, AISI 440C); Rolling diaphragm: EPDM

Damping medium: oil, temperature stable

Application field: linear slides, pneumatic cylinders, swivel units, handling modules,

machines and plants, finishing and processing centres, measuring tables, tool machines, locking systems

Note: If precise end position datum is required consider use of the stop collar type AH.

Safety instructions: External materials in the surrounding area can attack the rolling seal and lead to a shorter service life. Please contact ACE for appropriate solution suggestions. Suitable for use in pressure chambers up to 7 bar.

On request: Increased corrosion protection. Special threads or other special options.

MC150EUM

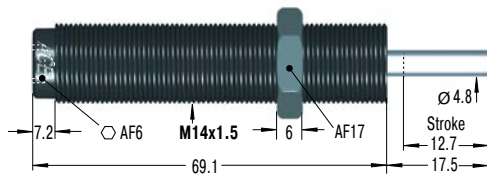

M14x1 also available to special order

PP150 Nylon Button

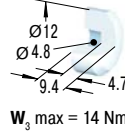

$W_3 \text{ max} = 14 \text{ Nm}$

RF14 Rectangular Flange

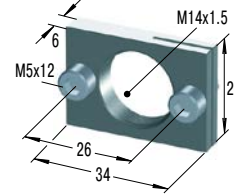

MB14 Clamp Mount

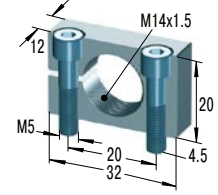

MC225EUM

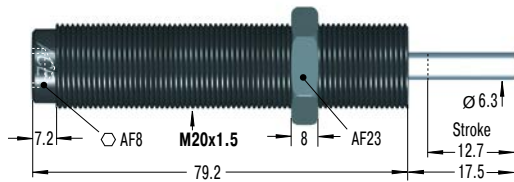

PP225 Nylon Button

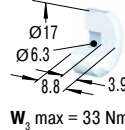

$W_3 \text{ max} = 33 \text{ Nm}$

RF20 Rectangular Flange

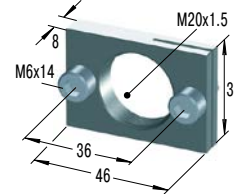

MB20 Clamp Mount

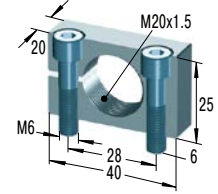

MC600EUM

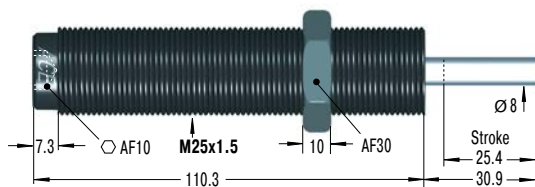

M27x3 also available to special order

PP600 Nylon Button

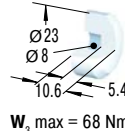

$W_3 \text{ max} = 68 \text{ Nm}$

RF25 Rectangular Flange

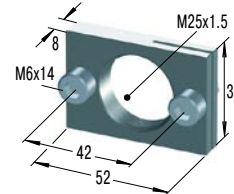

MB25 Clamp Mount

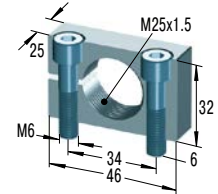

Additional accessories, mounting, installation ... see from page 36.

Performance

TYPES	Max. Energy Capacity		Effective Weight		Return Force min. N	Return Force max. N	Return Time s	Side Load Angle max. °	Weight kg
	W_3 Nm/cycle	W_4 Nm/h	me min. kg	me max. kg					
MC150EUM	20	34,000	0.9	10	3	8	0.4	4	0.06
MC150EUMH	20	34,000	8.6	86	3	8	0.4	4	0.06
MC150EUMH2	20	34,000	70.0	200	3	8	0.4	4	0.06
MC150EUMH3	20	34,000	181.0	408	3	8	1.0	4	0.06
MC225EUM	41	45,000	2.3	25	4	9	0.3	4	0.13
MC225EUMH	41	45,000	23.0	230	4	9	0.3	4	0.13
MC225EUMH2	41	45,000	180.0	910	4	9	0.3	4	0.13
MC225EUMH3	41	45,000	816.0	1,814	4	9	0.3	4	0.13
MC600EUM	136	68,000	9.0	136	5	10	0.6	2	0.31
MC600EUMH	136	68,000	113.0	1,130	5	10	0.6	2	0.31
MC600EUMH2	136	68,000	400.0	2,300	5	10	0.6	2	0.31
MC600EUMH3	136	68,000	2,177.0	4,536	5	10	0.6	2	0.31

¹ For applications with higher side load angles consider using the side load adaptor (BV) pages 38 to 45.

MC150-V4A to MC600-V4A

Exceptionally high endurance with stainless steel corrosion protection

Self-Compensating, Stainless Steel, Rolling Diaphragm Technology

Energy capacity 20 Nm/Cycle to 136 Nm/Cycle

Stroke 12 mm to 25 mm

Brilliant in every respect: These high performance miniature shock absorbers in stainless steel are based on the MC150 to MC600 product family and its proven damping technology. This means that these special absorbers offer all of the benefits of the MC standard units such as the proven ACE rolling diaphragm technology for maximum service life and direct installation in a pressure chamber with up to approx. 7 bar.

Thanks to perfectly progressive maximum energy absorption and effective weight potential, their use is augmented even further by the outer body and a complete range of accessories made of stainless steel (material 1.4404).

Miniature shock absorbers made of stainless steel are mainly used in medical and electro-technology, but also in shipbuilding, packaging and chemicals industry and in the food processing. For the latter, they are filled with a special oil in order to fulfil the authorisation conditions (NSF-H1) for this market.

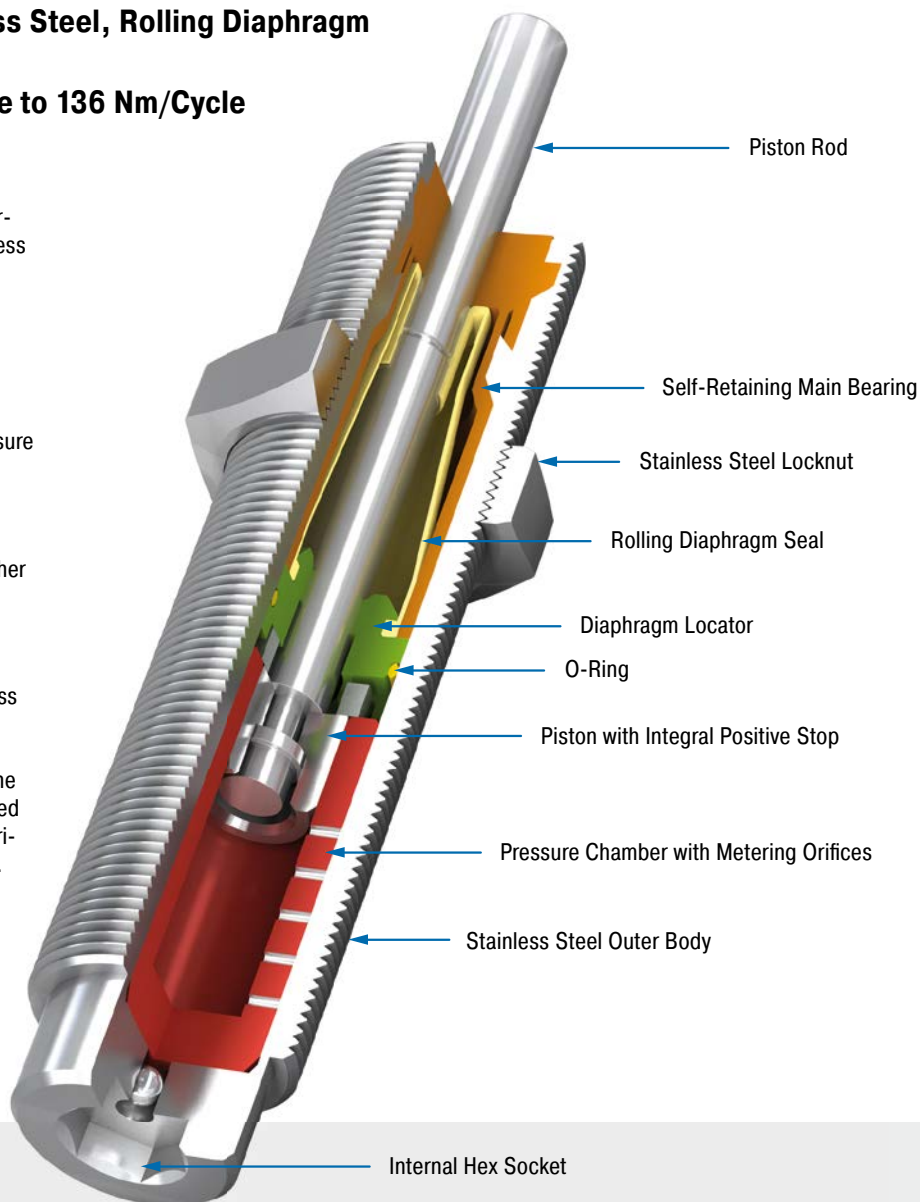

Technical Data

Energy capacity: 20 Nm/Cycle to 136 Nm/Cycle

Impact velocity range: 0.06 m/s to 6 m/s.
Other speeds on request.

Operating temperature range: 0 °C to 66 °C

Mounting: In any position

Positive stop: Integrated

Material: Outer body, Locknut, Accessories: Stainless steel (1.4404, AISI 316L); Main bearing: Plastic; Piston rod: Hardened stainless steel (1.4125, AISI 440C); Rolling diaphragm: EPDM

Damping medium: Oil, temperature stable

Application field: Clean room areas, Pharmaceutical industry, Medical technology, Food industry, Linear slides, Pneumatic cylinders, Handling modules, Machines and plants, Finishing and processing centres

Note: If precise end position datum is required consider use of the stop collar type AH.

Safety instructions: External materials in the surrounding area can attack the rolling seal and lead to a shorter service life. Please contact ACE for appropriate solution suggestions. Suitable for use in pressure chambers up to 7 bar.

On request: Special oil with food approval. Special threads or other special options available on request.

MC150EUM-V4A

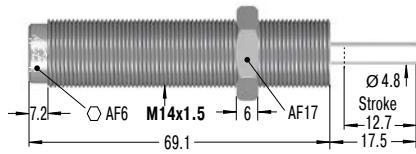

PP150 Nylon Button

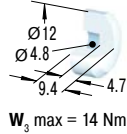

AH14-V4A Stop Collar

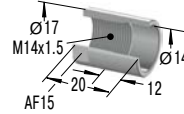

MB14SC2-V4A Mounting Block

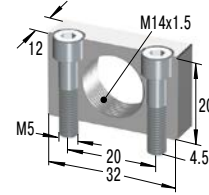

KM14-V4A Locknut

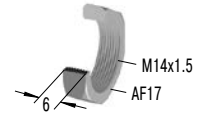

MC225EUM-V4A

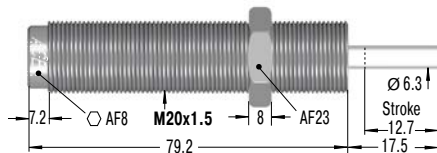

PP225 Nylon Button

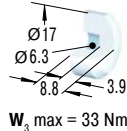

AH20-V4A Stop Collar

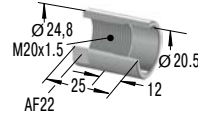

MB20SC2-V4A Mounting Block

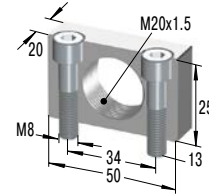

KM20-V4A Locknut



MC600EUM-V4A

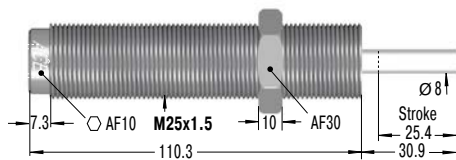

PP600 Nylon Button

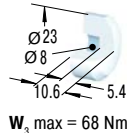

AH25-V4A Stop Collar

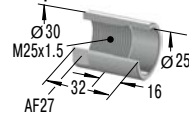

MB25SC2-V4A Mounting Block

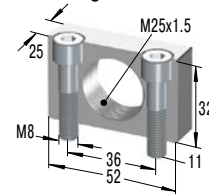

KM25-V4A Locknut

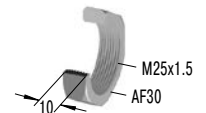

Additional accessories, mounting, installation ... see from page 36.

Performance

TYPES	Max. Energy Capacity		Effective Weight		Return Force min. N	Return Force max. N	Return Time s	Side Load Angle max. °	Weight kg
	W ₃ Nm/cycle	W ₄ Nm/h	me min. kg	me max. kg					
MC150EUM-V4A	20	34,000	0.9	10	3	5	0.4	4	0.06
MC150EUMH-V4A	20	34,000	8.6	86	3	5	0.4	4	0.06
MC150EUMH2-V4A	20	34,000	70.0	200	3	5	0.4	4	0.06
MC150EUMH3-V4A	20	34,000	181.0	408	3	5	1.0	4	0.06
MC225EUM-V4A	41	45,000	2.3	25	4	6	0.3	4	0.13
MC225EUMH-V4A	41	45,000	23.0	230	4	6	0.3	4	0.13
MC225EUMH2-V4A	41	45,000	180.0	910	4	6	0.3	4	0.13
MC225EUMH3-V4A	41	45,000	816.0	1,814	4	6	0.3	4	0.13
MC600EUM-V4A	136	68,000	9.0	136	5	9	0.6	2	0.31
MC600EUMH-V4A	136	68,000	113.0	1,130	5	9	0.6	2	0.31
MC600EUMH2-V4A	136	68,000	400.0	2,300	5	9	0.6	2	0.31
MC600EUMH3-V4A	136	68,000	2,177.0	4,536	5	9	0.6	2	0.31

¹ For applications with higher side load angles please contact ACE.

PMCN150 to PMCN600

Reliable protection against fluids

Self-Compensating, Rolling Diaphragm Technology, TPU Bellow

Energy capacity 20 Nm/Cycle to 136 Nm/Cycle
Stroke 12 mm to 25 mm

Hermetically sealed: The shock absorbers from the ACE Protection series PMCN have a compact, perfectly sealed cap as a special feature.

This protection bellows, made of TPU (thermo-plastic polyurethane), safely encapsulates the proven ACE rolling diaphragm from the outside environment. Aggressive cutting, lubricating and cleaning agents don't stand a chance and the function of the maintenance-free, ready-to-install shock absorber is retained. They are also available in full stainless steel.

The PMCN series is a good alternative to the SP type air bleed collar if no compressed air is available on the machine or system.

Reliable protection against aggressive fluids, these miniature shock absorbers are the first choice everywhere where conventional dampers wear out too quickly, eg. As in machining centers or other applications of mechanical engineering.

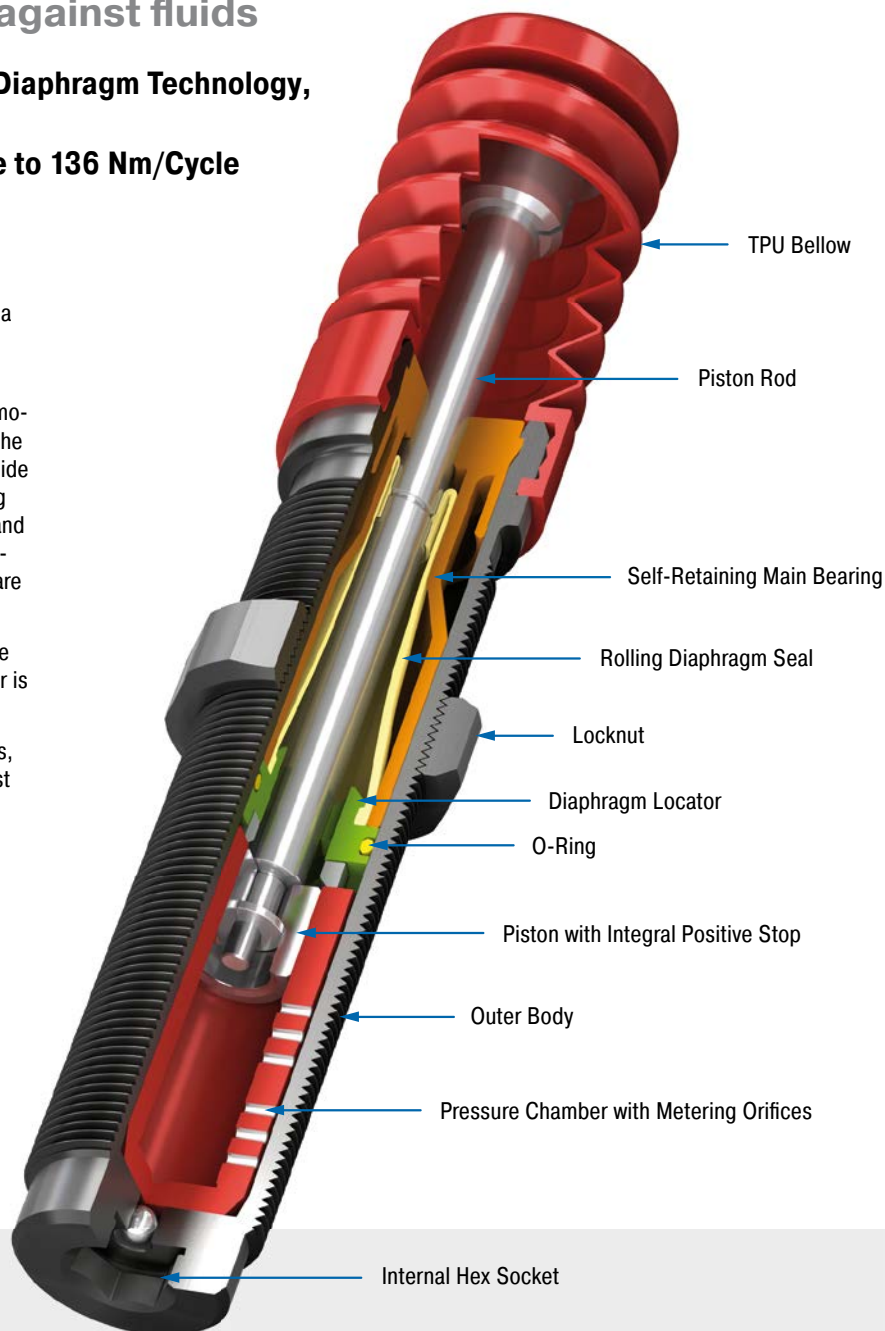

Technical Data

Energy capacity: 20 Nm/Cycle to 136 Nm/Cycle

Impact velocity range: 0.06 m/s to 6 m/s.
Other speeds on request.

Operating temperature range: 0 °C to 66 °C

Mounting: In any position

Positive stop: Integrated

Material: Outer body: Steel corrosion-resistant coating; Main bearing: Plastic; Piston rod: Hardened stainless steel (1.4125, AISI 440C); Bellow: TPU, steel insert: Stainless steel (1.4404/1.4571, AISI 316L/316Ti); Rolling diaphragm: EPDM

Damping medium: Oil, temperature stable

Application field: Finishing and processing centres, Clean room areas, Pharmaceutical industry, Medical technology, Food industry, Linear slides, Pneumatic cylinders, Machines and plants

Note: Final preliminary test must be done on the application.

Safety instructions: Do not paint the shock absorbers due to heat emission.

On request: Special accessories available on request.

PMCN150EUM

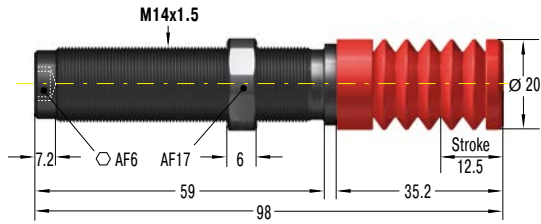

KM14 Locknut

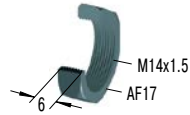

RF14 Rectangular Flange

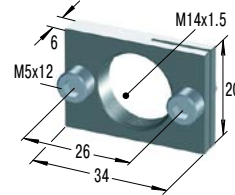

MB14 Clamp Mount

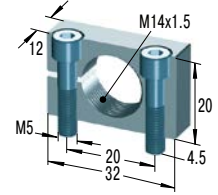

PMCN225EUM

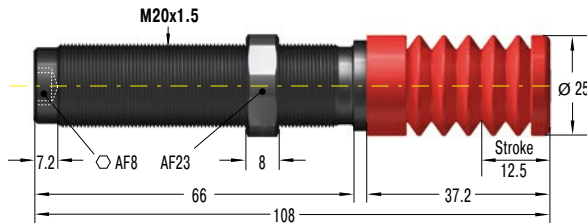

KM20 Locknut

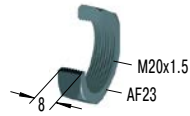

RF20 Rectangular Flange

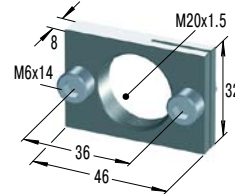

MB20 Clamp Mount

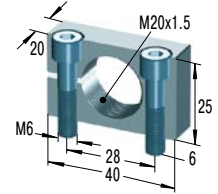

PMCN600EUM

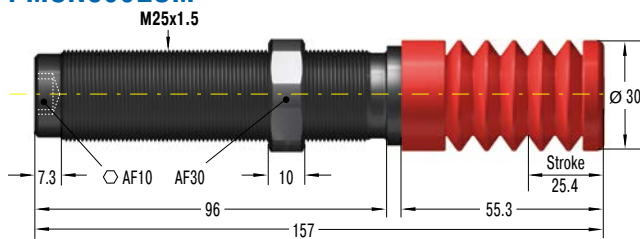

KM25 Locknut

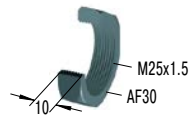

RF25 Rectangular Flange

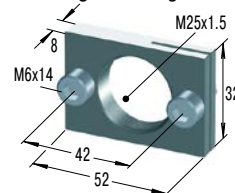

MB25 Clamp Mount

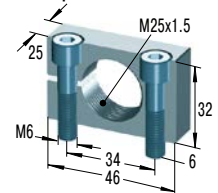

Additional accessories, mounting, installation ... see from page 36.

Performance

TYPES	Max. Energy Capacity		Effective Weight		Return Force min. N	Return Force max. N	Return Time s	Side Load Angle max. °	Weight kg
	W ₃ Nm/cycle	W ₄ Nm/h	me min. kg	me max. kg					
PMCN150EUM	20	34,000	0.9	10	8	80	0.4	4	0.07
PMCN150EUMH	20	34,000	8.6	86	8	80	0.4	4	0.07
PMCN150EUMH2	20	34,000	70.0	200	8	80	0.4	4	0.07
PMCN150EUMH3	20	34,000	181.0	408	8	80	1.0	4	0.07
PMCN225EUM	41	45,000	2.3	25	8	85	0.3	4	0.17
PMCN225EUMH	41	45,000	23	230	8	85	0.3	4	0.17
PMCN225EUMH2	41	45,000	180.0	910	8	85	0.3	4	0.17
PMCN225EUMH3	41	45,000	816.0	1,814	8	85	0.3	4	0.17
PMCN600EUM	136	68,000	9.0	136	8	90	0.6	2	0.32
PMCN600EUMH	136	68,000	113.0	1,130	8	90	0.6	2	0.32
PMCN600EUMH2	136	68,000	400	2,300	8	90	0.6	2	0.32
PMCN600EUMH3	136	68,000	2,177.0	4,536	8	90	0.6	2	0.32

PMCN150-V4A to PMCN600-V4A

Optimum corrosion protection

Self-Compensating, Rolling Diaphragm Technology, TPU Bellow

Energy capacity 20 Nm/Cycle to 136 Nm/Cycle
Stroke 12 mm to 25 mm

Hermetically sealed and rustproof: The Protection series PMCN is also available in a stainless steel design. This is of particular interest to the food and packaging industries.

Their main special feature is the compact, totally sealed bellow between the body and the cap made of TPU (thermoplastic polyurethane). This protection safely encapsulates the ACE rolling diaphragm from the outside environment. Aggressive fluids don't stand a chance.

The PMCN series is an excellent alternative if the accessory option of the SP type air bleed collar cannot be used due to a lack of compressed air.

The PMCN series miniature shock absorbers, produced from stainless steel, are primarily suitable for use in the food industry, but are also wherever an elegant look is important e.g. in shipbuilding.

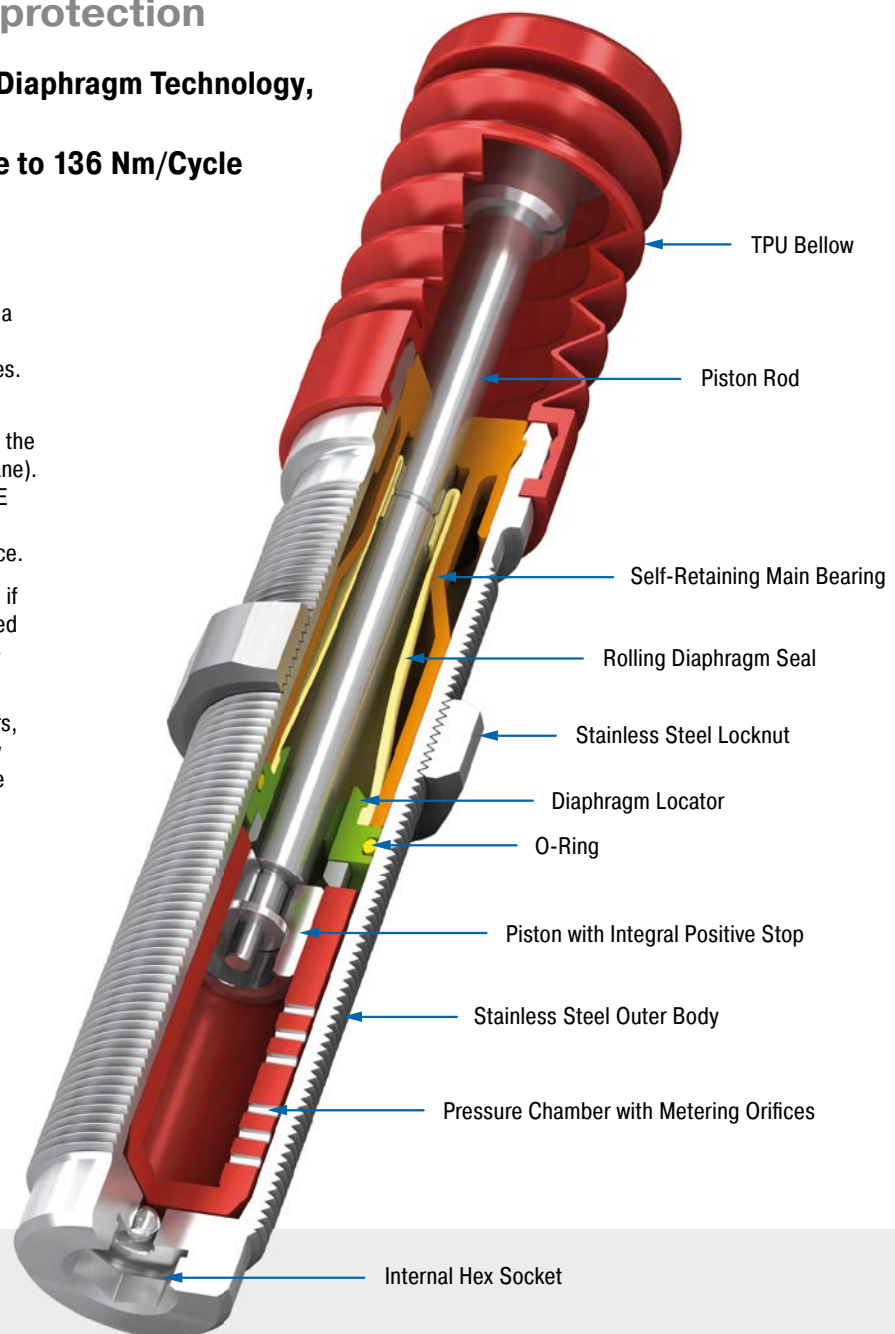

Technical Data

Energy capacity: 20 Nm/Cycle to 136 Nm/Cycle

Impact velocity range: 0.06 m/s to 6 m/s.
Other speeds on request.

Operating temperature range: 0 °C to 66 °C

Mounting: In any position

Positive stop: Integrated

Material: Outer body: Stainless steel (1.4404, AISI 316L); Main bearing: Plastic; Piston rod: Hardened stainless steel (1.4125, AISI 440C); Bellow: TPU, steel insert: Stainless steel (1.4404/1.4571, AISI 316L/316Ti); Rolling diaphragm: EPDM

Damping medium: Oil, temperature stable

Application field: Finishing and processing centres, Clean room areas, Pharmaceutical industry, Medical technology, Food industry, Machines and plants

Note: Final preliminary test must be done on the application.

Safety instructions: Do not paint the shock absorbers due to heat emission.

On request: Special accessories available on request.

PMCN150EUM-V4A

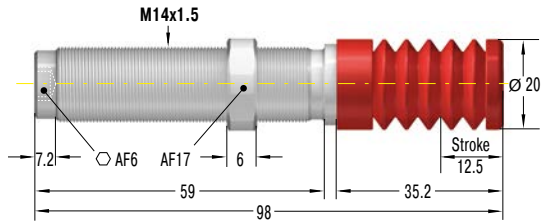

KM14-V4A

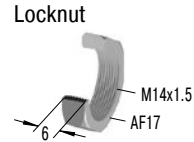

MB14SC2-V4A

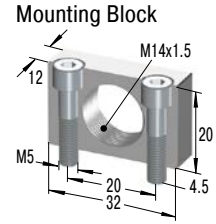

PMCN225EUM-V4A

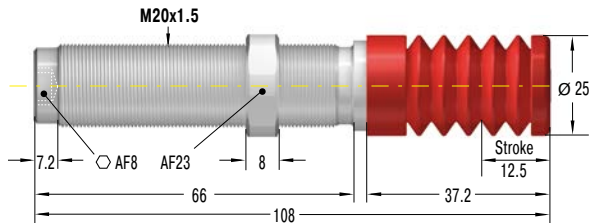

KM20-V4A

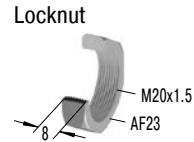

MB20SC2-V4A

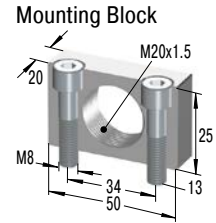

PMCN600EUM-V4A

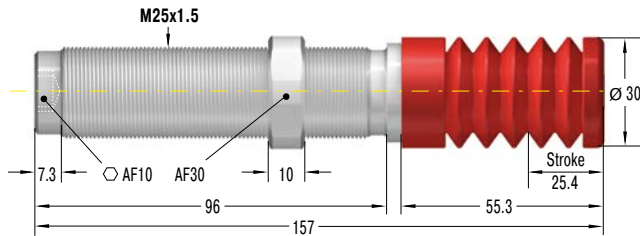

KM25-V4A

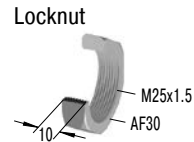

MB25SC2-V4A

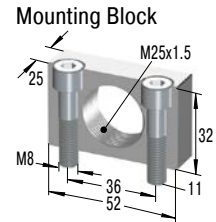

Additional accessories, mounting, installation ... see from page 36.

Performance

TYPES	Max. Energy Capacity		Effective Weight		Return Force min.	Return Force max.	Return Time s	Side Load Angle max. °	Weight kg
	W ₃ Nm/cycle	W ₄ Nm/h	me min. kg	me max. kg					
PMCN150EUM-V4A	20	34,000	0.9	10	8	80	0.4	4	0.07
PMCN150EUMH-V4A	20	34,000	8.6	86	8	80	0.4	4	0.07
PMCN150EUMH2-V4A	20	34,000	70.0	200	8	80	0.4	4	0.07
PMCN150EUMH3-V4A	20	34,000	181.0	408	8	80	1.0	4	0.07
PMCN225EUM-V4A	41	45,000	2.3	25	8	85	0.3	4	0.17
PMCN225EUMH-V4A	41	45,000	23.0	230	8	85	0.3	4	0.17
PMCN225EUMH2-V4A	41	45,000	180.0	910	8	85	0.3	4	0.17
PMCN225EUMH3-V4A	41	45,000	816.0	1,814	8	85	0.3	4	0.17
PMCN600EUM-V4A	136	68,000	9.0	136	8	90	0.6	2	0.32
PMCN600EUMH-V4A	136	68,000	113.0	1,130	8	90	0.6	2	0.32
PMCN600EUMH2-V4A	136	68,000	400.0	2,300	8	90	0.6	2	0.32
PMCN600EUMH3-V4A	136	68,000	2,177.0	4,536	8	90	0.6	2	0.32

SC190 to SC925

Long stroke and soft impact

Self-Compensating, Soft-Contact
Energy capacity 25 Nm/Cycle to 110 Nm/Cycle
Stroke 16 mm to 40 mm

Ideal for soft damping: The SC found in the model code from the ACE series SC190 to 925 stands for 'soft contact'. These miniature shock absorbers manufactured from one solid piece are designed in such a way that they can be setup with a linear or a progressive braking curve. The soft damping character is thanks to the special, long strokes producing smooth deceleration and low reaction forces.

These maintenance-free, ready-to-install hydraulic machine elements are equipped with an integrated positive stop. The use of side load adapter allows impact angles of up to 25°. Thanks to the designed overlapping effective weight ranges, these dampers cover an effective load range of below 1 kg to more than 2,000 kg!

The miniature shock absorbers from the SC190 to 925 series are used in mechanical engineering and primarily in the areas of handling and automation.

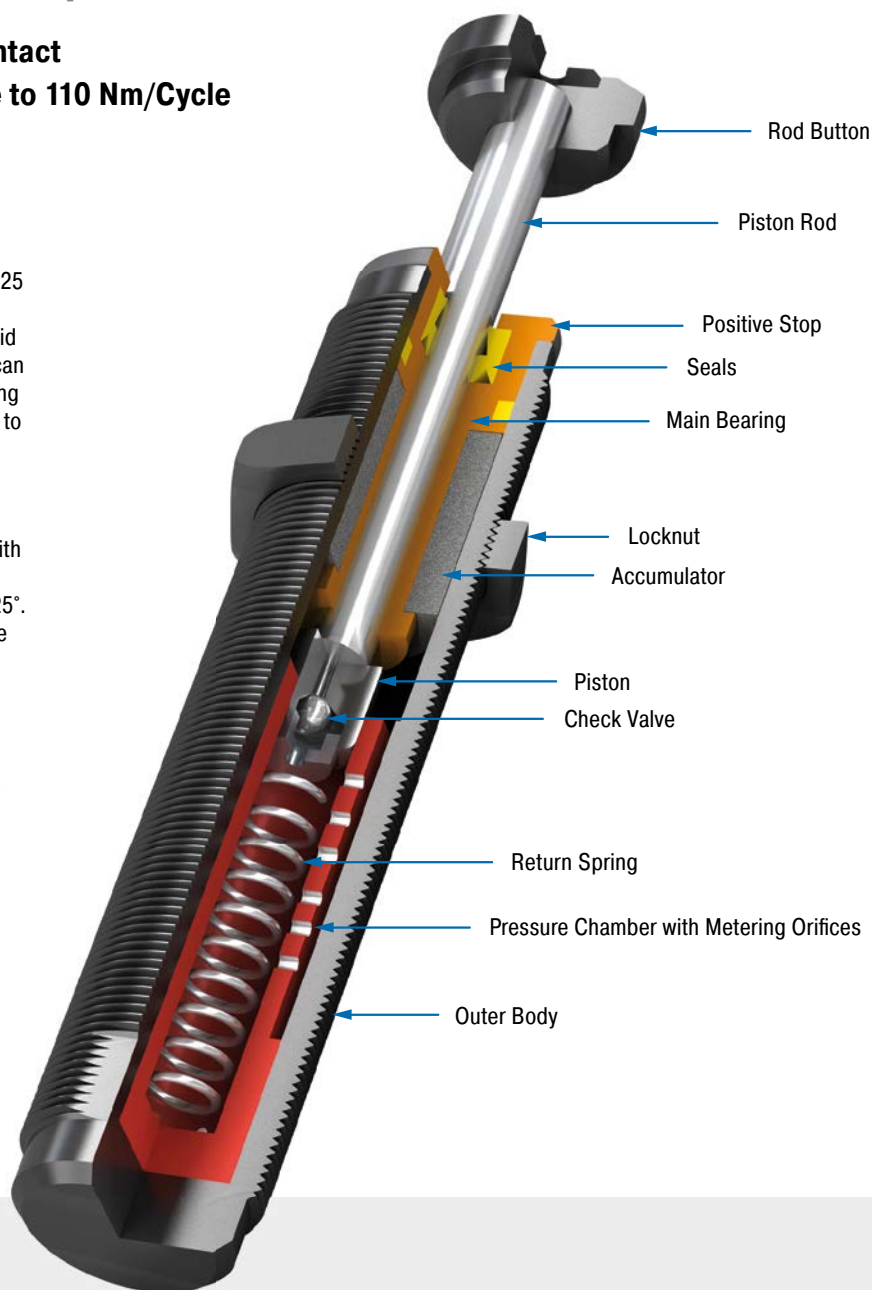

Technical Data

Energy capacity: 25 Nm/Cycle to 110 Nm/Cycle

Impact velocity range: 0.15 m/s to 3.66 m/s. Other speeds on request.

Operating temperature range: 0 °C to 66 °C

Mounting: in any position

Positive stop: Integrated

Material: Outer body, Accessories: steel corrosion-resistant coating; Piston rod: hardened stainless steel

Damping medium: oil, temperature stable

Application field: linear slides, pneumatic cylinders, handling modules, machines and

plants, finishing and processing centres, measuring tables, tool machines

Note: If precise end position datum is required consider use of the stop collar type AH.

Safety instructions: External materials in the surrounding area can attack the seal components and lead to a shorter service life. Please contact ACE for appropriate solution suggestions. Do not paint the shock absorbers due to heat emission.

On request: Nickel-plated or weartec finish (seawater resistant) or other special finishes available to special order. Models without rod end button.

SC190EUM; 0 to 4

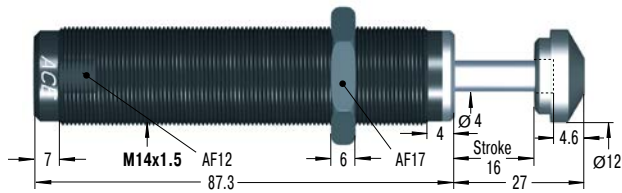

M14x1 and M16x1 also available to special order

RF14 Rectangular Flange

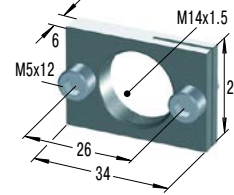

MB14 Clamp Mount

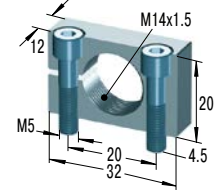

SC300EUM; 0 to 4

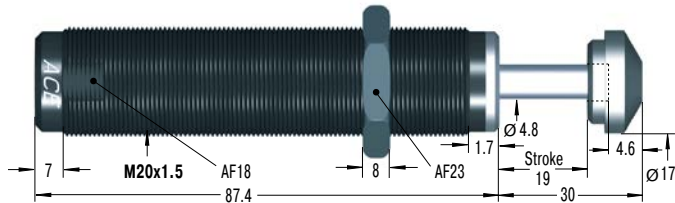

M22x1.5 also available to special order

RF20 Rectangular Flange

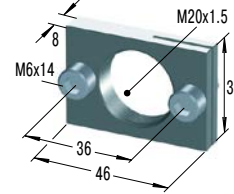

MB20 Clamp Mount

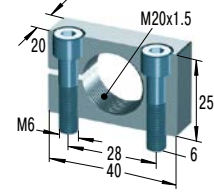

SC650EUM; 0 to 4

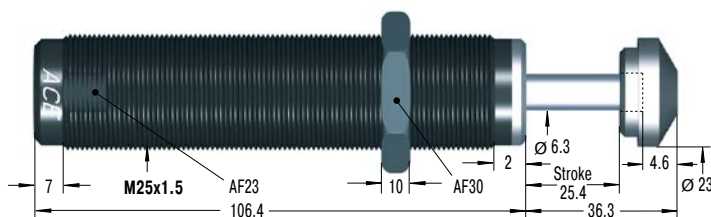

M26x1.5 also available to special order

RF25 Rectangular Flange

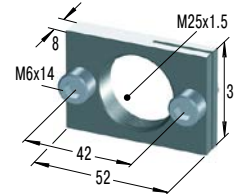

MB25 Clamp Mount

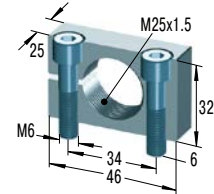

SC925EUM; 0 to 4

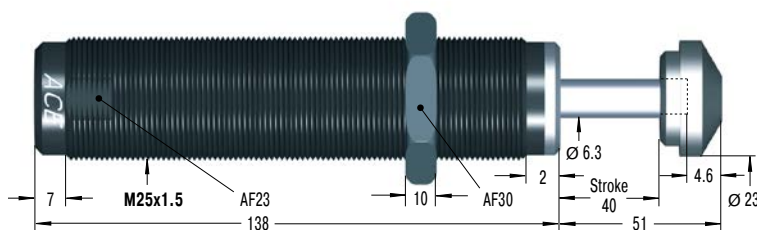

RF25 Rectangular Flange

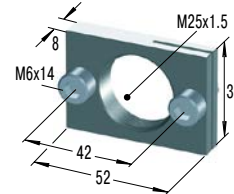

MB25 Clamp Mount

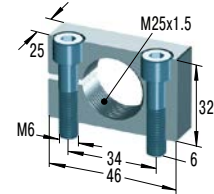

Additional accessories, mounting, installation ... see from page 36.

Performance

TYPES	Max. Energy Capacity		Effective Weight					Return Force min. N	Return Force max. N	Return Time s	1 Side Load Angle max. °	Weight kg
	W ₃ Nm/cycle	W ₄ Nm/h	Soft-Contact		Self-Compensating		Hardness					
			me min. kg	me max. kg	me min. kg	me max. kg						
SC190EUM-0	25	34,000	-	-	0.7	4	-0	4	9	0.25	5	0.08
SC190EUM-1	25	34,000	2.3	6	1.4	7	-1	4	9	0.25	5	0.08
SC190EUM-2	25	34,000	5.5	16	3.6	18	-2	4	9	0.25	5	0.08
SC190EUM-3	25	34,000	14	41	9.0	45	-3	4	9	0.25	5	0.08
SC190EUM-4	25	34,000	34	91	23.0	102	-4	4	9	0.25	5	0.08
SC300EUM-0	33	45,000	-	-	0.7	4	-0	5	10	0.10	5	0.18
SC300EUM-1	33	45,000	2.3	7	1.4	8	-1	5	10	0.10	5	0.18
SC300EUM-2	33	45,000	7	23	4.5	27	-2	5	10	0.10	5	0.18
SC300EUM-3	33	45,000	23	68	14.0	82	-3	5	10	0.10	5	0.18
SC300EUM-4	33	45,000	68	181	32.0	204	-4	5	10	0.10	5	0.18
SC650EUM-0	73	68,000	-	-	2.3	14	-0	11	32	0.20	5	0.34
SC650EUM-1	73	68,000	11	36	8.0	45	-1	11	32	0.20	5	0.34
SC650EUM-2	73	68,000	34	113	23.0	136	-2	11	32	0.20	5	0.34
SC650EUM-3	73	68,000	109	363	68.0	408	-3	11	32	0.20	5	0.34
SC650EUM-4	73	68,000	363	1,089	204.0	1,180	-4	11	32	0.20	5	0.34
SC925EUM-0	110	90,000	8	25	4.5	29	-0	11	32	0.40	5	0.42
SC925EUM-1	110	90,000	22	72	14.0	90	-1	11	32	0.40	5	0.42
SC925EUM-2	110	90,000	59	208	40.0	227	-2	11	32	0.40	5	0.42
SC925EUM-3	110	90,000	181	612	113.0	726	-3	11	32	0.40	5	0.42
SC925EUM-4	110	90,000	544	1,952	340.0	2,088	-4	11	32	0.40	5	0.42

¹ For applications with higher side load angles consider using the side load adaptor (BV) pages 38 to 45.

SC²25 to SC²190

Piston tube design for maximum energy absorption

Self-Compensating, Piston Tube Technology Energy capacity 10 Nm/Cycle to 31 Nm/Cycle Stroke 8 mm to 12 mm

Soft damping, but enormous capacity: The range of 'soft contact' absorbers SC²25 to 190 extends from thread size M10 to M14 and covers effective weight ranges of 1 kg to 1,550 kg. All models are characterised by high energy absorption and they also unite the piston tube technology with the diaphragm seal perfected by ACE. This enables direct installation as end position damping in pneumatic cylinders at 5 to 7 bar or applications where deceleration needs to take place close to the pivot point.

They are maintenance-free, have an integrated positive stop and are mountable in any position. The option of a side load adapter allows impact angles of up to 25°.

Thanks to their robust design and their durability, these miniature shock absorbers can be used for a wide range of applications. Designers mainly use them for pick and place systems, pneumatic rotary modules and in automation applications.

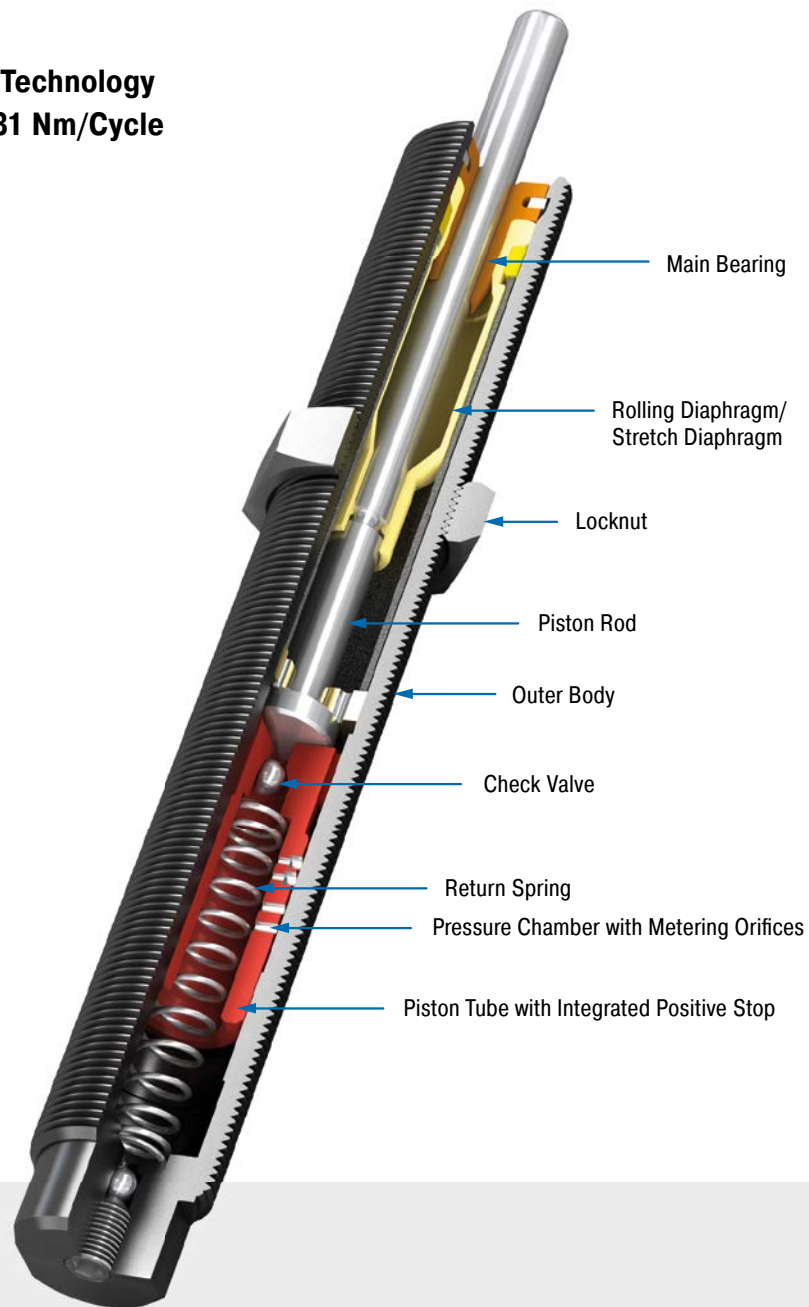

Technical Data

Energy capacity: 10 Nm/Cycle to 31 Nm/Cycle

Impact velocity range: 0.1 m/s to 5.7 m/s.
Other speeds on request.

Operating temperature range: 0 °C to 66 °C

Mounting: In any position

Positive stop: Integrated

Material: Outer body, Accessories: Steel corrosion-resistant coating; Piston rod: hardened stainless steel; Rolling diaphragm: SC²190: EPDM; Stretch diaphragm: SC²25 and SC²75: Nitrile

Damping medium: Oil, temperature stable

Application field: Linear slides, Pneumatic cylinders, Swivel units, Handling modules, Machines and plants, Finishing and processing centres, Measuring tables, Tool machines, Locking systems

Note: If precise end position datum is required consider use of the stop collar type AH.

Safety instructions: External materials in the surrounding area can attack the rolling and stretch seals and lead to a shorter service life. Please contact ACE for appropriate solution suggestions.

On request: Increased corrosion protection. Special finishes.

SC25EUM; 5 to 7

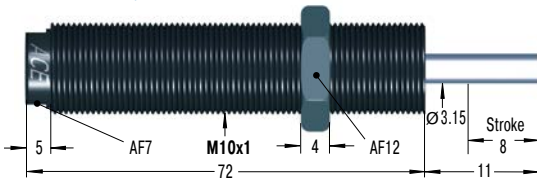

RF10 Rectangular Flange

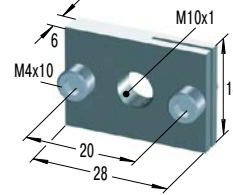

MB10SC2 Mounting Block

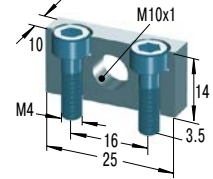

SC75EUM; 5 to 7

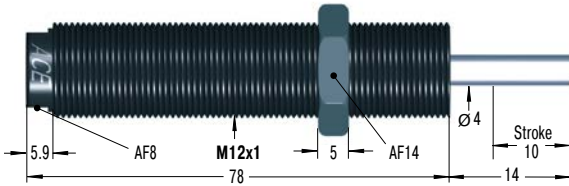

RF12 Rectangular Flange

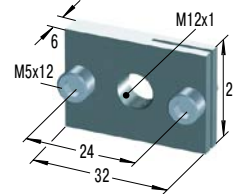

MB12SC2 Mounting Block

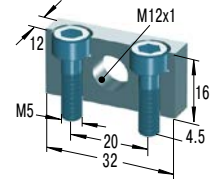

SC190EUM; 5 to 7

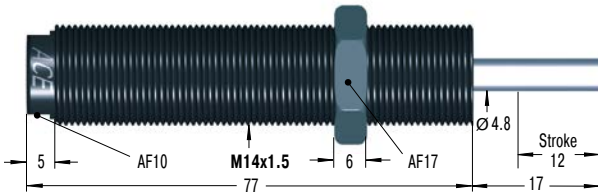

M14x1 also available to special order

RF14 Rectangular Flange

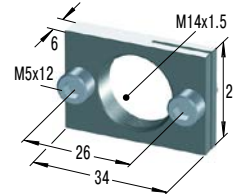

MB14SC2 Mounting Block

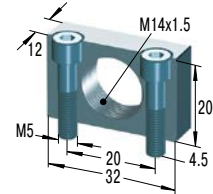

Additional accessories, mounting, installation ... see from page 36.

Performance

TYPES	Max. Energy Capacity		Effective Weight			Return Force min. N	Return Force max. N	Return Time s	Side Load Angle max. °	Weight kg
	W ₃ Nm/cycle	W ₄ Nm/h	me min. kg	me max. kg	Hardness					
SC25EUM-5	10	16,000	1	5	-5	4.5	14	0.3	2	0.029
SC25EUM-6	10	16,000	4	44	-6	4.5	14	0.3	2	0.029
SC25EUM-7	10	16,000	42	500	-7	4.5	14	0.3	2	0.029
SC75EUM-5	16	30,000	1	8	-5	6.0	19	0.3	2	0.047
SC75EUM-6	16	30,000	7	78	-6	6.0	19	0.3	2	0.047
SC75EUM-7	16	30,000	75	800	-7	6.0	19	0.3	2	0.047
SC190EUM-5	31	50,000	2	16	-5	6.0	19	0.4	2	0.055
SC190EUM-6	31	50,000	13	140	-6	6.0	19	0.4	2	0.055
SC190EUM-7	31	50,000	136	1,550	-7	6.0	19	0.4	2	0.055

¹ For applications with higher side load angles consider using the side load adaptor (BV) pages 38 to 45.

SC²300 to SC²650

Piston tube design for maximum energy absorption

Self-Compensating, Piston Tube Technology
Energy capacity 73 Nm/Cycle to 210 Nm/Cycle
Stroke 15 mm to 23 mm

Added safety with accumulator technology: The larger 'soft contact' models from the SC²300 to 650 are available with up to three times the energy absorption compared to similar sizes of standard shock absorbers SC190 to 925, due to the ACE piston tube speciality. Furthermore, the membrane accumulator serves as a compensation element for the oil displaced in the shock absorber and replaces the standard use of absorber materials. This increases process safety even further.

The absorbers, which are perfect for rotary modules for example, are available in progressively stepped effective weight ranges with an integrated positive stop. They are maintenance-free and ready for direct installation. The side load adapter option allows impact angles of up to 25°.

These miniature shock absorbers offer high performance levels with a long service life and are particularly popular for handling, mounting very close to pivots and automation tasks.

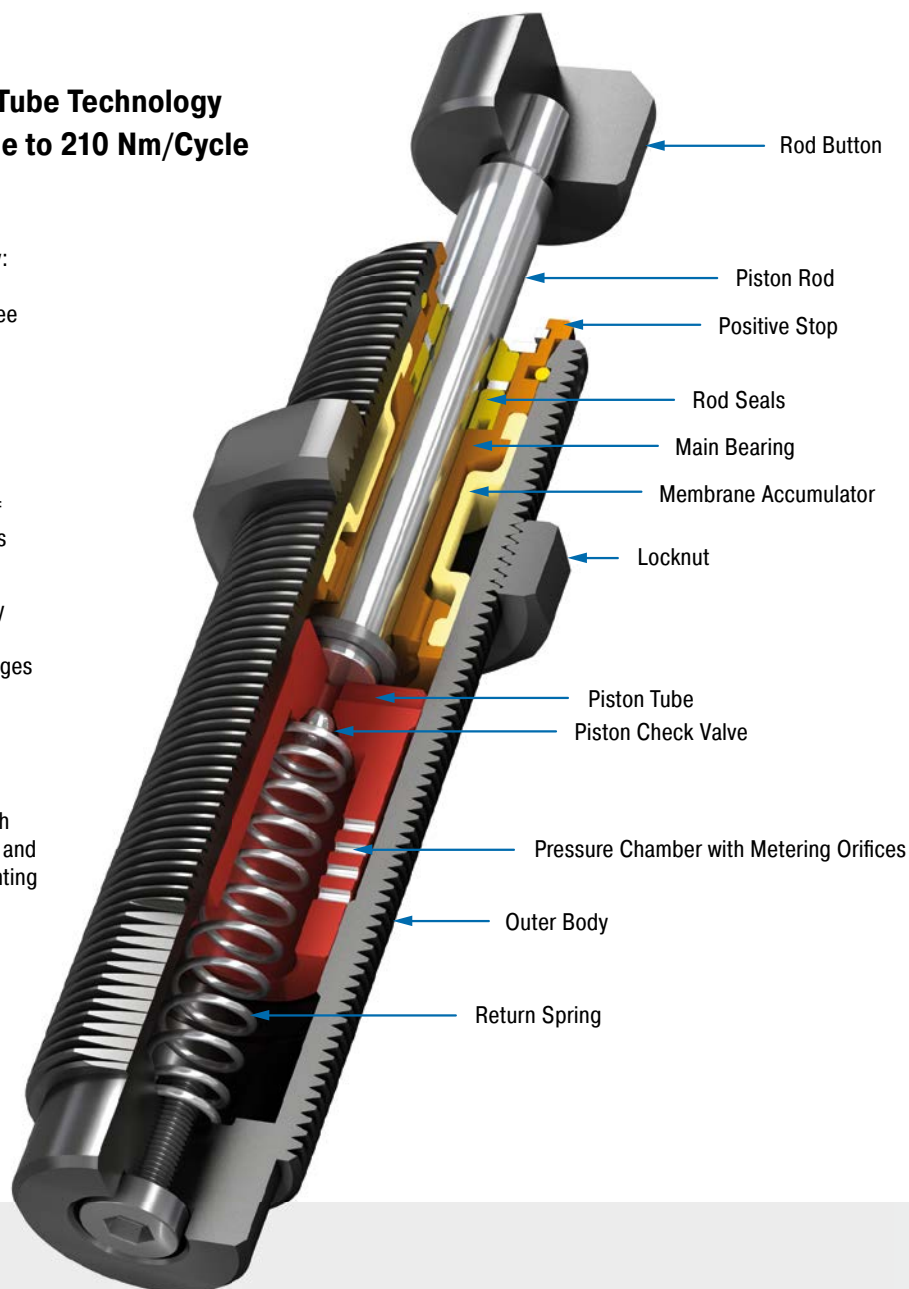

Technical Data

Energy capacity: 73 Nm/Cycle to 210 Nm/Cycle

Impact velocity range: 0.09 m/s to 3.66 m/s. Other speeds on request.

Operating temperature range: 0 °C to 66 °C

Mounting: in any position

Positive stop: Integrated

Material: Outer body: steel corrosion-resistant coating; Piston rod: hardened stainless steel; Accessories: hardened steel and corrosion-resistant coating

Damping medium: oil, temperature stable

Application field: turntables, swivel units, robot arms, linear slides, pneumatic cylinders, handling modules, machines and plants, finishing and processing centres, tool machines

Note: If precise end position datum is required consider use of the stop collar type AH.

On request: Increased corrosion protection. Special finishes.

SC300EUM; 5 to 9

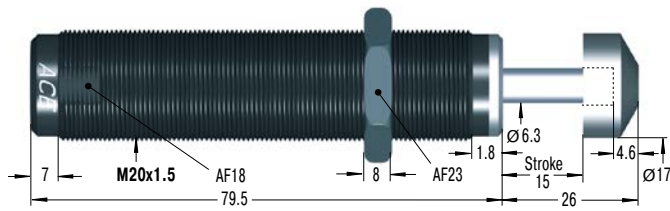

RF20 Rectangular Flange

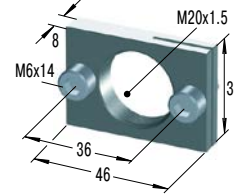

MB20SC2 Mounting Block

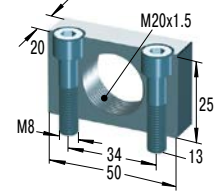

SC650EUM; 5 to 9

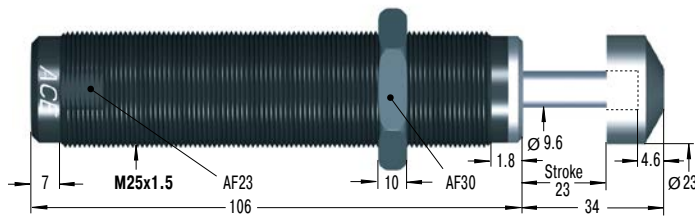

RF25 Rectangular Flange

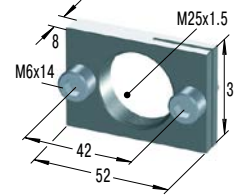

MB25SC2 Mounting Block

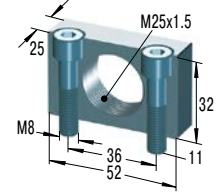

Additional accessories, mounting, installation ... see from page 36.

Performance

TYPES	Max. Energy Capacity		Effective Weight			Return Force min. N	Return Force max. N	Return Time s	Side Load Angle max. °	Weight kg
	W₃ Nm/cycle	W₄ Nm/h	me min. kg	me max. kg	Hardness					
SC300EUM-5	73	45,000	11	45	-5	8	18	0.2	5	0.150
SC300EUM-6	73	45,000	34	136	-6	8	18	0.2	5	0.150
SC300EUM-7	73	45,000	91	181	-7	8	18	0.2	5	0.150
SC300EUM-8	73	45,000	135	680	-8	8	18	0.2	5	0.150
SC300EUM-9	73	45,000	320	1,950	-9	8	18	0.2	5	0.150
SC650EUM-5	210	68,000	23	113	-5	11	33	0.3	5	0.310
SC650EUM-6	210	68,000	90	360	-6	11	33	0.3	5	0.310
SC650EUM-7	210	68,000	320	1,090	-7	11	33	0.3	5	0.310
SC650EUM-8	210	68,000	770	2,630	-8	11	33	0.3	5	0.310
SC650EUM-9	210	68,000	1,800	6,350	-9	11	33	0.3	5	0.310

¹ For applications with higher side load angles consider using the side load adaptor (BV) pages 38 to 45.

MA30 to MA900

Stepless adjustment

Adjustable

Energy capacity 3.5 Nm/Cycle to 100 Nm/Cycle

Stroke 8 mm to 40 mm

The miniature shock absorbers from the MA30 to MA900 series can be adjusted and precisely adapted to your requirements. For example, the MA150 displays the rolling diaphragm technology from the MC150 to MC600 family and offers all of the advantages of this technology, such as use in pressure chambers. Thanks to long strokes (including 40 mm on the MA900) lower reaction forces result, which provide a soft damping characteristic.

All variations of these units are maintenance-free, ready-to-install machine elements and have an integrated positive stop. They provide the best service where application data changes, where the calculation parameters are not clear or where maximum flexibility in the possible usage is required.

The adjustable miniature shock absorbers from ACE can be used to meet precisely the customer's application and are therefore found everywhere in mechanical engineering and many other applications.

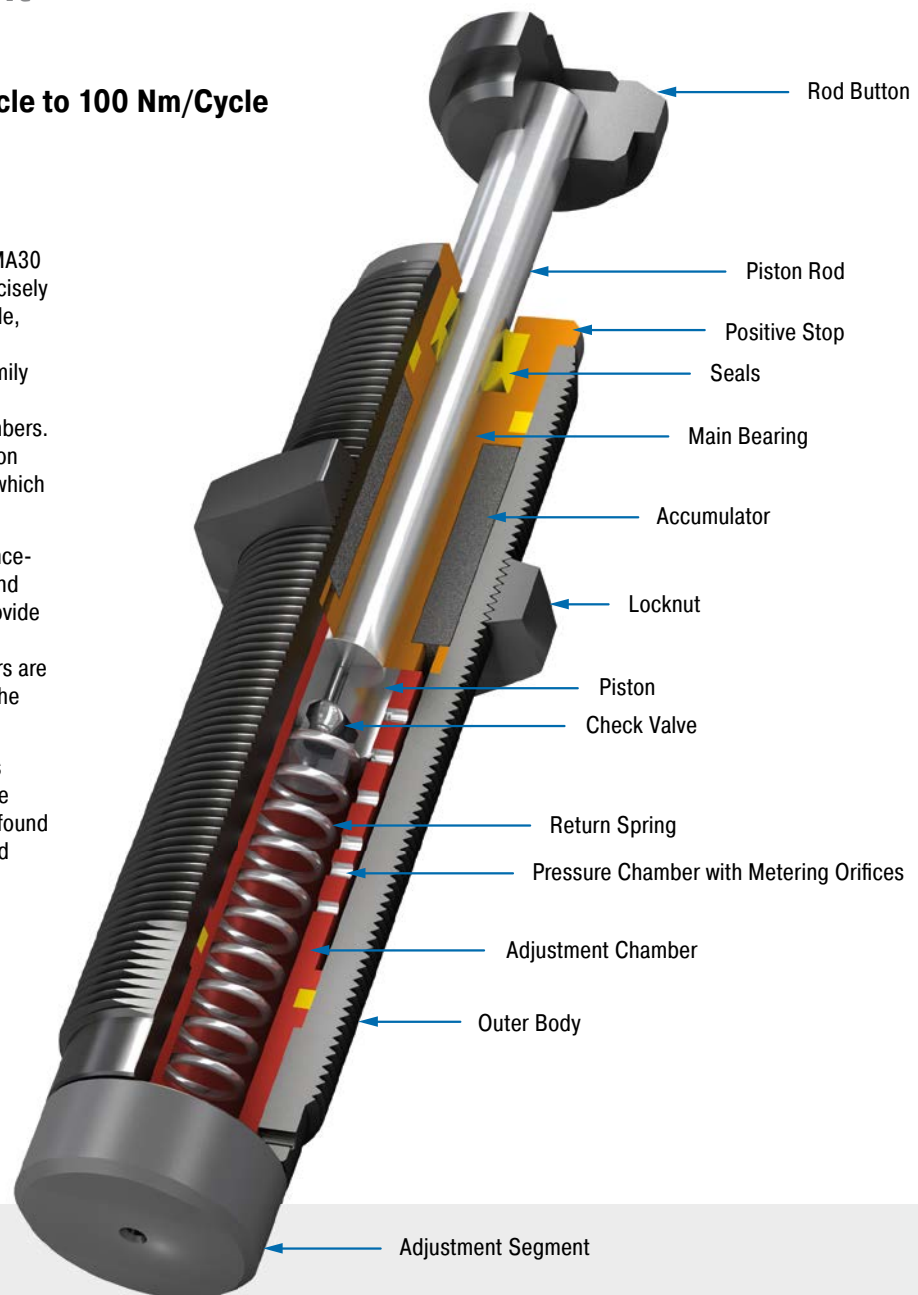

Technical Data

Energy capacity: 3.5 Nm/Cycle to 100 Nm/Cycle

Impact velocity range: 0.15 m/s to 4.5 m/s. Other speeds on request.

Operating temperature range: 0 °C to 66 °C

Mounting: in any position

Positive stop: Integrated

Adjustment: Hard impact at the start of stroke, adjust the ring towards 9 or PLUS. Hard impact at the end of stroke, adjust the ring towards 0 or MINUS.

Material: Outer body, Accessories: steel corrosion-resistant coating; Piston rod: hardened stainless steel

Damping medium: oil, temperature stable

Application field: linear slides, pneumatic cylinders, swivel units, handling modules, machines and plants, finishing and processing centres, automatic machinery, tool machines, locking systems

Note: If precise end position datum is required consider use of the stop collar type AH. Shock absorber is preset at delivery in a neutral position between hard and soft.

Safety instructions: External materials in the surrounding area can attack the seal components and lead to a shorter service life. Please contact ACE for appropriate solution sugges-

tions. Do not paint the shock absorbers due to heat emission.

On request: Nickel-plated or other special options available to special order. Models without rod end button.

MA30EUM

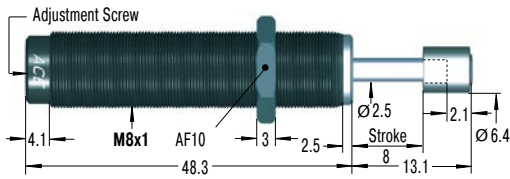

RF8 Rectangular Flange

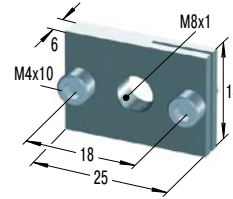

MB8SC2 Mounting Block

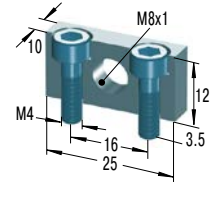

MA50EUM-B

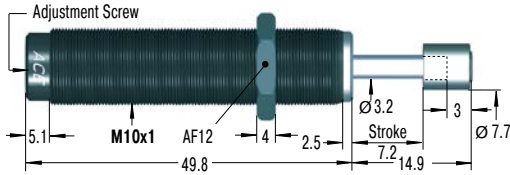

RF10 Rectangular Flange

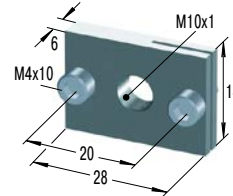

MB10SC2 Mounting Block

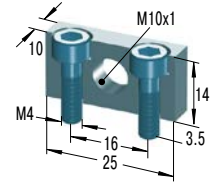

MA35EUM

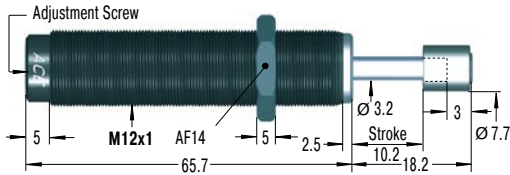

RF12 Rectangular Flange

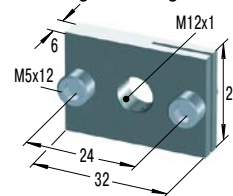

MB12 Clamp Mount

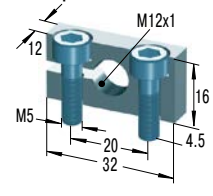

MA150EUM

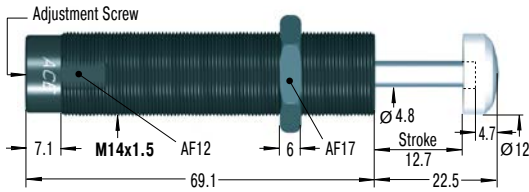

M14x1 also available to special order

RF14 Rectangular Flange

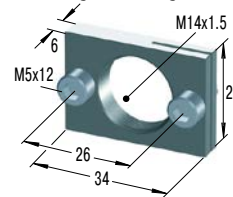

MB14 Clamp Mount

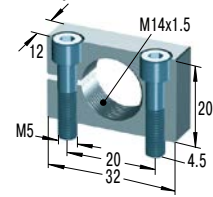

MA225EUM

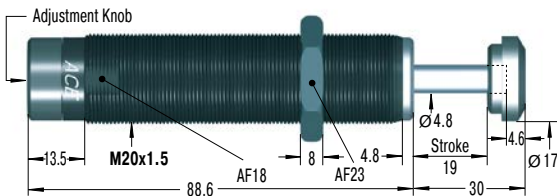

RF20 Rectangular Flange

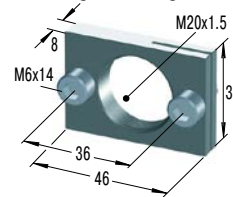

MB20 Clamp Mount

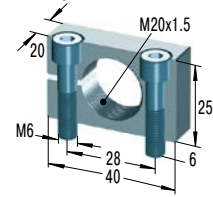

MA600EUM / MA900EUM

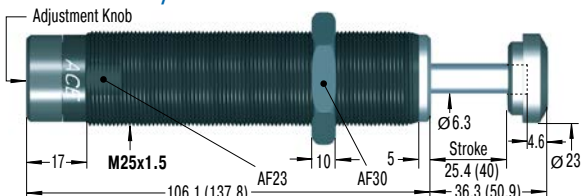

Dimensions for MA900EUM in (). MA600EUM with M27x3 available to special order

RF25 Rectangular Flange

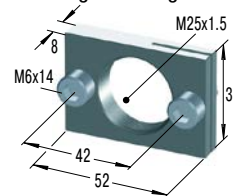

MB25 Clamp Mount

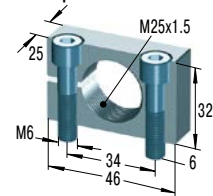

Additional accessories, mounting, installation ... see from page 36.

Performance

TYPES	Max. Energy Capacity		Effective Weight		Return Force min. N	Return Force max. N	Return Time s	Side Load Angle max. °	Weight kg
	W ₃ Nm/cycle	W ₄ Nm/h	me min. kg	me max. kg					
MA30EUM	3.5	5,650	0.23	15	1.7	5.3	0.3	2.0	0.011
MA50EUM-B	5.5	13,550	4.50	20	3.0	6.0	0.3	2.0	0.025
MA35EUM	4.0	6,000	6.00	57	5.0	11.0	0.2	2.0	0.045
MA150EUM	22.0	35,000	1.00	109	3.0	5.0	0.4	2.0	0.061
MA225EUM	25.0	45,000	2.30	226	5.0	10.0	0.1	2.0	0.173
MA600EUM	68.0	68,000	9.00	1,360	10.0	30.0	0.2	2.0	0.352
MA900EUM	100.0	90,000	14.00	2,040	10.0	35.0	0.4	1.0	0.414

¹ For applications with higher side load angles consider using the side load adaptor (BV) pages 38 to 45.

Selection Chart

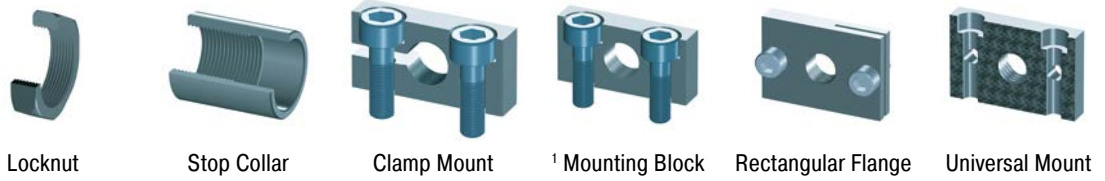

Shock Absorber Type	KM	AH	MB	MBSC2	RF	UM
Thread M5x0.5						
MC5EUM	KM5	AH5	–	MB5SC2	–	–
Thread M6x0.5						
MC9EUM	KM6	AH6	–	MB6SC2	RF6	–
Thread M8x1						
MA30EUM	KM8	AH8	–	MB8SC2	RF8	–
MC10EUM	KM8	AH8	–	MB8SC2	RF8	–
MC30EUM	KM8	AH8	–	MB8SC2	RF8	–
Thread M10x1						
MA50EUM-B	KM10	AH10	–	MB10SC2	RF10	UM10
MC25EUM	KM10	AH10	–	MB10SC2	RF10	UM10
SC25EUM; 5 to 7	KM10	AH10	–	MB10SC2	RF10	UM10
Thread M12x1						
MA35EUM	KM12	AH12	MB12	–	RF12	UM12
MC75EUM	KM12	AH12	MB12	–	RF12	UM12
SC75EUM; 5 to 7	KM12	AH12	–	MB12SC2	RF12	UM12
Thread M14x1.5						
MA150EUM	KM14	AH14	MB14	–	RF14	UM14
MC150EUM	KM14	AH14	MB14	–	RF14	UM14
MC150EUM-V4A	KM14-V4A	AH14-V4A	–	MB14SC2-V4A	–	–
PMCN150EUM	KM14	–	MB14	–	RF14	UM14
PMCN150EUM-V4A	KM14-V4A	–	–	MB14SC2-V4A	–	–
SC190EUM; 0 to 4	KM14	AH14	MB14	–	RF14	UM14
SC190EUM; 5 to 7	KM14	AH14	–	MB14SC2	RF14	UM14
Thread M20x1.5						
MA225EUM	KM20	AH20	MB20	–	RF20	UM20
MC225EUM	KM20	AH20	MB20	–	RF20	UM20
MC225EUM-V4A	KM20-V4A	AH20-V4A	–	MB20SC2-V4A	–	–
PMCN225EUM	KM20	–	MB20	–	RF20	UM20
PMCN225EUM-V4A	KM20-V4A	–	–	MB20SC2-V4A	–	–
SC300EUM; 0 to 4	KM20	AH20	MB20	–	RF20	UM20
SC300EUM; 5 to 9	KM20	AH20	–	MB20SC2	RF20	UM20
Thread M25x1.5						
MA600EUM	KM25	AH25	MB25	–	RF25	UM25
MA900EUM	KM25	AH25	MB25	–	RF25	UM25
MC600EUM	KM25	AH25	MB25	–	RF25	UM25
MC600EUM-V4A	KM25-V4A	AH25-V4A	–	MB25SC2-V4A	–	–
PMCN600EUM	KM25	–	MB25	–	RF25	UM25
PMCN600EUM-V4A	KM25-V4A	–	–	MB25SC2-V4A	–	–
SC650EUM; 0 to 4	KM25	AH25	MB25	–	RF25	UM25
SC650EUM; 5 to 9	KM25	AH25	–	MB25SC2	RF25	UM25
SC925EUM; 0 to 4	KM25	AH25	MB25	–	RF25	UM25

¹ Use a locknut for protection if a clamp mount MB...SC2 is installed.

² Only mountable on units without button.
Remove the button from the shock absorber, if there's one fitted!

Dimensions can be found on the corresponding accessories pages.

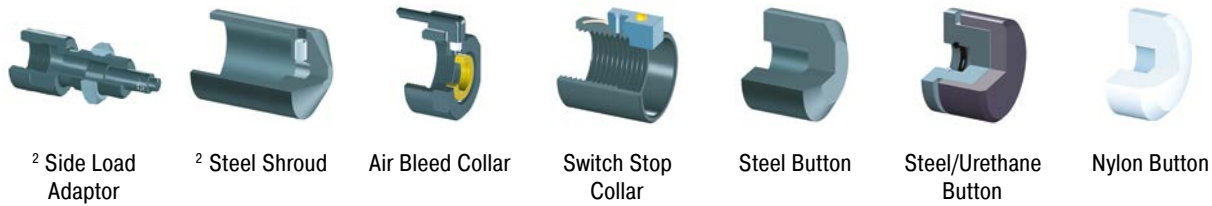

	BV	PB	SP	AS	PS	BP	PP	Page
Thread M5x0.5								
-	-	-	-	-	-	-	-	38
Thread M6x0.5								
-	-	-	-	-	-	-	-	38
Thread M8x1								
BV8	PB8	-	-	-	-	-	-	38
BV8A	PB8-A	-	-	-	-	-	-	38
BV8	PB8	-	-	-	-	-	-	38
Thread M10x1								
BV10	PB10	-	AS10	PS10	-	-	-	39
BV10	PB10	-	AS10	PS10	-	-	-	39
BV10SC	PB10SC	-	-	-	-	-	-	39
Thread M12x1								
BV12	PB12	-	AS12	PS12	-	-	-	39
BV12	PB12	-	AS12	PS12	-	-	-	39
BV12SC	PB12SC	SP12	AS12	PS12SC	-	-	-	39
Thread M14x1.5								
BV14	PB14	SP14	AS14	PS14	-	-	included	40
BV14	PB14	SP14	AS14	PS14	-	-	PP150	40
-	-	-	-	-	-	-	PP150	40
-	-	-	-	-	-	-	-	40
-	-	-	-	-	-	-	-	40
BV14SC	PB14SC	-	AS14	included	BP14	-	-	40
BV14	PB14	SP14	AS14	PS14	-	-	-	40
Thread M20x1.5								
BV20SC	PB20SC	-	AS20	included	BP20	-	-	41
BV20	PB20	SP20	AS20	PS20	-	-	PP225	41
-	-	-	-	-	-	-	PP225	41
-	-	-	-	-	-	-	-	41
-	-	-	-	-	-	-	-	41
BV20SC	PB20SC	-	AS20	included	BP20	-	-	41
BV20SC	PB20SC	-	AS20	included	-	-	-	41
Thread M25x1.5								
BV25SC	PB25SC	-	AS25	included	BP25	-	-	42
-	-	-	AS25	included	BP25	-	-	42
BV25	PB25	SP25	AS25	PS25	-	-	PP600	42
-	-	-	-	-	-	-	PP600	42
-	-	-	-	-	-	-	-	42
-	-	-	-	-	-	-	-	42
BV25SC	PB25SC	-	AS25	included	BP25	-	-	42
BV25SC	PB25	-	AS25	included	-	-	-	42
-	-	-	AS25	included	BP25	-	-	42

For selection chart, see pages 36 to 37

M5x0.5

KM5
Locknut

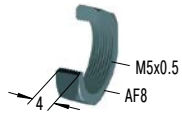

AH5
Stop Collar

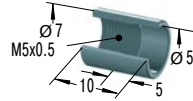

MB5SC2
Mounting Block

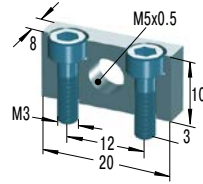

M6x0.5

KM6
Locknut

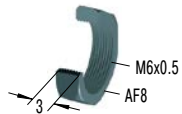

AH6
Stop Collar

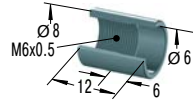

MB6SC2
Mounting Block

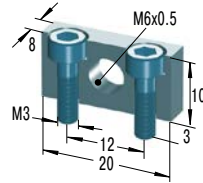

RF6
Rectangular Flange

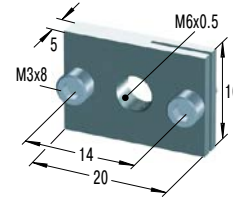

M8x1

KM8
Locknut

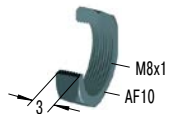

AH8
Stop Collar

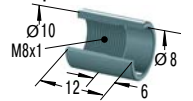

MB8SC2
Mounting Block

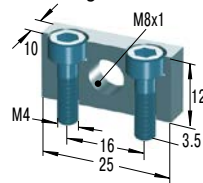

RF8
Rectangular Flange

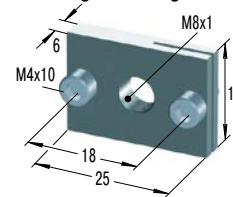

BV8
Side Load Adaptor

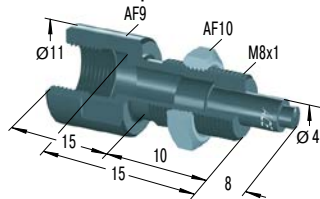

BV8A
Side Load Adaptor

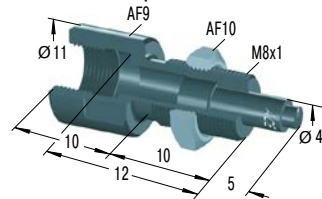

PB8
Steel Shroud

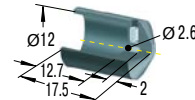

PB8-A
Steel Shroud

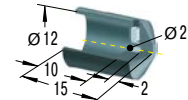

For mounting, installation, ..., see pages 43 to 46.

For selection chart, see pages 36 to 37

M10x1

KM10
Locknut

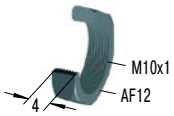

AH10
Stop Collar

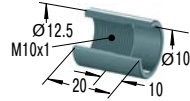

MB10SC2
Mounting Block

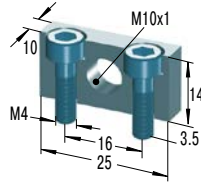

RF10
Rectangular Flange

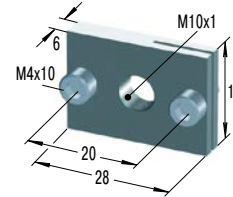

UM10
Universal Mount

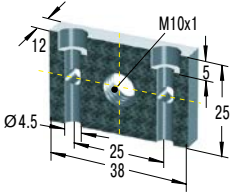

BV10
Side Load Adaptor

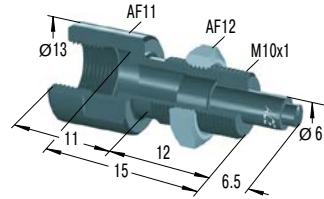

BV10SC
Side Load Adaptor

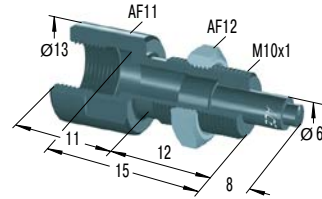

PB10
Steel Shroud

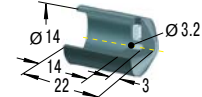

PB10SC
Steel Shroud

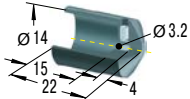

AS10
Switch Stop Collar

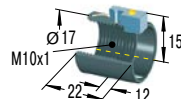

inc. Proximity Switch

PS10
Steel Button

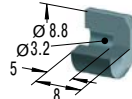

M12x1

KM12
Locknut

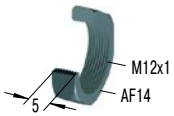

AH12
Stop Collar

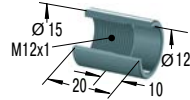

MB12
Clamp Mount

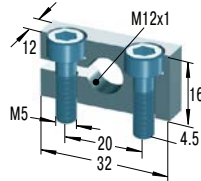

MB12SC2
Mounting Block

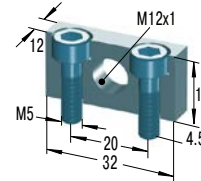

RF12
Rectangular Flange

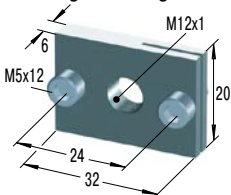

UM12
Universal Mount

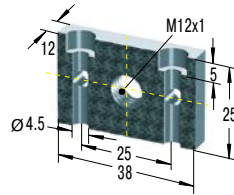

BV12
Side Load Adaptor

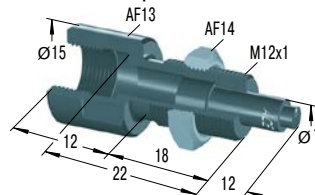

BV12SC
Side Load Adaptor

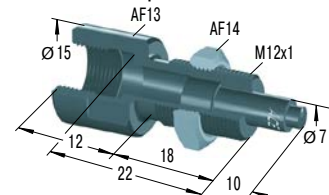

PB12
Steel Shroud

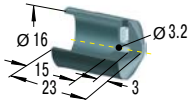

PB12SC
Steel Shroud

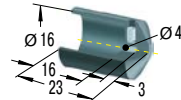

SP12
Air Bleed Collar

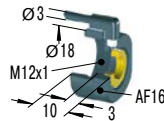

AS12
Switch Stop Collar

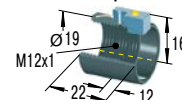

inc. Proximity Switch

PS12
Steel Button

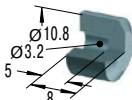

PS12SC
Steel Button

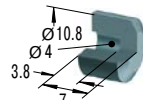

For mounting, installation, ..., see pages 43 to 46.

For selection chart, see pages 36 to 37

M14x1,5

KM14
Locknut

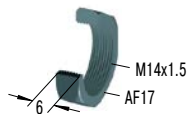

KM14-V4A
Locknut

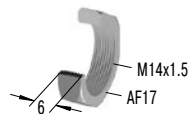

AH14
Stop Collar

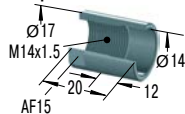

AH14-V4A
Stop Collar

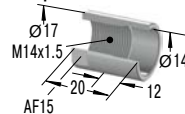

MB14
Clamp Mount

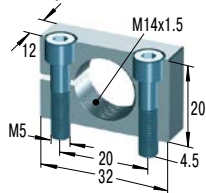

MB14SC2
Mounting Block

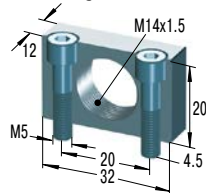

MB14SC2-V4A
Mounting Block

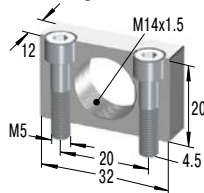

RF14
Rectangular Flange

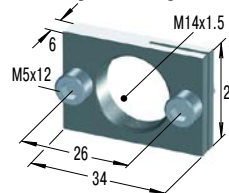

UM14
Universal Mount

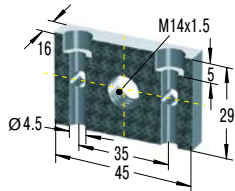

BV14
Side Load Adaptor

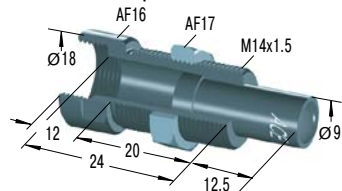

BV14SC
Side Load Adaptor

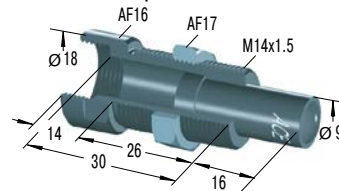

PB14
Steel Shroud

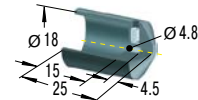

PB14SC
Steel Shroud

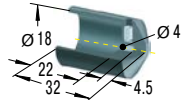

SP14
Air Bleed Collar

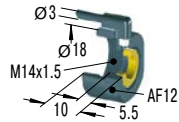

AS14
Switch Stop Collar

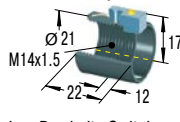

inc. Proximity Switch

PS14
Steel Button

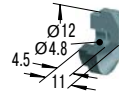

BP14
Steel/Urethane Button

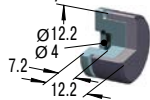

PP150
Nylon Button

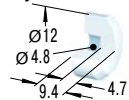

W_s max = 14 Nm

For mounting, installation, ..., see pages 43 to 46.

For selection chart, see pages 36 to 37

M20x1.5

KM20
Locknut

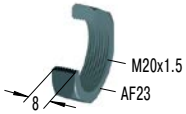

KM20-V4A
Locknut

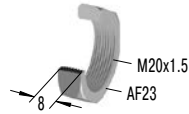

AH20
Stop Collar

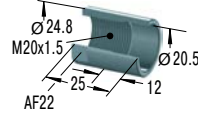

AH20-V4A
Stop Collar

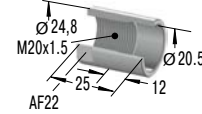

MB20
Clamp Mount

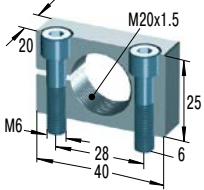

MB20SC2
Mounting Block

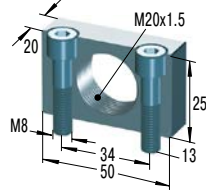

MB20SC2-V4A
Montageblock

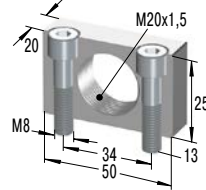

RF20
Rectangular Flange

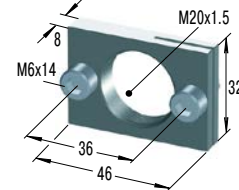

UM20
Universal Mount

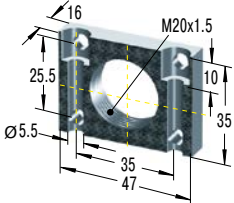

BV20
Side Load Adaptor

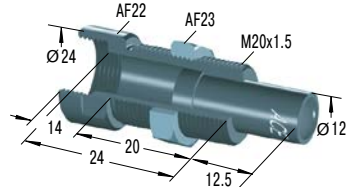

BV20SC
Side Load Adaptor

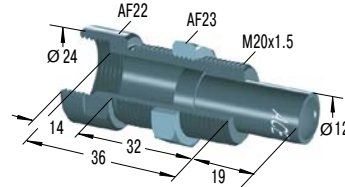

PB20
Steel Shroud

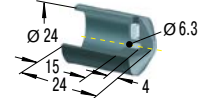

PB20SC
Steel Shroud

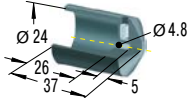

SP20
Air Bleed Collar

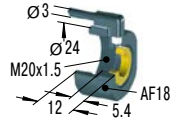

AS20
Switch Stop Collar

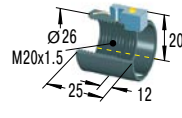

inc. Proximity Switch

PS20
Steel Button

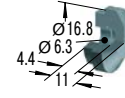

BP20
Steel/Urethane Button

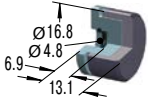

PP225
Nylon Button

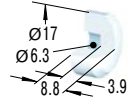

$W_3 \text{ max} = 33 \text{ Nm}$

For selection chart, see pages 36 to 37

M25x1.5

KM25
Locknut

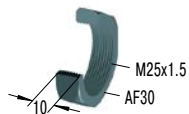

KM25-V4A
Locknut

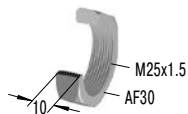

AH25
Stop Collar

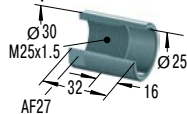

AH25-V4A
Stop Collar

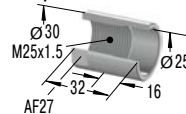

MB25
Clamp Mount

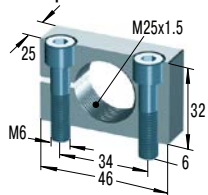

MB25SC2
Mounting Block

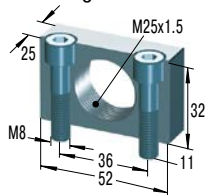

MB25SC2-V4A
Mounting Block

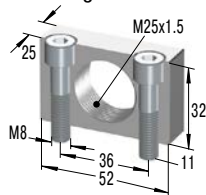

RF25
Rectangular Flange

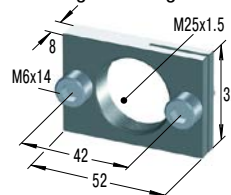

UM25
Universal Mount

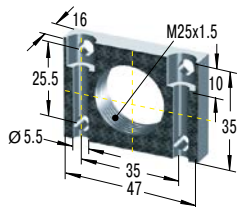

BV25
Side Load Adaptor

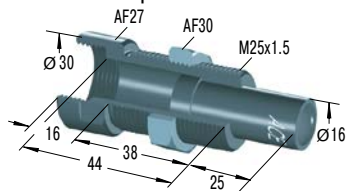

BV25SC
Side Load Adaptor

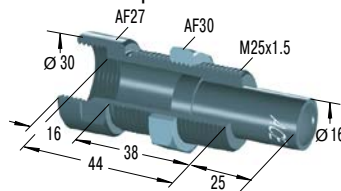

PB25
Steel Shroud

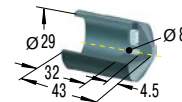

PB25SC
Steel Shroud

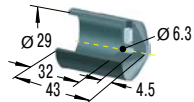

SP25
Air Bleed Collar

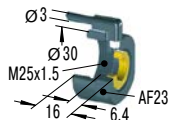

For VC2515FT to VC2555FT
reduction of the stroke 6.4 mm

AS25
Switch Stop Collar

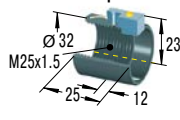

inc. Proximity Switch

PS25
Steel Button

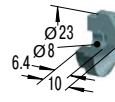

BP25
Steel/Urethane Button

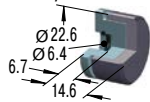

PP600
Nylon Button

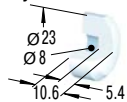

$W_3 \text{ max} = 68 \text{ Nm}$

For mounting, installation, ..., see pages 43 to 46.

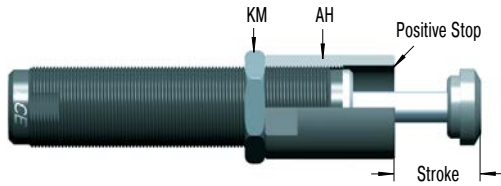
AH

Stop Collar

All ACE miniature shock absorbers have an integral positive stop. An optional stop collar (AH...) can be added if desired to give fine adjustment of final stopping position.

MB

Clamp Mount

When using the MB clamp mount no locknut is needed on the shock absorber (split clamp action). The clamp mount is very compact and allows fine adjustment of the shock absorber position by turning in and out.

Safety instructions

When foot mounting the types with combined piston and inner tube SC²25EUM to SC²650EUM and the types MC5EUM, MC9EUM, MC10EUM, MC30EUM, MC25EUM and MA30EUM, the mounting block MB (SC²) must be used.

Delivery

Two socket head screws are included with the clamp mount.

Dimensions

TYPES	Screw Size	Max. Torque Nm
MB12	M5x16	6
MB14	M5x20	6
MB20	M6x25	11
MB25	M6x30	11

MBSC2

Mounting Block

The mounting block MB...SC2 ensures the stable fixation of shock absorbers of the SC²-Series. Due to the piston tube technology of this series, this mounting block has no clamp slot. The mounting block is also used for types MC5EUM to MC30EUM as well as type MA30EUM.

Mounting information

As the MB (SC²) has no clamp slot, the shock absorber has to be tightened with the supplied locknut.

Delivery

Two socket head screws are included with the clamp mount.

RF

Rectangular Flange

The rectangular flange RF provides a space saving convenient assembly and does not need a lock nut to hold the shock absorber. Therefore achieving a neat, compact and flat surface mounting.

Dimensions

TYPES	Screw Size	Max. Torque Nm
RF6	M3x8	3
RF8	M4x10	4
RF10	M4x10	4
RF12	M5x12	6
RF14	M5x12	6
RF20	M6x14	11
RF25	M6x14	11

PB

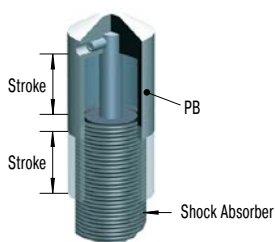

Steel Shroud

Grinding beads, sand, welding splatter, paints and adhesives etc. can adhere to the piston rod. They then damage the rod seals and the shock absorber quickly fails. In many cases the installation of the optional steel shroud can provide worthwhile protection and increase lifetime.

Ordering information

The PB steel shroud can only be installed onto a shock absorber without rod end button.

For part number MA, MC, SC please order with "M-880" suffix. Part numbers MA150EUM, MC150EUM to MC600EUM and SC25EUM to SC190EUM5-7 are supplied without a button.

Safety instructions

When installing don't forget to allow operating space for the shroud to move as the shock absorber is cycled.

SP

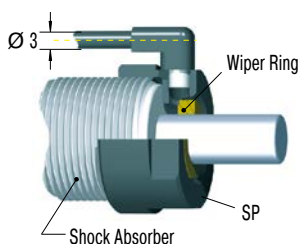

Air Bleed Collar

Air bleed collar (includes integral stop collar) protects shock absorber from ingress of abrasive contaminants like cement, paper or wood dust into the rod seal area. It also prevents aggressive fluids such as cutting oils, coolants etc. damaging the seals. Air bleed supply 0.5 to 1 bar. Low air consumption. The constant air bleed prevents contaminants passing the wiper ring and entering the shock absorber seal area.

Safety instructions

Do not switch off air supply whilst machine is operating! The air bleed collar cannot be used on all similar body thread sized shock absorbers. The air bleed collar is only for types MC150EUM to MC600EUM, MA150EUM, SC75EUM and SC190EUM5-7.

PP

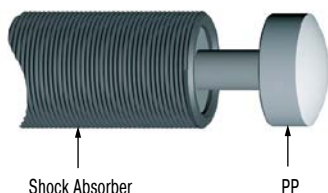

Nylon Button

While the use of industrial shock absorbers already achieves a considerable reduction in noise levels, the additional use of PP impact buttons made of glass fibre reinforced nylon reduces noise levels even further, making it easy to fulfil the regulations of the new Noise Control Ordinance. At the same time, wear of impact surface is drastically minimized. The PP buttons are available for shock absorbers in series MC150EUM to MC600EUM.

Mounting information

The buttons are fitted simply by pressing onto the piston rod. We recommend to additionally fix the nylon button with LOCTITE.

Delivery

Model MA150EUM is supplied as standard with PP button.

BP

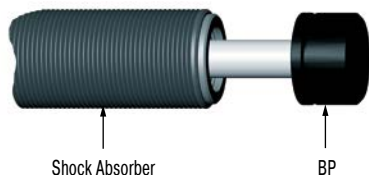

Steel/Urethane Button

These impact buttons made of urethane offer all above advantages of the PP nylon button in terms of reducing noise and wear. They fit easily onto the piston rod of the corresponding shock absorber. BP buttons must additionally be secured with LOCTITE.

Please refer to the accessories table on pages 36 to 37 to see which shock absorber types the BP buttons are available for.

BV

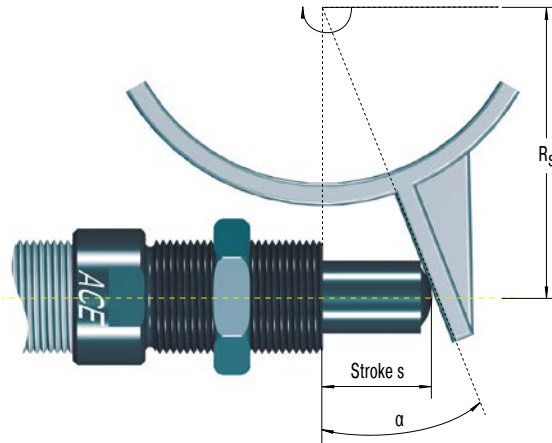
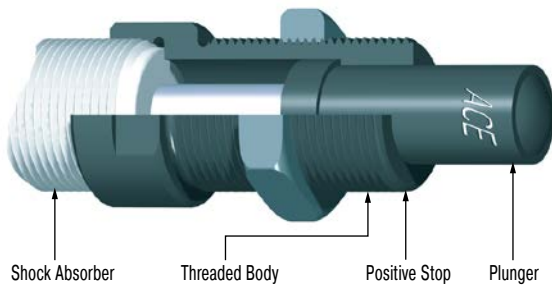

Formulae:

$$\alpha = \tan^{-1} \left(\frac{s}{R_s} \right) \quad R_{s \min} = \frac{s}{\tan \alpha \max}$$

Example:

$$s = 0.025 \text{ m} \quad \alpha \max = 25^\circ \text{ (Type BV25)}$$

$$R_s = 0.1 \text{ m}$$

$$\alpha = \tan^{-1} \left(\frac{0.025}{0.1} \right) \quad R_{s \min} = \frac{0.025}{\tan 25}$$

$$\alpha = 14.04^\circ \quad R_{s \min} = 0.054 \text{ m}$$

α	= side load angle °	R_s	= mounting radius m
$\alpha \max$	= max. angle °	$R_{s \min}$	= min. possible mounting radius m
s	= absorber stroke m		

Side Load Adaptor

Rotating impact motion causes high side load forces on the piston rod. This increases bearing wear and possibly results in rod breakage or bending. With side load impact angles of more than 3° the operation lifetime of the shock absorber reduces rapidly due to increased wear of the rod bearings. The optional BV side load adaptor provides long lasting solution.

Ordering information

The BV adaptor can only be installed onto a shock absorber without rod end button.

Part Number: MA, MC, SC...-880 (Models MC150EUM to MC600EUM and SC²25EUM to SC²190EUM5-7 are supplied as standard without buttons.)

Material

Threaded body and plunger: Hardened high tensile steel, hardened 610 HV1

Mounting information

Secure the side load adaptor with LOCTITE or locknut on the shock absorber.

For material combination plunger/impact plate use similar hardness values. We recommend that you install the shock absorber/side load adaptor using the thread on the side load adaptor.

Installation with clamp mount MB... not possible. Use mounting block MB... SC²!

Safety instructions

Maximum angle:

BV8, BV10 and BV12 = 12.5°

BV14, BV20 and BV25 = 25°

By repositioning the centre of the stroke of the side load plunger to be at 90 degrees to the piston rod, the side load angle can be halved. The use of an external positive stop due to high forces encountered is required.

AS

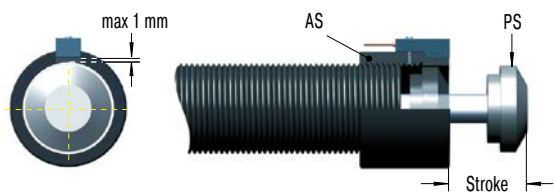

Switch Stop Collar

The ACE stop light switch stop collar combination AS, incl. proximity switch PNP, can be mounted on all popular shock absorber models. The use of the steel button PS is mandatory.

Advantages: Very short, compact mounting package, good price-performance ratio, retrofit possible for standard shock absorber models, fine adjustment of the stroke possible.

Ordering information

The steel button type PS is fitted as standard on the models: SC190EUM0-4, SC300EUM0-9, SC650EUM0-9, SC925EUM0-4, MA/MVC225EUM, MA/MVC600EUM and MA/MVC900EUM. With all other models you must order the PS button as an optional accessory.

Mounting information

We recommend to fix the steel button onto the end of the piston rod using LOCTITE 290. Attention! Take care not to leave any adhesive on the piston rod as this will cause seal damage. Thread the switch stop collar onto the front of the shock absorber and secure in position. Switch cable should not be routed close to power cables.

250-3 PNP

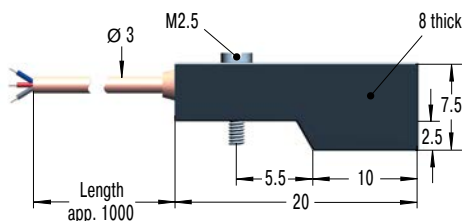

Proximity Switch

The proximity switch is part of the ACE stop light switch collar combination. The correct starting position can thus be checked electronically.

Ordering information

Part number: 250-3 PNP

PNP proximity switch data

- Supply voltage: 10-27 VDC
- Ripple: < 10 %
- Load current max.: 100 mA
- Operating temperature range: -10 °C to +60 °C
- Residual voltage: max. 1 V
- Protection: IP67 (IEC 144) with LED-indicator
- Proximity switch N/Open when shock absorber extended.
- When shock absorber is fully compressed switch closes and LED indicator lights.

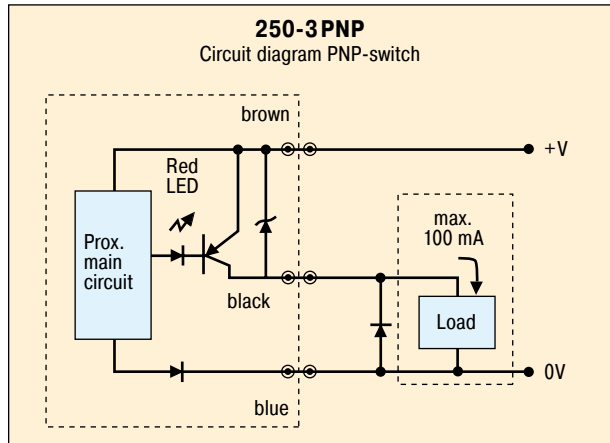

High Performance

for PET Stretch Blow Machines

NEW



PET 20 and PET 27

**20 million cycles – up to 107 °C – aluminium outer body
hardened pressure chamber – corrosion protection**

=

extended service life – low-wear – faster
reduced downtime – improved system performance
increased production volume – high cost efficiency

For all information see our Website www.ace-ace.com

Application Examples

MC25EUM

Constant deceleration force

ACE miniature shock absorbers are the right alternative. This pneumatic module for high precision, high speed motion intentionally abandoned pneumatic end-of-travel damping. The compact miniature shock absorbers of the type MC25EUMH-NB decelerate the linear motion safer and faster when reaching the end-of-travel position. They accept the moving load gently and decelerate it smoothly throughout the entire stroke length. Additional advantages: simpler construction, smaller pneumatic valves, lower maintenance costs as well as reduced compressed air consumption.

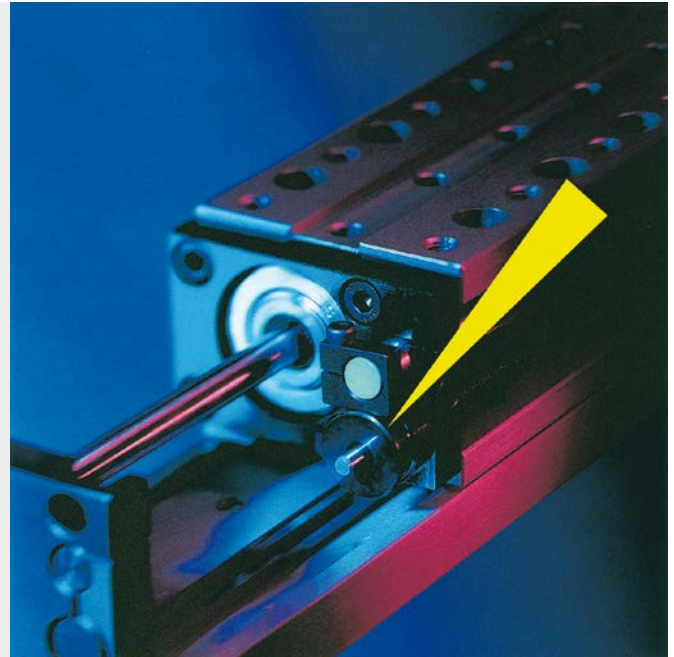
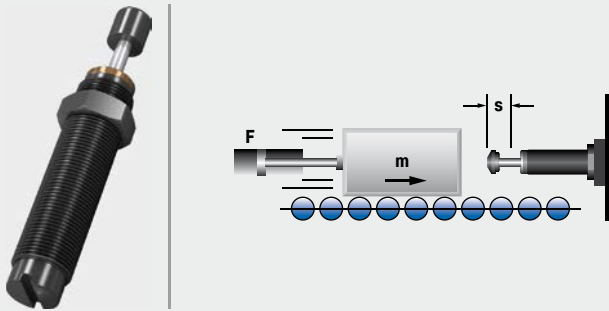

Miniature Shock Absorber in compact pneumatic module

MC225EUM

Obstacle end positions secured

In the case of driving safety training, swinging flags are used to simulate the sudden appearance of obstacles. If the driver reacts too slowly, the flags are swung just as quickly away to avoid damage to the vehicle. In order to protect the end positions of this safety system during to and fro motion, ACE miniature shock absorbers of the type MC225EUMH2 are installed. They come with a special side load adapter for use in this situation. Among other things, this improves the ability of the shock absorber to absorb lateral forces during to and fro motion.

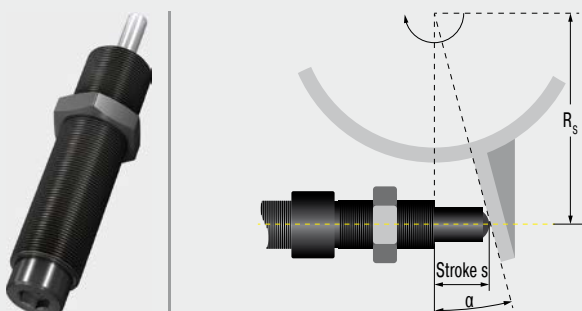

Miniature shock absorbers protect the end positions during driving safety training

Dorning Hytronics GmbH, 4210 Unterweikersdorf, Austria

SC190EUM

Soft end-of-travel damping on rotary movements

ACE miniature shock absorbers optimize production with minimum expenditure. The cycle rate for an assembly line producing electronic components was increased to 3,600 units/hr. Miniature shock absorbers type SC190EUM-1 decelerate the rapid transfer movements on the production line and using soft damping methods optimize the pick up and set down of components. This soft deceleration technique has increased production and reduced maintenance on the portal and rotary actuator modules. The optional side load adaptor protects the shock absorber from high side load forces and increases the operating lifetime. Using ACE shock absorbers reduces maintenance costs by 50 % and running costs by 20 %, diminishing energy consumption.

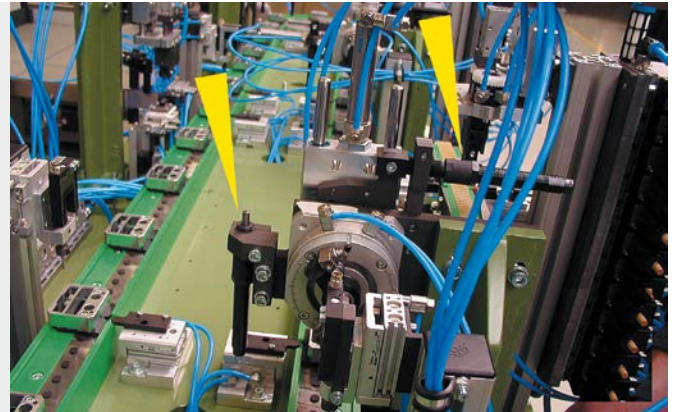

Optimised production in the electronics industry
Stebie Maschinenbau GmbH, Germany

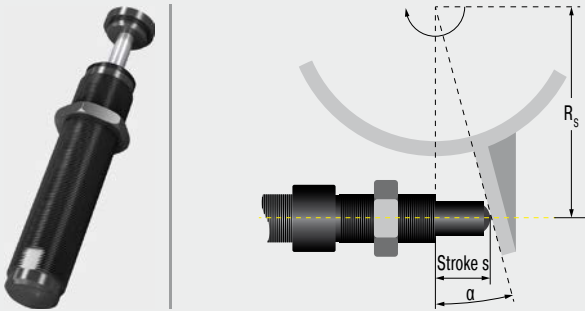

Industrial Shock Absorbers

Absorbers to suit – for all loads

ACE industrial shock absorbers work hard. Their application means moving loads are evenly decelerated over the full stroke. The result: the lowest braking force and shortest braking time. The MAGNUM series from ACE is viewed as the reference standard for medium design sizes in damping technology.

Innovations such as diaphragm accumulators, seals, tube-shaped inner pressure chambers and many more make a decisive contribution towards extension of the service life. This means that the effective load range can be extended considerably, which provides users with more scope with respect to the absorber size and utilisation of the machine's output. ACE offers a wide range of matching accessories for this and all other absorber series. This eliminates internal production of assembly parts, which involves high costs and lots of time.

Innovative damping techniques

Reference class for medium sizes

Less stress on the machine

Increase of production figures

Long machine service lives



Industrial Shock Absorbers



MC33 to MC64

Page 52

Self-Compensating

High energy absorption and robust design

Linear slides, Swivel units, Turntables, Portal systems



MC33-V4A to MC64-V4A

Page 56

self-Compensating, stainless Steel

Optimum corrosion protection

Linear slides, Swivel units, Turntables, Food industry



MC33-HT to MC64-HT

Page 60

Self-Compensating

Extreme temperatures and high cycle frequencies

Linear slides, Swivel units, Turntables, Machines and plants



MC33-LT to MC64-LT

Page 64

Self-Compensating

Extreme temperatures and high cycle frequencies

Linear slides, Swivel units, Turntables, Machines and plants



SC33 to SC45

Page 68

Self-Compensating, Piston Tube Technology

Piston tube design for maximum energy absorption

Turntables, Swivel units, Robot arms, Linear slides



MA/ML33 to MA/ML64

Page 70

Adjustable

High energy absorption and progressive adjustment

Linear slides, Swivel units, Turntables, Portal systems

MC33 to MC64

High energy absorption and robust design

Self-Compensating

Energy capacity 170 Nm/Cycle to 5,650 Nm/Cycle

Stroke 23.1 mm to 150 mm

The latest damper technology: The combination of the latest sealing technology, annealed guide bearing and integrated positiv stop make these self-compensating shock absorbers from ACE'S MAGNUM range so successful. After all, users benefit from the longer service life of the products, even in the most difficult environments. A continuous outer thread and extensive accessories make their contribution to the success story of the MC33 to MC64.

High energy absorption in a compact design and a wide damping range lead to huge advantages in practice. Alongside generally more compact designs, these small yet very powerful absorbers enable full use of the machine's performance.

These self-compensating industrial shock absorbers are used in all areas of mechanical engineering – especially in automation and for gantries.

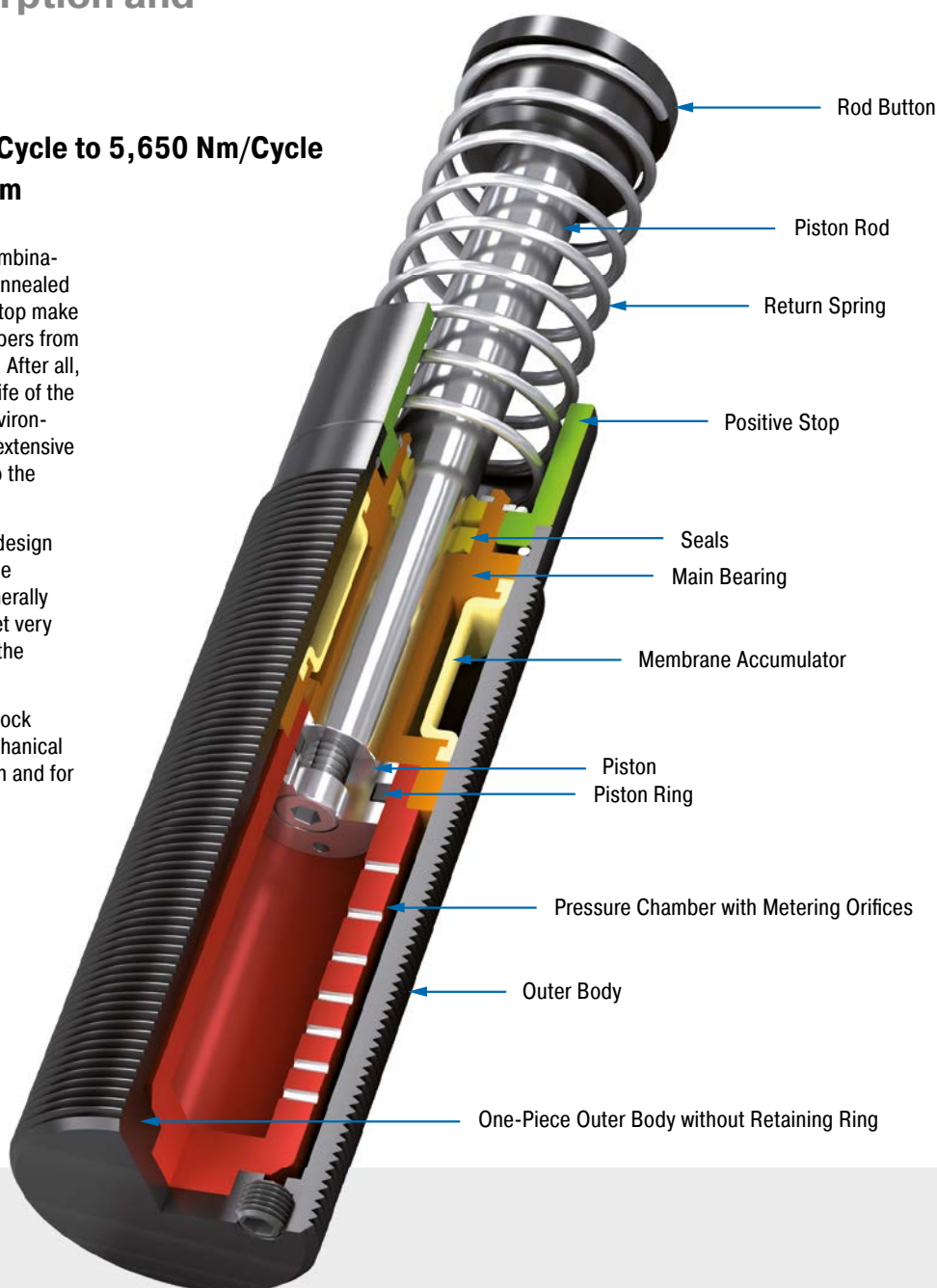

Technical Data

Energy capacity: 170 Nm/Cycle to 5,650 Nm/Cycle

Impact velocity range: 0.15 m/s to 5 m/s. Other speeds on request.

Operating temperature range: -12 °C to +66 °C. Other temperatures on request.

Mounting: In any position

Positive stop: Integrated

Material: Outer body: Nitride hardened steel; Piston rod: Hard chrome plated steel; Rod end button: Hardened steel and corrosion-resistant coating; Return spring: Zinc plated or plastic-coated steel; Accessories: Steel with black oxide finish or nitride hardened

Damping medium: Automatic Transmission Fluid (ATF)

Application field: Linear slides, Swivel units, Turntables, Portal systems, Machines and plants, Tool machines, Machining centres, Z-axes, Impact panels

Note: A noise reduction of 3 to 7 dB is possible when using the special impact button (PP). For emergency use only applications and for continuous use (with additional cooling) it is sometimes possible to exceed the published max. capacity ratings. In this case, please consult ACE.

Safety instructions: External materials in the surrounding area can attack the seal compo-

nents and lead to a shorter service life. Please contact ACE for appropriate solution suggestions. Do not paint the shock absorbers due to heat emission.

On request: Special oils, nickel-plated, increased corrosion protection, mounting inside air cylinders or other special options are available on request.

MC33EUM

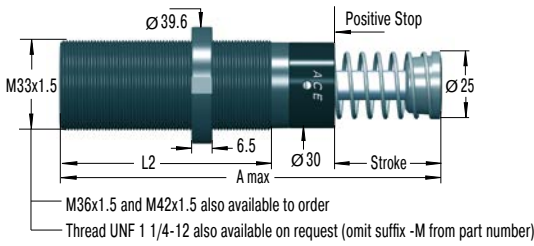

NM33 Locking Ring

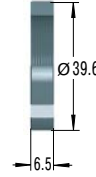

QF33 Square Flange

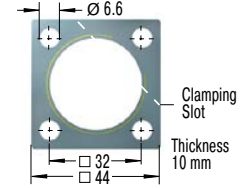

Torque max.: 11 Nm
Clamping torque: > 90 Nm
Install with 4 machine screws

The calculation and selection of the most suitable damper should be carried out or be approved by ACE.

Model Type Prefix

Standard Models

MC: Self-Contained with return spring, self-compensating

Special Models

MCA: Air/Oil return without return spring.

Use only with external air/oil tank.

MCS: Air/Oil return with return spring.

Use only with external air/oil tank.

MCN: Self-Contained without return spring

Ordering Example

MC3325EUM-1

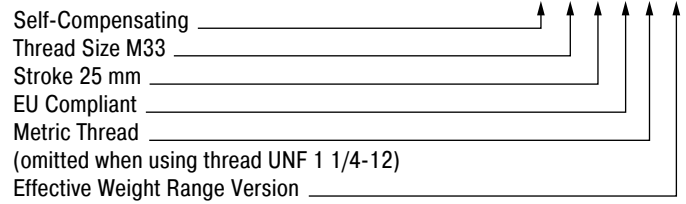

Dimensions

TYPES	Stroke mm	A max. mm	L2 mm
MC3325EUM	23.2	138	83
MC3350EUM	48.6	189	108

Performance

TYPES	Max. Energy Capacity				Effective Weight			Return Force min. N	Return Force max. N	Return Time s	Side Load Angle max. °	Weight kg
	¹ W ₃ Nm/cycle	W ₄ Nm/h	W ₄ with Air/Oil Tank Nm/h	W ₄ with Oil Recirculation Nm/h	² me min. kg	² me max. kg	Hardness					
MC3325EUM-0	170	75,000	124,000	169,000	3	11	-0	45	90	0.03	4	0.51
MC3325EUM-1	170	75,000	124,000	169,000	9	40	-1	45	90	0.03	4	0.51
MC3325EUM-2	170	75,000	124,000	169,000	30	120	-2	45	90	0.03	4	0.51
MC3325EUM-3	170	75,000	124,000	169,000	100	420	-3	45	90	0.03	4	0.51
MC3325EUM-4	170	75,000	124,000	169,000	350	1,420	-4	45	90	0.03	4	0.51
MC3350EUM-0	330	85,000	135,000	180,000	5	22	-0	45	135	0.06	3	0.63
MC3350EUM-1	330	85,000	135,000	180,000	18	70	-1	45	135	0.06	3	0.63
MC3350EUM-2	330	85,000	135,000	180,000	60	250	-2	45	135	0.06	3	0.63
MC3350EUM-3	330	85,000	135,000	180,000	210	840	-3	45	135	0.06	3	0.63
MC3350EUM-4	330	85,000	135,000	180,000	710	2,830	-4	45	135	0.06	3	0.63

¹ For emergency use only applications it is sometimes possible to exceed the above ratings. Please consult ACE for further details.

² The effective weight range limits can be raised or lowered to special order.

³ For applications with higher side load angles consider using the side load adaptor (BV) pages 74 to 77.

Self-Compensating

MC45EUM

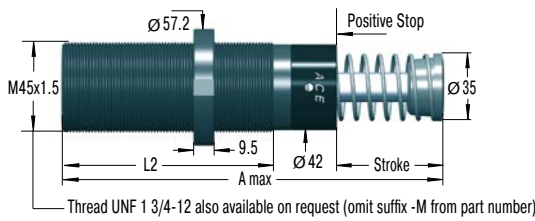

NM45
Locking Ring

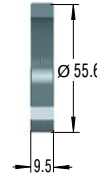

QF45
Square Flange

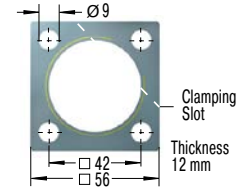

Torque max.: 27 Nm
Clamping torque: > 200 Nm
Install with 4 machine screws

The calculation and selection of the most suitable damper should be carried out or be approved by ACE.

Model Type Prefix

Standard Models

MC: Self-Contained with return spring, self-compensating

Special Models

MCA: Air/Oil return without return spring.
Use only with external air/oil tank.

MCS: Air/Oil return with return spring.
Use only with external air/oil tank.

MCN: Self-Contained without return spring

Ordering Example

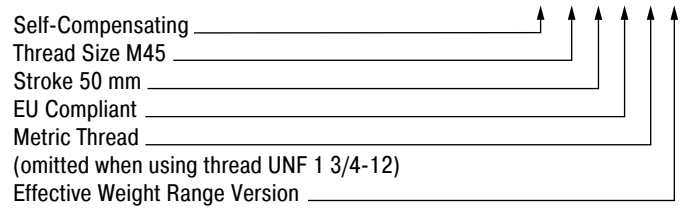

Dimensions

TYPES	Stroke mm	A max. mm	L2 mm
MC4525EUM	23.1	145	95
MC4550EUM	48.5	195	120
MC4575EUM	73.9	246	145

Performance

TYPES	Max. Energy Capacity				Effective Weight			Return Force min. N	Return Force max. N	Return Time s	Side Load Angle max. °	Weight kg
	¹ W ₃ Nm/cycle	W ₄ Nm/h	W ₄ with Air/Oil Tank Nm/h	W ₄ with Oil Recirculation Nm/h	² me min. kg	² me max. kg	Hardness					
MC4525EUM-0	370	107,000	158,000	192,000	7	27	-0	70	100	0.03	4	1.14
MC4525EUM-1	370	107,000	158,000	192,000	20	90	-1	70	100	0.03	4	1.14
MC4525EUM-2	370	107,000	158,000	192,000	80	310	-2	70	100	0.03	4	1.14
MC4525EUM-3	370	107,000	158,000	192,000	260	1,050	-3	70	100	0.03	4	1.14
MC4525EUM-4	370	107,000	158,000	192,000	890	3,540	-4	70	100	0.03	4	1.14
MC4550EUM-0	740	112,000	192,000	248,000	13	54	-0	70	145	0.08	3	1.36
MC4550EUM-1	740	112,000	192,000	248,000	45	180	-1	70	145	0.08	3	1.36
MC4550EUM-2	740	112,000	192,000	248,000	150	620	-2	70	145	0.08	3	1.36
MC4550EUM-3	740	112,000	192,000	248,000	520	2,090	-3	70	145	0.08	3	1.36
MC4550EUM-4	740	112,000	192,000	248,000	1,800	7,100	-4	70	145	0.08	3	1.36
MC4575EUM-0	1,130	146,000	225,000	282,000	20	80	-0	50	180	0.11	2	1.59
MC4575EUM-1	1,130	146,000	225,000	282,000	70	270	-1	50	180	0.11	2	1.59
MC4575EUM-2	1,130	146,000	225,000	282,000	230	930	-2	50	180	0.11	2	1.59
MC4575EUM-3	1,130	146,000	225,000	282,000	790	3,140	-3	50	180	0.11	2	1.59
MC4575EUM-4	1,130	146,000	225,000	282,000	2,650	10,600	-4	50	180	0.11	2	1.59

¹ For emergency use only applications it is sometimes possible to exceed the above ratings. Please consult ACE for further details.

² The effective weight range limits can be raised or lowered to special order.

³ For applications with higher side load angles consider using the side load adaptor (BV) pages 74 to 77.

MC64EUM

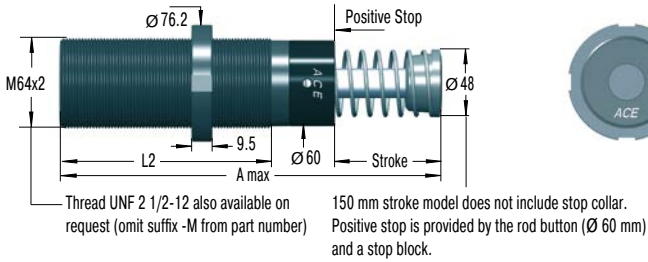

NM64 Locking Ring

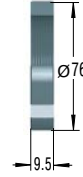

QF64 Square Flange

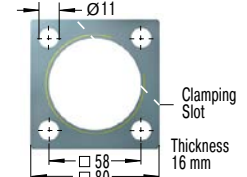

Torque max.: 50 Nm
Clamping torque: > 210 Nm
Install with 4 machine screws

The calculation and selection of the most suitable damper should be carried out or be approved by ACE.

Model Type Prefix

Standard Models

MC: Self-Contained with return spring, self-compensating

Special Models

MCA: Air/Oil return without return spring.
Use only with external air/oil tank.

MCS: Air/Oil return with return spring.
Use only with external air/oil tank.

MCN: Self-Contained without return spring

Ordering Example

Self-Compensating **MC64100EUM-2**
Thread Size M64
Stroke 100 mm
EU Compliant
Metric Thread
(omitted when using thread UNF 2 1/2-12)
Effective Weight Range Version

Dimensions

TYPES	Stroke mm	A max. mm	L2 mm
MC6450EUM	48.6	225	140
MC64100EUM	99.4	326	191
MC64150EUM	150	450	241

Performance

TYPES	Max. Energy Capacity				Effective Weight			Return Force min. N	Return Force max. N	Return Time s	Side Load Angle max. °	Weight kg
	¹ W ₃ Nm/cycle	W ₄ Nm/h	W ₄ with Air/Oil Tank Nm/h	W ₄ with Oil Recirculation Nm/h	² me min. kg	² me max. kg	Hardness					
MC6450EUM-0	1,870	146,000	293,000	384,000	35	140	-0	90	155	0.12	4	2.9
MC6450EUM-1	1,870	146,000	293,000	384,000	140	540	-1	90	155	0.12	4	2.9
MC6450EUM-2	1,870	146,000	293,000	384,000	460	1,850	-2	90	155	0.12	4	2.9
MC6450EUM-3	1,870	146,000	293,000	384,000	1,600	6,300	-3	90	155	0.12	4	2.9
MC6450EUM-4	1,870	146,000	293,000	384,000	5,300	21,200	-4	90	155	0.12	4	2.9
MC64100EUM-0	3,730	192,000	384,000	497,000	70	280	-0	105	270	0.34	3	3.7
MC64100EUM-1	3,730	192,000	384,000	497,000	270	1,100	-1	105	270	0.34	3	3.7
MC64100EUM-2	3,730	192,000	384,000	497,000	930	3,700	-2	105	270	0.34	3	3.7
MC64100EUM-3	3,730	192,000	384,000	497,000	3,150	12,600	-3	105	270	0.34	3	3.7
MC64100EUM-4	3,730	192,000	384,000	497,000	10,600	42,500	-4	105	270	0.34	3	3.7
MC64150EUM-0	5,650	248,000	497,000	644,000	100	460	-0	75	365	0.48	2	5.1
MC64150EUM-1	5,650	248,000	497,000	644,000	410	1,640	-1	75	365	0.48	2	5.1
MC64150EUM-2	5,650	248,000	497,000	644,000	1,390	5,600	-2	75	365	0.48	2	5.1
MC64150EUM-3	5,650	248,000	497,000	644,000	4,700	18,800	-3	75	365	0.48	2	5.1
MC64150EUM-4	5,650	248,000	497,000	644,000	16,000	63,700	-4	75	365	0.48	2	5.1

¹ For emergency use only applications it is sometimes possible to exceed the above ratings. Please consult ACE for further details.

² The effective weight range limits can be raised or lowered to special order.

³ For applications with higher side load angles consider using the side load adaptor (BV) pages 74 to 77.

MC33-V4A to MC64-V4A

Optimum corrosion protection

self-Compensating, stainless Steel

Energy capacity 170 Nm/Cycle to 3,730 Nm/Cycle

Stroke 23.1 mm to 99.4 mm

The latest damper technology in stainless steel: The self-compensating industrial shock absorbers MC33 to MC64 from the tried-and-tested and popular MAGNUM range is also available with all outer components made from stainless steel, material 1.4404 (except piston rod). They are filled in the factory with special oil, which meets the permit conditions (NSF-H1) for the food industry.

Just like the standard product family, the MAGNUM stainless steel models are distinguished by their robust, modern sealing technology, high energy absorption in a compact design, integrated positive stop and a wide damping range. Equipped with a PU head, they are available in thread sizes M33x1.5 to M64x2 with damping strokes up to 100 mm.

These self-compensating industrial shock absorbers made of stainless steel from ACE are mainly used in the food, medical, electro and offshore industries, but also in many other markets.

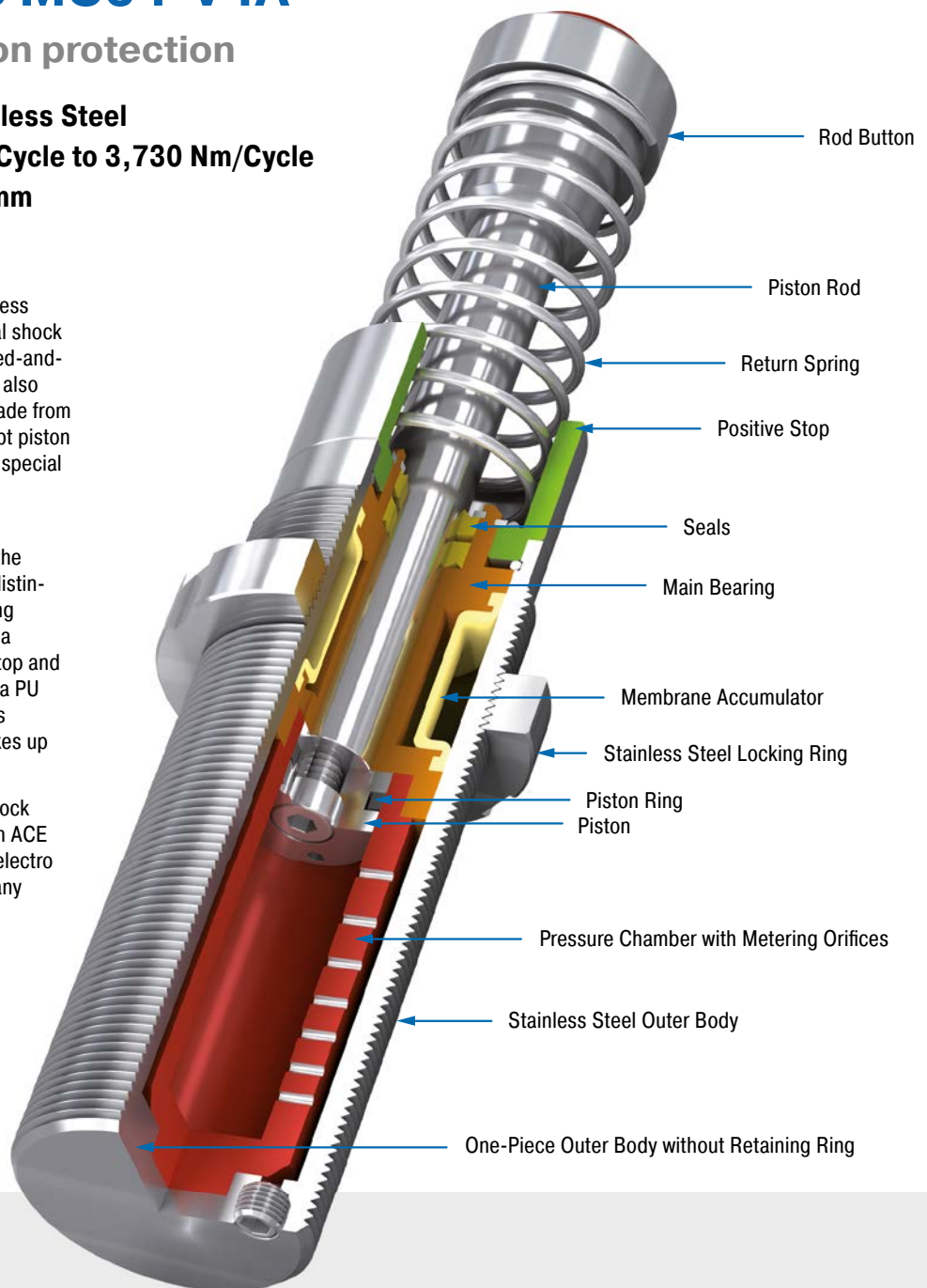

Technical Data

Energy capacity: 170 Nm/Cycle to 3,730 Nm/Cycle

Impact velocity range: 0.15 m/s to 5 m/s. Other speeds on request.

Operating temperature range: -12 °C to +66 °C. Other temperatures on request.

Mounting: In any position

Positive stop: Integrated

Material: Outer body, Main bearing, Accessories, Locking ring: Stainless steel (1.4404, AISI 316L); Piston rod: Hard chrome plated steel; Rod end button: Stainless steel (1.4404, AISI 316L) with elastomer insert; Return spring: Stainless steel

Damping medium: Special oil NSF-H1 approved

Application field: Linear slides, Swivel units, Turntables, Food industry, Medical technology, Portal systems, Machines and plants, Tool machines, Machining centres

Note: Impact button (PP) for noise reduction included. For emergency use only applications and for continuous use (with additional cooling) it is sometimes possible to exceed the published max. capacity ratings. In this case, please consult ACE.

Safety instructions: External materials in the surrounding area can attack the seal components and lead to a shorter service life. Please

contact ACE for appropriate solution suggestions. Do not paint the shock absorbers due to heat emission.

On request: Special oils, other special options and special accessories are available on request.

MC33EUM-V4A

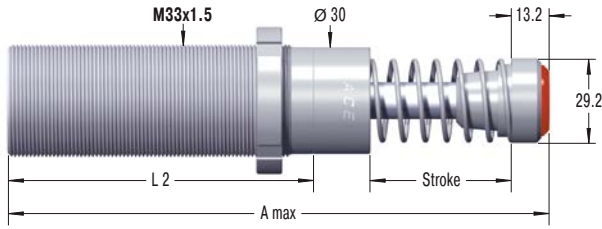

NM33-V4A Locking Ring

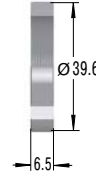

QF33-V4A Square Flange

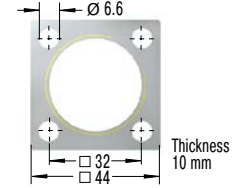

The calculation and selection of the most suitable damper should be carried out or be approved by ACE.

Model Type Prefix

Standard Models

MC: Self-Contained with return spring, self-compensating

Special Models

MCA: Air/Oil return without return spring.

Use only with external air/oil tank.

MCS: Air/Oil return with return spring.

Use only with external air/oil tank.

MCN: Self-Contained without return spring

Ordering Example

MC3325EUM-2-V4A

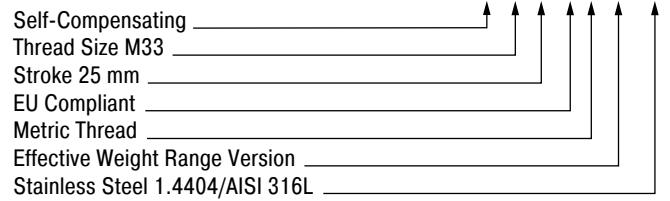

Performance and Dimensions

TYPES	Max. Energy Capacity		Effective Weight			Stroke mm	A max. mm	L2 mm	Return Force		Return Time s	Side Load		Weight kg
	W ₃ Nm/cycle	W ₄ Nm/h	¹ me min. kg	¹ me max. kg	Hardness				min. N	max. N		Angle max. °	kg	
MC3325EUM-0-V4A	170	75,000	3	11	-0	23.2	151.2	83	45	90	0.03	4	0.51	
MC3325EUM-1-V4A	170	75,000	9	40	-1	23.2	151.2	83	45	90	0.03	4	0.51	
MC3325EUM-2-V4A	170	75,000	30	120	-2	23.2	151.2	83	45	90	0.03	4	0.51	
MC3325EUM-3-V4A	170	75,000	100	420	-3	23.2	151.2	83	45	90	0.03	4	0.51	
MC3325EUM-4-V4A	170	75,000	350	1,420	-4	23.2	151.2	83	45	90	0.03	4	0.51	
MC3350EUM-0-V4A	330	85,000	5	22	-0	48.6	202.2	108	45	135	0.06	3	0.63	
MC3350EUM-1-V4A	330	85,000	18	70	-1	48.6	202.2	108	45	135	0.06	3	0.63	
MC3350EUM-2-V4A	330	85,000	60	250	-2	48.6	202.2	108	45	135	0.06	3	0.63	
MC3350EUM-3-V4A	330	85,000	210	840	-3	48.6	202.2	108	45	135	0.06	3	0.63	
MC3350EUM-4-V4A	330	85,000	710	2,830	-4	48.6	202.2	108	45	135	0.06	3	0.63	

¹ For emergency use only applications it is sometimes possible to exceed the above ratings. Please consult ACE for further details.

² For applications with higher side load angles consider using the side load adaptor (BV) pages 74 to 77.

self-Compensating, stainless Steel

MC45EUM-V4A

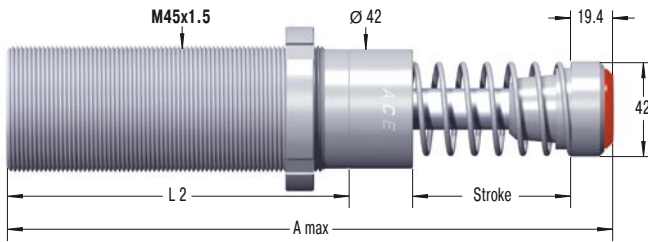

NM45-V4A
Locking Ring

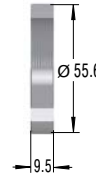

QF45-V4A
Square Flange

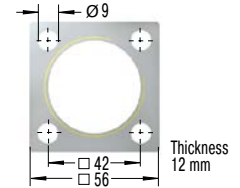

The calculation and selection of the most suitable damper should be carried out or be approved by ACE.

Model Type Prefix

Standard Models

MC: Self-Contained with return spring, self-compensating

Special Models

MCA: Air/Oil return without return spring.
Use only with external air/oil tank.

MCS: Air/Oil return with return spring.
Use only with external air/oil tank.

MCN: Self-Contained without return spring

Ordering Example

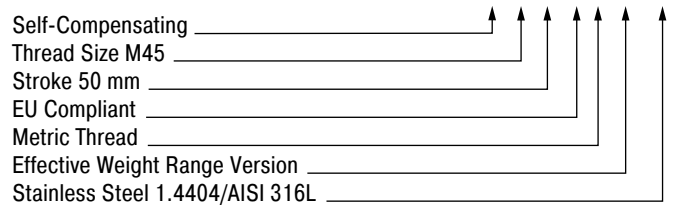

Performance and Dimensions

TYPES	Max. Energy Capacity		Effective Weight			Stroke mm	A max. mm	L2 mm	Return Force		Return Time s	Side Load		Weight kg
	W ₃ Nm/cycle	W ₄ Nm/h	¹ me min. kg	¹ me max. kg	Hardness				min. N	max. N		Angle max. °	kg	
MC4525EUM-0-V4A	370	107,000	7	27	-0	23.1	164.5	95	70	100	0.03	4	1.14	
MC4525EUM-1-V4A	370	107,000	20	90	-1	23.1	164.5	95	70	100	0.03	4	1.14	
MC4525EUM-2-V4A	370	107,000	80	310	-2	23.1	164.5	95	70	100	0.03	4	1.14	
MC4525EUM-3-V4A	370	107,000	260	1,050	-3	23.1	164.5	95	70	100	0.03	4	1.14	
MC4525EUM-4-V4A	370	107,000	890	3,540	-4	23.1	164.5	95	70	100	0.03	4	1.14	
MC4550EUM-0-V4A	740	112,000	13	54	-0	48.5	214.4	120	70	145	0.08	3	1.36	
MC4550EUM-1-V4A	740	112,000	45	180	-1	48.5	214.4	120	70	145	0.08	3	1.36	
MC4550EUM-2-V4A	740	112,000	150	620	-2	48.5	214.4	120	70	145	0.08	3	1.36	
MC4550EUM-3-V4A	740	112,000	520	2,090	-3	48.5	214.4	120	70	145	0.08	3	1.36	
MC4550EUM-4-V4A	740	112,000	1,800	7,100	-4	48.5	214.4	120	70	145	0.08	3	1.36	
MC4575EUM-0-V4A	1,130	146,000	20	80	-0	73.9	265.4	145	50	180	0.11	2	1.59	
MC4575EUM-1-V4A	1,130	146,000	70	270	-1	73.9	265.4	145	50	180	0.11	2	1.59	
MC4575EUM-2-V4A	1,130	146,000	230	930	-2	73.9	265.4	145	50	180	0.11	2	1.59	
MC4575EUM-3-V4A	1,130	146,000	790	3,140	-3	73.9	265.4	145	50	180	0.11	2	1.59	
MC4575EUM-4-V4A	1,130	146,000	2,650	10,600	-4	73.9	265.4	145	50	180	0.11	2	1.59	

¹ For emergency use only applications it is sometimes possible to exceed the above ratings. Please consult ACE for further details.

² For applications with higher side load angles consider using the side load adaptor (BV) pages 74 to 77.

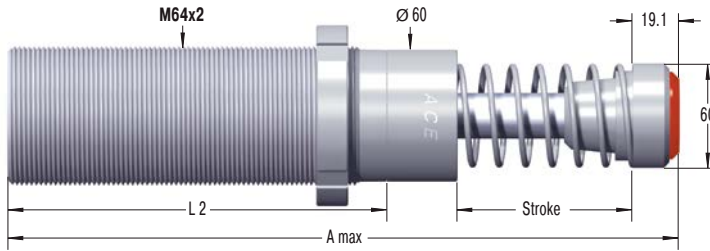
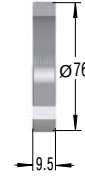
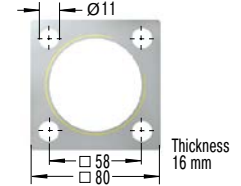
MC64EUM-V4A

NM64-V4A
Locking Ring

QF64-V4A
Square Flange

The calculation and selection of the most suitable damper should be carried out or be approved by ACE.

Model Type Prefix
Standard Models

MC: Self-Contained with return spring, self-compensating

Special Models

MCA: Air/Oil return without return spring.

Use only with external air/oil tank.

MCS: Air/Oil return with return spring.

Use only with external air/oil tank.

MCN: Self-Contained without return spring

Ordering Example
MC6450EUM-3-V4A

Self-Compensating _____ ↑
 Thread Size M64 _____ ↑
 Stroke 50 mm _____ ↑
 EU Compliant _____ ↑
 Metric Thread _____ ↑
 Effective Weight Range Version _____ ↑
 Stainless Steel 1.4404/AISI 316L _____ ↑

Performance and Dimensions

TYPES	Max. Energy Capacity		Effective Weight			Stroke mm	A max. mm	L2 mm	Return Force		Return Time s	Side Load		Weight kg
	W ₃ Nm/cycle	W ₄ Nm/h	¹ me min. kg	¹ me max. kg	Hardness				min. N	max. N		Angle max. °		
MC6450EUM-0-V4A	1,870	146,000	35	140	-0	48.6	244.1	140	90	155	0.12	4	2.9	
MC6450EUM-1-V4A	1,870	146,000	140	540	-1	48.6	244.1	140	90	155	0.12	4	2.9	
MC6450EUM-2-V4A	1,870	146,000	460	1,850	-2	48.6	244.1	140	90	155	0.12	4	2.9	
MC6450EUM-3-V4A	1,870	146,000	1,600	6,300	-3	48.6	244.1	140	90	155	0.12	4	2.9	
MC6450EUM-4-V4A	1,870	146,000	5,300	21,200	-4	48.6	244.1	140	90	155	0.12	4	2.9	
MC64100EUM-0-V4A	3,730	192,000	70	280	-0	99.4	345.1	191	105	270	0.34	3	3.7	
MC64100EUM-1-V4A	3,730	192,000	270	11,000	-1	99.4	345.1	191	105	270	0.34	3	3.7	
MC64100EUM-2-V4A	3,730	192,000	930	3,700	-2	99.4	345.1	191	105	270	0.34	3	3.7	
MC64100EUM-3-V4A	3,730	192,000	3,150	12,600	-3	99.4	345.1	191	105	270	0.34	3	3.7	
MC64100EUM-4-V4A	3,730	192,000	10,600	42,500	-4	99.4	345.1	191	105	270	0.34	3	3.7	

¹ For emergency use only applications it is sometimes possible to exceed the above ratings. Please consult ACE for further details.

² For applications with higher side load angles consider using the side load adaptor (BV) pages 74 to 77.

MC33-HT to MC64-HT

Extremely heat-resistant at high cycle frequencies

Self-Compensating, use at 0 °C to 150 °C

Energy capacity 170 Nm/Cycle to 3,730 Nm/Cycle

Stroke 23.1 mm to 99.4 mm

Further possibilities of use: Just like all MAGNUM types from the product family MC33 to MC64, the HT (high temperature) industrial shock absorbers are also made from one solid piece. They are characterised by the use of special seals and fluids. This means that these versions can even be used at extreme temperatures of 0 °C to 150 °C in order to safely and reliably damp masses and take away 100 % kinetic energy.

There is no reason why these ready-to-install machine elements should not be used, even under the most unfavourable conditions. Additional benefits are their robust, innovative sealing technology, high energy absorption in a compact design, fixed positive stop and a wide damping range.

Designed for use in extreme temperature ranges, these self-compensating industrial shock absorbers are suitable almost anywhere in plant and mechanical engineering.

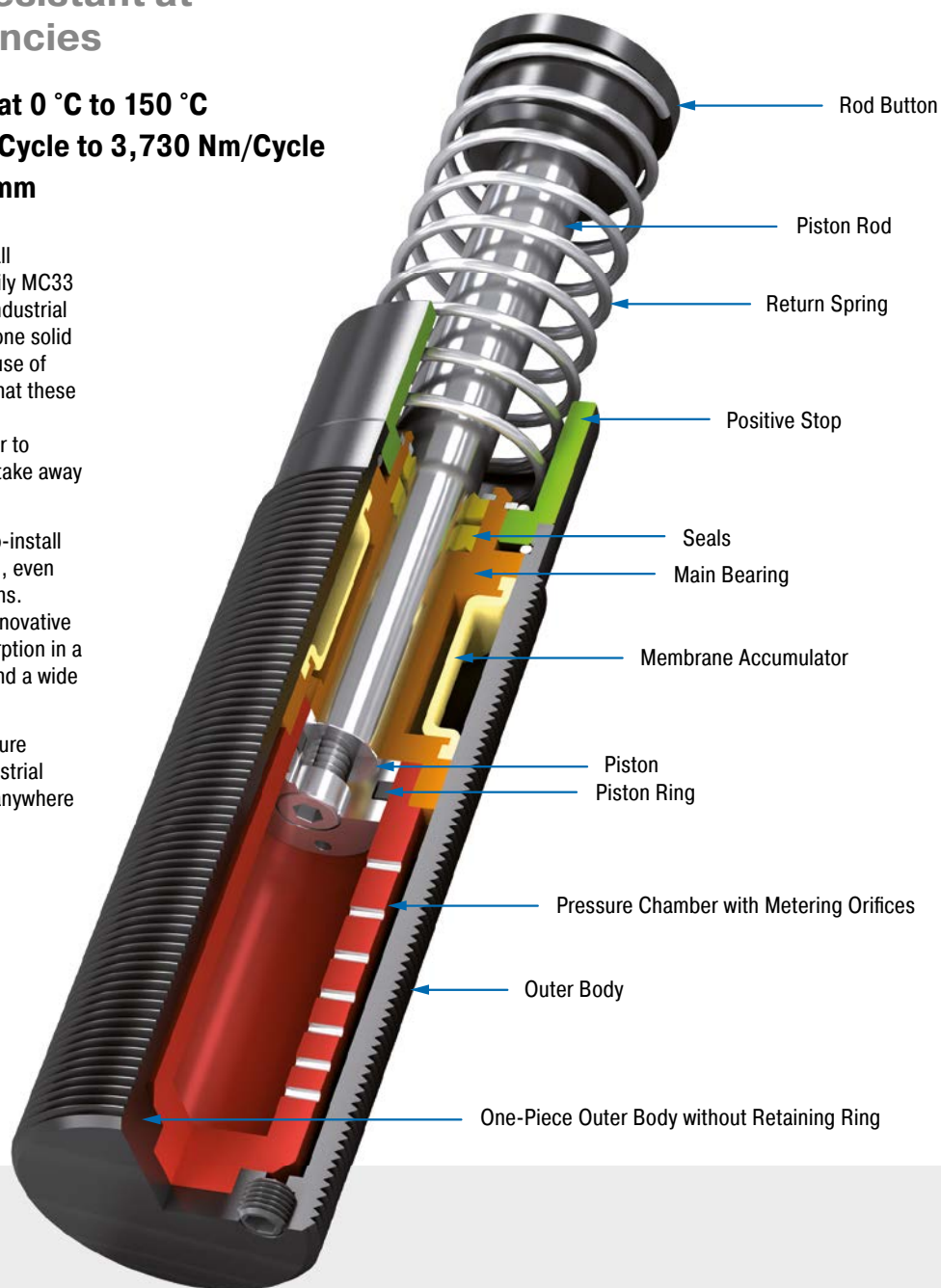

Technical Data

Energy capacity: 170 Nm/Cycle to 3,730 Nm/Cycle

Impact velocity range: 0.15 m/s to 5 m/s.
Other speeds on request.

Operating temperature range: 0 °C to 150 °C

Mounting: In any position

Positive stop: Integrated

Material: Outer body: Nitride hardened steel; Piston rod: Hard chrome plated steel; Rod end button: Hardened steel and corrosion-resistant coating; Return spring: Zinc plated or plastic-coated steel; Accessories: Steel with black oxide finish or nitride hardened

Damping medium: Synthetic high temperature oil

Application field: Linear slides, Swivel units, Turntables, Machines and plants, Tool machines, Machining centres, Z-axes

Note: A noise reduction of 3 to 7 dB is possible when using the special impact button (PP).

Safety instructions: External materials in the surrounding area can attack the seal components and lead to a shorter service life. Please contact ACE for appropriate solution suggestions. Do not paint the shock absorbers due to heat emission.

On request: Nickel-plated, increased corrosion protection, mounting inside air cylinders or other special options are available on request. Adjustable HT and LT shock absorbers.

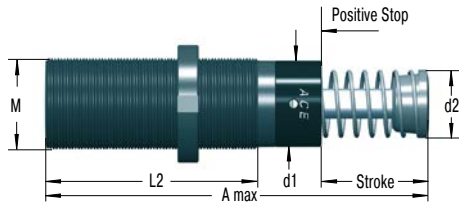
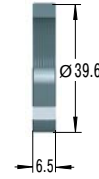
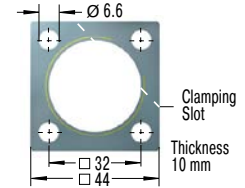
MC33EUM-HT

NM33
Locking Ring

QF33
Square Flange

Torque max.: 11 Nm
Clamping torque: > 90 Nm
Install with 4 machine screws

The calculation and selection of the most suitable damper should be carried out or be approved by ACE.

Complete details required when ordering

- Load to be decelerated: m (kg)
- Impact velocity: v (m/s)
- Propelling force: F (N)
- Operating cycles per hour: c (/hr)
- Number of absorbers in parallel: n
- Ambient temperature: °C

Ordering Example

Self-Compensating _____ **MC3350EUM-2-HT**

Thread Size M33 _____

Stroke 50 mm _____

EU Compliant _____

Metric Thread (omitted when using thread UNF) _____

Effective Weight Range Code _____

HT = Version for High Temperature Use _____

Dimensions							
TYPES	Stroke mm	A max. mm	d1 mm	d2 mm	L2 mm	M	
MC3325EUM-HT	23.2	138	30	25	83	M33x1.5	
MC3350EUM-HT	48.6	189	30	25	108	M33x1.5	

Performance									
TYPES	Max. Energy Capacity			Effective Weight			Hardness	Side Load Angle max. °	Weight kg
	W ₃ Nm/cycle	W ₄ at 20 °C Nm/h	W ₄ at 100 °C Nm/h	¹ me min. kg	¹ me max. kg	² Side Load Angle max.			
MC3325EUM-0-HT	170	215,000	82,000	3	11	-0	4	0.51	
MC3325EUM-1-HT	170	215,000	82,000	9	40	-1	4	0.51	
MC3325EUM-2-HT	170	215,000	82,000	30	120	-2	4	0.51	
MC3325EUM-3-HT	170	215,000	82,000	100	420	-3	4	0.51	
MC3325EUM-4-HT	170	215,000	82,000	350	1,420	-4	4	0.51	
MC3350EUM-0-HT	330	244,000	93,000	5	22	-0	3	0.63	
MC3350EUM-1-HT	330	244,000	93,000	18	70	-1	3	0.63	
MC3350EUM-2-HT	330	244,000	93,000	60	250	-2	3	0.63	
MC3350EUM-3-HT	330	244,000	93,000	240	840	-3	3	0.63	
MC3350EUM-4-HT	330	244,000	93,000	710	2,830	-4	3	0.63	

¹ The effective weight range limits can be raised or lowered to special order.
² For applications with higher side load angles consider using the side load adaptor (BV) pages 74 to 77.

Self-Compensating

MC45EUM-HT

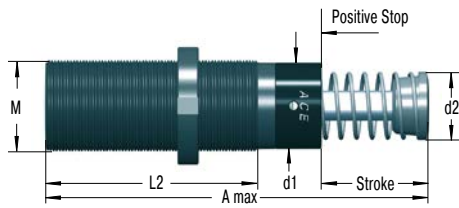

NM45
Locking Ring

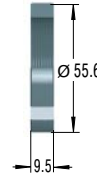

QF45
Square Flange

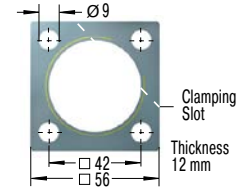

Torque max.: 27 Nm
Clamping torque: > 200 Nm
Install with 4 machine screws

The calculation and selection of the most suitable damper should be carried out or be approved by ACE.

Complete details required when ordering

- Load to be decelerated: m (kg)
- Impact velocity: v (m/s)
- Propelling force: F (N)
- Operating cycles per hour: c (/hr)
- Number of absorbers in parallel: n
- Ambient temperature: °C

Ordering Example

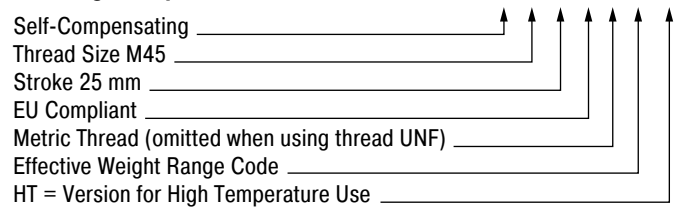

Dimensions

TYPES	Stroke mm	A max. mm	d1 mm	d2 mm	L2 mm	M
MC4525EUM-HT	23.1	145	42	35	95	M45x1.5
MC4550EUM-HT	48.5	195	42	35	120	M45x1.5

Performance

TYPES	Max. Energy Capacity			Effective Weight			Hardness	Side Load Angle max. °	Weight kg
	W ₃ Nm/cycle	W ₄ at 20 °C Nm/h	W ₄ at 100 °C Nm/h	¹ me min. kg	¹ me max. kg	² Side Load Angle max.			
MC4525EUM-0-HT	370	307,000	117,000	7	27	-0	4	1.14	
MC4525EUM-1-HT	370	307,000	117,000	20	90	-1	4	1.14	
MC4525EUM-2-HT	370	307,000	117,000	80	310	-2	4	1.14	
MC4525EUM-3-HT	370	307,000	117,000	260	1,050	-3	4	1.14	
MC4525EUM-4-HT	370	307,000	117,000	890	3,540	-4	4	1.14	
MC4550EUM-0-HT	740	321,000	122,000	13	54	-0	3	1.36	
MC4550EUM-1-HT	740	321,000	122,000	45	180	-1	3	1.36	
MC4550EUM-2-HT	740	321,000	122,000	150	620	-2	3	1.36	
MC4550EUM-3-HT	740	321,000	122,000	520	2,090	-3	3	1.36	
MC4550EUM-4-HT	740	321,000	122,000	1,800	7,100	-4	3	1.36	

¹ The effective weight range limits can be raised or lowered to special order.
² For applications with higher side load angles consider using the side load adaptor (BV) pages 74 to 77.

MC64EUM-HT

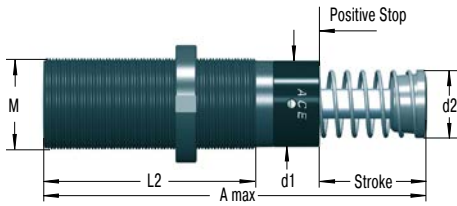

NM64 Locking Ring

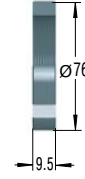

QF64 Square Flange

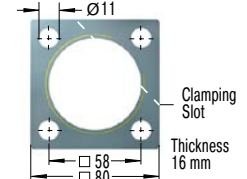

Torque max.: 50 Nm
Clamping torque: > 210 Nm
Install with 4 machine screws

The calculation and selection of the most suitable damper should be carried out or be approved by ACE.

Complete details required when ordering

- Load to be decelerated: m (kg)
- Impact velocity: v (m/s)
- Propelling force: F (N)
- Operating cycles per hour: c (/hr)
- Number of absorbers in parallel: n
- Ambient temperature: °C

Ordering Example

Self-Compensating _____ **MC6450EUM-1-HT**

Thread Size M64 _____

Stroke 50 mm _____

EU Compliant _____

Metric Thread (omitted when using thread UNF) _____

Effective Weight Range Code _____

HT = Version for High Temperature Use _____

Dimensions							
TYPES	Stroke mm	A max. mm	d1 mm	d2 mm	L2 mm	M	
MC6450EUM-HT	48.6	225	60	48	140	M64x2	
MC64100EUM-HT	99.4	326	60	48	191	M64x2	

Performance									
TYPES	Max. Energy Capacity			Effective Weight			Hardness	Side Load Angle max. °	Weight kg
	W ₃ Nm/cycle	W ₄ at 20 °C Nm/h	W ₄ at 100 °C Nm/h	¹ me min. kg	¹ me max. kg				
MC6450EUM-0-HT	1,870	419,000	159,000	35	140	-0	4	2.9	
MC6450EUM-1-HT	1,870	419,000	159,000	140	540	-1	4	2.9	
MC6450EUM-2-HT	1,870	419,000	159,000	460	1,850	-2	4	2.9	
MC6450EUM-3-HT	1,870	419,000	159,000	1,600	6,300	-3	4	2.9	
MC6450EUM-4-HT	1,870	419,000	159,000	5,300	21,200	-4	4	2.9	
MC64100EUM-0-HT	3,730	550,000	200,000	70	280	-0	3	3.7	
MC64100EUM-1-HT	3,730	550,000	200,000	270	1,100	-1	3	3.7	
MC64100EUM-2-HT	3,730	550,000	200,000	930	3,700	-2	3	3.7	
MC64100EUM-3-HT	3,730	550,000	200,000	3,150	12,600	-3	3	3.7	
MC64100EUM-4-HT	3,730	550,000	200,000	10,600	42,500	-4	3	3.7	

¹ The effective weight range limits can be raised or lowered to special order.
² For applications with higher side load angles consider using the side load adaptor (BV) pages 74 to 77.

MC33-LT to MC64-LT

Extremely low temperatures and high cycle frequencies

Self-Compensating, use at -50 °C to +66 °C

Energy capacity 170 Nm/Cycle to 5,650 Nm/Cycle

Stroke 23.1 mm to 150 mm

Further possibilities of use: Just like all MAGNUM types from the product family MC33 to MC64, the LT (low temperature) industrial shock absorbers are also made from one solid piece. They are characterised by the use of special seals and fluids. This means that these versions can even be used at extreme temperatures of -50 °C to +66 °C in order to safely and reliably damp masses and take away 100 % kinetic energy.

There is no reason why these ready-to-install machine elements should not be used, even under the most unfavourable conditions. Additional benefits are their robust, innovative sealing technology, high energy absorption in a compact design, fixed positive stop and a wide damping range.

Designed for use in extreme temperature ranges, these self-compensating industrial shock absorbers are suitable almost anywhere in plant and mechanical engineering.

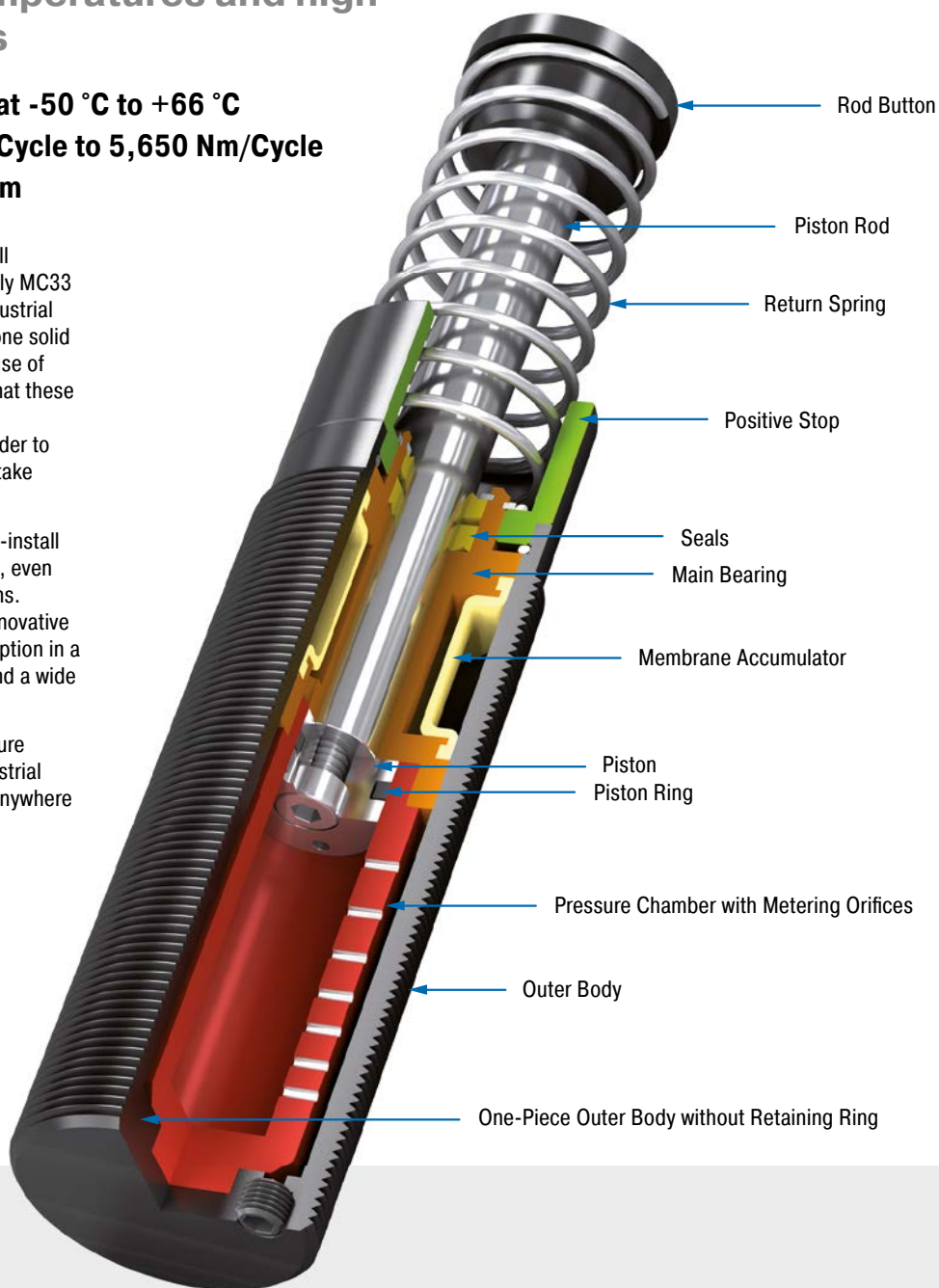

Technical Data

Energy capacity: 170 Nm/Cycle to 5,650 Nm/Cycle

Impact velocity range: 0.15 m/s to 5 m/s.
Other speeds on request.

Operating temperature range: -50 °C to +66 °C

Mounting: In any position

Positive stop: Integrated

Material: Outer body: Nitride hardened steel; Piston rod: Hard chrome plated steel; Rod end button: Hardened steel and corrosion-resistant coating; Return spring: Zinc plated or plastic-coated steel; Accessories: Steel with black oxide finish or nitride hardened

Damping medium: Low temperature hydraulic oil

Application field: Linear slides, Swivel units, Turntables, Machines and plants, Tool machines, Machining centres, Z-axes

Note: A noise reduction of 3 to 7 dB is possible when using the special impact button (PP).

Safety instructions: External materials in the surrounding area can attack the seal components and lead to a shorter service life. Please contact ACE for appropriate solution suggestions. Do not paint the shock absorbers due to heat emission.

On request: Nickel-plated, increased corrosion protection, mounting inside air cylinders or other special options are available on request. Adjustable HT and LT shock absorbers.

MC33EUM-LT

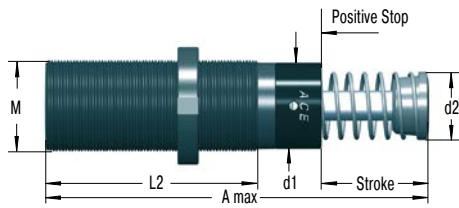

NM33 Locking Ring

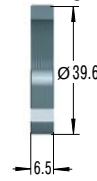

QF33 Square Flange

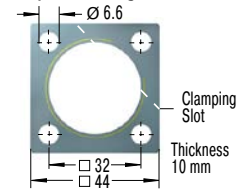

Torque max.: 11 Nm
Clamping torque: > 90 Nm
Install with 4 machine screws

The calculation and selection of the most suitable damper should be carried out or be approved by ACE.

Complete details required when ordering

- Load to be decelerated: m (kg)
- Impact velocity: v (m/s)
- Propelling force: F (N)
- Operating cycles per hour: c (/hr)
- Number of absorbers in parallel: n
- Ambient temperature: °C

Ordering Example

Self-Compensating _____ **MC3325EUM-2-LT**

Thread Size M33 _____

Stroke 25 mm _____

EU Compliant _____

Metric Thread (omitted when using thread UNF) _____

Effective Weight Range Code _____

LT = Version for Low Temperature Use _____

Dimensions

TYPES	Stroke mm	A max. mm	d1 mm	d2 mm	L2 mm	M
MC3325EUM-LT	23.2	138	30	25	83	M33x1.5
MC3350EUM-LT	48.6	189	30	25	108	M33x1.5

Performance

TYPES	Max. Energy Capacity		Effective Weight			Return Time s	Side Load Angle max. °	Weight kg
	W ₂ Nm/cycle	W ₄ Nm/h	¹ me min. kg	¹ me max. kg	Hardness			
MC3325EUM-0-LT	170	75,000	3	11	-0	0.08	4	0.51
MC3325EUM-1-LT	170	75,000	9	40	-1	0.08	4	0.51
MC3325EUM-2-LT	170	75,000	30	120	-2	0.08	4	0.51
MC3325EUM-3-LT	170	75,000	100	420	-3	0.08	4	0.51
MC3325EUM-4-LT	170	75,000	350	1,420	-4	0.08	4	0.51
MC3350EUM-0-LT	330	85,000	5	22	-0	0.16	3	0.63
MC3350EUM-1-LT	330	85,000	18	70	-1	0.16	3	0.63
MC3350EUM-2-LT	330	85,000	60	250	-2	0.16	3	0.63
MC3350EUM-3-LT	330	85,000	240	840	-3	0.16	3	0.63
MC3350EUM-4-LT	330	85,000	710	2,830	-4	0.16	3	0.63

¹ The effective weight range limits can be raised or lowered to special order.

² at -50 °C

³ For applications with higher side load angles consider using the side load adaptor (BV) pages 74 to 77.

Self-Compensating

MC45EUM-LT

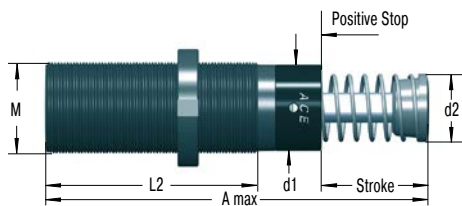

NM45 Locking Ring

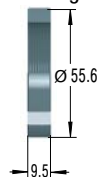

QF45 Square Flange

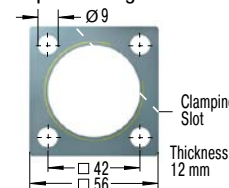

Torque max.: 27 Nm
Clamping torque: > 200 Nm
Install with 4 machine screws

The calculation and selection of the most suitable damper should be carried out or be approved by ACE.

Complete details required when ordering

- Load to be decelerated: m (kg)
- Impact velocity: v (m/s)
- Propelling force: F (N)
- Operating cycles per hour: c (/hr)
- Number of absorbers in parallel: n
- Ambient temperature: °C

Ordering Example

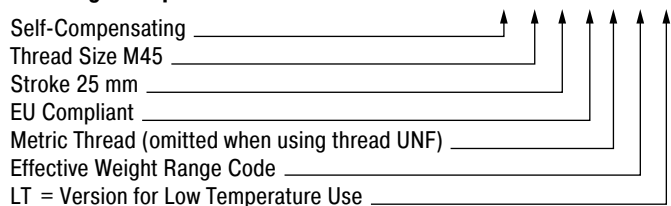

Dimensions

TYPES	Stroke mm	A max. mm	d1 mm	d2 mm	L2 mm	M
MC4525EUM-LT	23.1	145	42	35	95	M45x1.5
MC4550EUM-LT	48.5	195	42	35	120	M45x1.5
MC4575EUM-LT	73.9	246	42	35	145	M45x1.5

Performance

TYPES	Max. Energy Capacity		Effective Weight			Return Time s	Side Load Angle max. °	Weight kg
	W ₀ Nm/cycle	W ₄ Nm/h	¹ me min. kg	¹ me max. kg	Hardness			
MC4525EUM-0-LT	370	107,000	7	27	-0	0.08	4	1.14
MC4525EUM-1-LT	370	107,000	20	90	-1	0.08	4	1.14
MC4525EUM-2-LT	370	107,000	80	310	-2	0.08	4	1.14
MC4525EUM-3-LT	370	107,000	260	1,050	-3	0.08	4	1.14
MC4525EUM-4-LT	370	107,000	890	3,540	-4	0.08	4	1.14
MC4550EUM-0-LT	740	112,000	13	54	-0	0.16	3	1.36
MC4550EUM-1-LT	740	112,000	45	180	-1	0.16	3	1.36
MC4550EUM-2-LT	740	112,000	150	620	-2	0.16	3	1.36
MC4550EUM-3-LT	740	112,000	520	2,090	-3	0.16	3	1.36
MC4550EUM-4-LT	740	112,000	1,800	7,100	-4	0.16	3	1.36
MC4575EUM-0-LT	1,130	146,000	20	80	-0	0.24	2	1.59
MC4575EUM-1-LT	1,130	146,000	20	80	-1	0.24	2	1.59
MC4575EUM-2-LT	1,130	146,000	70	270	-2	0.24	2	1.59
MC4575EUM-3-LT	1,130	146,000	230	930	-3	0.24	2	1.59
MC4575EUM-4-LT	1,130	146,000	2,650	10,600	-4	0.24	2	1.59

¹ The effective weight range limits can be raised or lowered to special order.
² at -50 °C
³ For applications with higher side load angles consider using the side load adaptor (BV) pages 74 to 77.

MC64EUM-LT

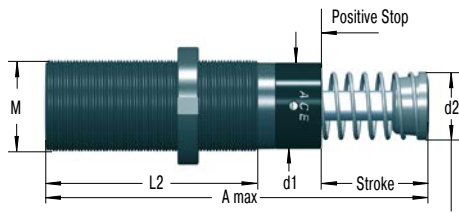

150 mm stroke model does not include stop collar.
Positive stop is provided by the rod button (Ø 60 mm) and a stop block.

NM64 Locking Ring

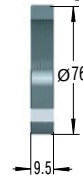

QF64 Square Flange

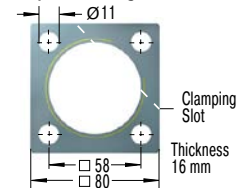

Torque max.: 50 Nm
Clamping torque: > 210 Nm
Install with 4 machine screws

The calculation and selection of the most suitable damper should be carried out or be approved by ACE.

Complete details required when ordering

- Load to be decelerated: m (kg)
- Impact velocity: v (m/s)
- Propelling force: F (N)
- Operating cycles per hour: c (/hr)
- Number of absorbers in parallel: n
- Ambient temperature: °C

Ordering Example

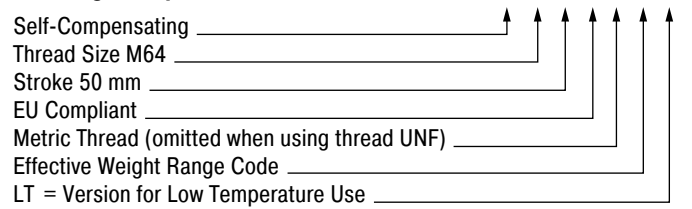

Dimensions							
TYPES	Stroke mm	A max. mm	d1 mm	d2 mm	L2 mm	M	
MC6450EUM-LT	48.6	225	60	48	140	M64x2	
MC64100EUM-LT	99.4	326	60	48	191	M64x2	
MC64150EUM-LT	150	450	60	48	241	M64x2	

Performance								
TYPES	Max. Energy Capacity		Effective Weight			² Return Time s	³ Side Load Angle max. °	Weight kg
	W ₃ Nm/cycle	W ₄ Nm/h	¹ me min. kg	¹ me max. kg	Hardness			
MC6450EUM-0-LT	1,870	146,000	35	140	-0	0.24	4	2.9
MC6450EUM-1-LT	1,870	146,000	140	540	-1	0.24	4	2.9
MC6450EUM-2-LT	1,870	146,000	460	1,850	-2	0.24	4	2.9
MC6450EUM-3-LT	1,870	146,000	1,600	6,300	-3	0.24	4	2.9
MC6450EUM-4-LT	1,870	146,000	5,300	21,200	-4	0.24	4	2.9
MC64100EUM-0-LT	3,730	192,000	70	280	-0	0.68	3	3.7
MC64100EUM-1-LT	3,730	192,000	270	1,100	-1	0.68	3	3.7
MC64100EUM-2-LT	3,730	192,000	930	3,700	-2	0.68	3	3.7
MC64100EUM-3-LT	3,730	192,000	3,150	12,600	-3	0.68	3	3.7
MC64100EUM-4-LT	3,730	192,000	10,600	42,500	-4	0.68	3	3.7
MC64150EUM-0-LT	5,650	248,000	100	460	-0	0.96	2	5.1
MC64150EUM-1-LT	5,650	248,000	410	1,640	-1	0.96	2	5.1
MC64150EUM-2-LT	5,650	248,000	1,390	5,600	-2	0.96	2	5.1
MC64150EUM-3-LT	5,650	248,000	4,700	18,800	-3	0.96	2	5.1
MC64150EUM-4-LT	5,650	248,000	16,000	63,700	-4	0.96	2	5.1

¹ The effective weight range limits can be raised or lowered to special order.
² at -50 °C
³ For applications with higher side load angles consider using the side load adaptor (BV) pages 74 to 77.

Issue 07.2017 – Specifications subject to change

SC33 to SC45

Piston tube design for maximum energy absorption

Self-Compensating, Piston Tube Technology

Energy capacity 155 Nm/Cycle to 680 Nm/Cycle

Stroke 23.1 mm to 48.6 mm

True performers: The combination of the proven sealing technology from the MAGNUM range including membrane accumulator with the well-known piston tube technology from the SC² family makes the SC33 to 45 absorber models so strong and durable. The increase of the oil volume ensures the maximum effective weights. Short stroke lengths of 25 mm to 50 mm lead to shorter braking times in combination with a high energy absorption.

These dampers safely and reliably decelerate rotary movements without unwanted recoil effects. Assembly close to the pivot point is possible. The low impact speeds with this are managed with ease by ACE's generation of piston tubes.

These self-compensating industrial shock absorbers can be relied on in mechanical engineering. They are used in pivot units, rotary tables, robot arms or integrated elsewhere in construction designs.

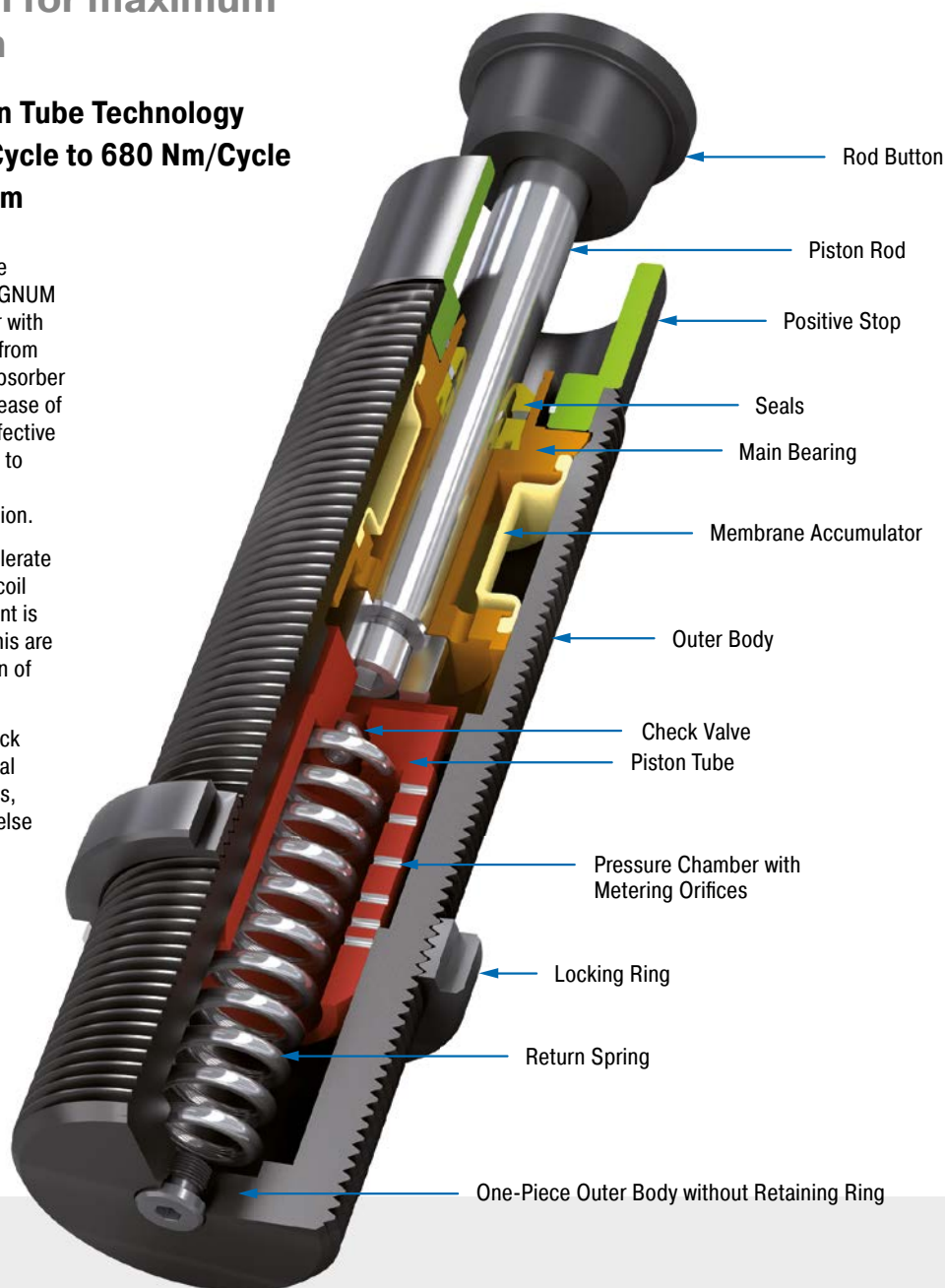

Technical Data

Energy capacity: 155 Nm/Cycle to 680 Nm/Cycle

Impact velocity range: 0.02 m/s to 0.46 m/s. Other speeds on request.

Operating temperature range: -12 °C to +66 °C. Other temperatures on request.

Mounting: In any position

Positive stop: In any position

Material: Outer body: Nitride hardened steel; Piston rod: Hard chrome plated steel; Rod end button: Hardened steel and corrosion-resistant coating; Accessories: Steel with black oxide finish or nitride hardened

Damping medium: Low temperature hydraulic oil

Application field: Turntables, Swivel units, Robot arms, Linear slides, Pneumatic cylinders, Handling modules, Machines and plants, Finishing and processing centres

Note: A noise reduction of 3 to 7 dB is possible when using the special impact button (PP).

Safety instructions: External materials in the surrounding area can attack the seal components and lead to a shorter service life. Please contact ACE for appropriate solution suggestions. Do not paint the shock absorbers due to heat emission.

On request: Special oils, mounting inside air cylinders or other special options are available on request.

SC33EUM

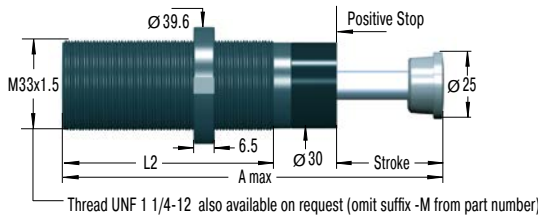

NM33 Locking Ring

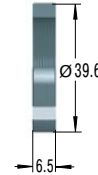

QF33 Square Flange

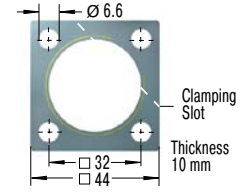

Torque max.: 11 Nm
Clamping torque: > 90 Nm
Install with 4 machine screws

SC45EUM

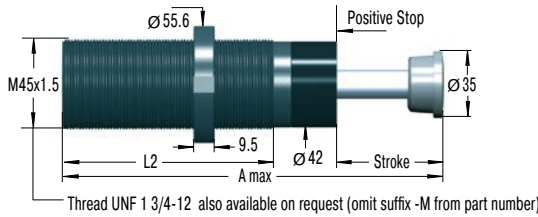

NM45 Locking Ring

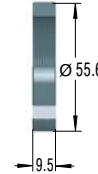

QF45 Square Flange

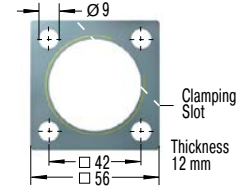

Torque max.: 27 Nm
Clamping torque: > 200 Nm
Install with 4 machine screws

The calculation and selection of the most suitable damper should be carried out or be approved by ACE.

Ordering Example

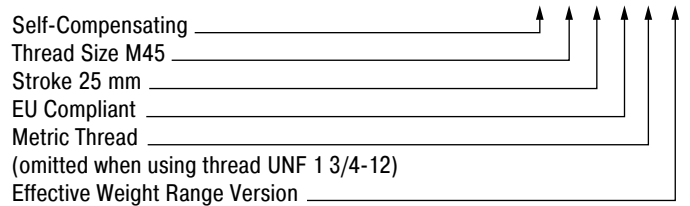

Dimensions

TYPES	Stroke mm	A max. mm	L2 mm
SC3325EUM	23.2	178	122
SC3350EUM	48.6	254	173
SC4525EUM	23.1	189	139
SC4550EUM	48.5	265	190

Performance

TYPES	Max. Energy Capacity		Effective Weight			Return Force min. N	Return Force max. N	Return Time s	Side Load Angle max. °	Weight kg
	W ₃ Nm/cycle	W ₄ Nm/h	¹ me min. kg	¹ me max. kg	Hardness					
SC3325EUM-5	155	75,000	1,360	2,721	-5	44	89	0.75	4	0.68
SC3325EUM-6	155	75,000	2,500	5,443	-6	44	89	0.75	4	0.68
SC3325EUM-7	155	75,000	4,989	8,935	-7	44	89	0.75	4	0.68
SC3325EUM-8	155	75,000	8,618	13,607	-8	44	89	0.75	4	0.68
SC3350EUM-5	310	85,000	2,721	4,990	-5	51	125	0.90	3	0.92
SC3350EUM-6	310	85,000	4,536	9,980	-6	51	125	0.90	3	0.92
SC4525EUM-5	340	107,000	3,400	6,800	-5	67	104	0.8	4	1.43
SC4525EUM-6	340	107,000	6,350	13,600	-6	67	104	0.8	4	1.43
SC4525EUM-7	340	107,000	12,700	22,679	-7	67	104	0.8	4	1.43
SC4525EUM-8	340	107,000	20,411	39,000	-8	67	104	0.8	4	1.43
SC4550EUM-5	680	112,000	6,800	12,246	-5	47	242	1.0	3	1.90
SC4550EUM-6	680	112,000	11,790	26,988	-6	47	242	1.0	3	1.90
SC4550EUM-7	680	112,000	25,854	44,225	-7	47	242	1.0	3	1.90

¹ The effective weight range limits can be raised or lowered to special order.

² For applications with higher side load angles consider using the side load adaptor (BV) pages 74 to 77.

MA/ML33 to MA/ML64

High energy absorption and progressive adjustment

Adjustable

Energy capacity 170 Nm/Cycle to 6,780 Nm/Cycle
Stroke 23.1 mm to 150 mm

Adjustable and unique: These industrial shock absorbers from ACE, which can be precisely adjusted both at the front and rear, also contribute towards the success of the MAGNUM series. Equipped with excellent sealing technology, an annealed guide bearing and integrated positive stop, they are robust and durable.

These dampers absorb 50 % more energy than their predecessors but are built even more compactly. The larger range of effective loads also opens up various options in design and assembly. This makes the ML series especially suitable for effective loads of 300 kg to 500,000 kg. Where work is done with changing application data and wherever flexibility is required, they make the best option.

These adjustable industrial shock absorbers are used in all areas of mechanical engineering - e.g. in automation, integrated in linear carriages or pivoting units and also for gantries.

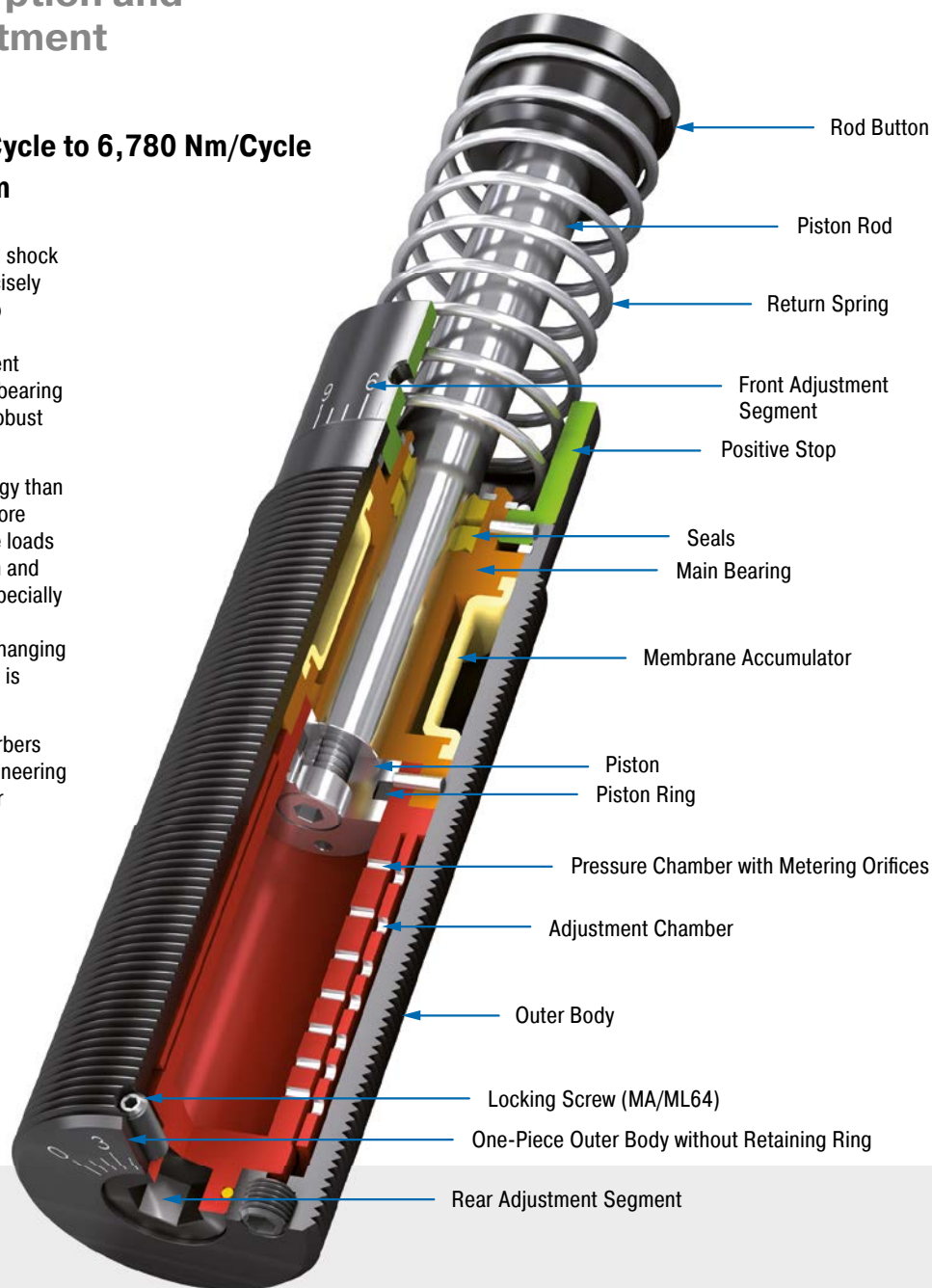

Technical Data

Energy capacity: 170 Nm/Cycle to 6,780 Nm/Cycle

Impact velocity range: MA: 0.15 m/s to 5 m/s. ML: 0.02 m/s to 0.46 m/s. Other speeds on request.

Operating temperature range: -12 °C to +66 °C

Other temperatures on request.

Mounting: In any position

Positive stop: Integrated

Adjustment: Hard impact at the start of stroke, adjust the ring towards 9 or PLUS. Hard impact at the end of stroke, adjust the ring towards 0 or MINUS.

Material: Outer body: Nitride hardened steel; Piston rod: Hard chrome plated steel; Rod end button: Hardened steel and corrosion-resistant coating; Return spring: Zinc plated or plastic-coated steel; Accessories: Steel with black oxide finish or nitride hardened

Damping medium: Automatic Transmission Fluid (ATF)

Application field: Linear slides, Swivel units, Turntables, Portal systems, Machines and plants, Tool machines, Machining centres, Z-axes, Impact panels

Note: A noise reduction of 3 to 7 dB is possible when using the special impact button (PP). For emergency use only applications and

for continuous use (with additional cooling) it is sometimes possible to exceed the published max. capacity ratings. In this case, please consult ACE.

Safety instructions: External materials in the surrounding area can attack the seal components and lead to a shorter service life. Please contact ACE for appropriate solution suggestions. Do not paint the shock absorbers due to heat emission.

On request: Special oils, nickel-plated, increased corrosion protection, mounting inside air cylinders or other special options are available on request.

MA/ML33EUM

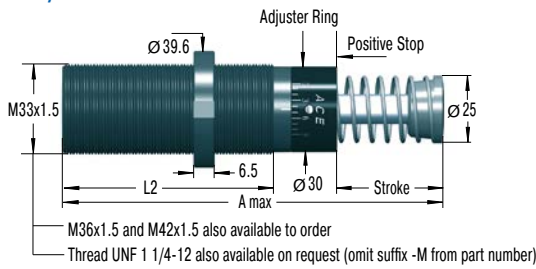

NM33 Locking Ring

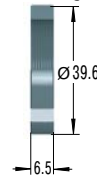

QF33 Square Flange

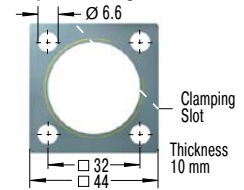

Torque max.: 11 Nm
Clamping torque: > 90 Nm
Install with 4 machine screws

The calculation and selection of the most suitable damper should be carried out or be approved by ACE.

Model Type Prefix

Standard Models

- MA: Self-Contained with return spring, adjustable
- ML: Self-Contained with return spring, adjustable, for lower impact velocity

Special Models

- MAA, MLA: Air/Oil return without return spring. Use only with external air/oil tank.
- MAS, MLS: Air/Oil Return with return spring. Use only with external air/oil tank.
- MAN, MLN: Self-Contained without return spring

Ordering Example

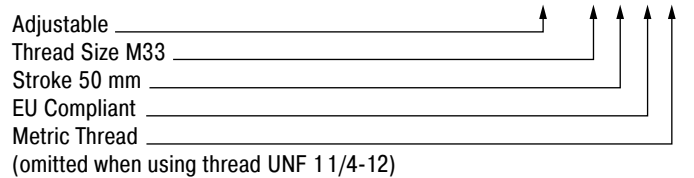

Dimensions

TYPES	Stroke mm	A max. mm	L2 mm
MA3325EUM	23.2	138	83
ML3325EUM	23.2	138	83
MA3350EUM	48.6	189	108
ML3350EUM	48.6	189	108

Performance

TYPES	Max. Energy Capacity				Effective Weight		Return Force min. N	Return Force max. N	Return Time s	Side Load Angle max. °	Weight kg
	¹ W ₃ Nm/cycle	W ₄ Nm/h	W ₄ with Air/Oil Tank Nm/h	W ₄ with Oil Recirculation Nm/h	² me min. kg	² me max. kg					
MA3325EUM	170	75,000	124,000	169,000	9	1,700	45	90	0.03	4	0.51
ML3325EUM	170	75,000	124,000	169,000	300	50,000	45	90	0.03	4	0.51
MA3350EUM	340	85,000	135,000	180,000	13	2,500	45	135	0.06	3	0.62
ML3350EUM	340	85,000	135,000	180,000	500	80,000	45	135	0.06	3	0.62

¹ For emergency use only applications it is sometimes possible to exceed the above ratings. Please consult ACE for further details.

² The effective weight range limits can be raised or lowered to special order.

³ For applications with higher side load angles consider using the side load adaptor (BV) pages 74 to 77.

Adjustable

MA/ML45EUM

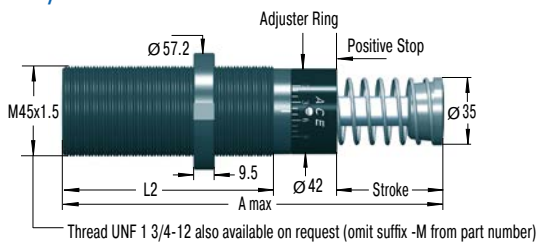

NM45
Locking Ring

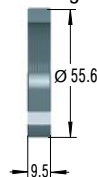

QF45
Square Flange

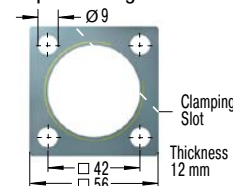

Torque max.: 27 Nm
Clamping torque: > 200 Nm
Install with 4 machine screws

The calculation and selection of the most suitable damper should be carried out or be approved by ACE.

Model Type Prefix

Standard Models

- MA: Self-Contained with return spring, adjustable
- ML: Self-Contained with return spring, adjustable, for lower impact velocity

Special Models

- MAA, MLA: Air/Oil return without return spring. Use only with external air/oil tank.
- MAS, MLS: Air/Oil Return with return spring. Use only with external air/oil tank.
- MAN, MLN: Self-Contained without return spring

Ordering Example

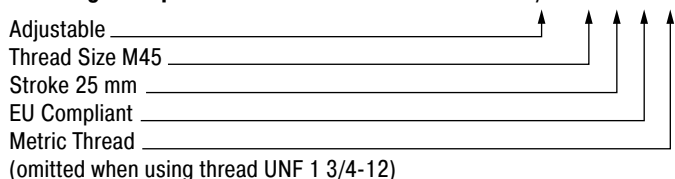

Dimensions			
TYPES	Stroke mm	A max. mm	L2 mm
MA4525EUM	23.1	145	95
ML4525EUM	23.1	145	95
MA4550EUM	48.5	195	120
ML4550EUM	48.5	195	120
MA4575EUM	73.9	246	145

Performance											
TYPES	Max. Energy Capacity				Effective Weight		Return Force min. N	Return Force max. N	Return Time s	Side Load Angle max. °	Weight kg
	¹ W ₃ Nm/cycle	W ₄ Nm/h	W ₄ with Air/Oil Tank Nm/h	W ₄ with Oil Recirculation Nm/h	² me min. kg	² me max. kg					
MA4525EUM	425	107,000	158,000	192,000	40	10,000	70	100	0.03	4	1.13
ML4525EUM	425	107,000	158,000	192,000	3,000	110,000	70	100	0.03	4	1.13
MA4550EUM	850	112,000	192,000	248,000	70	14,500	70	145	0.08	3	1.37
ML4550EUM	850	112,000	192,000	248,000	5,000	180,000	70	145	0.08	3	1.37
MA4575EUM	1,300	146,000	225,000	282,000	70	15,000	50	180	0.11	2	1.59

¹ For emergency use only applications it is sometimes possible to exceed the above ratings. Please consult ACE for further details.
² The effective weight range limits can be raised or lowered to special order.
³ For applications with higher side load angles consider using the side load adaptor (BV) pages 74 to 77.

MA/ML64EUM

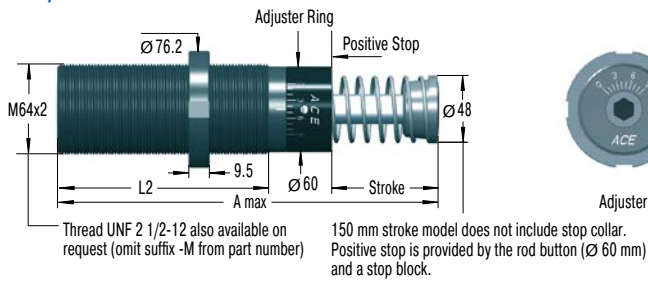

NM64 Locking Ring

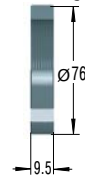

QF64 Square Flange

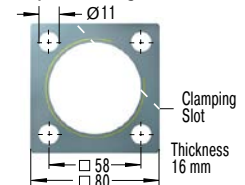

Torque max.: 50 Nm
Clamping torque: > 210 Nm
Install with 4 machine screws

The calculation and selection of the most suitable damper should be carried out or be approved by ACE.

Model Type Prefix

Standard Models

- MA: Self-Contained with return spring, adjustable
- ML: Self-Contained with return spring, adjustable, for lower impact velocity

Special Models

- MAA, MLA: Air/Oil return without return spring. Use only with external air/oil tank.
- MAS, MLS: Air/Oil Return with return spring. Use only with external air/oil tank.
- MAN, MLN: Self-Contained without return spring

Ordering Example

Adjustable _____ **MA/ML6450EUM**

Thread Size M64 _____

Stroke 50 mm _____

EU Compliant _____

Metric Thread _____

(omitted when using thread UNF 2 1/2-12)

Dimensions

TYPES	Stroke mm	A max. mm	L2 mm
ML6425EUM	23.2	174	114
MA6450EUM	48.6	225	140
ML6450EUM	48.6	225	140
MA64100EUM	99.4	326	191
MA64150EUM	150	450	241

Performance

TYPES	Max. Energy Capacity				Effective Weight		Return Force min. N	Return Force max. N	Return Time s	Side Load Angle max. °	Weight kg
	¹ W ₃ Nm/cycle	W ₄ Nm/h	W ₄ with Air/Oil Tank Nm/h	W ₄ with Oil Recirculation Nm/h	² me min. kg	² me max. kg					
ML6425EUM	1,135	124,000	248,000	332,000	7,000	300,000	120	155	0.06	5	2.5
MA6450EUM	2,275	146,000	293,000	384,000	220	50,000	90	155	0.12	4	3.0
ML6450EUM	2,275	146,000	293,000	384,000	11,000	500,000	90	155	0.12	4	3.0
MA64100EUM	4,520	192,000	384,000	497,000	270	52,000	105	270	0.34	3	3.7
MA64150EUM	6,780	248,000	497,000	644,000	330	80,000	75	365	0.48	2	5.1

¹ For emergency use only applications it is sometimes possible to exceed the above ratings. Please consult ACE for further details.

² The effective weight range limits can be raised or lowered to special order.

³ For applications with higher side load angles consider using the side load adaptor (BV) pages 74 to 77.

M33x1.5

S33 Side Foot Mounting Kit

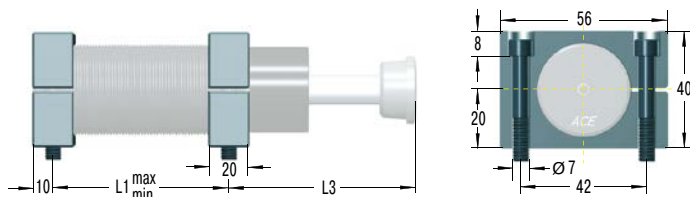

TYPES	L1 min.		L1 max.	L3
	mm	mm	mm	mm
MC, MA, ML3325EUM	25	60	68	
MC, MA, ML3350EUM	32	86	93	
SC3325EUM	40	98	66	
SC3350EUM	60	153	92	

S33 = 2 flanges + 4 screws M6x40, DIN 912
 Torque max.: 11 Nm
 Clamping torque: 90 Nm
 Because of the thread pitch the fixing holes for the second foot mount should only be drilled and tapped after the first foot mount has been fixed in position.

C33 Clevis Mounting Kit

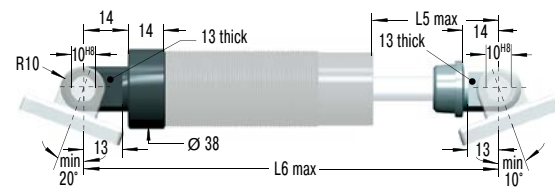

TYPES	L5 max.	L6 max.
	mm	mm
MC, MA, ML3325EUM	39	168
MC, MA, ML3350EUM	64	218
SC3325EUM	39	208
SC3350EUM	64	283

C33 = 2 clevis eyes. Delivered assembled to shock absorber.
 Use positive stop at both ends of travel.

SF33 Clevis Flange

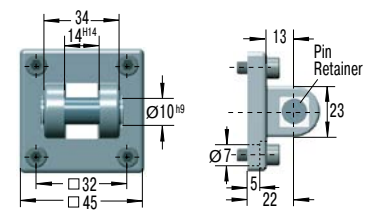

SF33 = flange + 4 screws M6x20, DIN 912
 Torque max.: 7.5 Nm
 Clamping torque: > 50 Nm
Secure with pin or use additional bar.
Due to limited force capacity the respective ability should be reviewed by ACE.

M33x1.5

NM33 Locking Ring

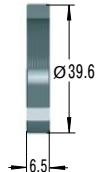

PP33 Poly Button

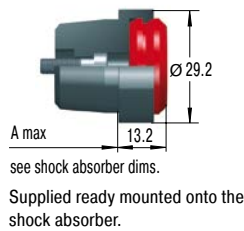

QF33 Square Flange

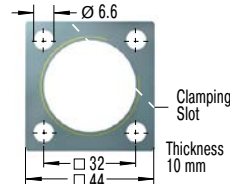

Torque max.: 11 Nm
 Clamping torque: > 90 Nm
 Install with 4 machine screws

AS33 Switch Stop Collar

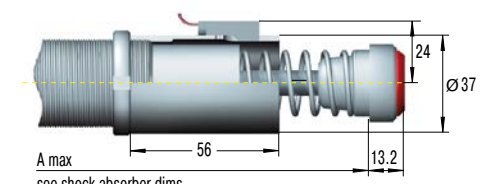

inc. Proximity Switch and Poly Button with elastomer insert

BV3325 Side Load Adaptor

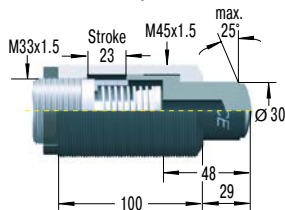

BV3350 Side Load Adaptor

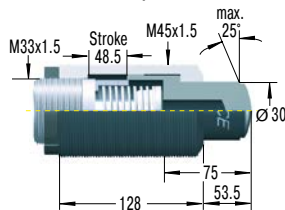

PB3325 Steel Shroud

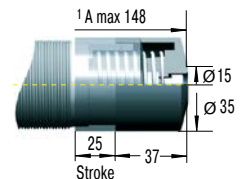

¹ Total installation length of the shock absorber inc. steel shroud

PB3350 Steel Shroud

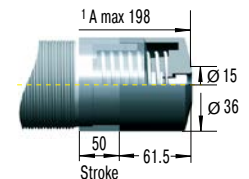

¹ Total installation length of the shock absorber inc. steel shroud

For mounting, installation, ..., see page 77.

M45x1.5

S45 Side Foot Mounting Kit

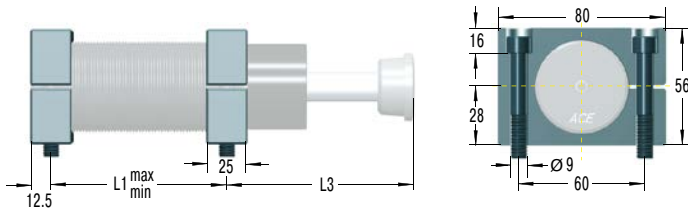

Dimensions

TYPES	L1 min. mm	L1 max. mm	L3 mm
MC, MA, ML4525EUM	32	66	66
MC, MA, ML4550EUM	40	92	91
MC, MA4575EUM	50	118	116
SC4525EUM	50	112	62.5
SC4550EUM	64	162	87.5

S45 = 2 flanges + 4 screws M8x50, DIN 912

Torque max.: 27 Nm

Clamping torque: 350 Nm

Because of the thread pitch the fixing holes for the second foot mount should only be drilled and tapped after the first foot mount has been fixed in position.

C45 Clevis Mounting Kit

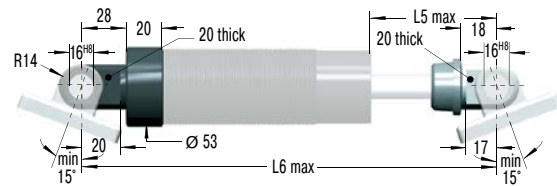

Dimensions

TYPES	L5 max. mm	L6 max. mm
MC, MA, ML4525EUM	43	200
MC, MA, ML4550EUM	68	250
MC, MA4575EUM	93	301
SC4525EUM	68	244
SC4550EUM	93	320

C45 = 2 clevis eyes. Delivered assembled to shock absorber.

Use positive stop at both ends of travel.

SF45 Clevis Flange

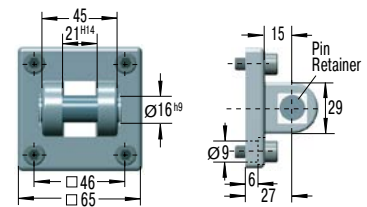

SF45 = flange + 4 screws M8x20, DIN 912

Torque max.: 7.5 Nm

Clamping torque: > 140 Nm

Secure with pin or use additional bar.

Due to limited force capacity the respective ability should be reviewed by ACE.

M45x1.5

NM45 Locking Ring

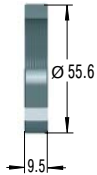

PP45 Poly Button

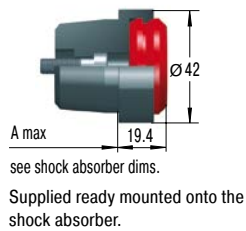

QF45 Square Flange

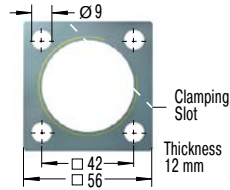

Torque max.: 27 Nm
Clamping torque: > 200 Nm
Install with 4 machine screws

AS45 Switch Stop Collar

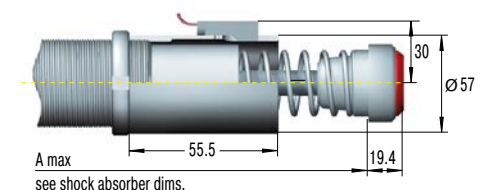

inc. Proximity Switch and Poly Button with elastomer insert

BV4525 Side Load Adaptor

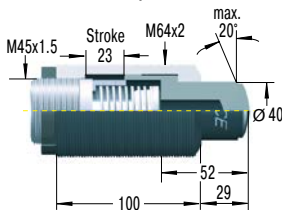

BV4550 Side Load Adaptor

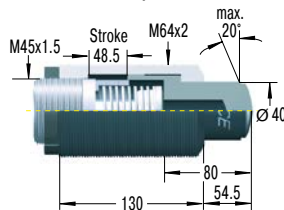

PB4525 Steel Shroud

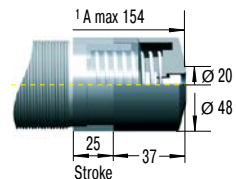

¹ Total installation length of the shock absorber inc. steel shroud

PB4550 Steel Shroud

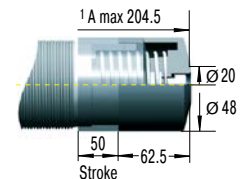

¹ Total installation length of the shock absorber inc. steel shroud

M64x2

S64 Side Foot Mounting Kit

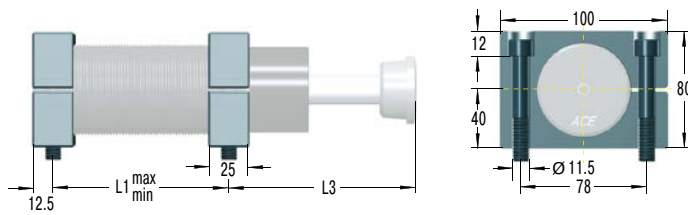

Dimensions			
TYPES	L1 min. mm	L1 max. mm	L3 mm
ML6425EUM	40	86	75.5
MC, MA, ML6450EUM	50	112	100
MC, MA64100EUM	64	162	152
MC, MA64150EUM	80	212	226

S64 = 2 flanges + 4 screws M10x80, DIN 912
 Torque max.: 50 Nm
 Clamping torque: 350 Nm
 Because of the thread pitch the fixing holes for the second foot mount should only be drilled and tapped after the first foot mount has been fixed in position.

C64 Clevis Mounting Kit

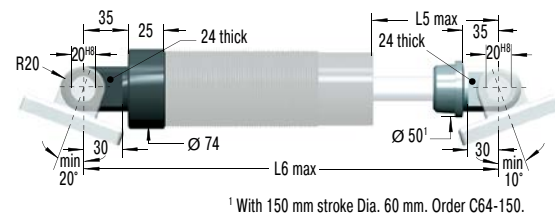

Dimensions		
TYPES	L5 max. mm	L6 max. mm
ML6425EUM	60	260
MC, MA, ML6450EUM	85	310
MC, MA64100EUM	136	410
MC, MA64150EUM	187	530

C64 = 2 clevis eyes. Delivered assembled to shock absorber.
 Use positive stop at both ends of travel.

SF64 Clevis Flange

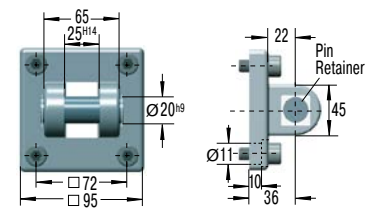

SF64 = flange + 4 screws M10x20, DIN 912
 Torque max.: 15 Nm
 Clamping torque: > 200 Nm
Secure with pin or use additional bar.
Due to limited force capacity the respective ability should be reviewed by ACE.

M64x2

NM64 Locking Ring

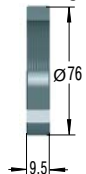

PP64 Poly Button

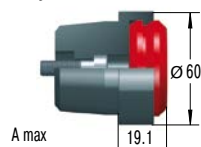

see shock absorber dims.
 Supplied ready mounted onto the shock absorber.

QF64 Square Flange

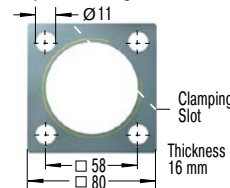

Torque max.: 50 Nm
 Clamping torque: > 210 Nm
 Install with 4 machine screws

QF90 Square Flange

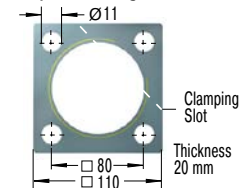

Torque max.: 50 Nm
 Clamping torque: > 210 Nm
 Install with 4 machine screws

BV6425 Side Load Adaptor

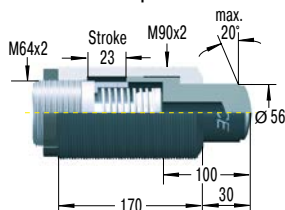

BV6450 Side Load Adaptor

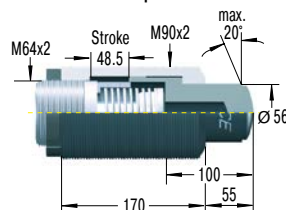

PB6425 Steel Shroud

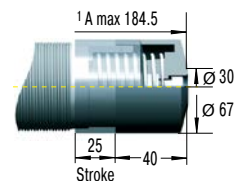

¹ Total installation length of the shock absorber inc. steel shroud

PB6450 Steel Shroud

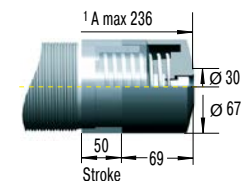

¹ Total installation length of the shock absorber inc. steel shroud

For mounting, installation, ..., see page 77.

BV

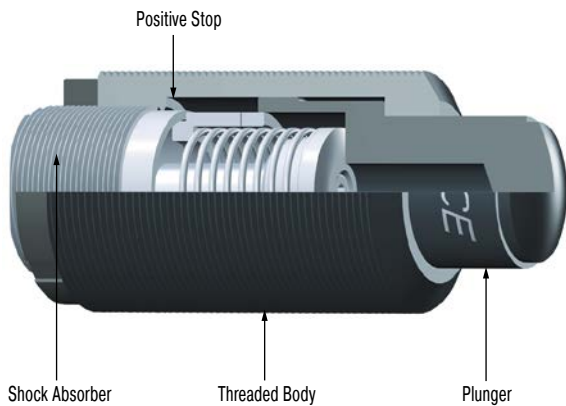

Side Load Adaptor

For side load impact angles from 3° to 25°

With side load impact angles of more than 3° the operation lifetime of the shock absorber reduces rapidly due to increased wear of rod bearings. The optional BV side load adaptor provides long lasting solution.

Ordering information

- BV3325** (M45x1.5) for MC, MA, ML3325EUM (M33x1.5)
- BV3350** (M45x1.5) for MC, MA, ML3350EUM (M33x1.5)
- BV4525** (M64x2) for MC, MA, ML4525EUM (M45x1.5)
- BV4550** (M64x2) for MC, MA, ML4550EUM (M45x1.5)
- BV6425** (M90x2) for ML6425EUM (M64x2)
- BV6450** (M90x2) for MC, MA, ML6450EUM (M64x2)

Material

Threaded body and plunger: Hardened high tensile steel, hardened 610 HV1

Mounting information

Directly mount the shock absorber/side mount assembly on the outside thread of the side load adaptor or by using the QF flange. You cannot use a foot mount.

Calculation example and installation hints see page 45.

PB

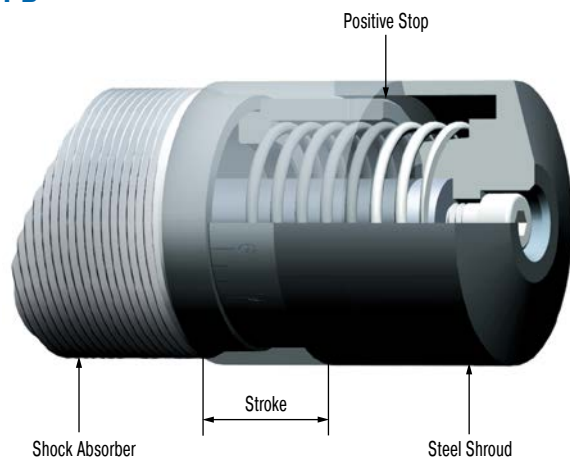

Steel Shroud

For thread sizes M33x1.5, M45x1.5 and M64x2 with 25 or 50 mm stroke.

Grinding beads, sand, welding splatter, paints and adhesives etc. can adhere to the piston rod. They then damage the rod seals and the shock absorber quickly fails. In many cases the installation of the optional steel shroud can provide worthwhile protection and increase lifetime.

Material

Hardened high tensile steel

Mounting information

To mount the PB steel shroud it is necessary to remove the rod end button of the shock absorber.

Safety instructions

When installing don't forget to allow operating space for the shroud to move as the shock absorber is cycled.

AS

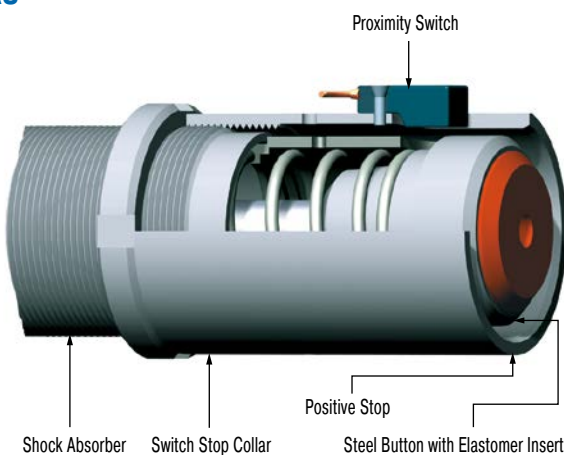

Switch Stop Collar

For thread sizes M33x1.5 and M45x1.5

The ACE stop light switch stop collar combination serves as a safety element to provide stroke position information for automatically sequenced machines. The compact construction allows its use in nearly any application. The standard rod button is detected by the proximity switch at the end of its stroke to provide switch actuation. The switch is normally open when the shock absorber is extended and only closes when it has completed its operating stroke.

Material

Hardened high tensile steel

Delivery

The AS switch stop collar combination is only delivered ready mounted onto the shock absorber c/w the switch.

For circuit diagram of proximity switch see page 46.

Application Examples

MC33EUM

Quicker, gentle positioning

ACE industrial shock absorbers optimize portal for machine loading and increase productivity. This device driven by piston rodless pneumatic cylinders, in which two gripper slides are moving independently of each other at speeds of 2 to 2.5 m/sec., is equipped with industrial shock absorbers as brake systems. Their function is to stop a mass of 25 kg up to 540 times per hour. The model MC3350EUM-1-S was chosen for this application, allowing easy and extremely accurate adjustment of the end positions of the adjustable limit stops. In comparison to brake systems with other function principles, shock absorbers allow higher travel speeds and shorter cycle sequences.

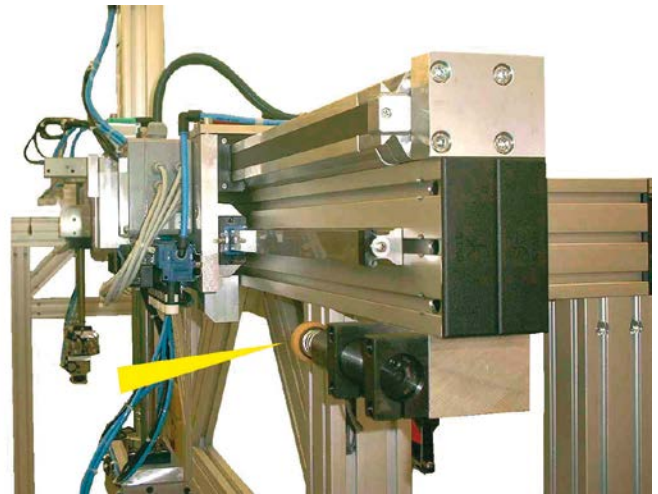
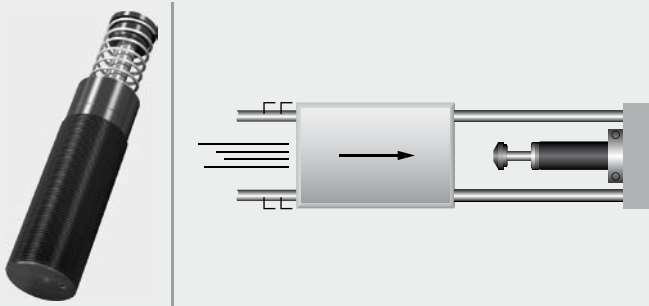

Industrial shock absorbers optimize portal operation

MC45EUM

MAGNUM protection of carriage construction

Serving a similar purpose, several ACE dampers are installed in Jada, the triple-axis, free-moving badminton robot. In order for the badminton robot to be capable of playing, it must be able to change direction in the shortest time possible. Jada is designed therefore to brake at a maximum of 30 m/s². For this task, linear modules are limited by the use of industrial shock absorbers of the type MC4575EUM-0. Miniature shock absorbers and profile dampers are also installed at the location of the "racket hand". In all cases, the modern ACE machine elements serve to protect the end positions of the construction.

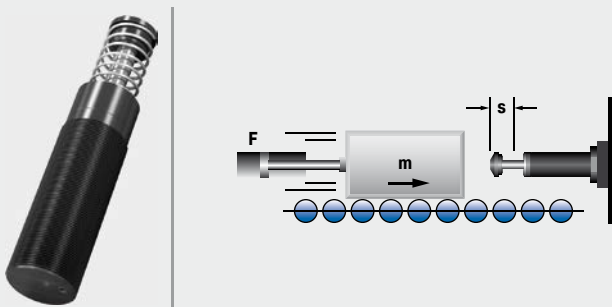

A variety of different dampers are used to slow the rapid movements of a badminton robot
FMTC vzw, 3001 Leuven, Belgium

MC64EUM-VA

MAGNUM damper for safety under water

A pipeline from the rig to the well head that is as flexible as possible is considered to be a quick-disconnect connection in an emergency. Nevertheless, this connection made at the oil source on the sea floor is an Achilles heel. If the connection snaps or if it cannot be separated quickly enough during hazards such as storms, unpredictable, often serious consequences can hardly be prevented. With the so-called XR connector, the safety at this critical point is significantly increased. In the innovative design 10 industrial shock absorbers per connection from the MAGNUM series from ACE master this important task.

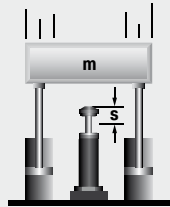

MAGNUMS allow for emergency quick disconnection of the pipelines from the oil rigs
Subsea Technologies Ltd, Aberdeen, AB12 3AY, UK

MA/ML33EUM

Safe swiveling

ACE industrial shock absorbers offer safety to spare for swiveling or braking of large telescope. The optical system of this telescope for special observations is moveable in two space coordinates. The structure in which the telescope is mounted weighs 15,000 kg and consists of a turntable with drives and two wheel disks rotating on bearings. It enables a rotation by $\pm 90^\circ$ from horizon to horizon. To safeguard the telescope in case of overshooting the respective swiveling limits, industrial shock absorbers of the type ML3325EUM are used as braking elements. Should the telescope inadvertently overshoot the permissible swivel range, they will safely damp the travel of the valuable telescope.

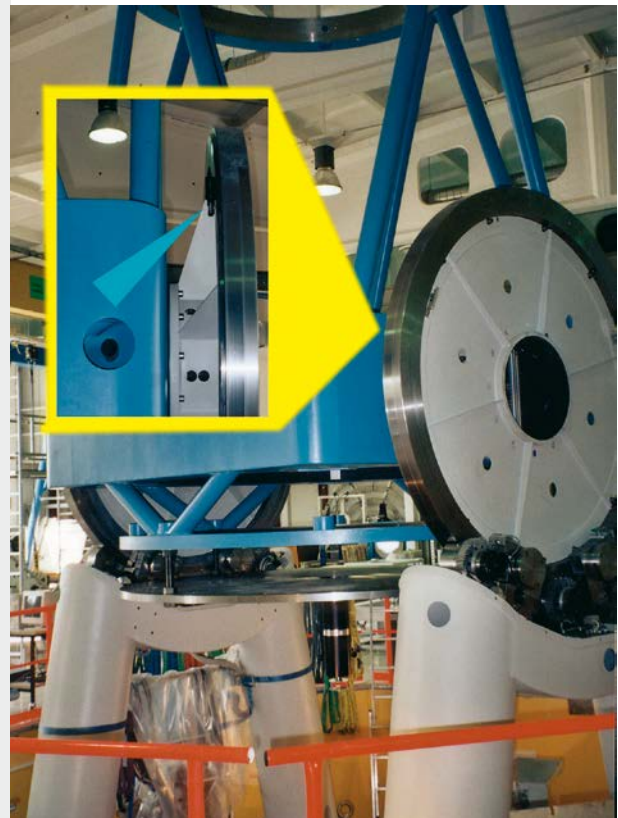
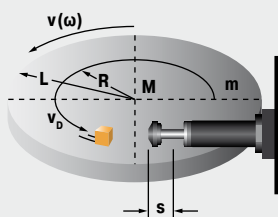

Perfect overshoot protection for precision telescope

Heavy Industrial Shock Absorbers

Effective shock absorption for heavy loads

The heavy industrial shock absorbers from ACE round off the top of the company's offers in damping technology. Designers also have the choice between self-compensating and adjustable machine elements in this category from ACE.

Whichever design is chosen, this type of shock absorber impresses with its robustness and operational readiness wherever heavy loads need reliably stopped on-the-spot at a precise point.

The CA4 models can absorb up to 126,500 Nm of energy. The series of heavy duty, self-compensating CA types are equally suitable for use as an emergency stop as the adjustable types with the designations A1 to A3. The range of effective loads covered is increased considerably for this purpose.



Heavy Industrial Shock Absorbers



CA2 to CA4

Self-Compensating

Deceleration of heavy loads

Portal systems, Machines and plants, Conveyor systems,
Crane systems

Page 82



A1½ to A3

Adjustable

Deceleration of heavy loads and progressive adjustment

Portal systems, Machines and plants, Conveyor systems,
Crane systems

Page 86

Rugged and powerful

Gently stops heavy loads with high precision

Also ideal for emergency stop utilisation

Safe, reliable production

Maintenance-free and ready-to-install

Special versions available



CA2 to CA4

Deceleration of heavy loads

Self-Compensating

Energy capacity 3,600 Nm/Cycle to 126,500 Nm/Cycle

Stroke 50 mm to 406 mm

Powerful: The mass of these high volume absorbers are between 12.8 and 146 kg in weight. They complement ACE's product range of self-compensating shock absorbers. All models from this series are designed for applications where robustness and a large energy absorption are important.

The absorbers are designed specifically for each customer application with the aid of the ACE calculation program. The risk of crashes and incorrect settings are therefore prevented. The CA models can absorb up to 126,500 Nm of energy and can be used in the area of effective loads between 700 kg and 326,000 kg. The combination of being extremely solid, absorbing high levels of energy and having a large damping range makes them invaluable.

These heavy duty self-compensating industrial shock absorbers are primarily used in heavy mechanical engineering e.g. on lift bridges and steel structures or for damping sluice systems.

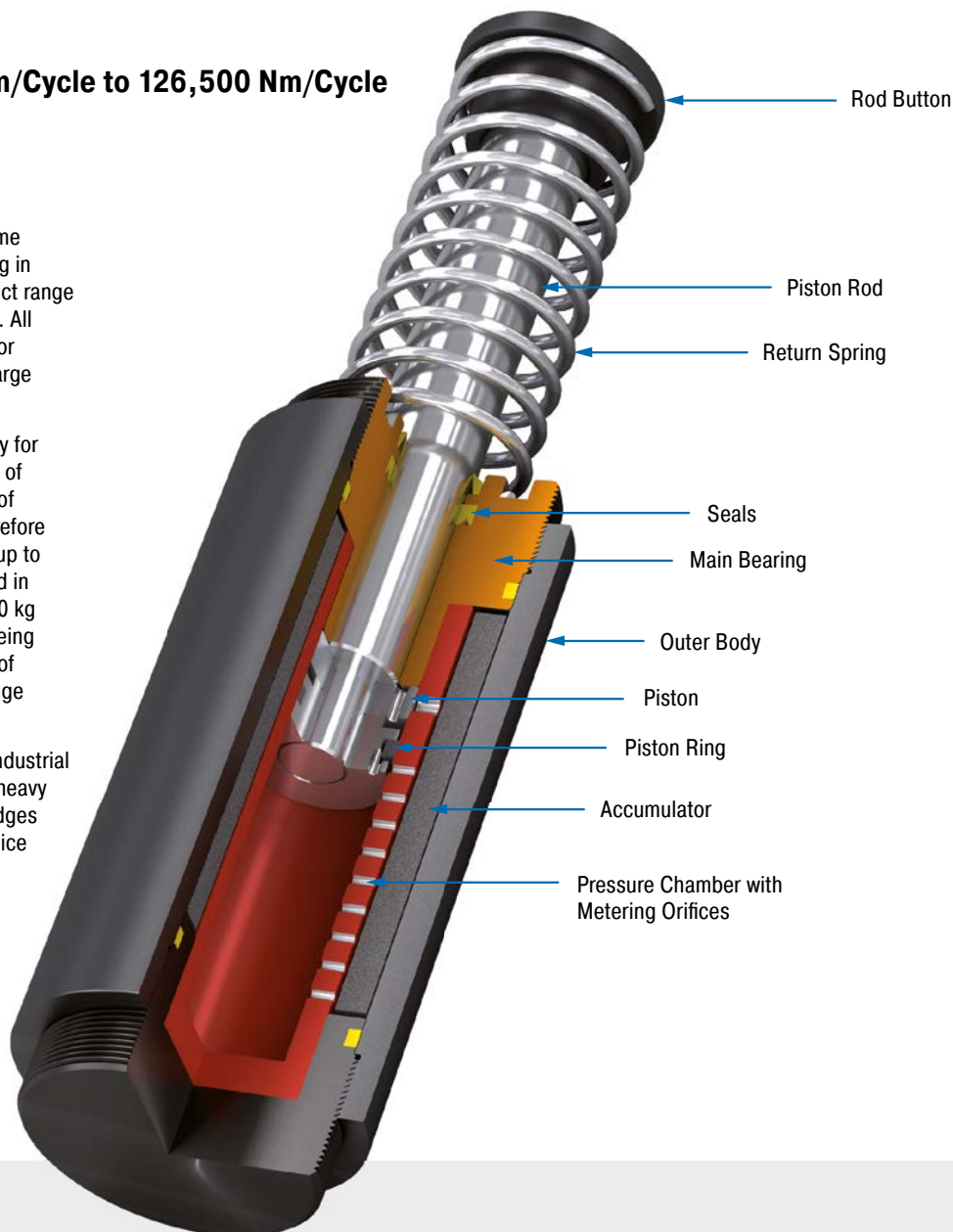

Technical Data

Energy capacity: 3,600 Nm/Cycle to 126,500 Nm/Cycle

Impact velocity range: 0.3 m/s to 5 m/s. Other speeds on request.

Operating temperature range: -12 °C to +66 °C. Other temperatures on request.

Mounting: In any position

Positive stop: External positive stops 2.5 mm to 3 mm before the end of stroke provided by the customer.

Material: Outer body: Steel corrosion-resistant coating; Piston rod: Hard chrome plated steel; Rod end button: Hardened steel and

corrosion-resistant coating; Return spring: Zinc plated steel

Damping medium: Automatic Transmission Fluid (ATF)

Application field: Portal systems, Machines and plants, Conveyor systems, Crane systems, Loading and lifting equipment, Shelf storage systems, Heavy load applications, Swivel units

Note: For emergency use only applications and for continuous use it is possible to exceed the published max. capacity ratings. In this case, please consult ACE.

Safety instructions: External materials in the surrounding area can attack the seal components and lead to a shorter service life. Please

contact ACE for appropriate solution suggestions. Do not paint the shock absorbers due to heat emission.

On request: Special oils, nickel-plated, increased corrosion protection or other special options are available on request.

CA2EU-F Front Flange

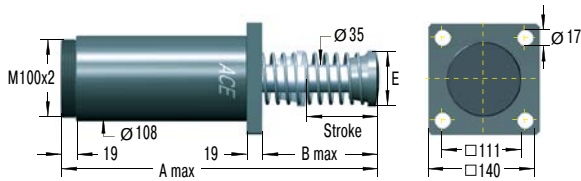

CA2EU-R Rear Flange

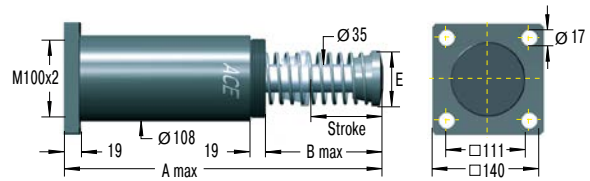

CA2EU-SM Foot Mount

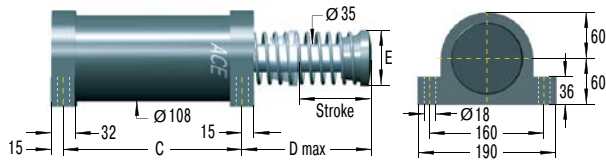

Clevis mounting available on request.

The calculation and selection of the most suitable damper should be carried out or be approved by ACE.

Model Type Prefix

Standard Models

CA: Self-contained with return spring, self-compensating

Special Models

CAA: Air/Oil return without return spring.

Use only with external air/oil tank.

CNA: Self-Contained without return spring

CSA: Air/Oil return with return spring.

Use only with external air/oil tank.

Ordering Example

Self-Compensating CA2x4EU-3F
 Bore Size Ø 2" ↑
 Stroke Length 4" = 102 mm ↑
 EU Compliant ↑
 Effective Weight Range Version ↑
 Front Flange Mounting ↑

Dimensions

BASIC TYPES	Stroke mm	A max. mm	B max. mm	C mm	D max. mm	E mm
CA2X2EU	50	313	110	173	125	70
CA2X4EU	102	414	160	224	175	70
CA2X6EU	152	516	211	275	226	70
CA2X8EU	203	643	287	326	302	92
CA2X10EU	254	745	338	377	353	108

Performance

TYPES	Max. Energy Capacity			Effective Weight			Return Force min. N	Return Force max. N	Return Time s	Side Load Angle max. °	Weight kg
	¹ W ₃ Nm/cycle	² W ₄ Nm/h	² W ₄ with Air/Oil Tank Nm/h	³ me min. kg	³ me max. kg	Hardness					
CA2X2EU-1	3,600	1,100,000	1,350,000	700	2,200	-1	210	285	0.25	3	14.3
CA2X2EU-2	3,600	1,100,000	1,350,000	1,800	5,400	-2	210	285	0.25	3	14.3
CA2X2EU-3	3,600	1,100,000	1,350,000	4,500	13,000	-3	210	285	0.25	3	14.3
CA2X2EU-4	3,600	1,100,000	1,350,000	11,300	34,000	-4	210	285	0.25	3	14.3
CA2X4EU-1	7,200	1,350,000	1,700,000	1,400	4,400	-1	150	285	0.50	3	16.7
CA2X4EU-2	7,200	1,350,000	1,700,000	3,600	11,000	-2	150	285	0.50	3	16.7
CA2X4EU-3	7,200	1,350,000	1,700,000	9,100	27,200	-3	150	285	0.50	3	16.7
CA2X4EU-4	7,200	1,350,000	1,700,000	22,600	68,000	-4	150	285	0.50	3	16.7
CA2X6EU-1	10,800	1,600,000	2,000,000	2,200	6,500	-1	150	400	0.60	3	19.3
CA2X6EU-2	10,800	1,600,000	2,000,000	5,400	16,300	-2	150	400	0.60	3	19.3
CA2X6EU-3	10,800	1,600,000	2,000,000	13,600	40,800	-3	150	400	0.60	3	19.3
CA2X6EU-4	10,800	1,600,000	2,000,000	34,000	102,000	-4	150	400	0.60	3	19.3
CA2X8EU-1	14,500	1,900,000	2,400,000	2,900	8,700	-1	230	650	0.70	3	22.3
CA2X8EU-2	14,500	1,900,000	2,400,000	7,200	21,700	-2	230	650	0.70	3	22.3
CA2X8EU-3	14,500	1,900,000	2,400,000	18,100	54,400	-3	230	650	0.70	3	22.3
CA2X8EU-4	14,500	1,900,000	2,400,000	45,300	136,000	-4	230	650	0.70	3	22.3
CA2X10EU-1	18,000	2,200,000	2,700,000	3,600	11,000	-1	160	460	0.80	3	32.3
CA2X10EU-2	18,000	2,200,000	2,700,000	9,100	27,200	-2	160	460	0.80	3	32.3
CA2X10EU-3	18,000	2,200,000	2,700,000	22,600	68,000	-3	160	460	0.80	3	32.3
CA2X10EU-4	18,000	2,200,000	2,700,000	56,600	170,000	-4	160	460	0.80	3	32.3

¹ For emergency use only applications it is sometimes possible to exceed the above ratings. Please consult ACE for further details.

² Figures for oil recirculation systems on request.

³ The effective weight range limits can be raised or lowered to special order.

Self-Compensating

CA3EU-F Front Flange

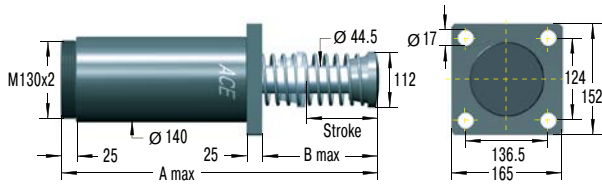

CA3EU-R Rear Flange

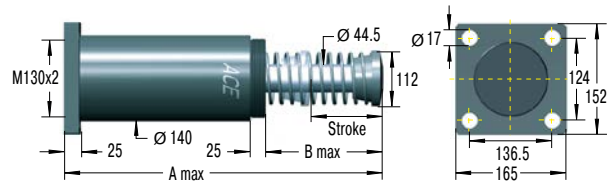

CA3EU-S Foot Mount

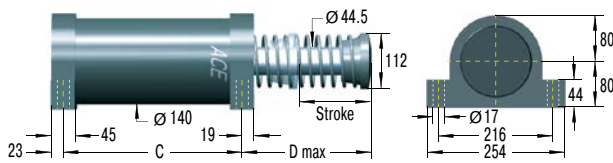

Clevis mounting available on request.

The calculation and selection of the most suitable damper should be carried out or be approved by ACE.

Model Type Prefix

Standard Models

CA: Self-contained with return spring, self-compensating

Special Models

CAA: Air/Oil return without return spring.

Use only with external air/oil tank.

CNA: Self-Contained without return spring

CSA: Air/Oil return with return spring.

Use only with external air/oil tank.

Ordering Example

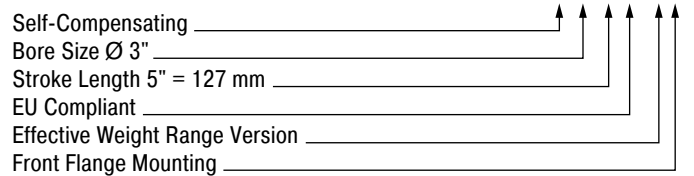

Dimensions

BASIC TYPES	Stroke mm	A max. mm	B max. mm	C mm	D max. mm
CA3X5EU	127	490.5	211	254	224
CA3X8EU	203	641	286	330	300
CA3X12EU	305	890	434	432	447

Performance

TYPES	Max. Energy Capacity			Effective Weight			Return Force min. N	Return Force max. N	Return Time s	Side Load Angle max. °	Weight kg
	¹ W ₃ Nm/cycle	² W ₄ Nm/h	² W ₄ with Air/Oil Tank Nm/h	³ me min. kg	³ me max. kg	Hardness					
CA3X5EU-1	14,125	2,260,000	2,800,000	2,900	8,700	-1	270	710	0.6	3	32.7
CA3X5EU-2	14,125	2,260,000	2,800,000	7,250	21,700	-2	270	710	0.6	3	32.7
CA3X5EU-3	14,125	2,260,000	2,800,000	18,100	54,350	-3	270	710	0.6	3	32.7
CA3X5EU-4	14,125	2,260,000	2,800,000	45,300	135,900	-4	270	710	0.6	3	32.7
CA3X8EU-1	22,600	3,600,000	4,520,000	4,650	13,900	-1	280	740	0.8	3	38.5
CA3X8EU-2	22,600	3,600,000	4,520,000	11,600	34,800	-2	280	740	0.8	3	38.5
CA3X8EU-3	22,600	3,600,000	4,520,000	29,000	87,000	-3	280	740	0.8	3	38.5
CA3X8EU-4	22,600	3,600,000	4,520,000	72,500	217,000	-4	280	740	0.8	3	38.5
CA3X12EU-1	33,900	5,400,000	6,780,000	6,950	20,900	-1	270	730	1.2	3	47.6
CA3X12EU-2	33,900	5,400,000	6,780,000	17,400	52,200	-2	270	730	1.2	3	47.6
CA3X12EU-3	33,900	5,400,000	6,780,000	43,500	130,450	-3	270	730	1.2	3	47.6
CA3X12EU-4	33,900	5,400,000	6,780,000	108,700	326,000	-4	270	730	1.2	3	47.6

¹ For emergency use only applications it is sometimes possible to exceed the above ratings. Please consult ACE for further details.

² Figures for oil recirculation systems on request.

³ The effective weight range limits can be raised or lowered to special order.

CA4EU-F Front Flange

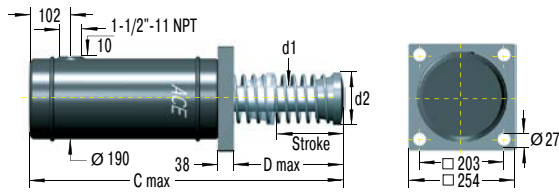

CA4EU-R Rear Flange

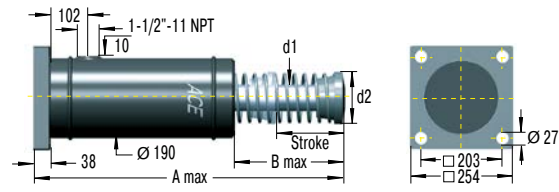

CA4EU-FRP 6 Tapped Holes

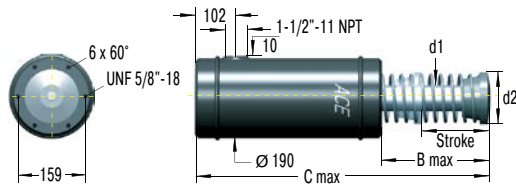

Clevis mounting available on request.

CA4EU-S Foot Mount

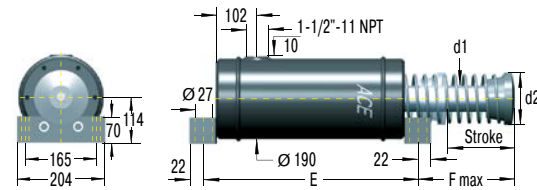

Clevis mounting available on request.

The calculation and selection of the most suitable damper should be carried out or be approved by ACE.

Model Type Prefix

Standard Models

CA: Self-contained with return spring, self-compensating

Special Models

CAA: Air/Oil return without return spring.

Use only with external air/oil tank.

CNA: Self-Contained without return spring

CSA: Air/Oil return with return spring.

Use only with external air/oil tank.

Ordering Example

Self-Compensating **CA4x8EU-5R**
 Bore Size Ø 4"
 Stroke Length 8" = 203 mm
 EU Compliant
 Effective Weight Range Version
 Rear Flange Mounting

Dimensions

	Stroke	A max.	B max.	C max.	D max.	d1	d2	E	F
BASIC TYPES	mm	mm	mm	mm	mm	mm	mm	mm	mm
CA4X6EU	152	716	278	678	240	54	114	444	256
CA4X8EU	203	818	329	780	291	54	114	495	307
CA4X16EU	406	1,300	608.5	1,262.6	569	63.5	127	698	585

Performance

TYPES	Max. Energy Capacity				Effective Weight			Return Force min. N	Return Force max. N	Return Time s	Weight kg
	¹ W ₃ Nm/cycle	W ₄ Nm/h	W ₄ with Air/Oil Tank Nm/h	W ₄ with Oil Recirculation Nm/h	² me min. kg	² me max. kg	Hardness				
CA4X6EU-3	47,500	3,000,000	5,100,000	6,600,000	3,500	8,600	-3	480	1,000	1.8	60
CA4X6EU-5	47,500	3,000,000	5,100,000	6,600,000	8,600	18,600	-5	480	1,000	1.8	60
CA4X6EU-7	47,500	3,000,000	5,100,000	6,600,000	18,600	42,700	-7	480	1,000	1.8	60
CA4X8EU-3	63,300	3,400,000	5,600,000	7,300,000	5,000	11,400	-3	310	1,000	2.3	68
CA4X8EU-5	63,300	3,400,000	5,600,000	7,300,000	11,400	25,000	-5	310	1,000	2.3	68
CA4X8EU-7	63,300	3,400,000	5,600,000	7,300,000	25,000	57,000	-7	310	1,000	2.3	68
CA4X16EU-3	126,500	5,600,000	9,600,000	12,400,000	10,000	23,000	-3	310	1,000	ask	146
CA4X16EU-5	126,500	5,600,000	9,600,000	12,400,000	23,000	50,000	-5	310	1,000	ask	146
CA4X16EU-7	126,500	5,600,000	9,600,000	12,400,000	50,000	115,000	-7	310	1,000	ask	146

¹ For emergency use only applications it is sometimes possible to exceed the above ratings. Please consult ACE for further details.

² The effective weight range limits can be raised or lowered to special order.

A1½ to A3

Deceleration of heavy loads and progressive adjustment

Adjustable

Energy capacity 2,350 Nm/Cycle to 44,000 Nm/Cycle
Stroke 50 mm to 305 mm

Strong and adjustable: Also in ACE's range of units are heavy duty industrial shock absorbers, which can be adjusted. The models from the A1½ to A3 range, which weigh between 7.55 kg and 48 kg, are extremely robust, ready-to-install hydraulic machine elements with impressively high energy absorption levels and a wide range of damping rates.

Their special aspect is the flexibility, as all the absorbers can be adjusted using a socket on the absorber base and be perfectly adapted to the required data. The A models cover a range of effective loads from 0.3 kg to 204,000 kg and can absorb up to 44,000 Nm energy.

These heavy duty, adjustable ACE industrial shock absorbers are the first choice in heavy duty applications and generally in heavy mechanical engineering when the usage data has not been exactly determined.

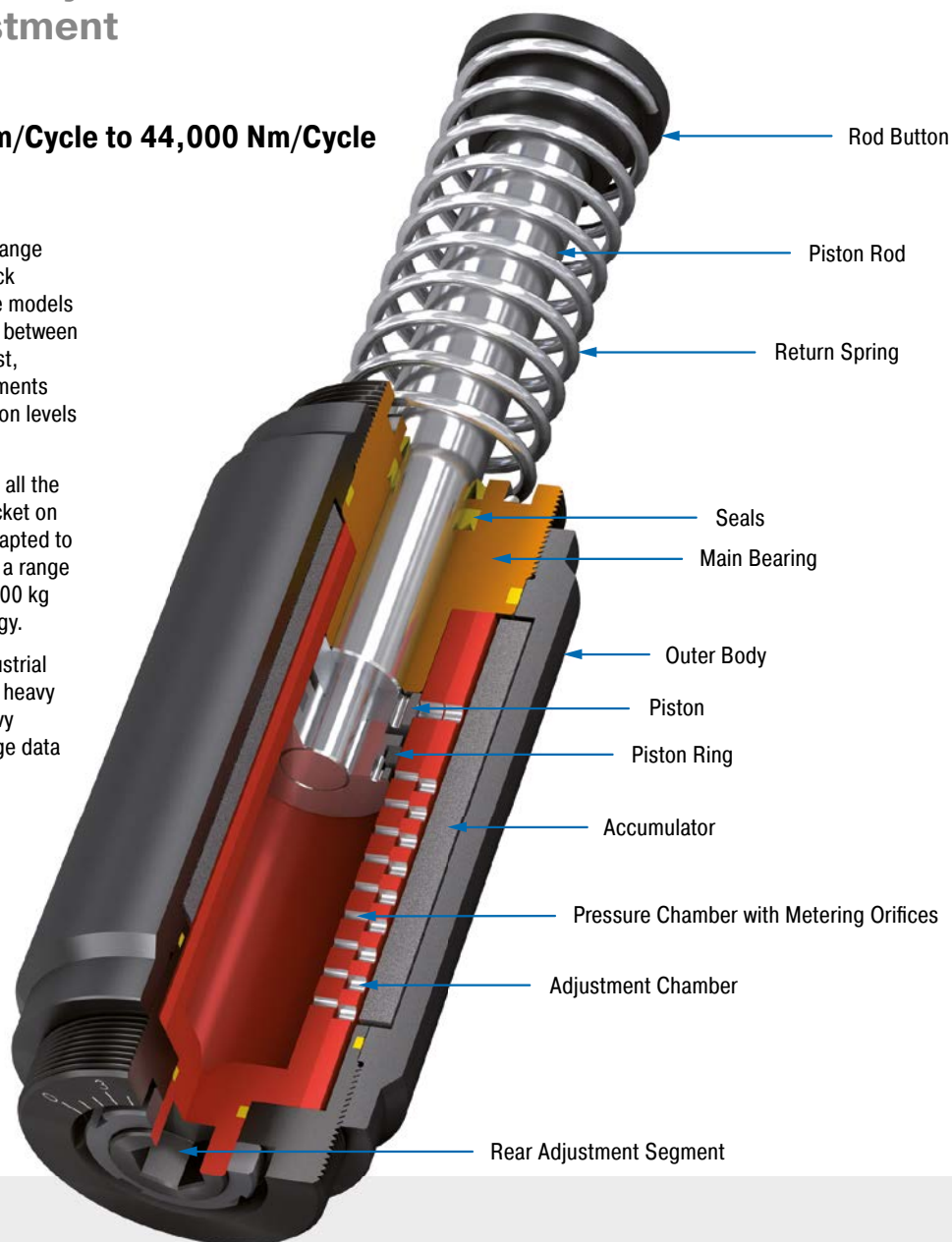

Technical Data

Energy capacity: 2,350 Nm/Cycle to 44,000 Nm/Cycle

Impact velocity range: 0.1 m/s to 5 m/s. Other speeds on request.

Operating temperature range: -12 °C to +66 °C. Other temperatures on request.

Mounting: In any position

Positive stop: External positive stops 2.5 mm to 3 mm before the end of stroke provided by the customer.

Adjustment: Hard impact at the start of stroke, adjust the ring towards 9. Hard impact at the end of stroke, adjust the ring towards 0.

Material: Outer body: Steel corrosion-resistant coating; Piston rod: Hard chrome plated steel; Rod end button: Hardened steel and corrosion-resistant coating; Return spring: Zinc plated steel

Damping medium: Automatic Transmission Fluid (ATF)

Application field: Portal systems, Machines and plants, Conveyor systems, Crane systems, Loading and lifting equipment, Impact panels, Heavy load applications, Swivel units, Shelf storage systems

Note: For emergency use only applications and for continuous use it is possible to exceed

the published max. capacity ratings. In this case, please consult ACE.

Safety instructions: External materials in the surrounding area can attack the seal components and lead to a shorter service life. Please contact ACE for appropriate solution suggestions. Do not paint the shock absorbers due to heat emission.

On request: Special oils, nickel-plated, increased corrosion protection or other special options are available on request.

A1½EU-F Front Flange

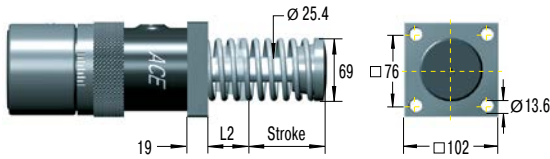

A1½EU-R Rear Flange

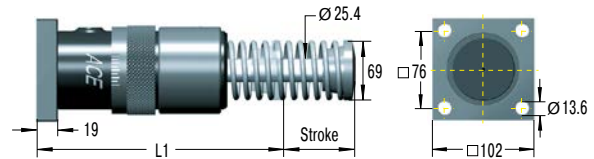

A1½EU-C Clevis Mount

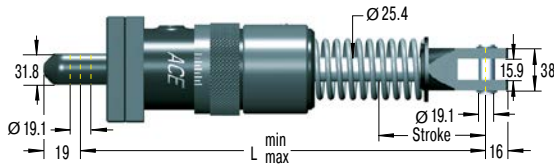

A1½EU-S Foot Mount

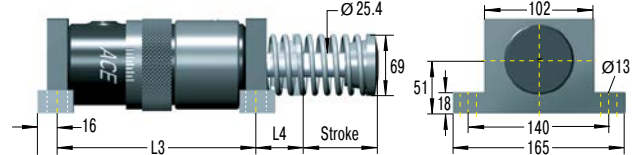

The calculation and selection of the most suitable damper should be carried out or be approved by ACE.

Model Type Prefix

Standard Models

A: Self-contained with return spring, adjustable

Special Models

AA: Air/Oil return without return spring.

Use only with external air/oil tank.

NA: Self-contained without return spring

SA: Air/Oil return with return spring.

Use only with external air/oil tank.

Ordering Example

Adjustable _____ **A1½x2EUR**
 Bore Size Ø 1½" _____
 Stroke Length 2" = 50.8 mm _____
 EU Compliant _____
 Rear Flange Mounting _____

Dimensions

TYPES	Stroke mm	L min. mm	L max. mm	L1 mm	L2 mm	L3 mm	L4 mm
A1½X2EU	50	277.8	328.6	195.2	54.2	-	-
A1½X3½EU	89	316.6	405.6	233	54.2	170	58.6
A1½X5EU	127	354.8	481.8	271.5	54.2	208	58.6
A1½X6½EU	165	412	577	329	73	246	78

Performance

TYPES	Max. Energy Capacity			Effective Weight		Return Force min. N	Return Force max. N	Return Time s	Side Load Angle max. °	Weight kg
	¹ W ₃ Nm/cycle	² W ₄ Nm/h	² W ₄ with Air/Oil Tank Nm/h	³ me min. kg	³ me max. kg					
A1½X2EU	2,350	362,000	452,000	195	32,000	160	210	0.10	5	7.6
A1½X3½EU	4,150	633,000	791,000	218	36,000	110	210	0.25	4	8.9
A1½X5EU	5,900	904,000	1,130,000	227	41,000	90	230	0.40	3	9.4
A1½X6½EU	7,700	1,180,000	1,469,000	308	45,000	90	430	0.40	2	12.0

¹ For emergency use only applications it is sometimes possible to exceed the above ratings. Please consult ACE for further details.

² Figures for oil recirculation systems on request.

³ The effective weight range limits can be raised or lowered to special order.

Adjustable

A2EU-F Front Flange

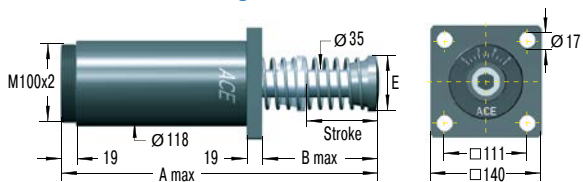

A2EU-R Rear Flange

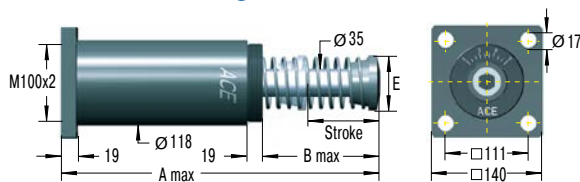

A2EU-SM Foot Mount

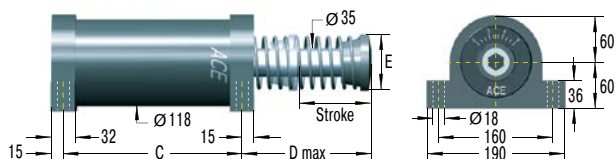

The calculation and selection of the most suitable damper should be carried out or be approved by ACE.

Model Type Prefix

Standard Models

A: Self-contained with return spring, adjustable

Special Models

AA: Air/Oil return without return spring.

Use only with external air/oil tank.

NA: Self-contained without return spring

SA: Air/Oil return with return spring.

Use only with external air/oil tank.

Ordering Example

Adjustable _____ **A2x6EU-R**
 Bore Size Ø 2" _____
 Stroke Length 6" = 152 mm _____
 EU Compliant _____
 Rear Flange Mounting _____

Dimensions

TYPES	Stroke mm	A max. mm	B max. mm	C mm	D max. mm	E mm
A2X2EU	50	313	110	173	125	70
A2X4EU	102	414	160	224	175	70
A2X6EU	152	516	211	275	226	70
A2X8EU	203	643	287	326	302	92
A2X10EU	254	745	338	377	353	108

Performance

TYPES	Max. Energy Capacity			Effective Weight		Return Force min. N	Return Force max. N	Return Time s	Side Load Angle max. °	Weight kg
	¹ W ₃ Nm/cycle	² W ₄ Nm/h	² W ₄ with Air/Oil Tank Nm/h	³ me min. kg	³ me max. kg					
A2X2EU	3,600	1,100,000	1,350,000	250	77,000	210	285	0.25	3	14.3
A2X4EU	9,000	1,350,000	1,700,000	250	82,000	150	285	0.50	3	16.7
A2X6EU	13,500	1,600,000	2,000,000	260	86,000	150	400	0.60	3	19.3
A2X8EU	19,200	1,900,000	2,400,000	260	90,000	230	650	0.70	3	22.3
A2X10EU	23,700	2,200,000	2,700,000	320	113,000	160	460	0.80	3	26.2

¹ For emergency use only applications it is sometimes possible to exceed the above ratings. Please consult ACE for further details.

² Figures for oil recirculation systems on request.

³ The effective weight range limits can be raised or lowered to special order.

A3EU-F Front Flange

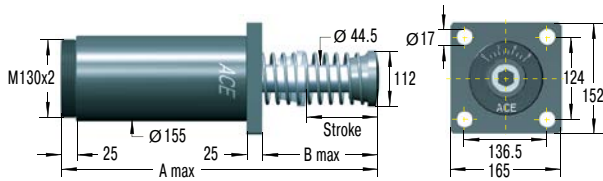

A3EU-R Rear Flange

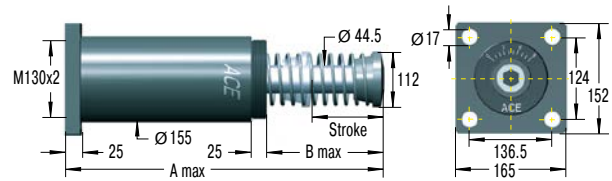

A3EU-S Foot Mount

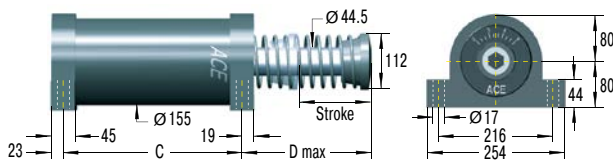

The calculation and selection of the most suitable damper should be carried out or be approved by ACE.

Model Type Prefix

Standard Models

A: Self-contained with return spring, adjustable

Special Models

AA: Air/Oil return without return spring.

Use only with external air/oil tank.

NA: Self-contained without return spring

SA: Air/Oil return with return spring.

Use only with external air/oil tank.

Ordering Example

Adjustable _____ **A3x8EUR**
 Bore Size Ø 3" _____
 Stroke Length 8" = 203 mm _____
 EU Compliant _____
 Rear Flange Mounting _____

Dimensions

TYPES	Stroke mm	A max. mm	B max. mm	C mm	D max. mm
A3X5EU	127	490.5	211	254	224
A3X8EU	203	641	286	330	300
A3X12EU	305	890	434	432	447

Performance

TYPES	Max. Energy Capacity			Effective Weight		Return Force min. N	Return Force max. N	Return Time s	Side Load Angle max. °	Weight kg
	¹ W ₃ Nm/cycle	² W ₄ Nm/h	² W ₄ with Air/Oil Tank Nm/h	³ me min. kg	³ me max. kg					
A3X5EU	15,800	2,260,000	2,800,000	480	154,000	270	710	0.6	3	32.7
A3X8EU	28,200	3,600,000	4,520,000	540	181,500	280	740	0.8	3	38.5
A3X12EU	44,000	5,400,000	6,780,000	610	204,000	270	730	1.2	3	48.0

¹ For emergency use only applications it is sometimes possible to exceed the above ratings. Please consult ACE for further details.

² Figures for oil recirculation systems on request.

³ The effective weight range limits can be raised or lowered to special order.

Air/Oil Tanks for industrial shock absorbers

**For high cycle rates and extreme temperatures
with limited mounting space**

Shock absorbers convert the introduced energy into heat. The more frequently a shock absorber is stressed per hour, the hotter the oil volume becomes over time. If the requirements placed on the impact frequency of a shock absorber are especially high the use of an air-oil tank is just the right thing.

Thanks to the increased oil volume and the resulting heat dissipation, the upper limit of the possible hourly energy capacity of the shock absorber increases significantly.

Another characteristic of the air-oil tank is the opportunity for controlled piston return if no permanent return force through an integrated spring in the shock absorber is desired.

Air/Oil Tanks AO

A01

Oil capacity 20 cm³

Material: Aluminium caps

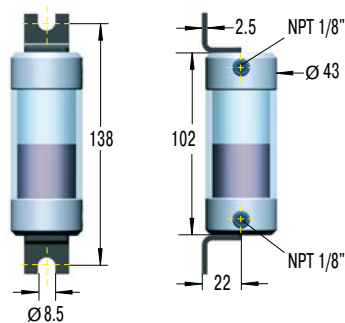

Detail drawings on request

A03

Oil capacity 370 cm³

Material: Steel



A06

Oil capacity 2,600 cm³

Material: Steel

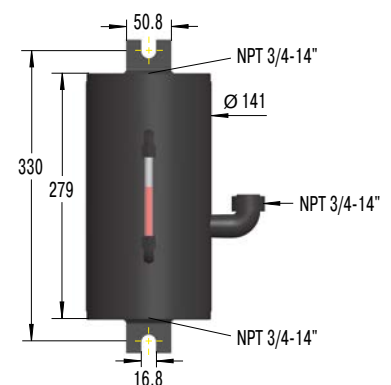

Technical Data

Operating pressure: Max. 8 bar

Operating temperature range: 80 °C

Damping medium: ATF-Oil 42 cSt at 40 °C
Mount air/oil tank higher than shock absorber.
Bleed all air from system before operating.

Safety instructions: Exhaust tank before carrying out service. Check valve holds pressure!

Suggested air/oil tanks in accordance with W₄ ratings

Connection Examples

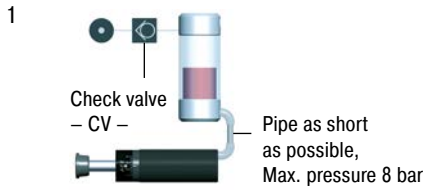

Piston rod returns immediately to extended position when load moves away. Operation without main air supply possible for short periods.

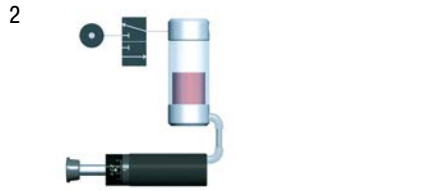

Return stroke may be sequenced by pneumatic valve at any desired time. No return force until valve energised.

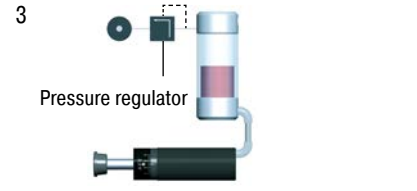

Return force can be adjusted by pressure regulator. Ensure safe minimum pressure to return shock absorber.



Spring return with air/oil tank. No air supply connected. Note: Will extend return time.

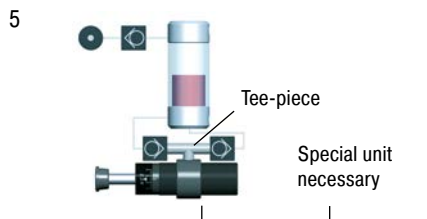

Oil recirculation circuit for extreme high cycle rates. Warm oil is positively circulated through air/oil tank for increased heat dissipation.

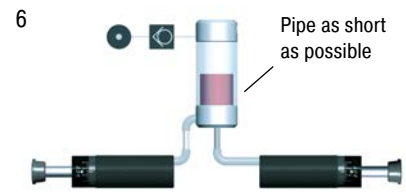

Connection of two shock absorbers to one air/oil tank is possible. Use next larger size tank. Combination with examples 2, 3 and 5 possible.

Selection Chart Air/Oil Tanks

Shock Absorber Type	With Tank Example 1 to 4		With Recirc. Circuits Example 5 to 6		Min. Conn. Pipe Ø mm	Thread Sizes for Connection to Air/Oil Tank	
	Tank	Check Valve	Tank	Check Valve		Thread Bottom	² Thread Side
MCA, MAA, MLA33...	A01	CV1/8	A03	CV1/4	4	¹ 1/8-27 NPTF inside	1/8-27 NPTF inside
MCA, MAA, MLA45...	A01	CV1/8	A03	CV3/8	6	1/8-27 NPTF inside	1/8-27 NPTF inside
MCA, MAA, MLA64...	A03	CV1/4	A06	CV3/4	8	1/4-18 NPTF inside	1/4-18 NPTF inside
CAA, AA2...	A06	CV3/4	A082	CV3/4	15	-	-
CAA, AA3...	A06	CV3/4	A082	CV3/4	19	-	-
CAA4...	A082	CV3/4	A082	CV3/4	38	-	-

A082 and connection accessories: Details on request

¹ adapted

² on request (add suffix -PG/-P)

Check Valves CV

Through an oil circuit fresh oil is drawn in from the industrial shock absorber and warm oil is pumped off (see example 5). To obtain this function, ACE offers suitable check valves of the CV series.

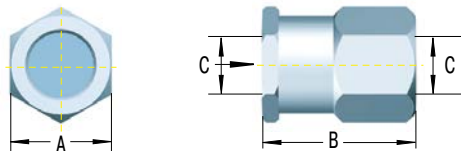

Technical Data

Operating pressure: 20 bar

Operating temperature range: 95 °C

Suitable for: Oil, air, water

Material: Aluminium

Check Valves – Dimensions

TYPES	A mm	B mm	C
CV1/8	19	24	1/8-27 NPT
CV1/4	29	33	1/4-18 NPT
CV3/8	29	33	3/8-18 NPT
CV1/2	41	40	1/2-14 NPT
CV3/4	48	59	3/4-14 NPT

Pallet Stoppers

Control the flow of mass goods

ACE offers a wide range of products for the most varied requirements in transfer technology – known as pallet stoppers or separators. These allow work-piece carriers with masses from 0.25 kg up to 1,200 kg to be separated from one another and forwarded individually. Further products such as positioning units or non-return devices and an extensive range of accessories are available on request.



Pallet stoppers are used between individual processing stations within transport systems. Most objects transported on small pallets are halted at the processing stations or separated from a convoy.

Our compact machine elements operate pneumatically or electrically, with damping provided pneumatically or via integrated ACE shock absorbers. The pneumatic versions offer a choice between single-acting and double-acting separators that function either with or without inductive or electronic monitoring. The electric versions all provide shock-free operation in environments without compressed air.



Transfer Technology Components

Greatest process reliability and cycle stability

ACE pallet stoppers ensure gentle, precise and accurate damping of pallets and workpiece carriers on belt and roller conveyor systems and accumulating roller conveyors. This leaves transported goods and machinery unharmed and optimises process engineering. The high product quality increases speed along with improved longevity and reliability.

Our complete range of pallet stoppers combined with comprehensive accessories guarantees the greatest possible flexibility and maximum compatibility with a multitude of standard transfer systems.

High product quality

Cost-effective, sturdy solutions

Wide selection, even independent of compressed air

Suitable for high speeds

Space-saving and easy to install

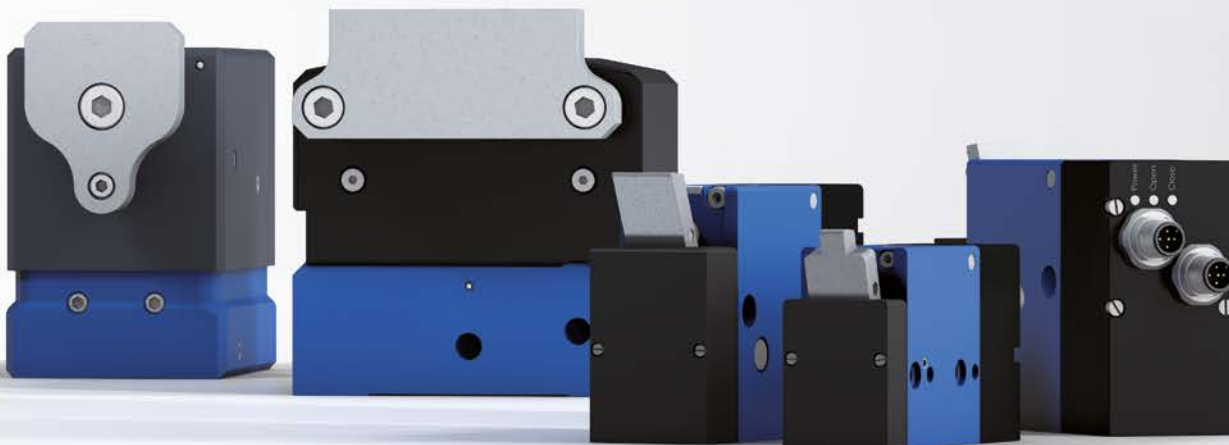

More information about pallet stoppers can be found on our Website www.ace-ace.com

Pneumatic Pallet Stoppers

Gentle deceleration of light to heavy loads

The pneumatic ACE separators are divided into seven product families that cover mass ranges from 1 kg to 1,200 kg. A distinction is made in the case of attenuated products between monitoring options and between single-acting and double-acting models.

Speed and precise working are the top priority in production. ACE pallet stoppers are the ideal aids whenever workpieces have to be manoeuvred quickly and gently through production. This is because they provide shock-free deceleration of workpiece carriers, bring them to a pinpoint standstill and use pneumatic lowering to release them again to the next processing station after a freely definable waiting time – jointly or individually. Pneumatic damping force can be continuously adapted to the weight of the workpiece carrier.



P-P60

Our smallest: stops masses between 1 kg and 60 kg

These are the smallest of the pneumatically-operated damping modules offered by ACE and they reliably stop masses from 1 kg up to 60 kg. They are used whilst manoeuvring sensitive products on transfer systems.

**Strong, precise,
self-compensating or
adjustable**

P-H1200

The largest: gentle and precise with an ACE shock absorber.

For heavy workpiece carriers up to 1.2 tons!

Pure performance. Our largest pneumatic pallet stopper with integrated ACE shock absorber decelerates even high masses of 40 kg to 1,200 kg extremely effectively. Ideal for transferring sensitive products with significant weight.

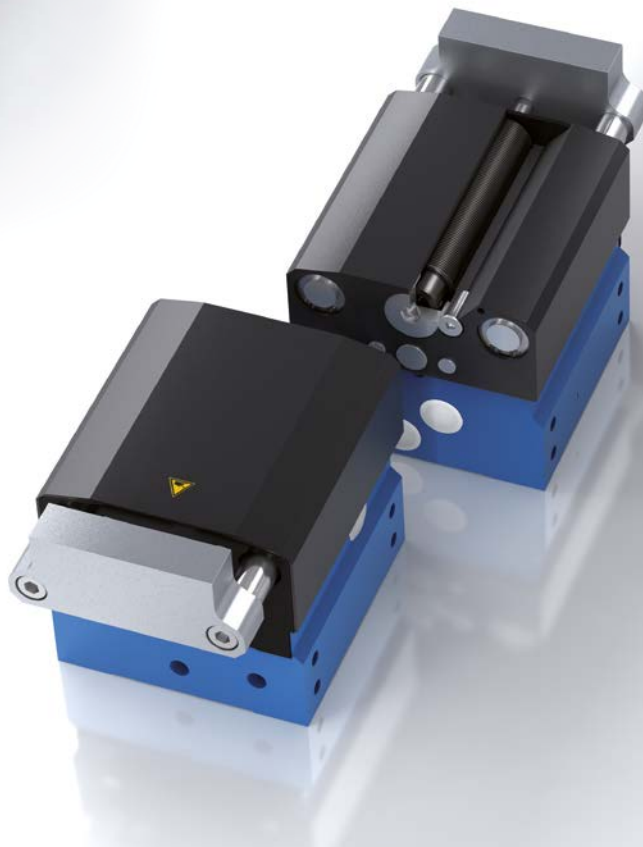

Electric Pallet Stoppers

Perfect for safe and quiet operation

ACE electrically controlled separators come in four product families and cover a mass range from 0.25 kg up to 600 kg. The fact that these separators can manage without compressed air results in numerous benefits.

The positive aspects include less noise, greater environmental protection and higher efficiency. Electric models also work intelligently due to their sophisticated technology because they are self-compensating within larger weight ranges. The individual models are available with a 2x5-pin M12x1 connector, which can be attached to separators and cabled to a PLC. All in all, this provides a very convenient solution thanks to a reduced requirement for maintenance.

Quiet, without compressed air, simple installation



P-E600

Impressive: with an integrated ACE shock absorber for maximum accumulated loads up to 600 kg

These electrically-operated ACE modules reliably stop even large masses, among other things using the built-in ACE shock absorber. A guarantee for quiet and safe operation.



P-E20

Small and delicate – for accumulated loads from 0.25 kg up to 20 kg

These are the smallest, electrically-operated damping modules offered by ACE and are optimised for stopping lighter masses. They are used for the transfer of sensitive products at high speeds.

Profile Dampers

The low cost alternative for continuous duty

The exceedingly successful TUBUS series from ACE is a perfect alternative, when masses don't need to be decelerated to an exact point. Available in more than 140 different versions, the profile dampers are used to slow down masses, particularly under extreme conditions.

They are also recommended for use if there is little installation space available. Manufactured in co-polyester elastomer, the highly resistant absorbers provide the best benefits in areas where other materials fail or where a similarly high service life of up to 1 million load changes cannot be achieved. They are affordable, compact and light and absorb the energy with different damping characteristics depending on the design.

Very good price/performance ratio

Reliable in extreme situations

Highly resistant material

Compact and lightweight design

Easy to mount

Long service life



Physical Properties of TUBUS Profile Dampers

ACE TUBUS profile dampers are high performance damping elements made from a special Co-Polyester Elastomer. They have a high energy absorbing capacity compared with other materials.

The excellent damping characteristics are achieved as a result of the special elastomer material and the worldwide unique construction design. This enables us to change the characteristics of the elastomer material so that individual and distinct damping curves are possible.

TUBUS dampers offer a considerable performance advantage when compared to other materials such as rubber, urethanes (PUR) and steel springs.

A further advantage compared to other damping elements is the operating life expectancy – up to twenty times longer than with urethane dampers, up to ten times longer than with rubber dampers and up to five times longer than with steel spring dampers.

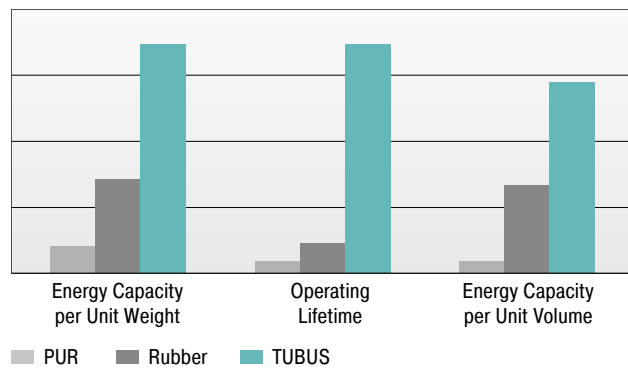

Comparison of Damping Characteristics

The innovative TUBUS dampers absorb energy while exhibiting the following damping characteristics:

Product family TA

Degressive characteristic with max. energy absorption with min. stroke.

Energy absorption: 58 % to 73 %

Product family TS

Almost linear characteristic with low reaction force over a short operating stroke.

Energy absorption: 35 % to 64 %

Product family TR/TR-L/TR-H

Progressive characteristic with gradually increasing reaction force over a long stroke.

Energy absorption TR: 25 % to 45 %

Energy absorption TR-L: 26 % to 41 %

Energy absorption TR-H: 39 % to 62 %

Product family TR-HD

Progressive characteristic with high energy absorption with a short stroke.

Energy absorption: 43 % to 72 %

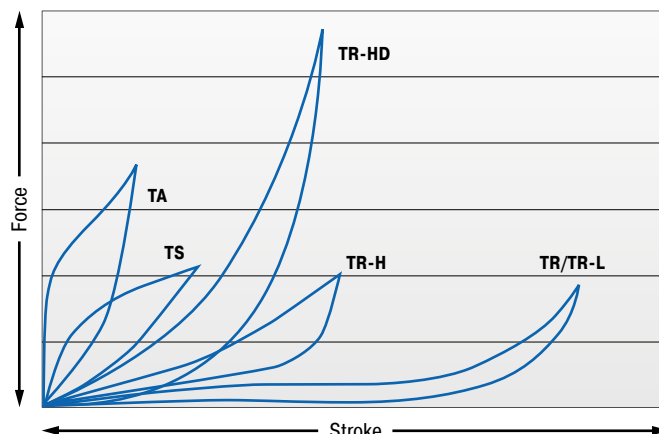

Characteristics of dynamic energy absorption for impact velocity over 0.5 m/s.

or impact velocities under 0.5 m/s, please request a static characteristic curve.

TUBUS TA, TS, TR, TR-H, TR-HD

TYPES	Max. Energy Capacity		Stroke max. mm	Page
	¹ W ₃ Nm/cycle	Emergency Stop W ₃ Nm/cycle		
TA12-5	2.0	3	5	101
TA17-7	6.0	9	7	101
TA21-9	10.0	16	9	101
TA22-10	11.5	21	10	101
TA28-12	29.0	46	12	101
TA34-14	48.0	87	14	101
TA37-16	65.0	112	16	101
TA40-16	82.0	130	16	101
TA43-18	112.0	165	18	101
TA47-20	140.0	173	20	101
TA50-22	170.0	223	22	101
TA54-22	201.0	334	22	101
TA57-24	242.0	302	24	101
TA62-25	304.0	361	25	101
TA65-27	374.0	468	27	101
TA70-29	421.0	524	29	101
TA72-31	482.0	559	31	101
TA80-32	570.0	831	32	101
TA82-35	683.0	921	35	101
TA85-36	797.0	1,043	36	101
TA90-38	934.0	1,249	38	101
TA98-40	1,147.0	1,555	40	101
TA116-48	2,014.0	2,951	48	101
TS14-7	2.0	3	7	103
TS18-9	4.0	6	9	103
TS20-10	6.0	7	10	103
TS26-15	11.5	15	15	103
TS32-16	23.0	26	16	103
TS35-19	30.0	36	19	103
TS40-19	34.0	42	19	103
TS41-21	48.0	63	21	103
TS44-23	63.0	72	23	103
TS48-25	81.0	91	25	103
TS51-27	92.0	114	27	103
TS54-29	122.0	158	29	103
TS58-30	149.0	154	30	103
TS61-32	163.0	169	32	103
TS64-34	208.0	254	34	103
TS68-36	227.0	272	36	103
TS75-39	291.0	408	39	103
TS78-40	352.0	459	40	103
TS82-44	419.0	620	44	103
TS84-43	475.0	635	43	103
TS90-47	580.0	778	47	103
TS107-56	902.0	966	56	103
TR29-17	1.2	1.8	17	105
TR37-22	2.3	5.4	22	105
TR43-25	3.5	8.1	25	105
TR50-35	5.8	8.3	35	105
TR63-43	12.0	17.0	43	105
TR67-40	23.0	33.0	40	105
TR76-46	34.5	43.0	46	105
TR83-50	45.0	74.0	50	105
TR85-50	68.0	92.0	50	105
TR93-57	92.0	122.0	57	105
TR100-60	115.0	146.0	60	105
TR30-15H	2.7	5.7	15	107
TR39-19H	6.0	18.0	19	107
TR45-23H	8.7	24.0	23	107
TR52-32H	11.7	20.0	32	107
TR64-41H	25.0	46.0	41	107
TR68-37H	66.5	98.0	37	107
TR79-42H	81.5	106.0	42	107
TR86-45H	124.0	206.0	45	107
TR87-46H	158.0	261.0	46	107
TR95-50H	228.0	342.0	50	107
TR102-56H	290.0	427.0	56	107
TR42-14HD	405	567	14	111
TR47-12HD	857	1,200	12	111
TR47-17HD	850	1,190	17	111
TR52-14HD	1,634	2,288	14	111
TR57-21HD	1,194	1,672	21	111

TUBUS TA, TS, TR, TR-H, TR-HD

TYPES	Max. Energy Capacity		Stroke max. mm	Page
	¹ W ₃ Nm/cycle	Emergency Stop W ₃ Nm/cycle		
TR62-15HD	2,940	4,116	15	111
TR62-19HD	2,940	4,116	19	111
TR63-24HD	2,061	2,885	24	111
TR72-26HD	1,700	2,380	26	111
TR79-20HD	2,794	3,912	20	111
TR79-31HD	2,975	4,165	31	111
TR85-33HD	2,526	3,536	33	111
TR89-21HD	4,438	6,213	21	111
TR90-37HD	3,780	5,292	37	111
TR93-24HD	3,421	4,789	24	111
TR97-31HD	7,738	10,833	31	111
TR97-35HD	2,821	3,949	35	111
TR102-44HD	4,697	6,576	44	111
TR105-28HD	5,641	7,897	28	111
TR117-30HD	8,457	11,840	30	111

¹ Max. energy capacity per cycle for continuous use.

TUBUS TR-L

TYPES	Max. Energy Capacity		Stroke max. mm	Page
	¹ W ₃ Nm/cycle	Emergency Stop W ₃ Nm/cycle		
TR29-17L	7.2	10.9	17	109
TR43-25L	14.0	32.7	25	109
TR63-43L	21.9	32.0	43	109
TR66-40L-1	102.0	143.0	40	109
TR66-40L-2	204.0	286.0	40	109
TR66-40L-3	306.0	428.0	40	109
TR66-40L-4	408.0	571.0	40	109
TR66-40L-5	510.0	714.0	40	109
TR76-45L-1	145.0	203.0	45	109
TR76-45L-2	290.0	406.0	45	109
TR76-45L-3	435.0	609.0	45	109
TR76-45L-4	580.0	812.0	45	109
TR76-45L-5	725.0	1,015.0	45	109
TR83-48L-1	180.0	252.0	48	109
TR83-48L-2	360.0	504.0	48	109
TR83-48L-3	540.0	756.0	48	109
TR83-48L-4	720.0	1,008.0	48	109
TR83-48L-5	900.0	1,260.0	48	109
TR99-60L-1	270.0	378.0	60	109
TR99-60L-2	540.0	756.0	60	109
TR99-60L-3	810.0	1,134.0	60	109
TR99-60L-4	1,080.0	1,512.0	60	109
TR99-60L-5	1,350.0	1,890.0	60	109
TR99-60L-6	1,620.0	2,268.0	60	109
TR99-60L-7	1,890.0	2,646.0	60	109
TR143-86L-1	600.0	840.0	86	109
TR143-86L-2	1,200.0	1,680.0	86	109
TR143-86L-3	1,800.0	2,520.0	86	109
TR143-86L-4	2,400.0	3,360.0	86	109
TR143-86L-5	3,000.0	4,200.0	86	109
TR143-86L-6	3,600.0	5,040.0	86	109
TR143-86L-7	4,200.0	5,880.0	86	109
TR188-108L-1	1,100.0	1,540.0	108	109
TR188-108L-2	2,200.0	3,080.0	108	109
TR188-108L-3	3,300.0	4,620.0	108	109
TR188-108L-4	4,400.0	6,160.0	108	109
TR188-108L-5	5,500.0	7,700.0	108	109
TR188-108L-6	6,600.0	9,240.0	108	109
TR188-108L-7	7,700.0	10,780.0	108	109

¹ Max. energy capacity per cycle for continuous use.

Profile Dampers



TUBUS TA

Page 100

Axial Damping

Compact size and strong force absorption

Linear slides, Pneumatic cylinders, Handling modules, Machines and plants



TUBUS TS

Page 102

Axial Soft Damping

Compact size and smooth deceleration

Linear slides, Pneumatic cylinders, Handling modules, Machines and plants



TUBUS TR

Page 104

Radial Damping

Compact size and soft deceleration

Furniture industry, Sports equipment, Linear slides, Pneumatic cylinders



TUBUS TR-H

Page 106

Radial Damping, Hard Version

Compact size with soft deceleration and high energy absorption

Furniture industry, Sports equipment, Linear slides, Pneumatic cylinders



TUBUS TR-L

Page 108

Radial Damping, Long Version

Powerhouse in long body length

Offshore industry, Agricultural machinery, Impact panels, Conveyor systems



TUBUS TR-HD

Page 110

Radial Damping, Heavy Duty Version

Compact powerhouse in solid material

Offshore industry, Agricultural machinery, Impact panels, Conveyor systems

TUBUS TA

Compact size and strong force absorption

Axial Damping

Energy capacity 2 Nm/Cycle to 2,951 Nm/Cycle

Maximum stroke 5 mm bis 48 mm

Very efficient energy guzzlers: The TA profile dampers from the ACE TUBUS-Series are maintenance-free and ready to install. They consist of co-polyester elastomer; a material that only heats up slightly and ensures consistent damping. The TA models absorb a lot of energy at the start of the stroke.

The TA family has been specially developed for maximum energy absorption within a range of 2 Nm to 2,951 Nm. The minimum height is thanks to the space-saving shape with \varnothing 12 mm to \varnothing 116 mm. The dampers can be very easily and quickly fixed with the provided special screw.

These compact, cost-effective machine elements are ideal as end position dampers in linear axes, in toolmaking and tool machines, in hydraulic and pneumatic equipment, handling equipment and other applications.



Technical Data

Energy capacity: 2 Nm/Cycle to 2,951 Nm/Cycle

Energy absorption: 58 % to 73 %

Dynamic force range: 870 N to 90,000 N

Operating temperature range: -40 °C to +90 °C

Construction size: 12 mm to 116 mm

Mounting: In any position

Material hardness rating: Shore 55D

Material: Profile body: Co-Polyester Elastomer

Environment: Resistant to microbes, seawater or chemical attack. Excellent UV and

ozone resistance. Material does not absorb water or swell.

Impact velocity range: Max. 5 m/s

Torque max.:

M3: 1 Nm

M4: 1.7 Nm

M5: 2.3 Nm

M6: 6 Nm

M8: 20 Nm

M12: 50 Nm

M16: 120 Nm

Application field: Linear slides, Pneumatic cylinders, Handling modules, Machines and plants, Swivel units, Electro-mechanical

drives, Hydraulic devices, Conveyor systems, Crane systems

Note: Suitable for emergency stop applications and for continuous use. For applications with preloading and increased temperatures please consult ACE.

Safety instructions: Mounting screw should additionally be secured with Loctite.

On request: Special strokes, -characteristics, -spring rates, -sizes and -materials.

TA

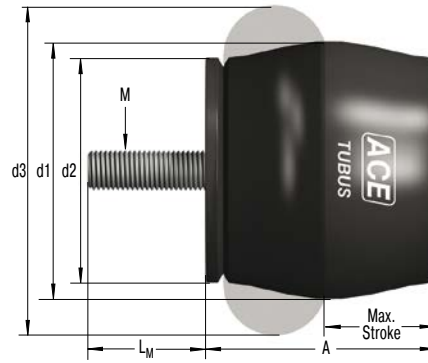

Characteristics

Type TA37-16
Energy-Stroke Characteristic (dynamic)
 (with impact velocity over 0.5 m/s)

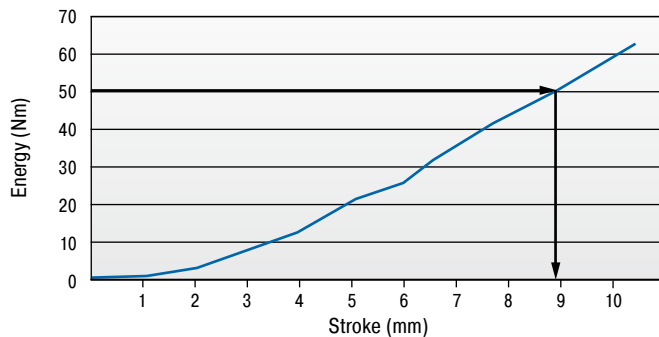

Type TA37-16
Force-Stroke Characteristic (dynamic)
 (with impact velocity over 0.5 m/s)

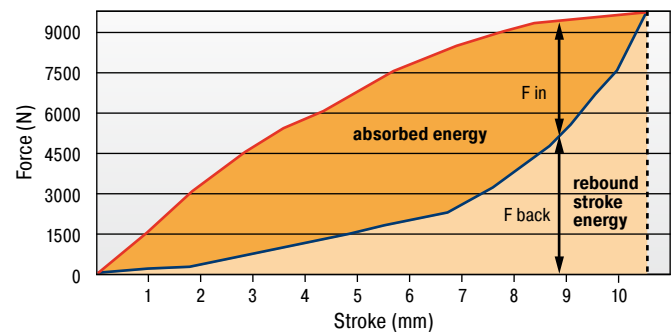

With the aid of the characteristic curves above you can estimate the proportion of the total energy that will be absorbed.
 Example: With impact energy of 50 Nm the Energy-Stroke diagram shows that a stroke of about 8.8 mm is needed.
 On the Force-Stroke diagram you can estimate the proportion of absorbed energy to rebound energy at this stroke length.
Dynamic ($v > 0.5$ m/s) and static ($v \leq 0.5$ m/s) characteristics of all types are available on request.

The calculation and selection of the most suitable damper should be carried out or be approved by ACE.

Ordering Example

TUBUS Axial _____ **TA37-16**
 Outer-Ø 37 mm _____
 Stroke 16 mm _____

Performance and Dimensions

TYPES	Emergency Stop		Stroke max. mm	A mm	d1 mm	d2 mm	d3 mm	L _M mm	M	Weight kg
	¹ W ₃ Nm/cycle	W ₃ Nm/cycle								
TA12-5	2.0	3	5	11	12	11	15	3	M3	0.001
TA17-7	6.0	9	7	16	17	15	22	4	M4	0.004
TA21-9	10.0	16	9	18	21	18	26	5	M5	0.007
TA22-10	11.5	21	10	19	22	19	27	6	M6	0.008
TA28-12	29.0	46	12	26	28	25	36	6	M6	0.016
TA34-14	48.0	87	14	30	34	30	43	6	M6	0.024
TA37-16	65.0	112	16	33	37	33	48	6	M6	0.030
TA40-16	82.0	130	16	35	40	34	50	8	M8	0.040
TA43-18	112.0	165	18	38	43	38	55	8	M8	0.051
TA47-20	140.0	173	20	41	47	41	60	12	M12	0.070
TA50-22	170.0	223	22	45	50	44	64	12	M12	0.085
TA54-22	201.0	334	22	47	54	47	68	12	M12	0.100
TA57-24	242.0	302	24	51	57	50	73	12	M12	0.116
TA62-25	304.0	361	25	54	62	53	78	12	M12	0.132
TA65-27	374.0	468	27	58	65	57	82	12	M12	0.153
TA70-29	421.0	524	29	61	70	60	86	12	M12	0.174
TA72-31	482.0	559	31	65	72	63	91	16	M16	0.257
TA80-32	570.0	831	32	69	80	69	100	16	M16	0.311
TA82-35	683.0	921	35	74	82	72	105	16	M16	0.350
TA85-36	797.0	1,043	36	76	85	75	110	16	M16	0.391
TA90-38	934.0	1,249	38	80	90	78	114	16	M16	0.414
TA98-40	1,147.0	1,555	40	86	98	85	123	16	M16	0.513
TA116-48	2,014.0	2,951	48	101	116	98	146	16	M16	0.803

¹ Max. energy capacity per cycle for continuous use.

TUBUS TS

Compact size and smooth deceleration

Axial Soft Damping

Energy capacity 2 Nm/Cycle to 966 Nm/Cycle

Maximum stroke 7 mm to 56 mm

Energy absorption in a compact and uniform way: The TS (TUBUS soft) profile dampers are also manufactured from co-polyester elastomer. Due to the almost linear damping characteristic curve, the maintenance-free, ready-to-install components softly absorb the energy with minimum strain on the machine. Consistent damping is helped by the low temperature increase of the material during operation.

The TS-Series impresses with maximum energy absorption within a range of 2 Nm to 966 Nm within a minimum height. The space-saving design has been implemented from Ø 14 mm to Ø 107 mm. The special screw supplied is used to simply and quickly fix the profile dampers in place.

Suitable for emergency stop and permanent applications, the cost-effective, durable TUBUS TS can be used as end position dampers in linear axes, in toolmaking and tool machines and in hydraulic, pneumatic and handling equipment.



Technical Data

Energy capacity: 2 Nm/Cycle to 966 Nm/Cycle

Energy absorption: 35 % to 64 %

Dynamic force range: 533 N to 23,500 N

Operating temperature range: -40 °C to +90 °C

Construction size: 14 mm to 107 mm

Mounting: In any position

Material hardness rating: Shore 40D

Material: Profile body: Co-Polyester Elastomer

Environment: Resistant to microbes, seawater or chemical attack. Excellent UV and

ozone resistance. Material does not absorb water or swell.

Impact velocity range: Max. 5 m/s

Torque max.:

M4: 1.7 Nm

M5: 2.3 Nm

M6: 6 Nm

M12: 50 Nm

M16: 120 Nm

Application field: Linear slides, Pneumatic cylinders, Handling modules, Machines and plants, Swivel units, Electro-mechanical drives, Crane systems, Conveyor systems, Crane systems

Note: Suitable for emergency stop applications and for continuous use. For applications with preloading and increased temperatures please consult ACE.

Safety instructions: Mounting screw should additionally be secured with Loctite.

On request: Special strokes, -characteristics, -spring rates, -sizes and -materials.

TS

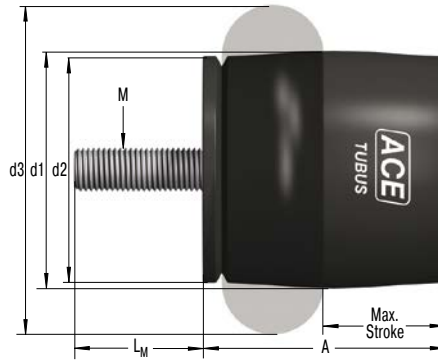

Characteristics

Type TS44-23
Energy-Stroke Characteristic (dynamic)
 (with impact velocity over 0.5 m/s)

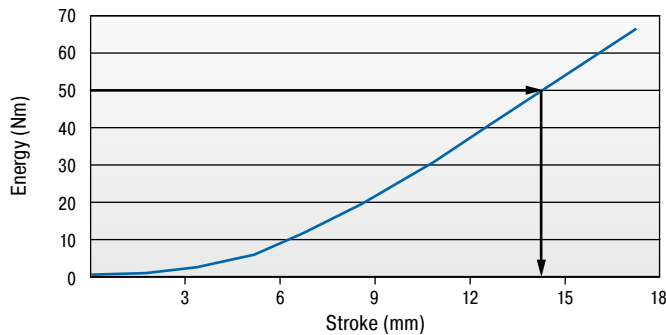

Type TS44-23
Force-Stroke Characteristic (dynamic)
 (with impact velocity over 0.5 m/s)

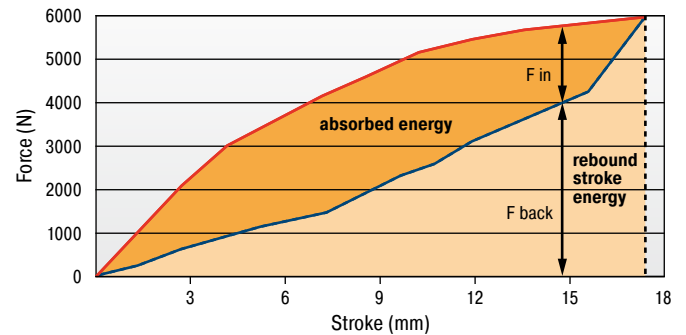

With the aid of the characteristic curves above you can estimate the proportion of the total energy that will be absorbed.
 Example: With impact energy of 50 Nm the Energy-Stroke diagram shows that a stroke of about 14 mm is needed.
 On the Force-Stroke diagram you can estimate the proportion of absorbed energy to rebound energy at this stroke length.
Dynamic ($v > 0.5$ m/s) and static ($v \leq 0.5$ m/s) characteristics of all types are available on request.

The calculation and selection of the most suitable damper should be carried out or be approved by ACE.

Ordering Example

TUBUS Axial Soft _____ **TS44-23**
 Outer-Ø 44 mm _____
 Stroke 23 mm _____

Performance and Dimensions

TYPES	Emergency Stop		Stroke max. mm	A mm	d1 mm	d2 mm	d3 mm	L _M mm	M	Weight kg
	¹ W ₃ Nm/cycle	W ₃ Nm/cycle								
TS14-7	2.0	3	7	15	14	13	19	4	M4	0.003
TS18-9	4.0	6	9	18	18	16	24	5	M5	0.006
TS20-10	6.0	7	10	21	20	19	27	6	M6	0.009
TS26-15	11.5	15	15	28	26	25	37	6	M6	0.016
TS32-16	23.0	26	16	32	32	30	44	6	M6	0.021
TS35-19	30.0	36	19	36	35	33	48	6	M6	0.028
TS40-19	34.0	42	19	38	40	34	51	6	M6	0.031
TS41-21	48.0	63	21	41	41	38	55	12	M12	0.060
TS44-23	63.0	72	23	45	44	40	60	12	M12	0.070
TS48-25	81.0	91	25	49	48	44	64	12	M12	0.080
TS51-27	92.0	114	27	52	51	47	69	12	M12	0.095
TS54-29	122.0	158	29	55	54	50	73	12	M12	0.105
TS58-30	149.0	154	30	59	58	53	78	12	M12	0.132
TS61-32	163.0	169	32	62	61	56	83	16	M16	0.203
TS64-34	208.0	254	34	66	64	60	87	16	M16	0.232
TS68-36	227.0	272	36	69	68	63	92	16	M16	0.248
TS75-39	291.0	408	39	75	75	69	101	16	M16	0.301
TS78-40	352.0	459	40	79	78	72	105	16	M16	0.339
TS82-44	419.0	620	44	84	82	75	110	16	M16	0.346
TS84-43	475.0	635	43	85	84	78	115	16	M16	0.402
TS90-47	580.0	778	47	92	90	84	124	16	M16	0.490
TS107-56	902.0	966	56	110	107	100	147	16	M16	0.733

¹ Max. energy capacity per cycle for continuous use.

TUBUS TR

Compact size and soft deceleration

Radial Damping

Energy capacity 1.2 Nm/Cycle to 146 Nm/Cycle

Maximum stroke 17 mm bis 60 mm

For long, soft braking action: The Radial damping forces in this model from the ACE TUBUS-Series provides the TR range. These maintenance-free, ready-to-install elements are made of co-polyester elastomer, which only heats up slightly during operation and therefore provides consistent damping.

The radial loading enables a very long and soft deceleration with progressive energy reduction at the end of the stroke. The TR-Series has been specially designed for maximum stroke with a minimum height, producing an energy absorption per stroke extending from 1.2 Nm to 146 Nm. The dampers are available in compact formats of Ø 29 mm to Ø 100 mm and are supplied with a special screw for simple, quick assembly.

The TUBUS TR products are suitable as end position dampers in linear axes, in toolmaking and tool machines, in hydraulic and pneumatic equipment, handling equipment and other applications.



Technical Data

Energy capacity: 1.2 Nm/Cycle to 146 Nm/Cycle

Energy absorption: 25 % to 45 %

Dynamic force range: 218 N to 7,500 N

Operating temperature range: -40 °C to +90 °C

Construction size: 29 mm to 100 mm

Mounting: In any position

Material hardness rating: Shore 40D

Material: Profile body: Co-Polyester Elastomer

Environment: Resistant to microbes, seawater or chemical attack. Excellent UV and ozone resistance. Material does not absorb water or swell.

Impact velocity range: Max. 5 m/s

Torque max.:

M5: 3 Nm

M6: 6 Nm

M8: 20 Nm

Application field: Furniture industry, Sports equipment, Linear slides, Pneumatic cylinders, Handling modules, Machines and plants, Stacking units, Electro-mechanical drives, Conveyor systems

Note: Suitable for emergency stop applications and for continuous use. For applications with preloading and increased temperatures please consult ACE.

Safety instructions: Mounting screw should additionally be secured with Loctite.

On request: Special strokes, -characteristics, -spring rates, -sizes and -materials.

TR

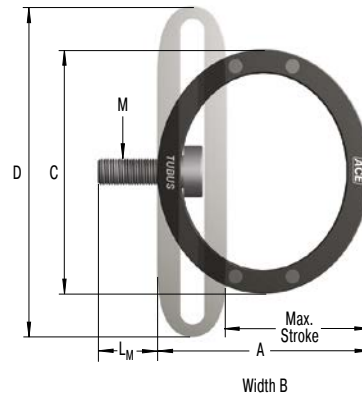

Characteristics

Type TR93-57

Energy-Stroke Characteristic (dynamic)
(with impact velocity over 0.5 m/s)

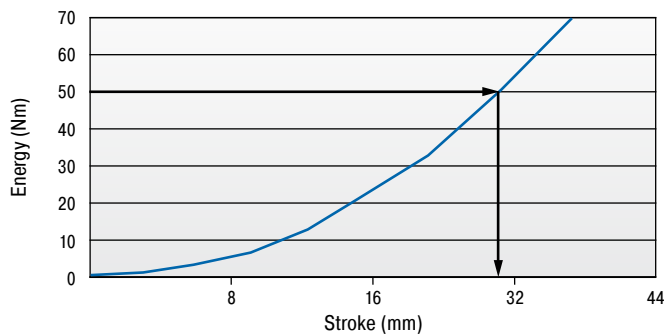

Type TR93-57

Force-Stroke Characteristic (dynamic)
(with impact velocity over 0.5 m/s)

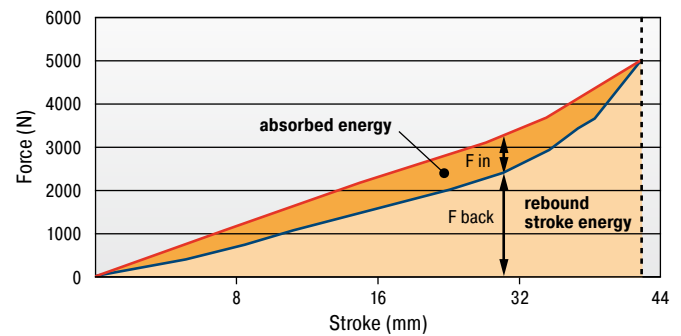

With the aid of the characteristic curves above you can estimate the proportion of the total energy that will be absorbed.
Example: With impact energy of 50 Nm the Energy-Stroke diagram shows that a stroke of about 31 mm is needed.
On the Force-Stroke diagram you can estimate the proportion of absorbed energy to rebound energy at this stroke length.
Dynamic ($v > 0.5$ m/s) and static ($v \leq 0.5$ m/s) characteristics of all types are available on request.

The calculation and selection of the most suitable damper should be carried out or be approved by ACE.

Ordering Example

TUBUS Radial _____ **TR93-57**
Outer-Ø 93 mm _____
Stroke 57 mm _____

Performance and Dimensions

TYPES	Emergency Stop		Stroke max. mm	A mm	B mm	C mm	D mm	L _M mm	M	Weight kg
	¹ W _s Nm/cycle	W _s Nm/cycle								
TR29-17	1.2	1.8	17	25	13	29	38	5	M5	0.010
TR37-22	2.3	5.4	22	32	19	37	50	5	M5	0.013
TR43-25	3.5	8.1	25	37	20	43	58	5	M5	0.017
TR50-35	5.8	8.3	35	44	34	50	68	5	M5	0.025
TR63-43	12.0	17.0	43	55	43	63	87	5	M5	0.051
TR67-40	23.0	33.0	40	59	46	67	88	5	M5	0.089
TR76-46	34.5	43.0	46	67	46	76	102	6	M6	0.104
TR83-50	45.0	74.0	50	73	51	83	109	6	M6	0.142
TR85-50	68.0	92.0	50	73	68	85	111	8	M8	0.206
TR93-57	92.0	122.0	57	83	83	93	124	8	M8	0.297
TR100-60	115.0	146.0	60	88	82	100	133	8	M8	0.308

¹ Max. energy capacity per cycle for continuous use.

TUBUS TR-H

Compact size with soft deceleration and high energy absorption

Radial Damping, Hard Version

Energy capacity 2.7 Nm/Cycle to 427 Nm/Cycle

Maximum stroke 15 mm bis 56 mm

Harder mixture of materials for higher energy absorption: The maintenance-free and ready-to-install TR-H-Series profile dampers, are stressed radially in the same way as the basic TR model. With almost the same dimensions, they also decelerate with a very long and soft action. The harder co-polyester elastomer mixture leads to significantly high energy absorption of 2.7 Nm to 427 Nm in these models. Easy to mount due to the supplied special screw.

The TR-H-Series is space-saving with dimensions of \varnothing 30 mm to \varnothing 102 mm. It complements the TUBUS range between the progressive TR and almost linear TS models. Users are therefore provided with a full range of deceleration curves within the ACE TUBUS family.

The TUBUS TR-H products are suitable end position dampers in linear axes, in toolmaking and tool machines and in hydraulic, pneumatic and handling equipment as well as other applications.



Technical Data

Energy capacity: 2.7 Nm/Cycle to 427 Nm/Cycle

Energy absorption: 39 % to 62 %

Dynamic force range: 550 N to 21,200 N

Operating temperature range: -40 °C to +90 °C

Construction size: 30 mm to 102 mm

Mounting: In any position

Material hardness rating: Shore 55D

Material: Profile body: Co-Polyester Elastomer

Environment: Resistant to microbes, seawater or chemical attack. Excellent UV and

ozone resistance. Material does not absorb water or swell.

Impact velocity range: Max. 5 m/s

Torque max.:

M5: 3 Nm

M6: 6 Nm

M8: 20 Nm

Application field: Furniture industry, Sports equipment, Linear slides, Pneumatic cylinders, Handling modules, Machines and plants, Stacking units, Electro-mechanical drives, Conveyor systems

Note: Suitable for emergency stop applications and for continuous use. For applications

with preloading and increased temperatures please consult ACE.

Safety instructions: Mounting screw should additionally be secured with Loctite.

On request: Special strokes, -characteristics, -spring rates, -sizes and -materials.

TR-H

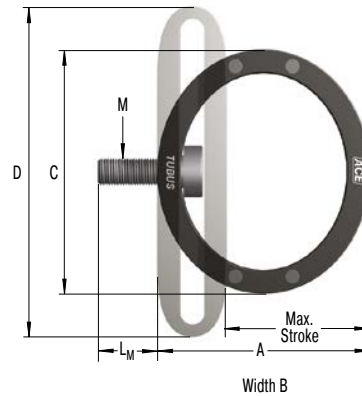

Characteristics

Type TR95-50H

Energy-Stroke Characteristic (dynamic)
(with impact velocity over 0.5 m/s)

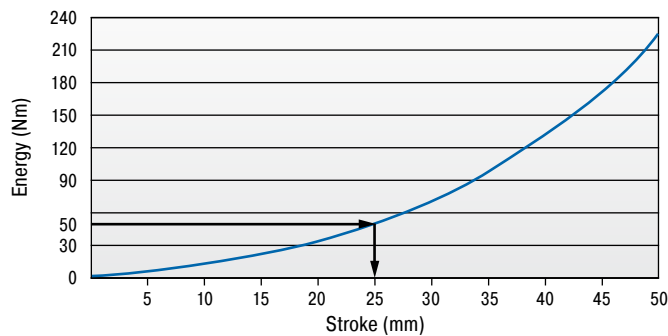

Type TR95-50H

Force-Stroke Characteristic (dynamic)
(with impact velocity over 0.5 m/s)

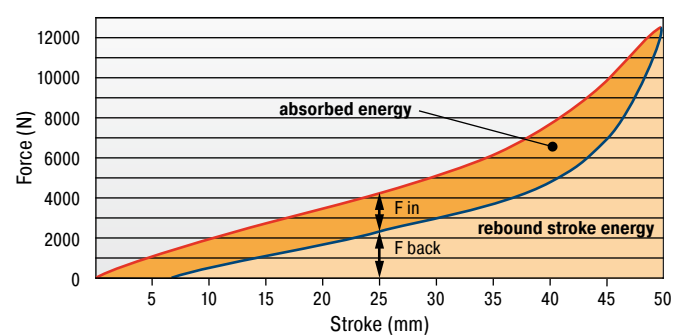

With the aid of the characteristic curves above you can estimate the proportion of the total energy that will be absorbed.
 Example: With impact energy of 50 Nm the Energy-Stroke diagram shows that a stroke of about 25 mm is needed.
 On the Force-Stroke diagram you can estimate the proportion of absorbed energy to rebound energy at this stroke length.
Dynamic ($v > 0.5$ m/s) and static ($v \leq 0.5$ m/s) characteristics of all types are available on request.

The calculation and selection of the most suitable damper should be carried out or be approved by ACE.

Ordering Example

TUBUS Radial _____ ↑ ↑ ↑
 Outer-Ø 95 mm _____ ↑
 Stroke 50 mm _____ ↑
 Hard Version _____ ↑

TR95-50H

Performance and Dimensions

TYPES	Emergency Stop		Stroke max. mm	A mm	B mm	C mm	D mm	L _M mm	M	Weight kg
	¹ W _s Nm/cycle	W _s Nm/cycle								
TR30-15H	2.7	5.7	15	23	13	30	38	5	M5	0.009
TR39-19H	6.0	18.0	19	30	19	39	50	5	M5	0.013
TR45-23H	8.7	24.0	23	36	20	45	58	5	M5	0.019
TR52-32H	11.7	20.0	32	42	34	52	68	5	M5	0.030
TR64-41H	25.0	46.0	41	53	43	64	87	5	M5	0.054
TR68-37H	66.5	98.0	37	56	46	68	88	5	M5	0.095
TR79-42H	81.5	106.0	42	64	46	79	102	6	M6	0.107
TR86-45H	124.0	206.0	45	69	51	86	109	6	M6	0.152
TR87-46H	158.0	261.0	46	68	67	86	111	8	M8	0.188
TR95-50H	228.0	342.0	50	77	82	95	124	8	M8	0.281
TR102-56H	290.0	427.0	56	84	81	102	133	8	M8	0.334

¹ Max. energy capacity per cycle for continuous use.

TUBUS TR-L

Powerhouse in long body length

Radial Damping, Long Version

Energy capacity 7.2 Nm/Cycle to 10,780 Nm/Cycle

Maximum stroke 17 mm bis 108 mm

Especially for applications with long and soft deceleration: The radial tube dampers TR-L from the ACE TUBUS-Series are maintenance-free, ready-to-install elements made of co-polyester elastomer.

Their radial load offers designers a very long and soft deceleration with a progressive reduction in energy at the end of the stroke. The TR-L-Series has been specially developed for a maximum stroke with a minimum height and a range of 7.2 Nm to 10,780 Nm. The absorption capacity is dependent on the length of the selected tube damper. These models are available in sizes between \varnothing 29 mm and \varnothing 188 mm.

The TUBUS TR-L is used where impact or collision protection is necessary along a straight line e.g. on shovels in mining equipment, loading and lifting devices, dock systems in shipbuilding or luggage and transport belts.

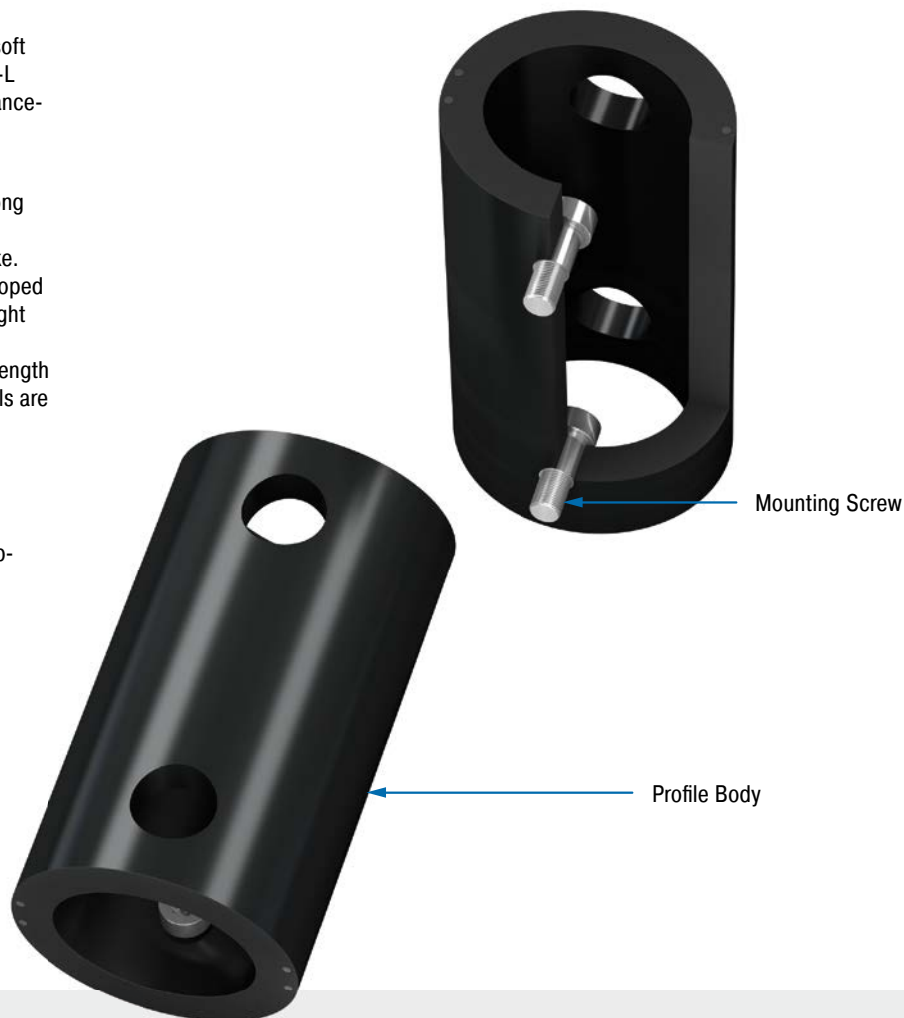

Technical Data

Energy capacity: 7.2 Nm/Cycle to 10,780 Nm/Cycle

Energy absorption: 26 % to 41 %

Dynamic force range: 1,312 N to 217,700 N

Operating temperature range: -40 °C to +90 °C

Construction size: 29 mm to 188 mm

Mounting: In any position

Material hardness rating: Shore 55D

Material: Profile body: Co-Polyester Elastomer

Environment: Resistant to microbes, seawater or chemical attack. Excellent UV and

ozone resistance. Material does not absorb water or swell.

Impact velocity range: Max. 5 m/s

Torque max.:

M5: 3 Nm

M8: 20 Nm

M16: 40 Nm (DIN912)

M16: 120 Nm (shouldered screw)

Application field: Offshore industry, Agricultural machinery, Impact panels, Conveyor systems, Stacking units, Shipbuilding, Shovels or articulated joints for construction machinery, Transport roads, Loading and lifting equipment

Note: Suitable for emergency stop applications and for continuous use. For applications with preloading and increased temperatures please consult ACE.

Safety instructions: Mounting screw should additionally be secured with Loctite.

On request: Special strokes, -characteristics, -spring rates, -sizes and -materials.

TR-L

(middle hole only TR-L-5/6/7)

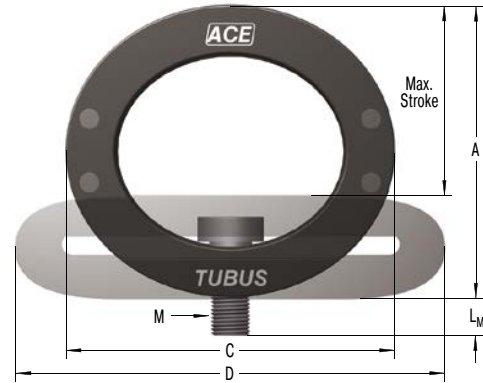
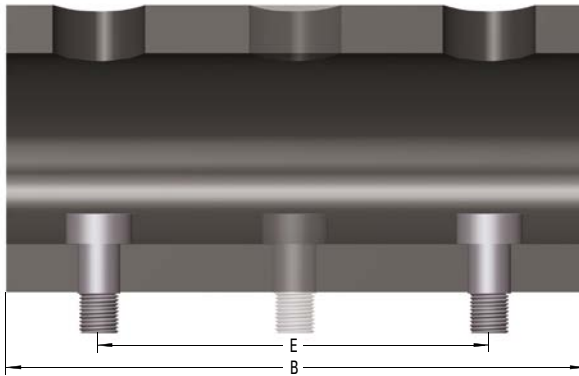

The calculation and selection of the most suitable damper should be carried out or be approved by ACE.

Ordering Example

TR66-40L-2

TUBUS Radial _____
 Outer-Ø 66 mm _____
 Stroke 40 mm _____
 Long Version _____
 Length 2 = 305 mm _____

Performance and Dimensions

TYPES	Emergency Stop		Stroke max. mm	A mm	B mm	C mm	D mm	E mm	L _M mm	M	Weight kg
	¹ W _s Nm/cycle	W _s Nm/cycle									
TR29-17L	7.2	10.9	17	25	80	29	38	40	5	M5	0.044
TR43-25L	14.0	32.7	25	37	80	43	58	40	5	M5	0.072
TR63-43L	21.9	32.0	43	55	80	63	87	40	5	M5	0.106
TR66-40L-1	102.0	143.0	40	59	152	66	87	102	8	M8	0.284
TR66-40L-2	204.0	286.0	40	59	305	66	87	254	8	M8	0.580
TR66-40L-3	306.0	428.0	40	59	457	66	87	406	8	M8	0.830
TR66-40L-4	408.0	571.0	40	59	610	66	87	559	8	M8	1.130
TR66-40L-5	510.0	714.0	40	59	762	66	87	711	8	M8	1.330
TR76-45L-1	145.0	203.0	45	68	152	76	100	102	8	M8	0.380
TR76-45L-2	290.0	406.0	45	68	305	76	100	254	8	M8	0.696
TR76-45L-3	435.0	609.0	45	68	457	76	100	406	8	M8	1.130
TR76-45L-4	580.0	812.0	45	68	610	76	100	559	8	M8	1.430
TR76-45L-5	725.0	1,015.0	45	68	762	76	100	711	8	M8	1.780
TR83-48L-1	180.0	252.0	48	73	152	83	106	102	8	M8	0.480
TR83-48L-2	360.0	504.0	48	73	305	83	106	254	8	M8	0.930
TR83-48L-3	540.0	756.0	48	73	457	83	106	406	8	M8	1.380
TR83-48L-4	720.0	1,008.0	48	73	610	83	106	559	8	M8	1.810
TR83-48L-5	900.0	1,260.0	48	73	762	83	106	711	8	M8	2.260
TR99-60L-1	270.0	378.0	60	88	152	99	130	102	8	M8	0.790
TR99-60L-2	540.0	756.0	60	88	305	99	130	254	8	M8	1.290
TR99-60L-3	810.0	1,134.0	60	88	457	99	130	406	8	M8	1.940
TR99-60L-4	1,080.0	1,512.0	60	88	610	99	130	559	8	M8	2.660
TR99-60L-5	1,350.0	1,890.0	60	88	762	99	130	711	8	M8	3.100
TR99-60L-6	1,620.0	2,268.0	60	88	914	99	130	864	8	M8	3.700
TR99-60L-7	1,890.0	2,646.0	60	88	1,067	99	130	1,016	8	M8	4.300
TR143-86L-1	600.0	840.0	86	127	152	143	191	76	22	M16	1.440
TR143-86L-2	1,200.0	1,680.0	86	127	305	143	191	203	22	M16	2.900
TR143-86L-3	1,800.0	2,520.0	86	127	457	143	191	355	22	M16	3.880
TR143-86L-4	2,400.0	3,360.0	86	127	610	143	191	508	22	M16	5.420
TR143-86L-5	3,000.0	4,200.0	86	127	762	143	191	660	22	M16	6.590
TR143-86L-6	3,600.0	5,040.0	86	127	914	143	191	812	22	M16	7.890
TR143-86L-7	4,200.0	5,880.0	86	127	1,067	143	191	965	22	M16	9.190
TR188-108L-1	1,100.0	1,540.0	108	165	152	188	245	76	26	M16	2.340
TR188-108L-2	2,200.0	3,080.0	108	165	305	188	245	203	26	M16	4.640
TR188-108L-3	3,300.0	4,620.0	108	165	457	188	245	355	26	M16	6.890
TR188-108L-4	4,400.0	6,160.0	108	165	610	188	245	508	26	M16	9.190
TR188-108L-5	5,500.0	7,700.0	108	165	762	188	245	660	26	M16	11.390
TR188-108L-6	6,600.0	9,240.0	108	165	914	188	245	812	26	M16	13.640
TR188-108L-7	7,700.0	10,780.0	108	165	1,067	188	245	965	26	M16	15.940

¹ Max. energy capacity per cycle for continuous use.

TUBUS TR-HD

Compact powerhouse in solid material

Radial Damping, Heavy Duty Version

Energy capacity 405 Nm/Cycle to 11,840 Nm/Cycle

Maximum stroke 12 mm to 44 mm

Impact and collision protection: The TR-HD profile dampers are stressed in the same way as the basic model TR but offer a higher force and energy absorption with a shorter damping distance thanks to the solid design. Different damping characteristic curves can be achieved with two different co-polyester elastomer hardness levels. The slightly oval (bi-concave) shape also ensures a softer force intake.

This series absorbs a lot of energy despite the low height: a range of 405 Nm to 11,840 Nm is progressively covered by strokes of 12 mm to 44 mm. With two screws, included in the delivery, the damper can be easily and quickly fixed both horizontally or vertically. The drill hole distance is adapted if required.

These dampers are used in agricultural technology and on shovels or break joints on construction machines as well as on loading and lifting or similar equipment.



Technical Data

Energy capacity: 405 Nm/Cycle to 11,840 Nm/Cycle

Energy absorption: 43 % to 72 %

Dynamic force range: 78.800 N to 812,900 N

Operating temperature range: -40 °C to +90 °C

Construction size: 42 mm to 117 mm

Mounting: In any position

Material hardness rating: Shore 40D, Shore 55D

Material: Profile body: Co-Polyester Elastomer

Environment: Resistant to microbes, seawater or chemical attack. Excellent UV and ozone resistance. Material does not absorb water or swell.

Impact velocity range: Max. 5 m/s

Torque max.:

M10: 7 Nm

M12: 12 Nm

Application field: Offshore industry, Agricultural machinery, Impact panels, Conveyor systems, Stacking units, Shipbuilding, Shovels or articulated joints for construction machinery, Transport roads, Loading and lifting equipment

Note: Suitable for emergency stop applications and for continuous use. For applications with preloading and increased temperatures please consult ACE.

Safety instructions: Mounting screw should additionally be secured with Loctite.

On request: Special strokes, -characteristics, -spring rates, -sizes and -materials.

TR-HD

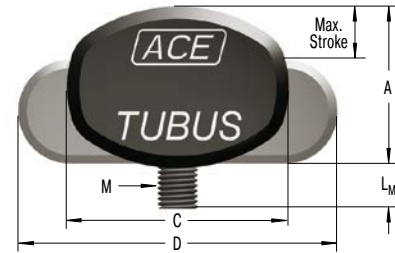
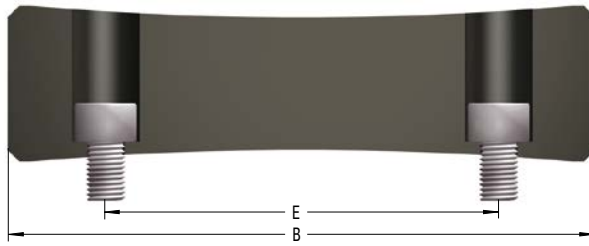

Characteristics

TUBUS TR-HD

Force-Stroke Characteristics (static)

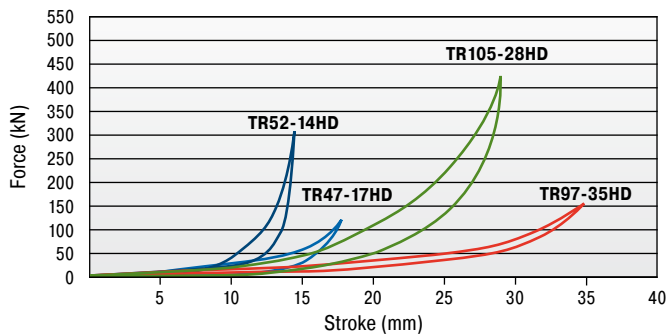

The calculation and selection of the most suitable damper should be carried out or be approved by ACE.

Ordering Example

TUBUS Radial _____
 Outer-Ø 63 mm _____
 Stroke 24 mm _____
 Heavy Duty Version _____

TR63-24HD

Performance and Dimensions

TYPES	Emergency Stop		F max. static N	Stroke max. mm	A mm	B mm	C mm	D mm	E mm	L _M mm	M	Weight kg
	¹ W ₃ Nm/cycle	W ₃ Nm/cycle										
TR42-14HD	405	567	63,900	14	34	148	42	59	102	20	M10	0.170
TR47-12HD	857	1,200	149,600	12	31	150	47	58	102	19	M10	0.170
TR47-17HD	850	1,190	122,100	17	32	150	47	70	102	24	M10	0.180
TR52-14HD	1,634	2,288	304,500	14	29	153	52	69	102	22	M10	0.180
TR57-21HD	1,194	1,672	104,800	21	48	149	57	79	102	18	M10	0.340
TR62-15HD	1,790	2,506	245,000	15	40	153	62	77	102	16	M10	0.330
TR62-19HD	2,940	4,116	389,900	19	41	152	62	94	102	16	M10	0.360
TR63-24HD	2,061	2,885	194,400	24	46	153	63	92	102	20	M10	0.330
TR72-26HD	1,700	2,380	124,800	26	59	149	72	98	102	23	M12	0.560
TR79-20HD	2,794	3,912	289,300	20	54	153	79	98	102	24	M12	0.570
TR79-31HD	2,975	4,165	226,600	31	58	155	79	112	102	23	M12	0.560
TR85-33HD	2,526	3,536	146,100	33	71	150	85	111	102	23	M12	0.710
TR89-21HD	4,438	6,213	477,400	21	48	162	89	112	102	22	M12	0.560
TR90-37HD	3,780	5,292	240,700	37	69	155	90	128	102	23	M12	0.750
TR93-24HD	3,421	4,789	302,500	24	64	155	93	115	102	23	M12	0.790
TR97-31HD	7,738	10,833	575,200	31	63	159	97	129	102	21	M12	0.800
TR97-35HD	2,821	3,949	152,800	35	82	151	97	131	102	20	M12	1.060
TR102-44HD	4,697	6,576	254,500	44	81	156	102	147	102	22	M12	1.050
TR105-28HD	5,641	7,897	427,600	28	72	156	105	126	102	21	M12	1.000
TR117-30HD	8,457	11,840	639,100	30	66	166	117	143	102	25	M12	1.010

¹ Max. energy capacity per cycle for continuous use.

Application Examples

TUBUS TA

Safe end position damping

ACE TUBUS profile dampers protect the integrated loading station on a new high speed machining centre. The ACE TUBUS damper is designed to prevent overrun on the high speed loading station of a Camshaft machining centre used in the automobile industry. In the event that the drive train fails during operation or incorrect data is inputted the ACE TUBUS damper absorbs the impact preventing costly damage to the machine. The TA98-40 TUBUS damper impressed engineers with this exceptionally long service life in operation. When used as an emergency stop the TUBUS damper can absorb up to 73 % of the impact energy.



Safety with ultra high speed operation

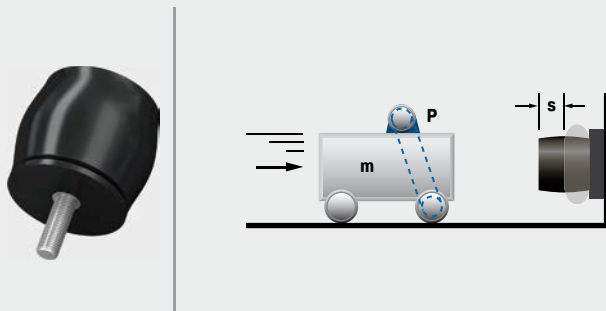

TUBUS TS

Safe braking of maintenance boats

The maintenance of wind turbines in open seas has long resulted in damage to maintenance boats. Because of impact velocity and swell, an increase in the boat's mass of up to 20 percent must be taken into account when landing on a rigid mooring structure. It is only since the landing operation has been carried out with the aid of the ACE company's TUBUS series that cable repair and maintenance work on wind turbines has been made safe for both personnel and equipment. TUBUS of the type TS84-43 are seawater resistant and can withstand ambient temperatures from -40 °C to + 90 °C.



Seawater-resistant, robust TUBUS profile dampers made of co-polyester elastomer allow boats and crew to dock safely
Wals Diving and Marine Service, 1970AC Ijmuiden, Netherlands

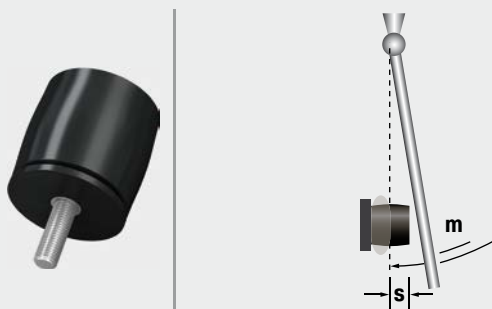

Issue 07.2017 – Specifications subject to change

TUBUS TS

Protection of drive used in space treadmill

When training in zero gravity, a harness with bungee cords is used to ensure that trainees do not become disengaged. Three ACE profile dampers with a linear-working facility are utilized in this case. One so-called TUBUS is positioned in the pneumatic cylinder, while the other two are put in place in the rest of the system. All the dampers have the task of protecting the system if the treadmill drive belts become damaged. Otherwise, the cylinder would reach a very high speed and become seriously damaged at the end of the stroke.



TUBUS are used to protect a fitness machine in zero gravity
QinetiQ Space nv, 9150 Kruibeke, Belgium

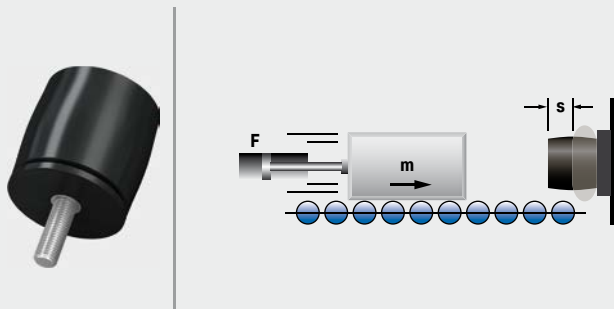

TUBUS TR

Gentle damping for electric scooters

TUBUS profile dampers make driving an e-scooter a real experience. The footboard of an electric scooter should be dampened to enable the driver to experience a comfortable ride even over potholes and other bumpy surfaces. Ideally, the characteristic line should be furnished with a soft increase in force over a long stroke. The elegant look of the scooter as well as the folding mechanism designed to save space have not allowed the use of feasible damper solutions up to now. Inferior alternatives such as rubber dampers made of polyurethane or simple steel springs could not be considered from the start. The TUBUS profile damper TR52-32H offered the perfect solution with its compact construction design paired with progressive damping action.



Profile dampers increase the riding comfort of an electric scooter

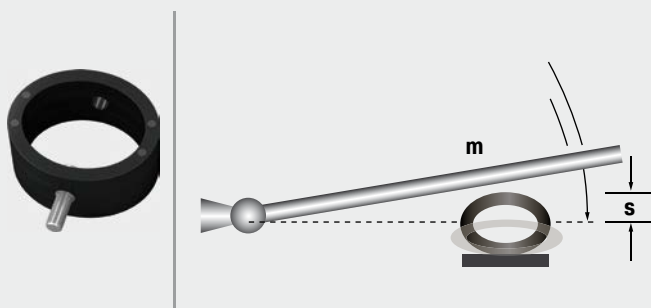

Special Profile Dampers

Costs-effective tuning for your pressing tools

ACE provides TUBUS profile dampers in many variations. Special solutions for presses can now be cost-effectively achieved with down holder dampers, damping plugs, lift dampers and press dampers from ACE.

They replace the PU-springs previously used in the automotive industry. It was no longer possible for them to fulfil the required tasks due to the higher return stroke speeds in modern pressing tools. Made of co-polyester elastomers, the TUBUS special takes care of the protection of mounting bolts and insert bolts much more reliably. On the one hand they protect a so-called down holders during the return stroke after the forming of sheet metal parts, and on the other they function as protection for hoisting lifters.

High reliability

Long service life

High power and energy absorption

Efficient working through higher cycle rates

Extreme abrasion hardness and shear strength

Noise reduction



TUBUS Special Profile Dampers

A wide range of solutions for your tools

Small but effective: These versatile, custom-manufactured components make all the difference during sheet metal forming in the automotive and tool industries thanks to long service lives and high power absorption.



TUBUS Down Holder Dampers

The innovation as a substitute for overburdened PU springs

The axial-functioning elements are ideal for different diameters of mounting bolts from M10 to M30 in the press tools. They increase clock rates, service lives and reliability during increased cushioning strokes there.



TUBUS Lift Dampers

The brother of the down holder damper

Used in the end position damping in ProgDie presses, they sit on the mounting bolts of the spring-loaded belt guide rails or hoisting lifters in the bottom part of the tool of the follow-on composite tool, protect it and accelerate production.



TUBUS Damping Plugs

A special kind of emergency plug

These side-mounted, radial damping elements also protect the mounting bolts and insert bolts during the opening of the pressing tools. They are available in four different sizes and are used in large tools.



TUBUS Press Dampers

When a side effect (nearly) becomes the main thing

All TUBUS specials additionally reduce noise. In press dampers, used particularly in eccentric presses by manufacturers of large household appliances, this is however the main task. Screwed into a hole pocket, they also effectively protect the tools.

More information about TUBUS special profile dampers can be found in our special catalogue and on our Website

[www.ace-ace.com / Downloads](http://www.ace-ace.com/Downloads)

Damping Pads

Customised damping technology

With damping pads from the SLAB series, ACE provides solutions to effectively slow down impact loads over large and small surfaces. This means that these products are found in a wide range of damping technologies from ACE where oscillation begins or where damaging impacts in construction designs need to be slowed over a large surface.

The ACE SLAB pads, available to choose in any size, absorb static loads from 3 N/cm^2 to 30 N/cm^2 and can be either cut to size two-dimensionally according to each requirement or designed as a moulded part. It is simply adhered to assemble. The standard plate heights are between 12.5 mm and 25 mm. Many different coatings clear the way for numerous applications and not least because they can be used in a temperature range from $-5 \text{ }^\circ\text{C}$ to $+50 \text{ }^\circ\text{C}$.

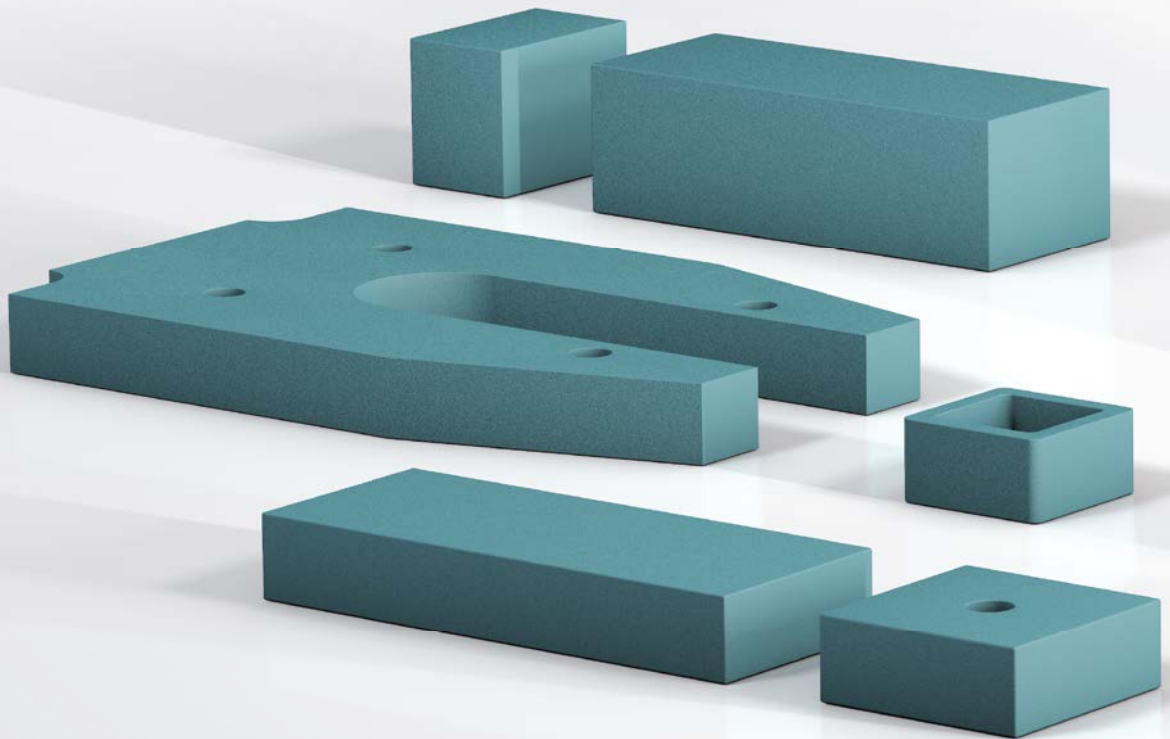

Individual Pad Cutting

SLAB pads pre-assembled for each project

Whether pads, cuts or drawing parts, stocked SLAB pads in combination with our freely programmable cutting machine ensure maximum flexibility with excellent delivery speed.

Fast, flexible and adapted to your conditions.

Ask for special solutions !!!

Can be integrated quickly and cost-effectively

Immense inner damping

Pad thicknesses up to 80 mm on request

Can be assembled with CNC cutting machines

Patented formula

Environmentally-friendly H₂O-foamed

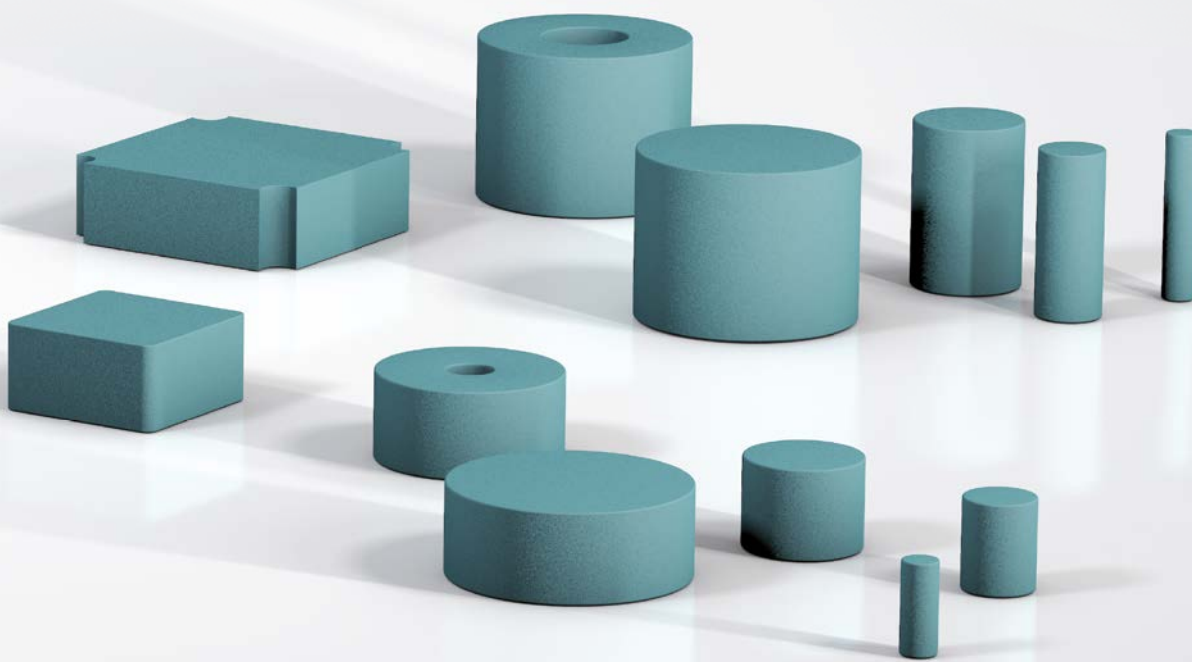

SLAB 030 to SLAB 300

Energy absorption in pad format

Confectioning and Combinable

Energy capacity 3.1 Nm/Cycle to 210 Nm/Cycle

Stroke 6.5 mm to 12.5 mm

Tailor made damping material in pad format: SLAB damping pads are made of a viscoelastic PUR-material. They absorb impact loads extremely effectively and are also suitable for insulating or damping vibration.

The pad series SL-030 to SL-300 are quickly adapted to the relevant type of application. This is in part achieved through the configuration of the calculating tool or directly by the ACE specialist engineers. Furthermore, this is possible because the standard material can be cut exactly and quickly to any customer requirement with our new cutting system. It is also possible to obtain a sample to find an optimum solution.

The SLAB damping pads are proven impact or collision protection. They are used on luggage and transport belts, conveyor systems, pneumatic, electromechanical and hydraulic drives as well as on linear carriages.

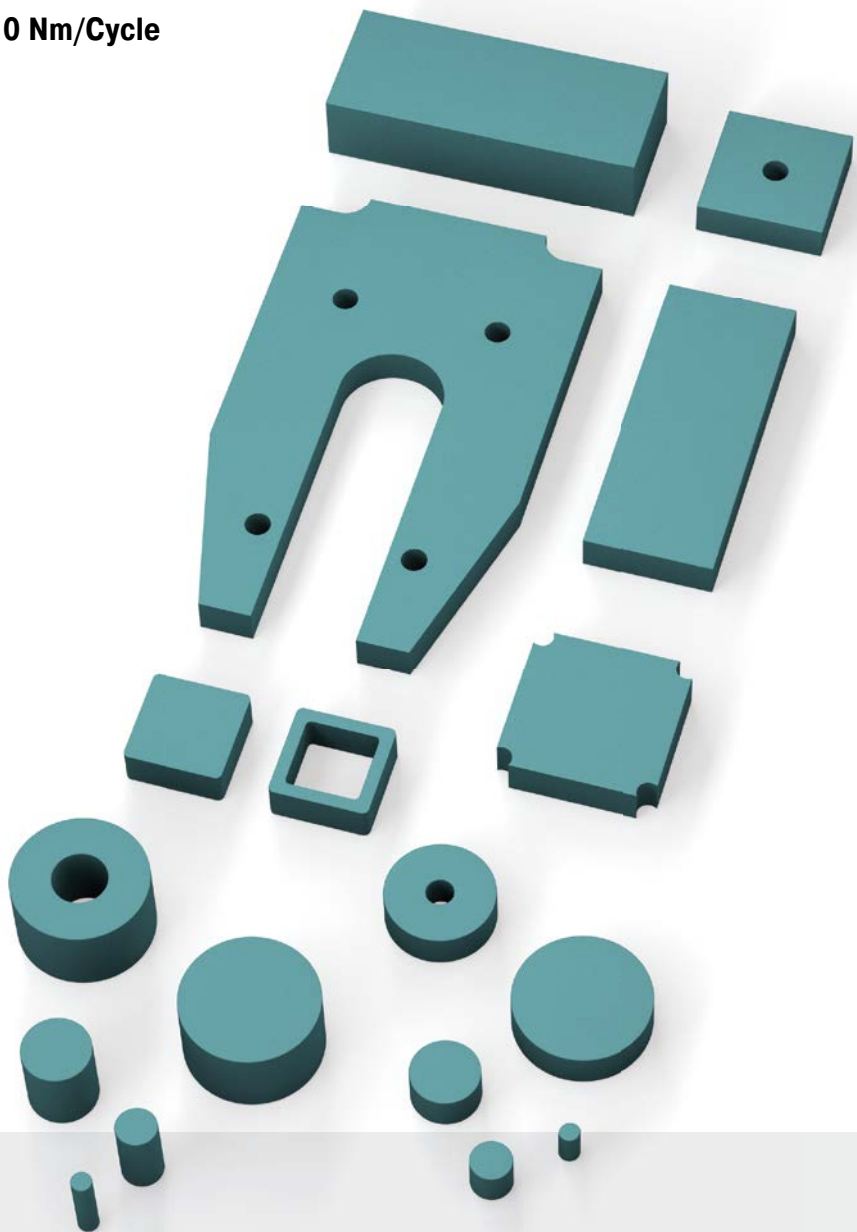

Technical Data

Energy capacity: 3.1 Nm/Cycle to 210 Nm/Cycle

Standard density:

SL-030 = approx. 220 kg/m³

SL-100 = approx. 440 kg/m³

SL-300 = approx. 680 kg/m³

Standard colour: Green

Dimensions:

Widths: up to 1,500 mm

Lengths: up to 5,000 mm

Thicknesses: 12.5 mm and 25 mm

Environment: Resistant against ozone and UV radiation. Chemical resistancy on request.

Operating temperature range: -5 °C to +50 °C

Material: Profile body: Mixed cellular PUR-Elastomer (polyurethane)

Application field: Linear slides, Handling modules, Luggage and transport belts, Impact panels, Pipeline insulation, Foundation mounting, Conveyor technology, Electronic systems and controls, Medical technology

Note: Possibilities for cutting: Water jet cutting, stamping, splitting, sawing and drilling

Safety instructions: Fire rating: B2, normally flammable, according to DIN 4102

On request: Special versions with further dimensions such as thicknesses, colours, shapes and drawing parts e.g. curves. Different wear layers.

SL-030-12

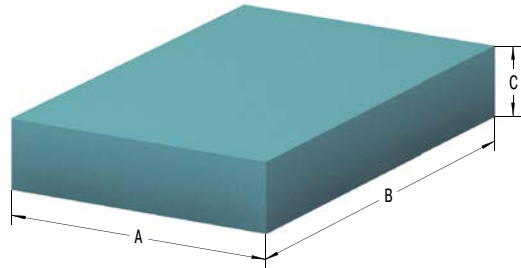

Characteristics

Type SL-030-12

Force-Stroke Characteristic (dynamic)

Stroke Utilization 6.5 mm

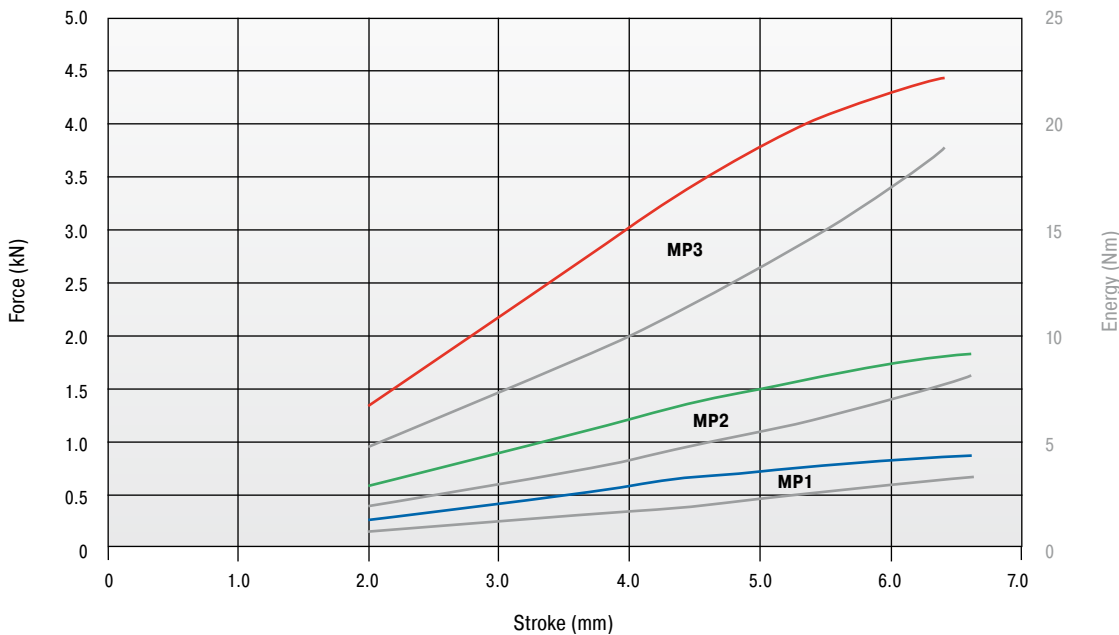

Load data

Dynamic load, impact velocity: approx. 1 m/s



The chosen damping plate should be tested by the customer on the specific application.

Ordering Example

ACE-SLAB _____ **SL-030-12-Dxxxx**
 Material Type _____
 Material Thickness 12.5 mm _____
 Customers Specific Dimension/Shape _____
 (D-Number is assigned by ACE)

Performance and Dimensions

TYPES	¹ W ₃ max. Nm/cycle	¹ Stroke mm	A mm	B mm	C mm	Area mm ²	Standard density kg/m ³	Return Time s	Weight kg
SL-030-12-D-MP1	3.1	6.5	50.0	50.0	12.5	2,500	200	4	0.006
SL-030-12-D-MP2	8.0	6.5	70.7	70.7	12.5	5,000	200	4	0.013
SL-030-12-D-MP3	19.0	6.5	100.0	100.0	12.5	10,000	200	4	0.025

¹ Maximum energy absorption in terms of area graded pad sizes as a reference for the correct selection of material and pad size. The energy absorption depends on the individual impact surface and stroke utilization.

SL-030-25

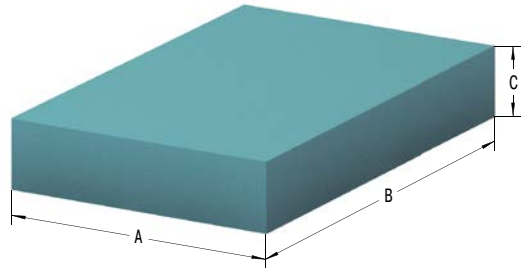

Characteristics

Type SL-030-25

Force-Stroke Characteristic (dynamic)

Stroke Utilization 12.5 mm

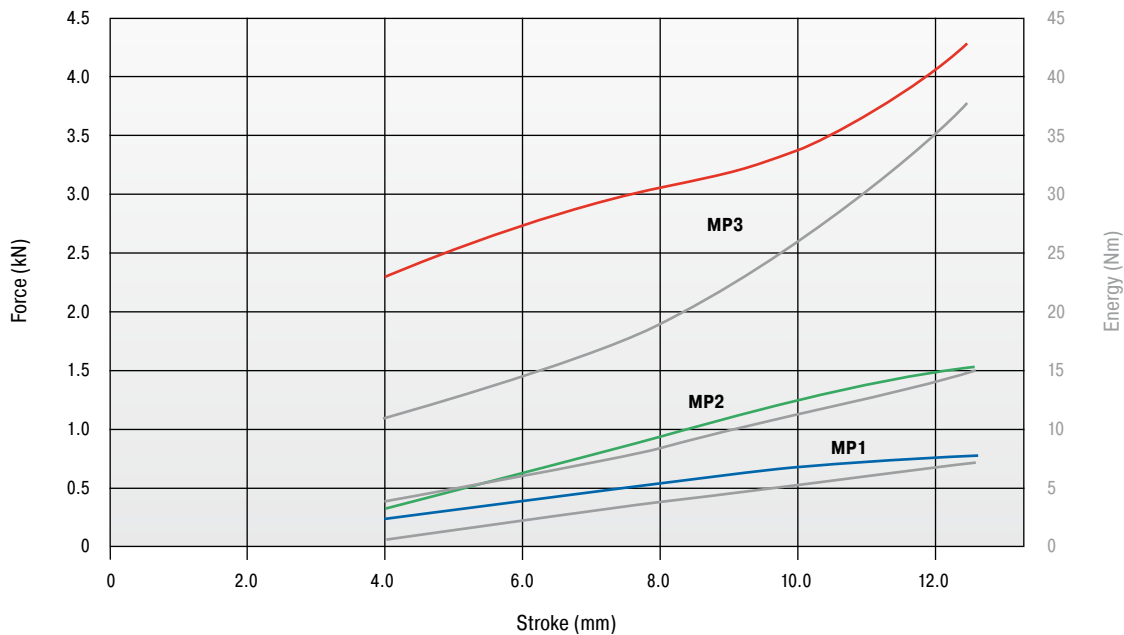

Load data

Dynamic load, impact velocity: approx. 1 m/s



The chosen damping plate should be tested by the customer on the specific application.

Ordering Example

ACE-SLAB _____ **SL-030-25-Dxxxx**
 Material Type _____
 Material Thickness 25 mm _____
 Customers Specific Dimension/Shape _____
 (D-Number is assigned by ACE)

Performance and Dimensions

TYPES	¹ W ₃ max. Nm/cycle	¹ Stroke mm	A mm	B mm	C mm	Area mm ²	Standard density kg/m ³	Return Time s	Weight kg
SL-030-25-D-MP1	6.7	12.5	50.0	50.0	25.0	2,500	200	5	0.013
SL-030-25-D-MP2	15.0	12.5	70.7	70.7	25.0	5,000	200	5	0.025
SL-030-25-D-MP3	42.0	12.5	100.0	100.0	25.0	10,000	200	5	0.050

¹ Maximum energy absorption in terms of area graded pad sizes as a reference for the correct selection of material and pad size. The energy absorption depends on the individual impact surface and stroke utilization.

SL-100-12

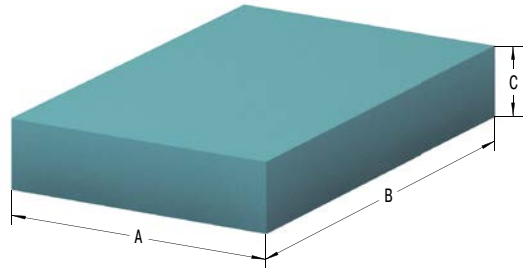

Characteristics

Type SL-100-12

Force-Stroke Characteristic (dynamic)

Stroke Utilization 6.5 mm

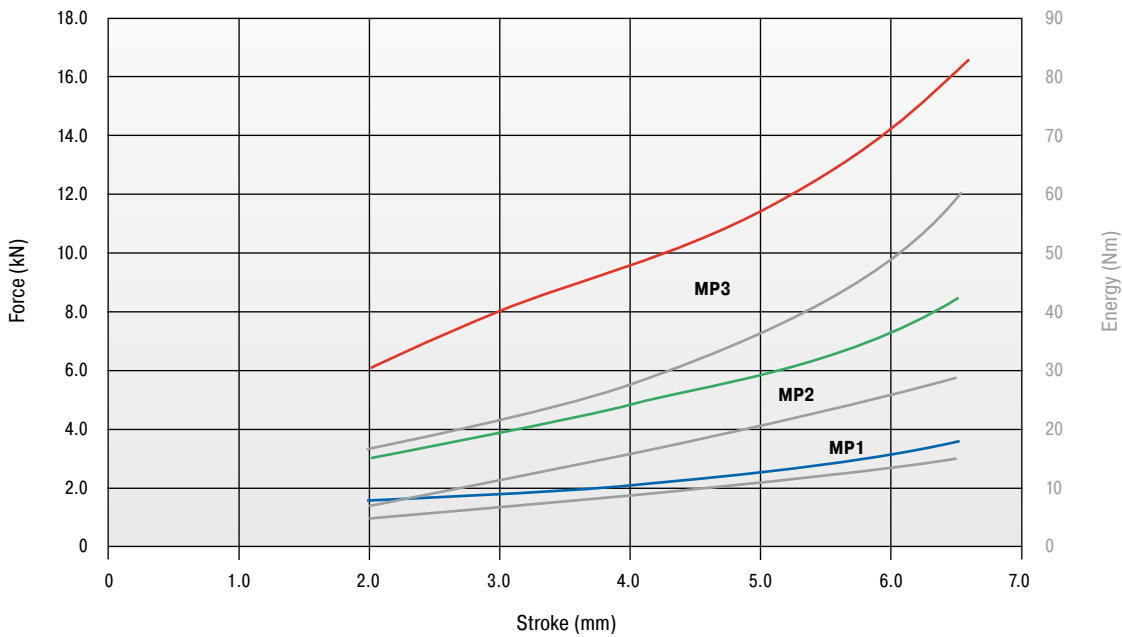

Load data

Dynamic load, impact velocity: approx. 1 m/s



The chosen damping plate should be tested by the customer on the specific application.

Ordering Example

ACE-SLAB _____ **SL-100-12-Dxxxx**
 Material Type _____
 Material Thickness 12.5 mm _____
 Customers Specific Dimension/Shape _____
 (D-Number is assigned by ACE)

Performance and Dimensions

TYPES	¹ W ₃ max. Nm/cycle	¹ Stroke mm	A mm	B mm	C mm	Area mm ²	Standard density kg/m ³	Return Time s	Weight kg
SL-100-12-D-MP1	15.0	6.5	50.0	50.0	12.5	2,500	440	4	0.014
SL-100-12-D-MP2	30.0	6.5	70.7	70.7	12.5	5,000	440	4	0.028
SL-100-12-D-MP3	60.0	6.5	100.0	100.0	12.5	10,000	440	4	0.055

¹ Maximum energy absorption in terms of area graded pad sizes as a reference for the correct selection of material and pad size. The energy absorption depends on the individual impact surface and stroke utilization.

SL-100-25

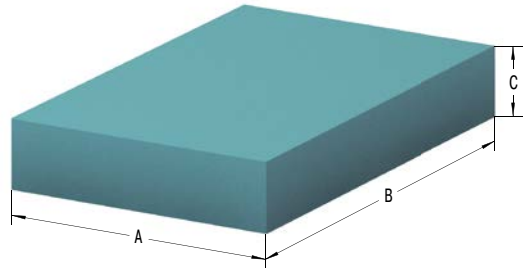

Characteristics

Type SL-100-25

Force-Stroke Characteristic (dynamic)

Stroke Utilization 12.5 mm

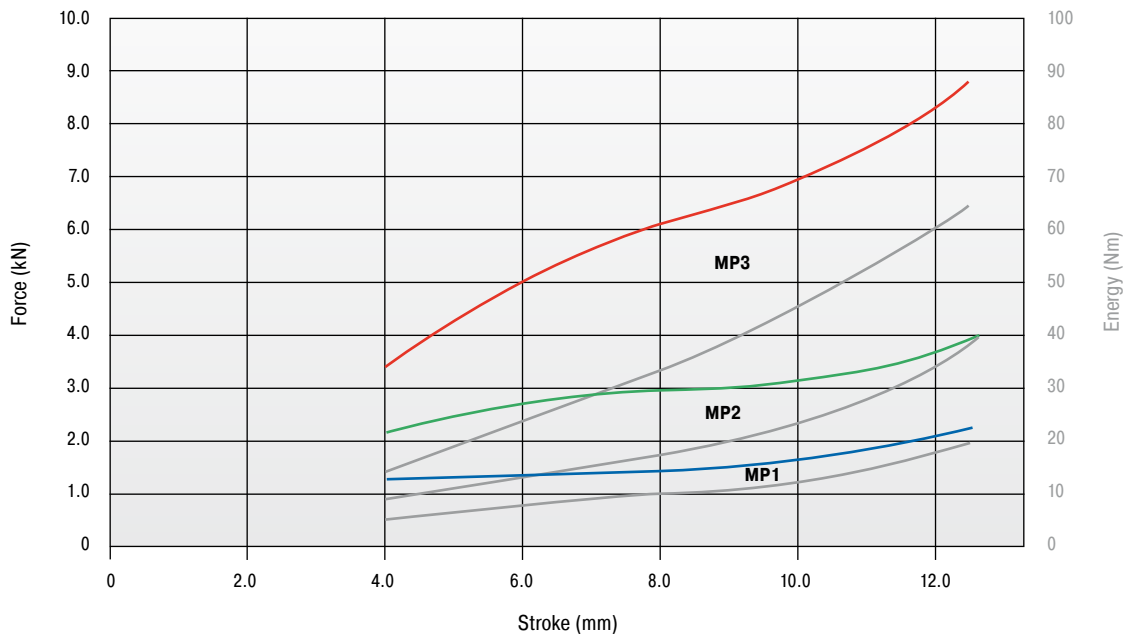

Load data

Dynamic load, impact velocity: approx. 1 m/s

— (Red line)	Area 10,000 mm ²
— (Green line)	Area 5,000 mm ²
— (Blue line)	Area 2,500 mm ²

The chosen damping plate should be tested by the customer on the specific application.

Ordering Example

ACE-SLAB _____ **SL-100-25-Dxxxx**
 Material Type _____
 Material Thickness 25 mm _____
 Customers Specific Dimension/Shape _____
 (D-Number is assigned by ACE)

Performance and Dimensions

TYPES	¹ W ₃ max. Nm/cycle	¹ Stroke mm	A mm	B mm	C mm	Area mm ²	Standard density kg/m ³	Return Time s	Weight kg
SL-100-25-D-MP1	20.0	12.5	50.0	50.0	25.0	2,500	440	5	0.028
SL-100-25-D-MP2	40.0	12.5	70.7	70.7	25.0	5,000	440	5	0.055
SL-100-25-D-MP3	63.0	12.5	100.0	100.0	25.0	10,000	440	5	0.110

¹ Maximum energy absorption in terms of area graded pad sizes as a reference for the correct selection of material and pad size. The energy absorption depends on the individual impact surface and stroke utilization.

SL-300-12

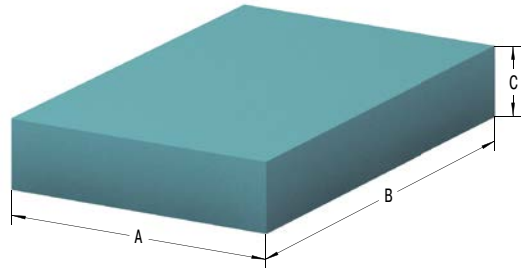

Characteristics

Type SL-300-12

Force-Stroke Characteristic (dynamic)

Stroke Utilization 6.5 mm

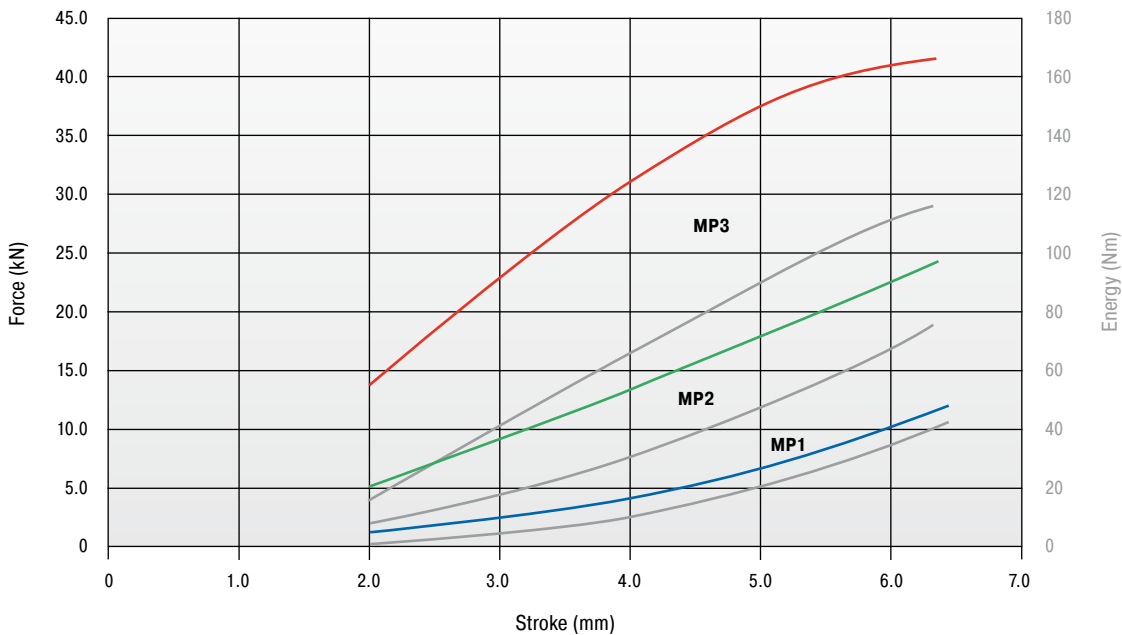

Load data

Dynamic load, impact velocity: approx. 1 m/s



The chosen damping plate should be tested by the customer on the specific application.

Ordering Example

SL-300-12-Dxxxx
 ACE-SLAB _____
 Material Type _____
 Material Thickness 12.5 mm _____
 Customers Specific Dimension/Shape _____
 (D-Number is assigned by ACE)

Performance and Dimensions

TYPES	¹ W ₃ max. Nm/cycle	¹ Stroke mm	A mm	B mm	C mm	Area mm ²	Standard density kg/m ³	Return Time s	Weight kg
SL-300-12-D-MP1	38.0	6.5	50.0	50.0	12.5	2,500	680	3	0.021
SL-300-12-D-MP2	65.0	6.5	70.7	70.7	12.5	5,000	680	3	0.043
SL-300-12-D-MP3	121.0	6.5	100.0	100.0	12.5	10,000	680	3	0.085

¹ Maximum energy absorption in terms of area graded pad sizes as a reference for the correct selection of material and pad size. The energy absorption depends on the individual impact surface and stroke utilization.

Confectioning and Combinable

SL-300-25

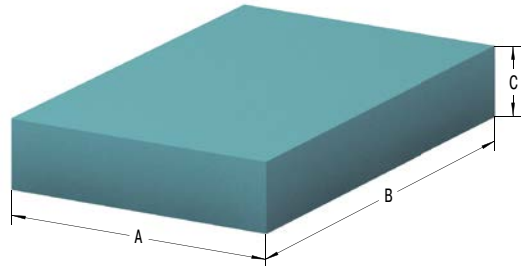

Characteristics

Type SL-300-25

Force-Stroke Characteristic (dynamic)

Stroke Utilization 12.5 mm

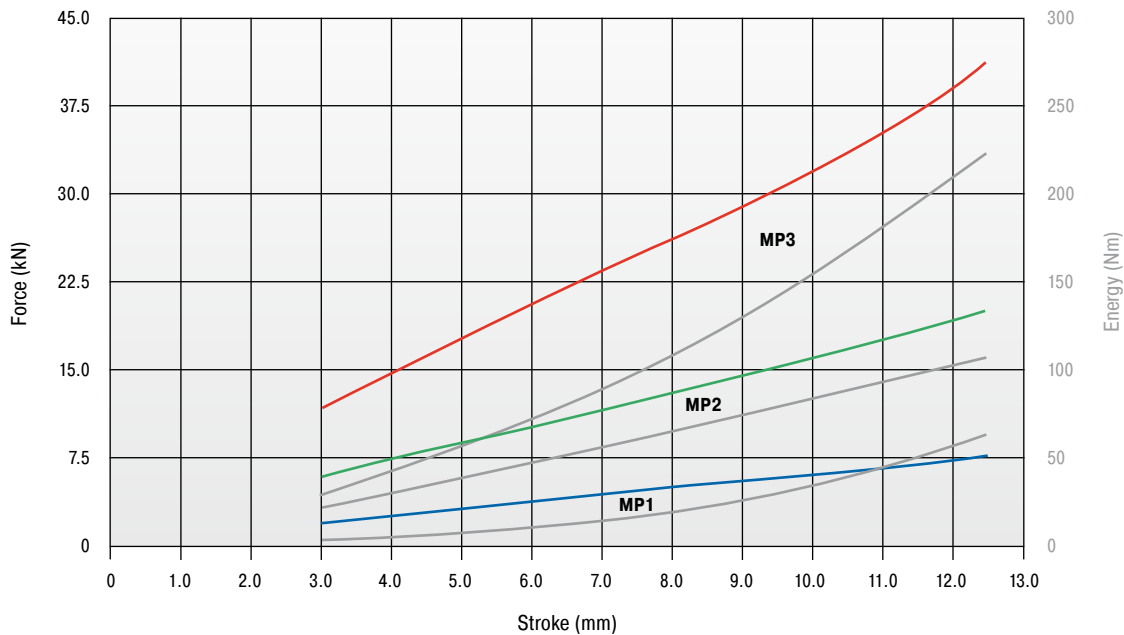

Load data

Dynamic load, impact velocity: approx. 1 m/s

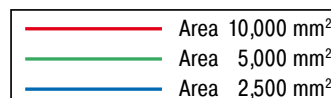

The chosen damping plate should be tested by the customer on the specific application.

Ordering Example

ACE-SLAB _____ **SL-300-25-Dxxxx**
 Material Type _____
 Material Thickness 25 mm _____
 Customers Specific Dimension/Shape _____
 (D-Number is assigned by ACE)

Performance and Dimensions

TYPES	¹ W ₃ max. Nm/cycle	¹ Stroke mm	A mm	B mm	C mm	Area mm ²	Standard density kg/m ³	Return Time s	Weight kg
SL-300-25-D-MP1	59.0	12.5	50.0	50.0	25.0	2,500	680	4	0.043
SL-300-25-D-MP2	101.0	12.5	70.7	70.7	25.0	5,000	680	4	0.085
SL-300-25-D-MP3	210.0	12.5	100.0	100.0	25.0	10,000	680	4	0.170

¹ Maximum energy absorption in terms of area graded pad sizes as a reference for the correct selection of material and pad size. The energy absorption depends on the individual impact surface and stroke utilization.

Bonding of Polyurethane (PUR) Elastomers

Cellular and compact parts of polyurethane (PUR) elastomers SLAB damping pads can be bonded according to the following recommendations. If treatment instructions are followed, the strengths of the bonded joint can be equivalent to the elastomer material itself.

1. General Information

To achieve the required bonding strength it is necessary to ensure the correct adhesive is chosen for each individual application.

Contact bonding material

Thin adhesive film, with little filling of the gaps. Correcting or moving of the areas covered with bonding material is no longer possible after the first contact is made (contact effect).

Once a bonding is separated, the bonding process must be renewed.

Please note that creases, ripples or blisters cannot be straightened once the contact is made.

Hardening bonding material

(As thin as possible) the film of glue fills the joint. The gluing can be done after the edges are brought together.

2. Preparation

The preparation of bonding surfaces is of significant importance for the bonding strength. The surfaces must be adapted to each other and available in plain, clean form.

Careful removal of

Adhesive remnants, oil, fat, separating agents, dirt, dust, scales, molding layers, protective coating, finish, paint, sweat etc.

Mechanical support

Stripping, brushing, scraping, grinding, sandblasting.

Chemical support

Degreasing (washing off with grease remover), etching, priming; pay attention to chemical resistancy on the following page!

In general, SLAB damping pads in sheet form can be bonded without pretreatment. Molded parts, with or without special skin, have to be cleaned from left-over separating agents, if necessary by grinding. When bonding with other materials like plastic, wood, metal or concrete, mechanical and/or chemical additives have to be used.

The adhesive has to be prepared according to the formula, observing the manufacturer's recommendations. The adhesive film is also to be carefully applied pursuant to these details. (Tools: brush, spatula, adhesive spreader, airless spray gun).

Contact bonding material

Apply the non-gap-filling adhesive film to both bonding surfaces – the thinner, the better. To close the pores of low density materials, two layers may be necessary.

Hardening bonding material

Apply evenly. Possible irregularities can be compensated by the film thickness.

3. Bonding

When using contact bonding material, the flash off time has to be kept in mind. Especially, with systems containing water instead of usual solvents, the adhesive film must be as dry as possible in order to pass the 'finger test' – no marks appear when touching the adhesive surface. When using hardening bonding material, the parts have to be joined immediately after applying the bonding material.

4. Pressing

Contact bonding material Contact pressure up to 0.5 N/mm²
Hardening bonding material Fix firmly

It is important to carefully follow the manufacturer's instructions with regard to processing temperature, hardening time and earliest possible loading.

5. Selection of Approved Bonding Materials

Because of the variety of materials that can be bonded together as well as numerous suitable bonding materials, we refer you to a worldwide leading producer of bonding and sealing materials.

Sika Deutschland GmbH
 Kornwestheimer Straße 103-107
 D-70439 Stuttgart
 T +49 (0)711 - 8009-0
 F +49 (0)711 - 8009-321
 info@de.sika.com
 http://www.sika.de

Chemical Resistance

Test (following DIN 53428)

Exposure time of the medium: 6 weeks at room temperature, but for concentrated acids and bases as well as solvents: 7 days at room temperature

Evaluation Criteria

Changing of tensile strength and elongation of break (dry samples), change in volume

Evaluation Standard

1 Excellent resistance	change in characteristics <10 %
2 Good resistance	change in characteristics between 10 % and 20 %
3 Conditional resistance	change in characteristics partly above 20 %
4 Not resistant	change in characteristics all above 20 %

All information is based on our current knowledge and experiences. We reserve the rights for changes towards product refinement.

Chemical Resistance

Water/Watery Solutions	SL-030 to SL-300
Water	1
Iron (III) chloride 10 %	1
Sodium carbonate	1
Sodium chlorate 10 %	1
Sodium chloride 10 %	1
Sodium nitrate 10 %	1
Tensides (div.)	1
Hydrogen peroxide 3 %	1
Laitance	1

Oils and Greases

ASTM Oil No. 1	1
ASTM Oil No. 3	1
Laitance	2
Hydraulic oils	depends on consistency/additives
Motor oil	1
Formwork oil	1
High performance grease	1-2
Railroad switch lubricant	1-2

Acids and Bases

Formic acid 5 %	3
Acetic acid 5 %	2
Phosphoric acid 5 %	1
Nitic acid 5 %	4
Hydrochloric acid 5 %	1
Sulphuric acid 5 %	1
Ammonia solution 5 %	1
Caustic potash solution 5 %	1
Caustic soda solution 5 %	1

Solvents	SL-030 to SL-300
Acetone	4
Diesel/Fuel oil	2
Carburetor fuel/Benzine	3
Glycerin	1
Glycols	1-2
Cleaning solvents/Hexane	1
Methanol	3
Aromatic hydrocarbons	4

Other Factors

Hydrolysis *	1
Ozone	1
UV radiation and weathering	1-2
Biological resistance	1

* 28 days, 70 °C, 95 % relative humidity

Sample Pads and Sample Sets

Sample Pads

Part Number	Dimensions and Type
SL-030-12-D-MP4	220 x 150 x 12.5 mm
SL-030-12-D-MP4-V+K	220 x 150 x 12.5 mm + layer for wear protection 2 mm, self-adhesive on one side
SL-030-25-D-MP4	220 x 150 x 25 mm
SL-100-12-D-MP4	220 x 150 x 12.5 mm
SL-100-12-D-MP4-V+K	220 x 150 x 12.5 mm + layer for wear protection 2 mm, self-adhesive on one side
SL-100-25-D-MP4	220 x 150 x 25 mm
SL-300-12-D-MP4	220 x 150 x 12.5 mm
SL-300-12-D-MP4-V+K	220 x 150 x 12.5 mm + layer for wear protection 2 mm, self-adhesive on one side
SL-300-25-D-MP4	220 x 150 x 25 mm
SL-030-12-D-MP5	1500 x 800 x 12 mm
SL-030-25-D-MP5	1500 x 800 x 25 mm
SL-100-12-D-MP5	1500 x 800 x 12 mm
SL-100-25-D-MP5	1500 x 800 x 25 mm
SL-300-12-D-MP5	1500 x 800 x 12 mm
SL-300-25-D-MP5	1500 x 800 x 25 mm

Sample Sets

Individually arranged sample sets are available on request!
 3 densities. Dimensions: 50 x 50 mm, 70.7 x 70.7 mm and 100 x 100 mm. Thickness: 12.5 and 25 mm

Set "Sizes"

comprising 1 model, 1 type of thickness, 3 sizes = 3 sample pads

Part Number	Content	Dimensions
SL-SET-1.1	SL-030-12-MP1 to MP3	50 x 50 mm / 70.7 x 70.7 mm / 100 x 100 mm
SL-SET-1.2	SL-030-25-MP1 to MP3	50 x 50 mm / 70.7 x 70.7 mm / 100 x 100 mm
SL-SET-1.3	SL-100-12-MP1 to MP3	50 x 50 mm / 70.7 x 70.7 mm / 100 x 100 mm
SL-SET-1.4	SL-100-25-MP1 to MP3	50 x 50 mm / 70.7 x 70.7 mm / 100 x 100 mm
SL-SET-1.5	SL-300-12-MP1 to MP3	50 x 50 mm / 70.7 x 70.7 mm / 100 x 100 mm
SL-SET-1.6	SL-300-25-MP1 to MP3	50 x 50 mm / 70.7 x 70.7 mm / 100 x 100 mm

Set "Types"

comprising 3 models, 1 type of thickness, 1 size = 3 sample plates

Part Number	Content	Dimensions
SL-SET-2.1	SL-030-12-D-MP1, SL-100-12-D-MP1, SL-300-12-D-MP1	50 x 50 mm
SL-SET-2.2	SL-030-25-D-MP1, SL-100-25-D-MP1, SL-300-25-D-MP1	50 x 50 mm
SL-SET-2.3	SL-030-12-D-MP2, SL-100-12-D-MP2, SL-300-12-D-MP2	70.7 x 70.7 mm
SL-SET-2.4	SL-030-25-D-MP2, SL-100-25-D-MP2, SL-300-25-D-MP2	70.7 x 70.7 mm
SL-SET-2.5	SL-030-12-D-MP3, SL-100-12-D-MP3, SL-300-12-D-MP3	100 x 100 mm
SL-SET-2.6	SL-030-25-D-MP3, SL-100-25-D-MP3, SL-300-25-D-MP3	100 x 100 mm

Application Examples

SL-030, TA

Damping combination SLAB and TUBUS

SLAB-TUBUS-Combination ensures fast luggage transport. Airports endeavour to shorten air passengers' waiting times as much as possible. This aim is met with a solution especially developed for luggage transport systems and has solved previous damping issue. Transport carriers with a weight of up to 120 kg can now be moved at the desired conveyor belt speeds. A SLAB-combination of the material SL-030-12(25)-Dxxxx together with two TA40-16 type TUBUS profile dampers are used here.



Fast luggage transport for airport customers

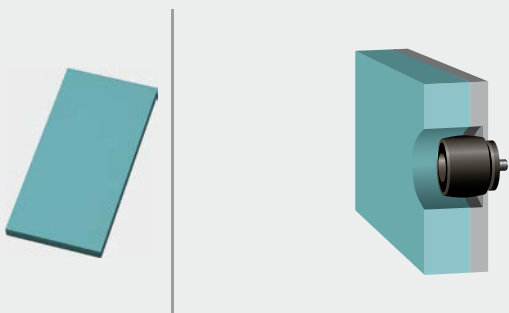

SL-030

Noise reduction

ACE-SLAB damping pads protect man and machine. At the beginning of the construction phase of a modern processing centre at the end position, a 25 kg cable channel collided with force against the housing and produced a deafening noise and mechanical strain on the energy chain. A reliable solution for compliance with the operational parameters was realized with the SL-030-25-Dxxxx type ACE-SLAB damping pads even before the milling machine was finished.



Low-noise energy chain

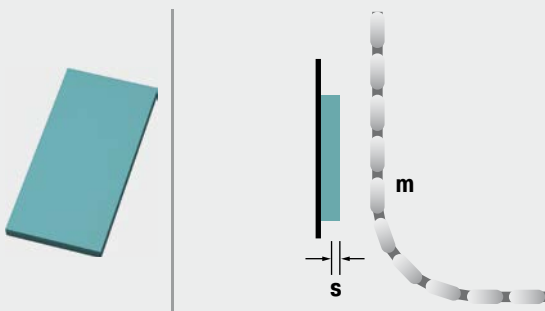

SL-030

Impact reduction in ring form

ACE-SLAB damping pads make tyre transport safer. Developed for absorbing the impact of forces, the ACE-SLAB damping pads SL-030-121-Dxxxx applied in this tyre testing system are ideal for protecting the sliding parts of the machine during quality tests. The individual customisation of the ring form of the centre arm and simple integration into the equipment also support the decision for applying these innovative absorber elements.

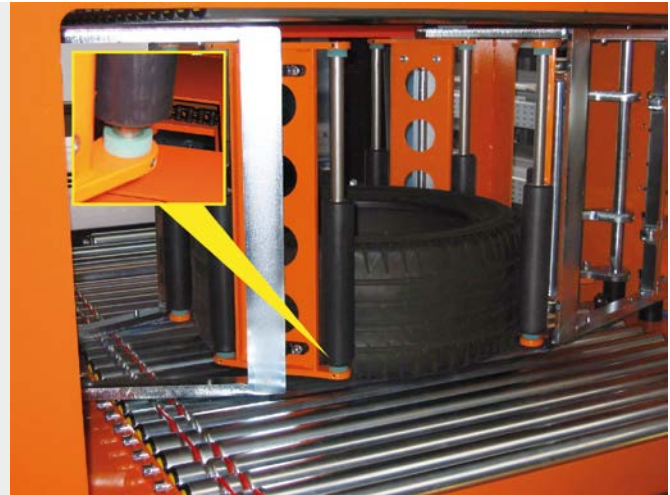

Perfectly fitted machine protection
SDS Systemtechnik GmbH, 75365 Calw, Germany

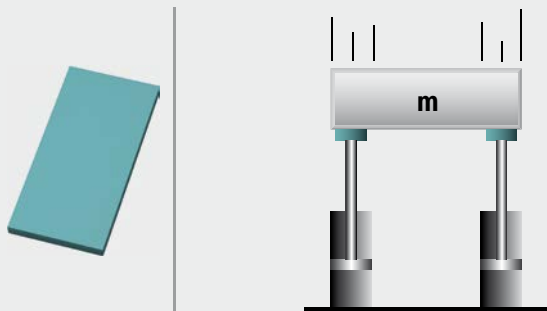

SL-030

Impact protection for large areas

ACE-SLAB damping pads offer impact protection for wooden battens. To protect wooden battens with differing weights and impact speeds of approx. 2 m/s, the SLAB-material SL-030-12-Dxxxx was screwed across the whole surface between two steel sheets in this application. This creates an even damping effect over the whole impact area, which protects the impact surfaces of the battens from an excessive impact load. The minimisation of recoil as well as reduction of noise are further positive side effects of this construction.



Impact protection for wooden battens

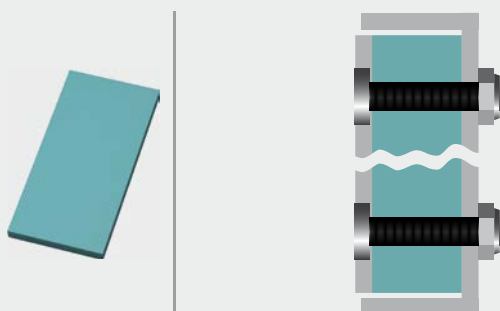

Motion Control

Gas Springs – Push Type, Gas Springs – Pull Type
Hydraulic Dampers, Hydraulic Feed Controls
Rotary Dampers



Perfect Support for Muscle Power

Customised to suit your applications

The various products from ACE in this segment give a new quality to any type of movement. Anyone who wants to raise or lower loads, regulate the feed of an object to the precise millimetre or gently decelerate rotating or linear movements will find the right helper here.

ACE also convinces with industry quality in this area. And the innovative solutions also correspond with the maximum requirements of ergonomics and individuality, including with customised, fillable gas springs.



Industrial Gas Springs – Push Type

Lifting and lowering for smart people

Anyone who wants to lift or lower loads with control and without excessive strength relies on the industrial gas push type springs from ACE. These maintenance-free, ready-to-install machine elements, which are available from stock, support sheer muscle power and reliably open and hold.

Available with body diameters of 8 mm to 70 mm and forces from 10 N to 13,000 N, ACE gas push type springs are characterised by a huge variety and maximum service life. The first is achieved thanks to the number of available connections and fittings for simple attachment and the latter with high quality design and materials. Whether they are made of steel or stainless steel, these components make any work easier and also make a particularly good impression visually in every branch.

Ready-to-install and universally applicable

Modular end fittings and mounting brackets

Calculation program for individual design

No own construction costs

Maintenance-free

Available with valve ex stock



Function of a Gas Spring – Push Type

ACE gas springs are individually filled to a predetermined pressure to suit a customer's requirement (extension Force F_1). The cross-sectional area of the piston rod and filling pressure determines the extension force.

During the compression of the piston rod, nitrogen flows through an orifice in the piston from the full bore side of the piston to the annulus. The nitrogen is compressed by the volume of the piston rod. As the piston rod is compressed the pressure increases, so increasing the reaction force (progression). The force depends on the proportional relationship between the piston rod and the inner tube diameter, which is approximately linear.

Calculation Principles

Force-Stroke Characteristics of Gas Spring (Push Type)

Free calculation service see page 172!

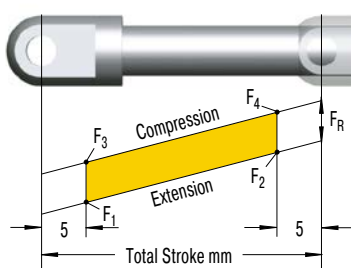

F_1 = nominal force at 20 °C (this is the pressure figure normally used when specifying the gas spring)

F_2 = force in the complete compressed position

When compressing the piston rod, there is an additional friction force caused by the contact pressure of the seals (this **only** occurs **during the compression stroke**):

F_3 = force at the beginning of the compression stroke

F_4 = force at the end of the compression stroke

Gas Springs (Push Type)

TYPES	Progression approx. %	¹ Friction F_R approx. in N
GS-8	29 - 33 ²	10
GS-10	13 - 16 ²	10
GS-12	20 - 35 ²	20
GS-15	30 - 40 ²	20
GS-19	24 - 35 ²	30
GS-22	30 - 40 ²	30
GS-28	63 - 76 ²	40
GS-40	38 - 50 ²	50
GS-70	25	50

¹ Depending on the filling force

² Depending on the stroke

Progression: (the slope of the force line in the diagram above) is due to the reduction of the internal gas volume as the piston rod moves from its initial position to its fully stroked position. The approx. progression values given above for standard springs can be altered on request.

Effect of temperature: The nominal F_1 figure is given at 20 °C. An increase of 10 °C will increase force by 3.4 %.

Filling tolerances: -20 N to +40 N or 5 % to 7 %. Depending on size and extension force the tolerances can differ.

Industrial Gas Springs – Push Type



GS-8 to GS-70

Valve Technology

Individual stroke length and extension forces

Hoods, Shutters, Machine housing, Conveyor systems

Page 134



GS-8-V4A to GS-40-VA

Valve Technology, Stainless Steel

With food grade oil according to FDA approval

Hoods, Shutters, Machine housing, Conveyor systems

Page 144



GST-40 Tandem

Valve Technology

Optimised dual force for heavy flaps and wide angle applications

Hoods, Shutters, Machine housing, Conveyor systems

Page 154

GS-8 to GS-70

Individual stroke length and extension forces

Valve Technology

Force range 10 N to 13,000 N

Stroke 20 mm to 1,000 mm

Universal and tailor made: ACE industrial gas push type springs of the NEWTONLINE family offer perfect support of muscle power with forces from 10 to 13,000 N with body diameter of 8 to 70 mm. With their high quality features the NEWTONLINE gas springs form the industry standard. These durable and sealed systems are ready for installation, maintenance-free and filled with pressurised nitrogen gas.

They are supplied filled according to individual customer pressure requirements and maybe adjusted later by use of the inbuilt valve. The free of charge ACE calculation service designs the gas springs with mounting points specifically for the particular application. A variety of additional components makes assembly even easier and allows universal application of the gas springs.

ACE industrial gas push type springs are used in industrial applications, mechanical engineering and medical technology as well as in the electronics, automobile and furniture industries.

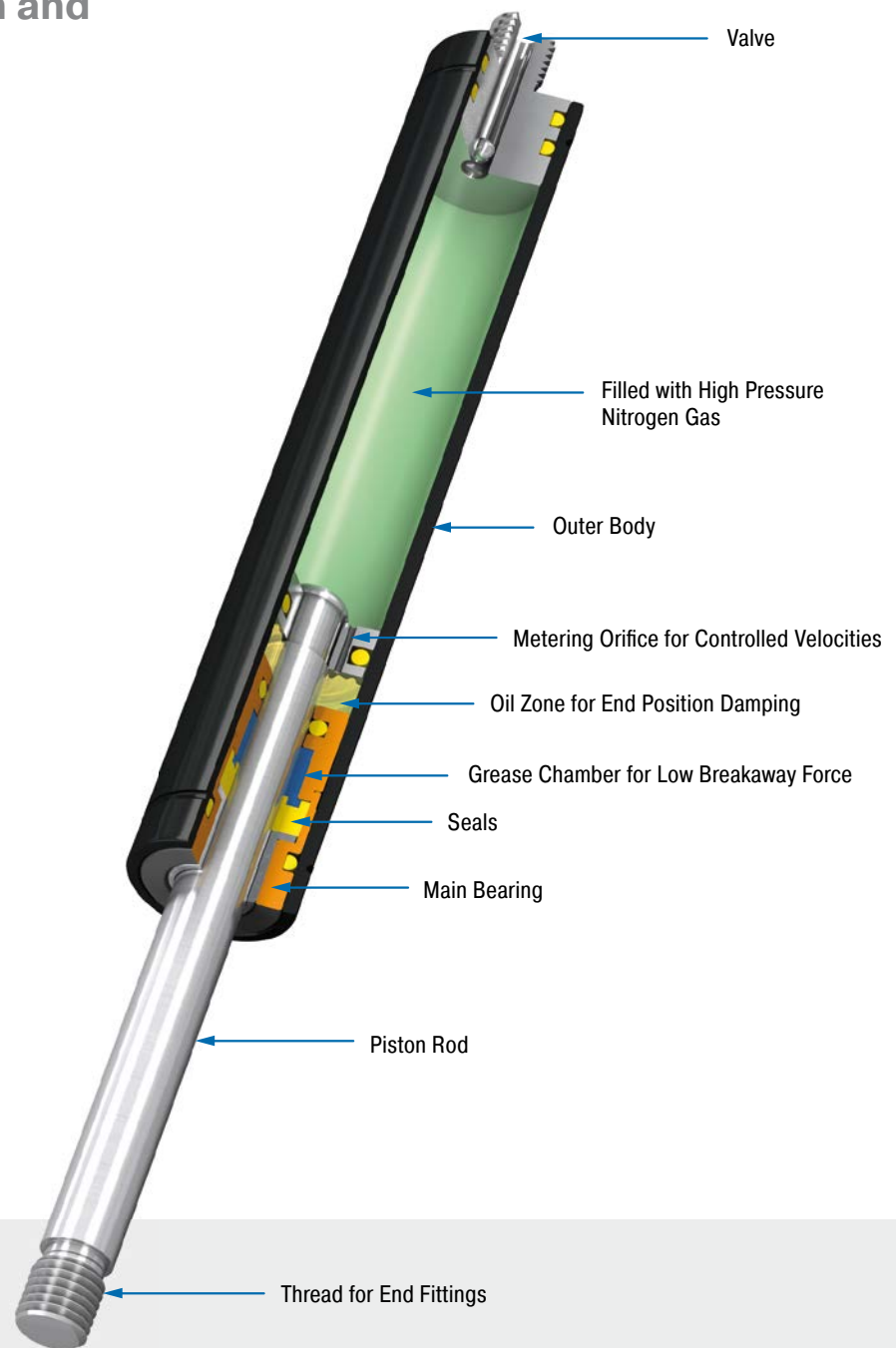

Technical Data

Extension force: 10 N to 13,000 N

Piston rod diameter: Ø 3 mm to Ø 30 mm

Progression: approx. 13 % to 76 % (depending on size and stroke)

Lifetime: Approx. 10,000 m

Operating temperature range: -20 °C to +80 °C

Material: Outer body: coated steel; Piston rod: steel or stainless steel with wear-resistant coating; End fittings: zinc plated steel

Operating fluid: nitrogen gas and oil

Mounting: We recommend mounting with piston rod downwards to take advantage of the built-in end position damping.

End position damping length: Approx. 5 mm to 70 mm (depending on the stroke)

Positive stop: External positive stop at the end of stroke provided by the customer.

Application field: hoods, shutters, machine housing, conveyor systems, control boxes, furniture industry, jacking applications, assembly stations, vehicle technology, folding elements

Note: Increased break-away force if unit has not moved for some time.

End fittings: They are interchangeable and if necessary must be positively secured by the customer to prevent unscrewing.

Safety instructions: Gas springs (push type) should not be installed under pre-tension.

On request: Special oils and other special options. Alternative accessories. Different end position damping and extension speed.

Valve Technology, Extension force 10 N to 100 N (compressed up to 133 N)

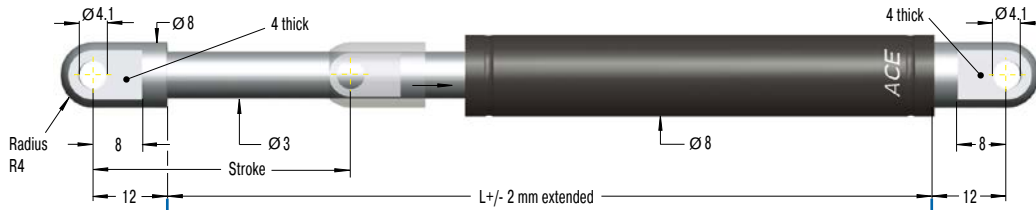
End Fitting
Standard Dimensions
End Fitting
A3,5

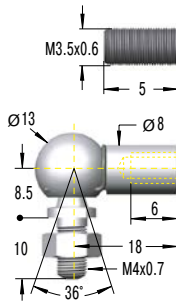
Eye A3,5
max. force 370 N

B3,5
C3,5

Performance and Dimensions

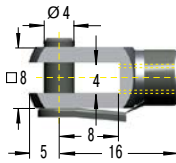
TYPES	Stroke mm	L extended mm	Extension force max. N
GS-8-20	20	72	100
GS-8-30	30	92	100
GS-8-40	40	112	100
GS-8-50	50	132	100
GS-8-60	60	152	100
GS-8-80	80	192	100

Stud Thread B3,5
Angle Ball Joint C3,5
max. force 370 N

D3,5

Ordering Example
GS-8-30-AC-30

Type (Push Type) _____
 Body Ø (8 mm) _____
 Stroke (30 mm) _____
 Piston Rod End Fitting A3,5 _____
 Body End Fitting C3,5 _____
 Nominal Force F₁ 30 N _____

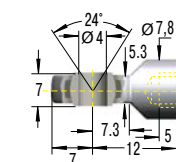
Clevis Fork D3,5
max. force 370 N

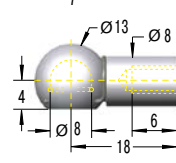
E3,5

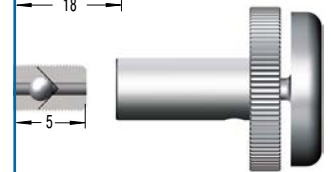
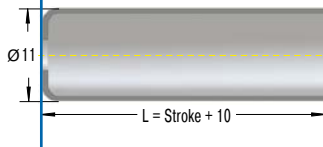
Swivel Eye E3,5
max. force 370 N

G3,5

Ball Socket G3,5
max. force 370 N

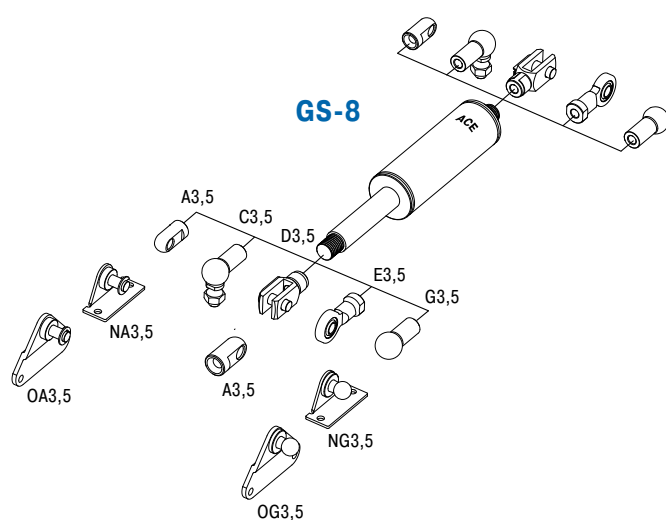
Rod Shroud W3,5-8

**Adjuster Knob
DE-GAS-3,5**
See page 175.

Mounting accessories see from page 200.

Technical Data
Extension force: 10 N to 100 N (compressed up to 133 N)

Progression: Approx. 29 % to 33 %

Operating temperature range: -20 °C to +80 °C

Material: Outer body: coated steel; Piston rod: stainless steel (1.4301/1.4305, AISI 304/303); End fittings: zinc plated steel

Mounting: We recommend mounting with piston rod downwards to take advantage of the built-in end position damping.

End position damping length: approx. 5 mm (depending on the stroke)

Positive stop: External positive stop at the end of stroke provided by the customer.

Note: Increased break-away force if unit has not moved for some time.

End fittings: They are interchangeable and if necessary must be positively secured by the customer to prevent unscrewing.

Safety instructions: Gas springs (push type) should not be installed under pre-tension.

Valve Technology, Extension force 10 N to 100 N (compressed up to 116 N)

End Fitting

Standard Dimensions

End Fitting

A3,5

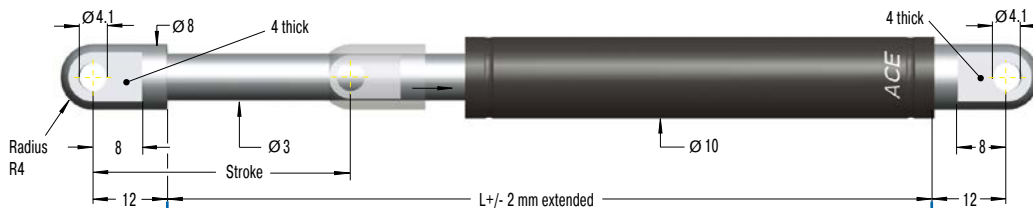

Eye A3,5
max. force 370 N

B3,5



Performance and Dimensions

TYPES	Stroke mm	L extended mm	Extension force max. N
GS-10-20	20	72	100
GS-10-30	30	92	100
GS-10-40	40	112	100
GS-10-50	50	132	100
GS-10-60	60	152	100
GS-10-80	80	192	100

Stud Thread B3,5

C3,5

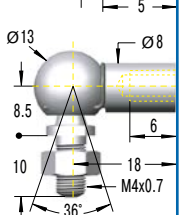

Angle Ball Joint C3,5
max. force 370 N

D3,5

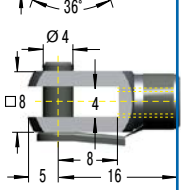

Clevis Fork D3,5
max. force 370 N

E3,5

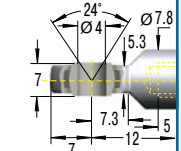

Swivel Eye E3,5
max. force 370 N

G3,5

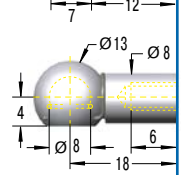

Ball Socket G3,5
max. force 370 N

Rod Shroud W3,5-10

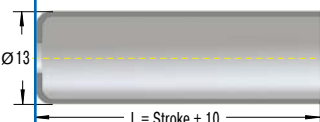

Ordering Example

GS-10-80-AC-60
 Type (Push Type) _____
 Body Ø (10 mm) _____
 Stroke (80 mm) _____
 Piston Rod End Fitting A3,5 _____
 Body End Fitting C3,5 _____
 Nominal Force F₁ 60 N _____

Mounting accessories see from page 200.

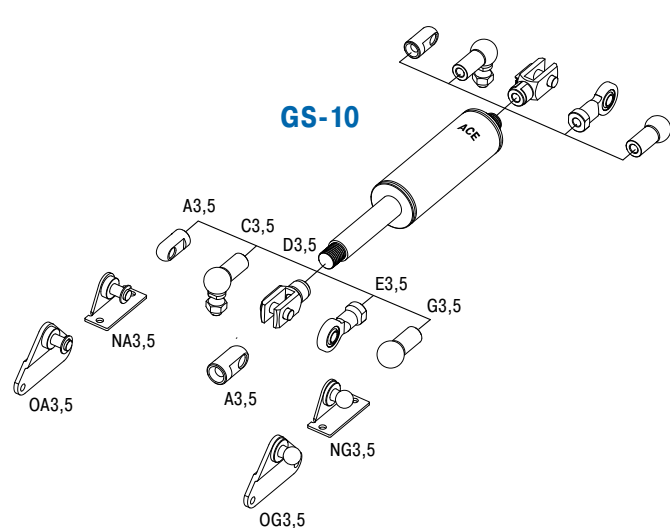

Technical Data

- Extension force:** 10 N to 100 N (compressed up to 116 N)
- Progression:** Approx. 13 % to 16 %
- Operating temperature range:** -20 °C to +80 °C
- Material:** Outer body: coated steel; Piston rod: stainless steel (1.4301/1.4305, AISI 304/303); End fittings: zinc plated steel
- Mounting:** We recommend mounting with piston rod downwards to take advantage of the built-in end position damping.
- End position damping length:** approx. 5 mm (depending on the stroke)
- Positive stop:** External positive stop at the end of stroke provided by the customer.
- Note:** Increased break-away force if unit has not moved for some time.
- End fittings:** They are interchangeable and if necessary must be positively secured by the customer to prevent unscrewing.
- Safety instructions:** Gas springs (push type) should not be installed under pre-tension.

Issue 07.2017 – Specifications subject to change

Valve Technology, Extension force 15 N to 180 N (compressed up to 243 N)

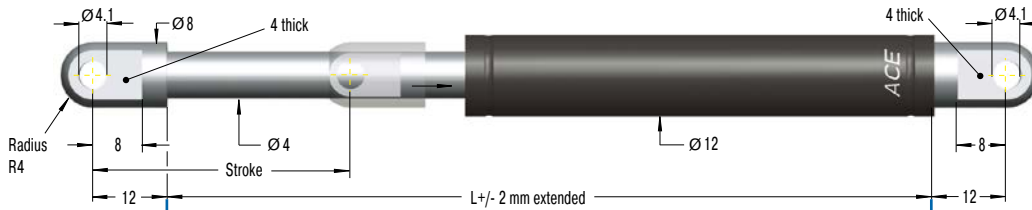
End Fitting
Standard Dimensions
End Fitting
A3,5

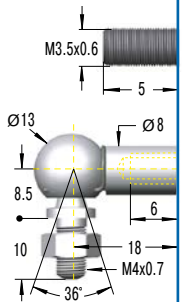
Eye A3,5
max. force 370 N

B3,5
C3,5

Performance and Dimensions

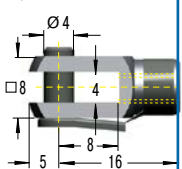
TYPES	Stroke mm	L extended mm	Extension force max. N
GS-12-20	20	72	180
GS-12-30	30	92	180
GS-12-40	40	112	180
GS-12-50	50	132	180
GS-12-60	60	152	180
GS-12-80	80	192	150
GS-12-100	100	232	150
GS-12-120	120	272	120
GS-12-150	150	332	100

Stud Thread B3,5
Angle Ball Joint C3,5
max. force 370 N

D3,5

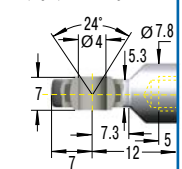
Ordering Example
GS-12-100-AA-30

Type (Push Type) _____
 Body Ø (12 mm) _____
 Stroke (100 mm) _____
 Piston Rod End Fitting A3,5 _____
 Body End Fitting A3,5 _____
 Nominal Force F₁ 30 N _____

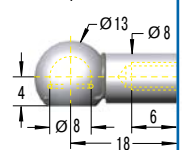
E3,5

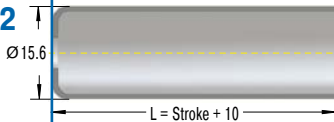
Clevis Fork D3,5
max. force 370 N

G3,5

Swivel Eye E3,5
max. force 370 N

Rod Shroud W3,5-12

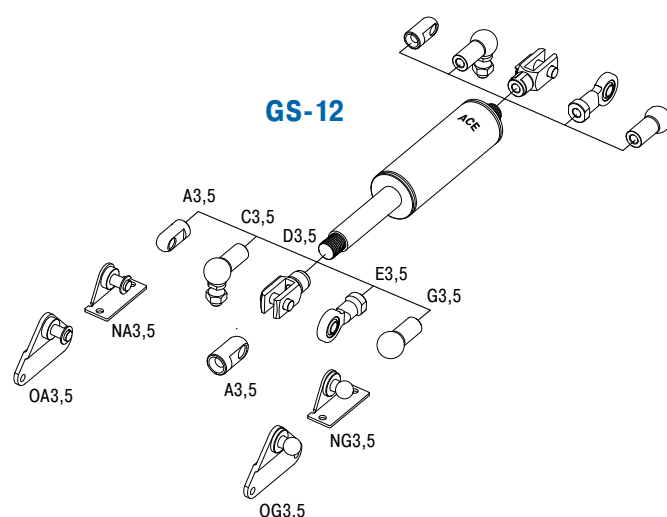
Ball Socket G3,5
max. force 370 N

Mounting accessories see from page 200.

Issue 07.2017 – Specifications subject to change

Technical Data
Extension force: 15 N to 180 N (compressed up to 243 N)

Progression: Approx. 20 % to 35 %

Operating temperature range: -20 °C to +80 °C

Material: Outer body: coated steel; Piston rod: stainless steel (1.4301/1.4305, AISI 304/303); End fittings: zinc plated steel

Mounting: We recommend mounting with piston rod downwards to take advantage of the built-in end position damping.

End position damping length: approx. 10 mm (depending on the stroke)

Positive stop: External positive stop at the end of stroke provided by the customer.

Note: Increased break-away force if unit has not moved for some time.

End fittings: They are interchangeable and if necessary must be positively secured by the customer to prevent unscrewing.

Safety instructions: Gas springs (push type) should not be installed under pre-tension.

Adjuster Knob DE-GAS-3,5
See page 175.

Valve Technology, Extension force 40 N to 400 N (compressed up to 560 N)

End Fitting

Standard Dimensions

End Fitting

Performance and Dimensions

TYPES	Stroke mm	L extended mm	Extension force max. N
GS-15-20	20	67	400
GS-15-40	40	107	400
GS-15-50	50	127	400
GS-15-60	60	147	400
GS-15-80	80	187	400
GS-15-100	100	227	400
GS-15-120	120	267	400
GS-15-150	150	327	400
GS-15-200	200	427	350

Ordering Example

GS-15-150-AC-150

Type (Push Type) _____
 Body Ø (15.6 mm) _____
 Stroke (150 mm) _____
 Piston Rod End Fitting A5 _____
 Body End Fitting C5 _____
 Nominal Force F₁ 150 N _____

Mounting accessories see from page 200.

Adjuster Knob DE-GAS-5
 See page 175.

Rod Shroud W5-15
 Ø 19
 L = Stroke + 20

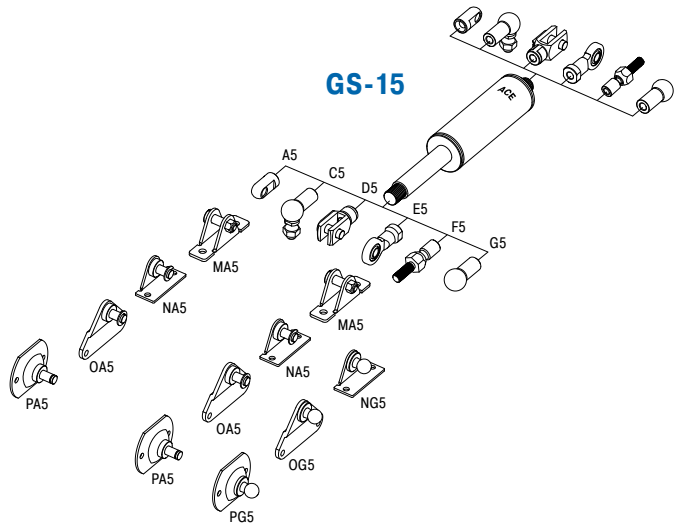

Technical Data

- Extension force:** 40 N to 400 N (compressed up to 560 N)
- Progression:** Approx. 30 % to 40 %
- Operating temperature range:** -20 °C to +80 °C
- Material:** Outer body: steel coated with UV paint; Piston rod: steel with wear-resistant coating; End fittings: zinc plated steel
- Mounting:** We recommend mounting with piston rod downwards to take advantage of the built-in end position damping.
- End position damping length:** approx. 10 mm (depending on the stroke)
- Positive stop:** External positive stop at the end of stroke provided by the customer.
- Note:** Increased break-away force if unit has not moved for some time.
- End fittings:** They are interchangeable and if necessary must be positively secured by the customer to prevent unscrewing.
- Safety instructions:** Gas springs (push type) should not be installed under pre-tension.

Issue 07.2017 – Specifications subject to change

Valve Technology, Extension force 50 N to 700 N (compressed up to 945 N)

End Fitting
Standard Dimensions
End Fitting

A8

B8

C8

D8

E8

F8

G8

Rod Shroud W8-19

Performance and Dimensions

TYPES	Stroke mm	L extended mm	Extension force max. N
GS-19-50	50	164	700
GS-19-100	100	264	700
GS-19-150	150	364	700
GS-19-200	200	464	700
GS-19-250	250	564	600
GS-19-300	300	664	450

Ordering Example

GS-19-150-AC-600

Type (Push Type) _____

Body Ø (19 mm) _____

Stroke (150 mm) _____

Piston Rod End Fitting A8 _____

Body End Fitting C8 _____

Nominal Force F₁ 600 N _____

Eye A8
max. force 3,000 N

Stud Thread B8

Angle Ball Joint C8
max. force 1,200 N

Clevis Fork D8
max. force 3,000 N

Swivel Eye E8
max. force 3,000 N

Inline Ball Joint F8
max. force 1,200 N

Ball Socket G8
max. force 1,200 N

Adjuster Knob DE-GAS-8
See page 175.

Mounting accessories see from page 200.

Technical Data
Extension force: 50 N to 700 N (compressed up to 945 N)

Progression: Approx. 24 % to 35 %

Operating temperature range: -20 °C to +80 °C

Material: Outer body: steel coated with UV paint; Piston rod: steel with wear-resistant coating; End fittings: zinc plated steel

Mounting: In any position. Hint: We recommend mounting with piston rod downwards to take advantage of the built-in end position damping.

End position damping length: approx. 20 mm to 60 mm (depending on the stroke)

Positive stop: External positive stop at the end of stroke provided by the customer.

Note: Integrated grease chamber reduces friction and wear and optimises lubrication.

End fittings: They are interchangeable and if necessary must be positively secured by the customer to prevent unscrewing.

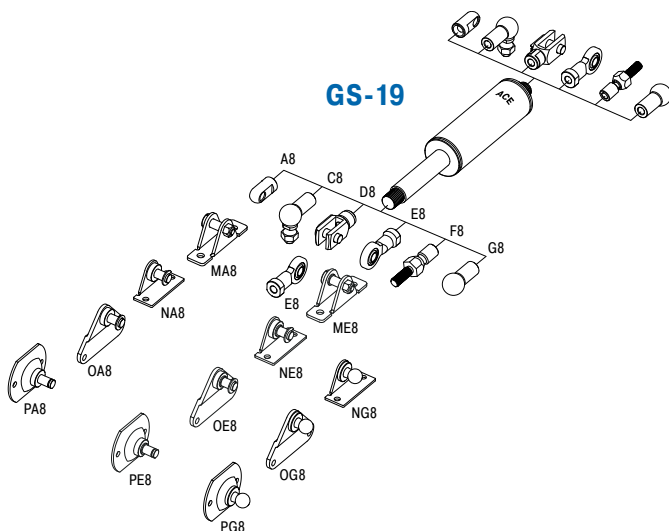
Safety instructions: Gas springs (push type) should not be installed under pre-tension.

Valve Technology, Extension force 80 N to 1,300 N (compressed up to 1,820 N)

End Fitting

Standard Dimensions

End Fitting

A8

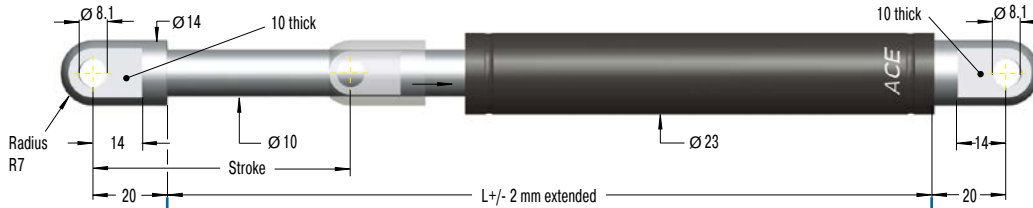

Eye A8
max. force 3,000 N

B8



Stud Thread B8

C8

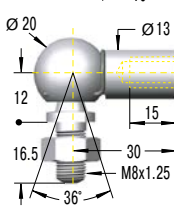

Angle Ball Joint C8
max. force 1,200 N

D8

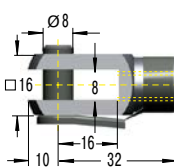

Clevis Fork D8
max. force 3,000 N

E8

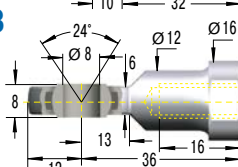

Swivel Eye E8
max. force 3,000 N

F8

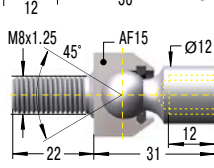

Inline Ball Joint F8
max. force 1,200 N

G8

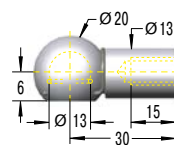

Ball Socket G8
max. force 1,200 N

Rod Shroud W8-22

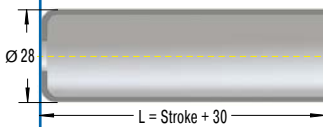

Performance and Dimensions

TYPES	Stroke mm	L extended mm	Extension force max. N
GS-22-50	50	164	1,300
GS-22-100	100	264	1,300
GS-22-150	150	364	1,300
GS-22-200	200	464	1,300
GS-22-250	250	564	1,300
GS-22-300	300	664	1,100
GS-22-350	350	764	850
GS-22-400	400	864	650
GS-22-450	450	964	550
GS-22-500	500	1,064	450
GS-22-550	550	1,164	400
GS-22-600	600	1,264	350
GS-22-650	650	1,364	300
GS-22-700	700	1,464	250

Ordering Example

GS-22-150-AE-800

Type (Push Type) _____
 Body Ø (23 mm) _____
 Stroke (150 mm) _____
 Piston Rod End Fitting A8 _____
 Body End Fitting E8 _____
 Nominal Force F₁ 800 N _____

Mounting accessories see from page 200.

Adjuster Knob
DE-GAS-8
See page 175.

Technical Data

Extension force: 80 N to 1,300 N (compressed up to 1,820 N)

Progression: Approx. 30 % to 40 %

Operating temperature range: -20 °C to +80 °C

Material: Outer body: steel coated with UV paint; Piston rod: steel with wear-resistant coating; End fittings: zinc plated steel

Mounting: In any position. Hint: We recommend mounting with piston rod downwards to take advantage of the built-in end position damping.

End position damping length: approx. 20 mm to 70 mm (depending on the stroke)

Positive stop: External positive stop at the end of stroke provided by the customer.

Note: Integrated grease chamber reduces friction and wear and optimises lubrication.

End fittings: They are interchangeable and if necessary must be positively secured by the customer to prevent unscrewing.

Safety instructions: Gas springs (push type) should not be installed under pre-tension.

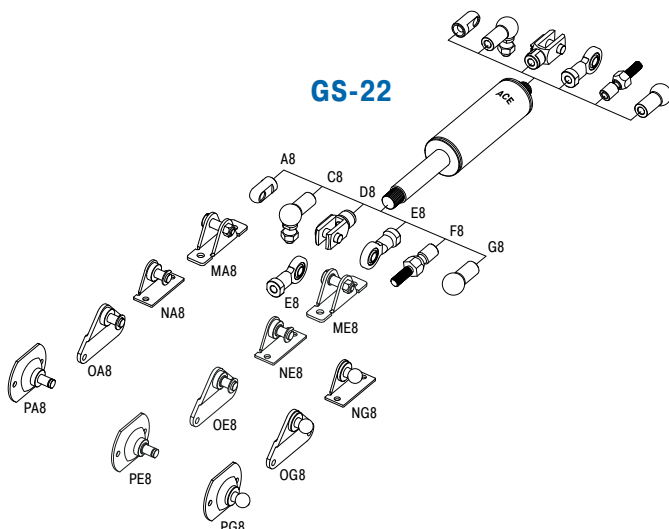

Valve Technology, Extension force 150 N to 2,500 N (compressed up to 4,400 N)

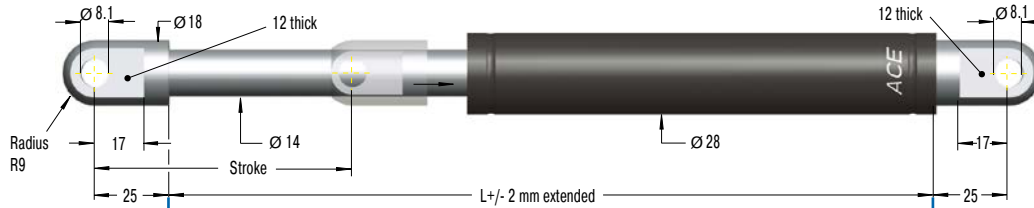
End Fitting
Standard Dimensions
End Fitting
A10

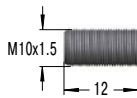
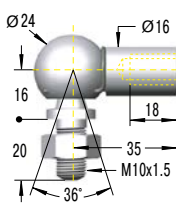
Eye A10
max. force 10,000 N

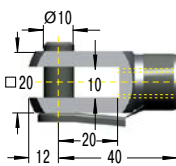
B10

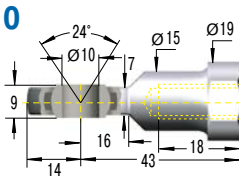
Stud Thread B10
C10

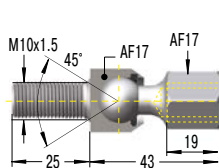
Angle Ball Joint C10
max. force 1,800 N

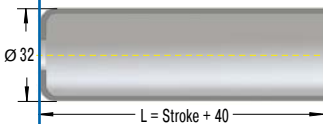
D10

Clevis Fork D10
max. force 10,000 N

E10

Swivel Eye E10
max. force 10,000 N

F10

Inline Ball Joint F10
max. force 1,800 N

Rod Shroud W10-28

Performance and Dimensions

TYPES	Stroke mm	L extended mm	Extension force max. N
GS-28-100	100	262	2,500
GS-28-150	150	362	2,500
GS-28-200	200	462	2,500
GS-28-250	250	562	2,500
GS-28-300	300	662	2,500
GS-28-350	350	762	2,500
GS-28-400	400	862	2,400
GS-28-450	450	962	1,950
GS-28-500	500	1,062	1,600
GS-28-550	550	1,162	1,350
GS-28-600	600	1,262	1,150
GS-28-650	650	1,362	1,000
GS-28-700	700	1,462	900
GS-28-750	750	1,562	800

Ordering Example
GS-28-150-EE-1200

Type (Push Type) _____
 Body Ø (28 mm) _____
 Stroke (150 mm) _____
 Piston Rod End Fitting E10 _____
 Body End Fitting E10 _____
 Nominal Force F₁ 1200 N _____

Mounting accessories see from page 200.

**Adjuster Knob
DE-GAS-10**
See page 175.

Technical Data
Extension force: 150 N to 2,500 N (compressed up to 4,400 N)

Progression: Approx. 63 % to 76 %

Operating temperature range: -20 °C to +80 °C

Material: Outer body: steel coated with UV paint; Piston rod: steel with wear-resistant coating; End fittings: zinc plated steel

Mounting: In any position. Hint: We recommend mounting with piston rod downwards to take advantage of the built-in end position damping.

End position damping length: approx. 30 mm to 70 mm (depending on the stroke)

Positive stop: External positive stop at the end of stroke provided by the customer.

Note: Integrated grease chamber reduces friction and wear and optimises lubrication.

End fittings: They are interchangeable and if necessary must be positively secured by the customer to prevent unscrewing.

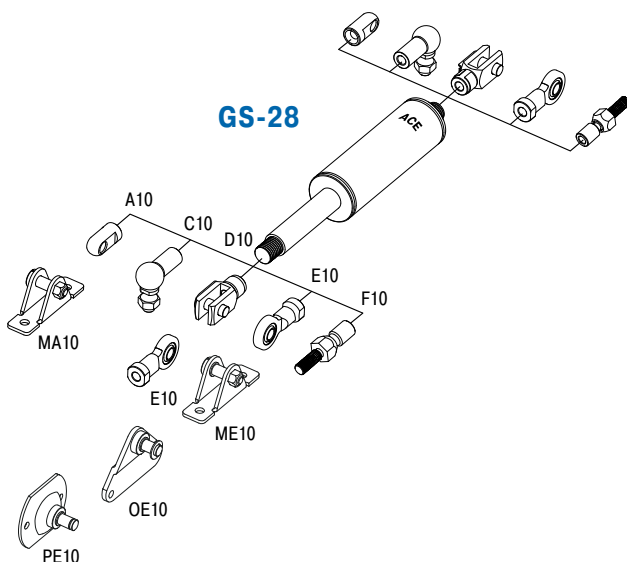
Safety instructions: Gas springs (push type) should not be installed under pre-tension.

Valve Technology, Extension force 500 N to 5,000 N (compressed up to 7,500 N)

End Fitting

Standard Dimensions

End Fitting

A14

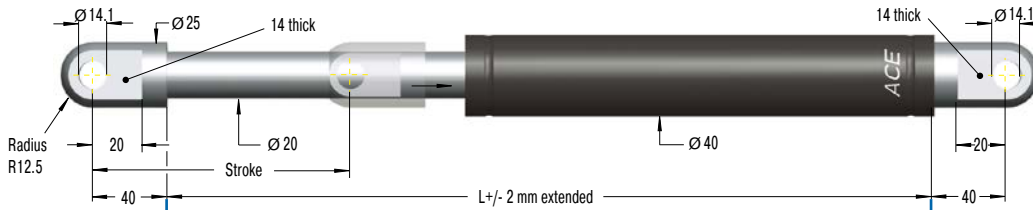

Eye A14
max. force 10,000 N

B14

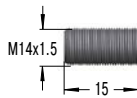

Stud Thread B14

C14

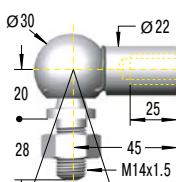

Angle Ball Joint C14
max. force 3,200 N

D14

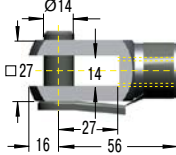

Clevis Fork D14
max. force 10,000 N

E14

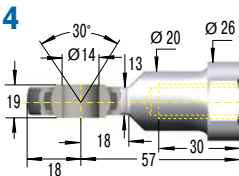

Swivel Eye E14
max. force 10,000 N

F14

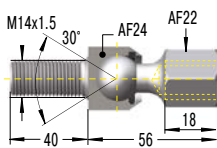

Inline Ball Joint F14
max. force 3,200 N

Rod Shroud W14-40

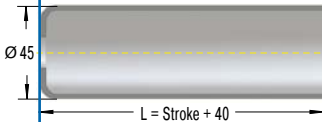

Performance and Dimensions

TYPES	Stroke mm	L extended mm	Extension force max. N
GS-40-100	100	317	5,000
GS-40-150	150	417	5,000
GS-40-200	200	517	5,000
GS-40-250	250	617	5,000
GS-40-300	300	717	5,000
GS-40-400	400	917	5,000
GS-40-500	500	1,117	5,000
GS-40-600	600	1,317	4,150
GS-40-800	800	1,717	2,550
GS-40-1000	1,000	2,117	1,700

Ordering Example

GS-40-150-DD-3500

Type (Push Type) _____
 Body Ø (40 mm) _____
 Stroke (150 mm) _____
 Piston Rod End Fitting D14 _____
 Body End Fitting D14 _____
 Nominal Force F₁ 3500 N _____

Mounting accessories see from page 200.

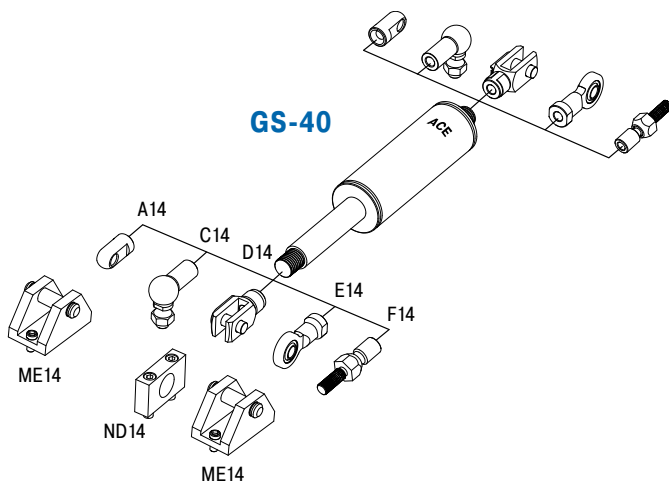

Technical Data

Extension force: 500 N to 5,000 N (compressed up to 7,500 N)

Progression: Approx. 38 % to 50 %

Operating temperature range: -20 °C to +80 °C

Material: Outer body: steel coated with UV paint; Piston rod: steel with wear-resistant coating; End fittings: zinc plated steel

Mounting: In any position. Hint: We recommend mounting with piston rod downwards to take advantage of the built-in end position damping.

End position damping length: approx. 30 mm to 70 mm (depending on the stroke)

Positive stop: External positive stop at the end of stroke provided by the customer.

Note: Integrated grease chamber reduces friction and wear and optimises lubrication.

End fittings: They are interchangeable and if necessary must be positively secured by the customer to prevent unscrewing.

Safety instructions: Gas springs (push type) should not be installed under pre-tension.

Adjuster Knob DE-GAS-14

See page 175.

Valve Technology, Extension force 2,000 N to 13,000 N (compressed up to 16,250 N)

End Fitting

Standard Dimensions

End Fitting

B24

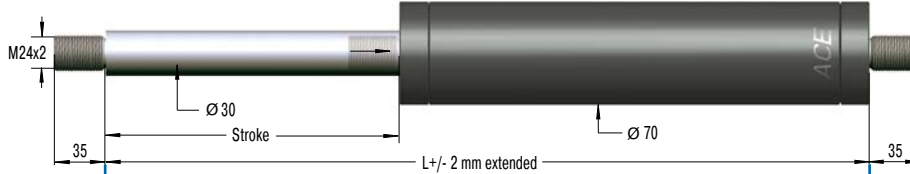

Stud Thread B24

D24

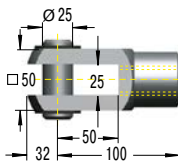

Clevis Fork D24
max. force 50,000 N

E24

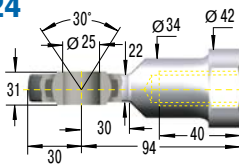

Swivel Eye E24
max. force 50,000 N

Rod Shroud W24-70

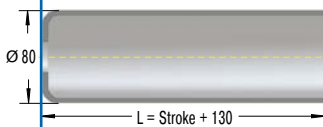

Performance and Dimensions

TYPES	Stroke mm	L extended mm	Extension force max. N
GS-70-100	100	320	13,000
GS-70-200	200	520	13,000
GS-70-300	300	720	13,000
GS-70-400	400	920	13,000
GS-70-500	500	1,120	13,000
GS-70-600	600	1,320	13,000
GS-70-700	700	1,520	13,000
GS-70-800	800	1,720	11,550

Ordering Example

GS-70-200-EE-8000

Type (Push Type) _____
 Body Ø (70 mm) _____
 Stroke (200 mm) _____
 Piston Rod End Fitting E24 _____
 Body End Fitting E24 _____
 Nominal Force F₁ 8000 N _____

Mounting accessories see from page 200.

Technical Data

Extension force: 2,000 N to 13,000 N (compressed up to 16,250 N)

Progression: Approx. 25 %

Operating temperature range: -20 °C to +80 °C

Material: Outer body: coated steel; Piston rod: hard chrome plated steel; End fittings: zinc plated steel

Mounting: In any position. Hint: We recommend mounting with piston rod downwards to take advantage of the built-in end position damping.

End position damping length: approx. 10 mm to 20 mm (depending on the stroke)

Positive stop: External positive stop at the end of stroke provided by the customer.

Note: Increased break-away force if unit has not moved for some time.

End fittings: They are interchangeable and if necessary must be positively secured by the customer to prevent unscrewing.

Safety instructions: Gas springs (push type) should not be installed under pre-tension.

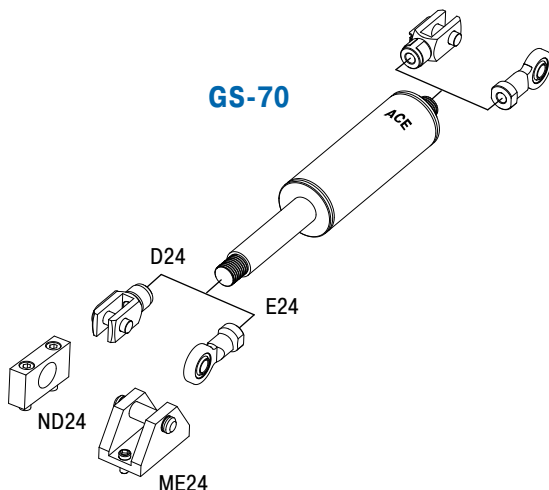

GS-8-V4A to GS-40-VA

With food grade oil according to FDA approval

Valve Technology, Stainless Steel

Force range 10 N to 5,000 N

Stroke 20 mm to 700 mm

Protection against corrosion and superior optics for even more sophisticated requirements: Based on ACE's industrial gas push type springs GS-8 to 40 made of steel, these models combine all advantages of stainless steel: they look great and are rust free. They are filled with food-grade oil as standard, which conforms to the requirements of FDA 21 CFR 178.3570.

These ACE gas push type springs do not only look good, they also are available in various stroke lengths and possible extension forces. A comprehensive range of accessories in stainless steel guarantees easy assembly and a broad range of uses.

ACE industrial gas pressure springs made of stainless steel are used in the automotive sector, in industrial applications, mechanical engineering and medical cleanroom technology as well as in the food, electronics and shipbuilding industries.

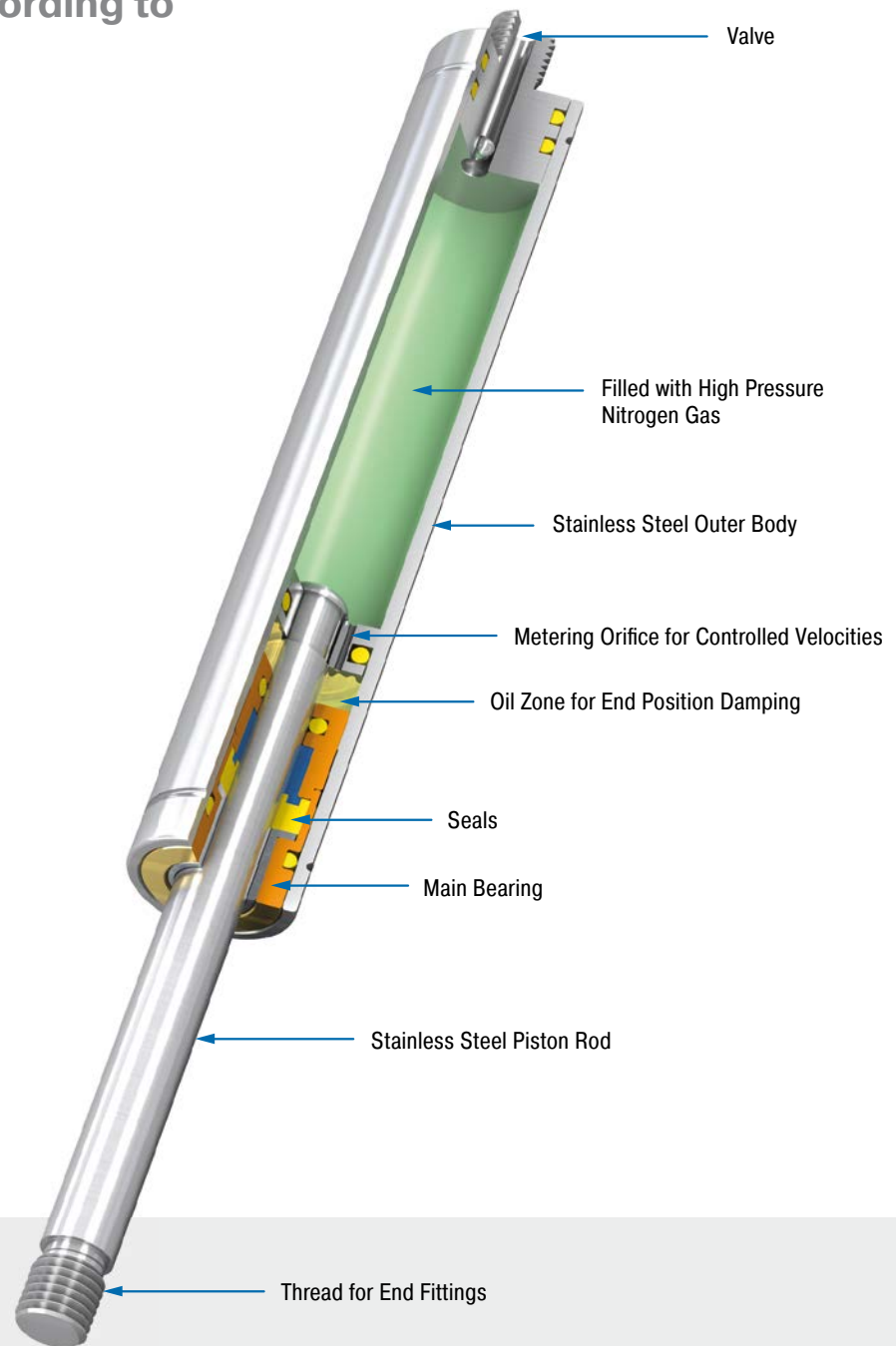

Technical Data

Extension force: 10 N to 5,000 N

Piston rod diameter: Ø 3 mm to Ø 20 mm

Progression: approx. 13 % to 59 % (depending on size and stroke)

Lifetime: Approx. 10.000 m

Operating temperature range: -20 °C to +80 °C

Material: Outer body, Piston rod, End fittings: stainless steel (1.4301/1.4305, AISI 304/303 and 1.4404/1.4571, AISI 316L/316Ti)

Operating fluid: nitrogen gas and HLP oil according to DIN 51524, part 2

Mounting: We recommend mounting with piston rod downwards to take advantage of the built-in end position damping.

End position damping length: Approx. 5 mm to 30 mm (depending on the stroke)

Positive stop: External positive stop at the end of stroke provided by the customer.

Application field: hoods, shutters, machine housing, conveyor systems, control boxes, furniture industry, shipbuilding, food industry, pharmaceutical industry, folding elements

Note: Special oil according to FDA 21 CFR 178.3570 of the food industry

End fittings: They are interchangeable and if necessary must be positively secured by the customer to prevent unscrewing.

Safety instructions: Gas pressure springs should not be installed under pre-tension.

On request: Special oils and other special options. Alternative accessories. Different end position damping and extension speed. Other gas springs material 1.4404/1.4571, AISI 316L/316Ti (V4A) available on request.

Valve Technology, Stainless Steel, Extension force 10 N to 100 N (compressed up to 131 N)

End Fitting
Standard Dimensions
End Fitting

B3,5

A3,5-V4A

C3,5-V4A

D3,5-V4A

G3,5-V4A

Stud Thread B3,5

Eye A3,5-V4A
max. force 370 N

Angle Ball Joint C3,5-V4A
max. force 370 N

Clevis Fork D3,5-V4A
max. force 370 N

Ball Socket G3,5-V4A
max. force 370 N

Adjuster Knob DE-GAS-3,5
See page 175.

Performance and Dimensions			
TYPES	Stroke mm	L extended mm	Extension force max. N
GS-8-20-V4A	20	72	100
GS-8-30-V4A	30	92	100
GS-8-40-V4A	40	112	100
GS-8-50-V4A	50	132	100
GS-8-60-V4A	60	152	100
GS-8-80-V4A	80	192	100

Ordering Example **GS-8-30-AC-30-V4A**

Type (Push Type) _____

Body Ø (8 mm) _____

Stroke (30 mm) _____

Piston Rod End Fitting A3,5-V4A _____

Body End Fitting C3,5-V4A _____

Nominal Force F_1 30 N _____

Material (1.4404/1.4571, AISI 316L/316Ti, V4A) _____

Mounting accessories see from page 208.

Technical Data
Extension force: 10 N to 100 N (compressed up to 131 N)

Progression: Approx. 28 % to 31 %

Operating temperature range: -20 °C to +80 °C

Material: Outer body, Piston rod, End fittings: stainless steel (1.4404/1.4571, AISI 316L/316Ti)

Mounting: We recommend mounting with piston rod downwards to take advantage of the built-in end position damping.

End position damping length: approx. 5 mm (depending on the stroke)

Positive stop: External positive stop at the end of stroke provided by the customer.

Note: Special oil according to FDA 21 CFR 178.3570 of the food industry

End fittings: They are interchangeable and if necessary must be positively secured by the customer to prevent unscrewing.

Safety instructions: Gas pressure springs should not be installed under pre-tension.

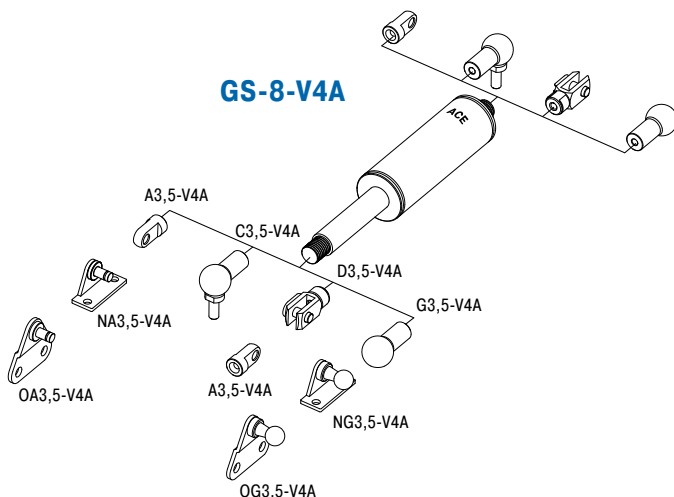
GS-8-V4A

Valve Technology, Stainless Steel, Extension force 10 N to 100 N (compressed up to 116 N)

End Fitting

Standard Dimensions

End Fitting

B3,5 Stud Thread **B3,5**

A3,5-V4A Eye **A3,5-V4A** max. force 370 N

C3,5-V4A Angle Ball Joint **C3,5-V4A** max. force 370 N

D3,5-V4A Clevis Fork **D3,5-V4A** max. force 370 N

G3,5-V4A Ball Socket **G3,5-V4A** max. force 370 N

Adjuster Knob DE-GAS-3,5 See page 175.

Performance and Dimensions			
TYPES	Stroke mm	L extended mm	Extension force max. N
GS-10-20-V4A	20	72	100
GS-10-30-V4A	30	92	100
GS-10-40-V4A	40	112	100
GS-10-50-V4A	50	132	100
GS-10-60-V4A	60	152	100
GS-10-80-V4A	80	192	100

Ordering Example **GS-10-30-AC-30-V4A**

Type (Push Type) _____
 Body Ø (10 mm) _____
 Stroke (30 mm) _____
 Piston Rod End Fitting A3,5-V4A _____
 Body End Fitting C3,5-V4A _____
 Nominal Force F₁ 30 N _____
 Material (1.4404/1.4571, AISI 316L/316Ti, V4A) _____

Mounting accessories see from page 208.

Technical Data

- Extension force:** 10 N to 100 N (compressed up to 116 N)
- Progression:** Approx. 13 % to 16 %
- Operating temperature range:** -20 °C to +80 °C
- Material:** Outer body, Piston rod, End fittings: stainless steel (1.4404/1.4571, AISI 316L/316Ti)
- Mounting:** We recommend mounting with piston rod downwards to take advantage of the built-in end position damping.
- End position damping length:** approx. 5 mm (depending on the stroke)
- Positive stop:** External positive stop at the end of stroke provided by the customer.
- Note:** Special oil according to FDA 21 CFR 178.3570 of the food industry
- End fittings:** They are interchangeable and if necessary must be positively secured by the customer to prevent unscrewing.
- Safety instructions:** Gas pressure springs should not be installed under pre-tension.

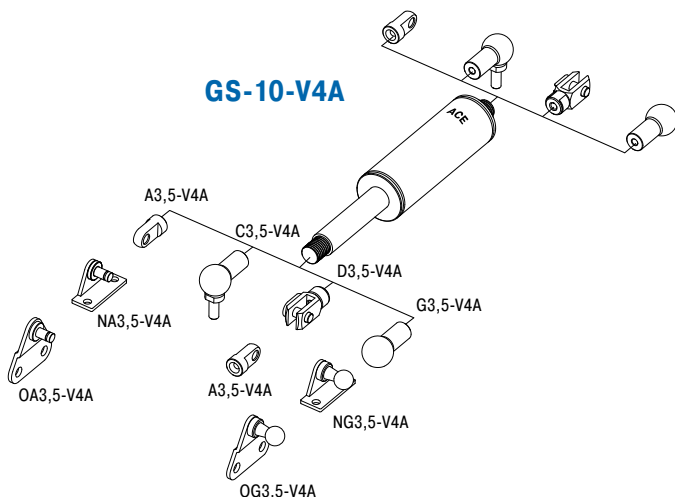

Issue 07.2017 – Specifications subject to change

Valve Technology, Stainless Steel, Extension force 15 N to 180 N (compressed up to 225 N)

End Fitting
Standard Dimensions
End Fitting

B3,5

A3,5-V4A

C3,5-V4A

D3,5-V4A

G3,5-V4A

Performance and Dimensions

TYPES	Stroke mm	L extended mm	Extension force max. N
GS-12-20-V4A	20	72	180
GS-12-30-V4A	30	92	180
GS-12-40-V4A	40	112	180
GS-12-50-V4A	50	132	180
GS-12-60-V4A	60	152	180
GS-12-80-V4A	80	192	150
GS-12-100-V4A	100	232	150
GS-12-120-V4A	120	272	120
GS-12-150-V4A	150	332	100

Ordering Example

GS-12-100-AA-30-V4A

Type (Push Type) _____

Body Ø (12 mm) _____

Stroke (100 mm) _____

Piston Rod End Fitting A3,5-V4A _____

Body End Fitting A3,5-V4A _____

Nominal Force F₁ 30 N _____

Material (1.4404/1.4571, AISI 316L/316Ti, V4A) _____

Stud Thread B3,5

Eye A3,5-V4A
max. force 370 N

Angle Ball Joint C3,5-V4A
max. force 370 N

Clevis Fork D3,5-V4A
max. force 370 N

Ball Socket G3,5-V4A
max. force 370 N

Adjuster Knob DE-GAS-3,5
See page 175.

Mounting accessories see from page 208.

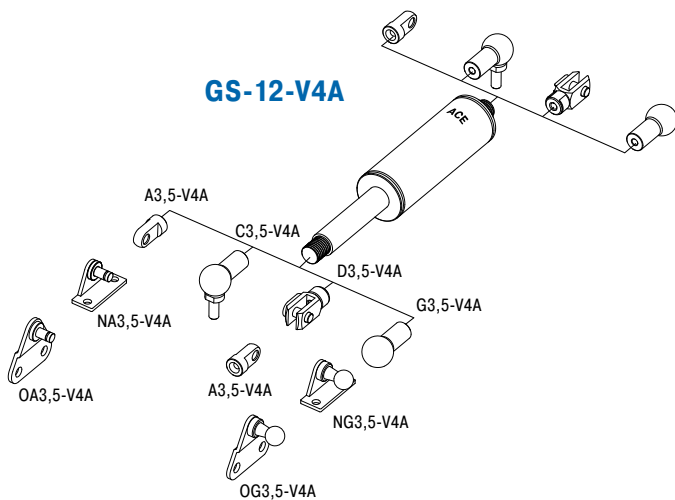
Technical Data
Extension force: 15 N to 180 N (compressed up to 225 N)

Progression: Approx. 20 % to 25 %

Operating temperature range: -20 °C to +80 °C

Material: Outer body, Piston rod, End fittings: stainless steel (1.4404/1.4571, AISI 316L/316Ti)

Mounting: We recommend mounting with piston rod downwards to take advantage of the built-in end position damping.

End position damping length: approx. 10 mm (depending on the stroke)

Positive stop: External positive stop at the end of stroke provided by the customer.

Note: Special oil according to FDA 21 CFR 178.3570 of the food industry

End fittings: They are interchangeable and if necessary must be positively secured by the customer to prevent unscrewing.

Safety instructions: Gas pressure springs should not be installed under pre-tension.

Valve Technology, Stainless Steel, Extension force 40 N to 400 N (compressed up to 612 N)

End Fitting

Standard Dimensions

End Fitting

Performance and Dimensions

TYPES	Stroke mm	L extended mm	Extension force max. N
GS-15-20-VA	20	74	400
GS-15-40-VA	40	114	400
GS-15-50-VA	50	134	400
GS-15-60-VA	60	154	400
GS-15-80-VA	80	194	400
GS-15-100-VA	100	234	400
GS-15-120-VA	120	274	400
GS-15-150-VA	150	334	400

Ordering Example

GS-15-150-AC-150-VA

- Type (Push Type)
- Body Ø (15.6 mm)
- Stroke (150 mm)
- Piston Rod End Fitting A5-VA
- Body End Fitting C5-VA
- Nominal Force F_1 150 N
- Material (1.4301/1.4305, AISI 304/303, VA)

Adjuster Knob DE-GAS-5
See page 175.

Mounting accessories see from page 208.

Technical Data

- Extension force:** 40 N to 400 N (compressed up to 612 N)
- Progression:** Approx. 30 % to 53 %
- Operating temperature range:** -20 °C to +80 °C
- Material:** Outer body, Piston rod, End fittings: stainless steel (1.4301/1.4305, AISI 304/303)
- Mounting:** We recommend mounting with piston rod downwards to take advantage of the built-in end position damping.
- End position damping length:** approx. 20 mm (depending on the stroke)
- Positive stop:** External positive stop at the end of stroke provided by the customer.
- Note:** Special oil according to FDA 21 CFR 178.3570 of the food industry
- End fittings:** They are interchangeable and if necessary must be positively secured by the customer to prevent unscrewing.
- Safety instructions:** Gas pressure springs should not be installed under pre-tension.

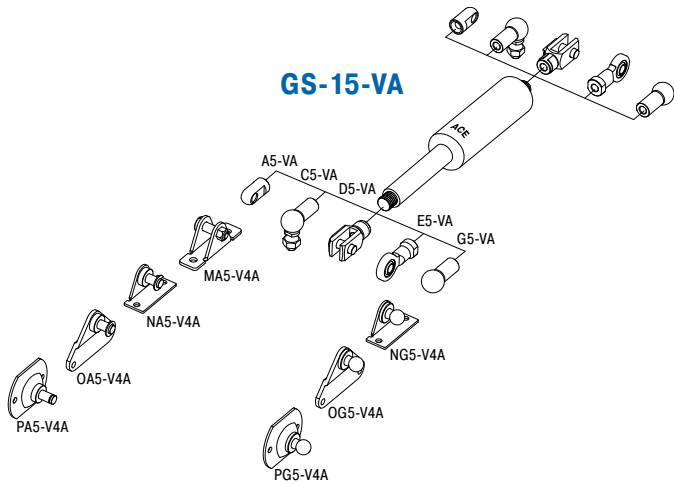

Issue 07.2017 – Specifications subject to change

Valve Technology, Stainless Steel, Extension force 50 N to 700 N (compressed up to 924 N)

End Fitting
Standard Dimensions
End Fitting

Performance and Dimensions

TYPES	Stroke mm	L extended mm	Extension force max. N
GS-19-50-VA	50	164	700
GS-19-100-VA	100	264	700
GS-19-150-VA	150	364	700
GS-19-200-VA	200	464	700
GS-19-250-VA	250	564	600
GS-19-300-VA	300	664	450

Ordering Example

GS-19-150-AC-600-VA

Type (Push Type) _____
 Body Ø (19 mm) _____
 Stroke (150 mm) _____
 Piston Rod End Fitting A8-VA _____
 Body End Fitting C8-VA _____
 Nominal Force F₁ 600 N _____
 Material (1.4301/1.4305, AISI 304/303, VA) _____

Mounting accessories see from page 208.

Adjuster Knob DE-GAS-8
See page 175.

End Fitting Options:
 Stud Thread **B8**
 Eye **A8-VA** max. force 1,560 N
 Angle Ball Joint **C8-VA** max. force 1,140 N
 Clevis Fork **D8-VA** max. force 1,560 N
 Swivel Eye **E8-VA** max. force 1,560 N
 Ball Socket **G8-VA** max. force 1,140 N

Technical Data
Extension force: 50 N to 700 N (compressed up to 924 N)

Progression: Approx. 28 % to 32 %

Operating temperature range: -20 °C to +80 °C

Material: Outer body, Piston rod, End fittings: stainless steel (1.4301/1.4305, AISI 304/303)

Mounting: We recommend mounting with piston rod downwards to take advantage of the built-in end position damping.

End position damping length: approx. 20 mm (depending on the stroke)

Positive stop: External positive stop at the end of stroke provided by the customer.

Note: Special oil according to FDA 21 CFR 178.3570 of the food industry

End fittings: They are interchangeable and if necessary must be positively secured by the customer to prevent unscrewing.

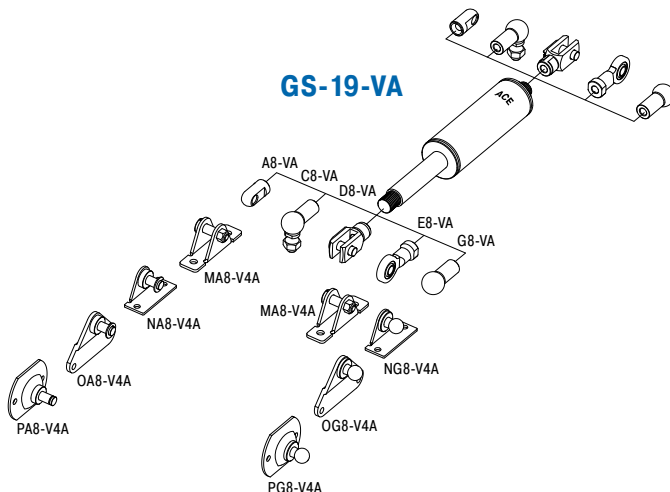
Safety instructions: Gas pressure springs should not be installed under pre-tension.

End Fitting

Standard Dimensions

End Fitting

B8

A8-VA

C8-VA

D8-VA

E8-VA

G8-VA

Rod Shroud W8-22-VA

Stud Thread B8

Eye A8-VA
max. force 1,560 N

Angle Ball Joint C8-VA
max. force 1,140 N

Clevis Fork D8-VA
max. force 1,560 N

Swivel Eye E8-VA
max. force 1,560 N

Ball Socket G8-VA
max. force 1,140 N

Adjuster Knob DE-GAS-8
See page 175.

TYPES	Stroke mm	L extended mm	Extension force max. N
GS-22-50-VA	50	164	1,200
GS-22-100-VA	100	264	1,200
GS-22-150-VA	150	364	1,200
GS-22-200-VA	200	464	1,200
GS-22-250-VA	250	564	1,200
GS-22-300-VA	300	664	1,100
GS-22-350-VA	350	764	850
GS-22-400-VA	400	864	650
GS-22-450-VA	450	964	550
GS-22-500-VA	500	1,064	450
GS-22-550-VA	550	1,164	400
GS-22-600-VA	600	1,264	350
GS-22-650-VA	650	1,364	300
GS-22-700-VA	700	1,464	250

Ordering Example

Type (Push Type) _____

Body Ø (23 mm) _____

Stroke (150 mm) _____

Piston Rod End Fitting A8-VA _____

Body End Fitting E8-VA _____

Nominal Force F₁ 800 N _____

Material (1.4301/1.4305, AISI 304/303, VA) _____

GS-22-150-AE-800-VA

Mounting accessories see from page 208.

Technical Data

- Extension force:** 100 N to 1,200 N (compressed up to 1,596 N)
- Progression:** Approx. 29 % to 33 %
- Operating temperature range:** -20 °C to +80 °C
- Material:** Outer body, Piston rod, End fittings: stainless steel (1.4301/1.4305, AISI 304/303)
- Mounting:** We recommend mounting with piston rod downwards to take advantage of the built-in end position damping.
- End position damping length:** approx. 20 mm (depending on the stroke)
- Positive stop:** External positive stop at the end of stroke provided by the customer.
- Note:** Special oil according to FDA 21 CFR 178.3570 of the food industry
- End fittings:** They are interchangeable and if necessary must be positively secured by the customer to prevent unscrewing.
- Safety instructions:** Gas pressure springs should not be installed under pre-tension.

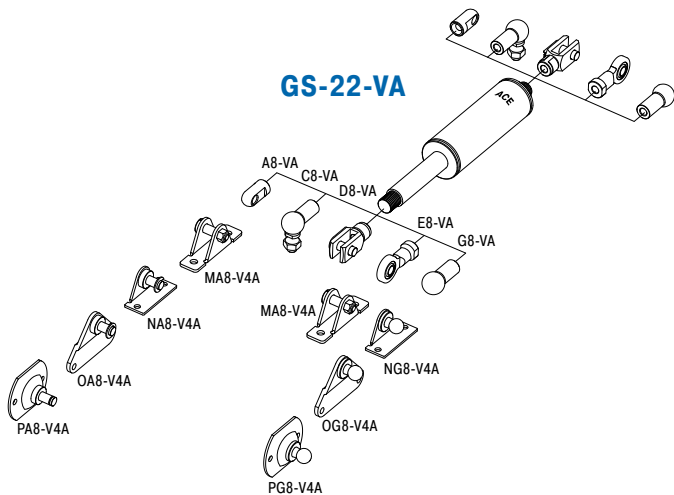

Valve Technology, Stainless Steel, Extension force 150 N to 2,500 N (compressed up to 3,975 N)

End Fitting

Standard Dimensions

End Fitting

B10 Stud Thread B10

A10-VA Eye A10-VA max. force 3,800 N

C10-VA Angle Ball Joint C10-VA max. force 1,750 N

D10-VA Clevis Fork D10-VA max. force 3,800 N

E10-VA Swivel Eye E10-VA max. force 3,800 N

Rod Shroud W10-28-VA $L = \text{Stroke} + 40$

Adjuster Knob DE-GAS-10 See page 175.

Performance and Dimensions

TYPES	Stroke mm	L extended mm	Extension force max. N
GS-28-100-VA	100	262	2,500
GS-28-150-VA	150	362	2,500
GS-28-200-VA	200	462	2,500
GS-28-250-VA	250	562	2,500
GS-28-300-VA	300	662	2,500
GS-28-350-VA	350	762	2,500
GS-28-400-VA	400	862	2,400
GS-28-450-VA	450	962	1,950
GS-28-500-VA	500	1,062	1,600
GS-28-550-VA	550	1,162	1,350
GS-28-600-VA	600	1,262	1,150
GS-28-650-VA	650	1,362	1,000

Ordering Example

GS-28-150-EE-1200-VA

Type (Push Type) _____

Body Ø (28 mm) _____

Stroke (150 mm) _____

Piston Rod End Fitting E10-VA _____

Body End Fitting E10-VA _____

Nominal Force F_1 1200 N _____

Material (1.4301/1.4305, AISI 304/303, VA) _____

Mounting accessories see from page 208.

Technical Data

Extension force: 150 N to 2,500 N (compressed up to 3,975 N)

Progression: Approx. 53 % to 59 %

Operating temperature range: -20 °C to +80 °C

Material: Outer body, Piston rod, End fittings: stainless steel (1.4301/1.4305, AISI 304/303)

Mounting: We recommend mounting with piston rod downwards to take advantage of the built-in end position damping.

End position damping length: approx. 20 mm (depending on the stroke)

Positive stop: External positive stop at the end of stroke provided by the customer.

Note: Special oil according to FDA 21 CFR 178.3570 of the food industry

End fittings: They are interchangeable and if necessary must be positively secured by the customer to prevent unscrewing.

Safety instructions: Gas pressure springs should not be installed under pre-tension.

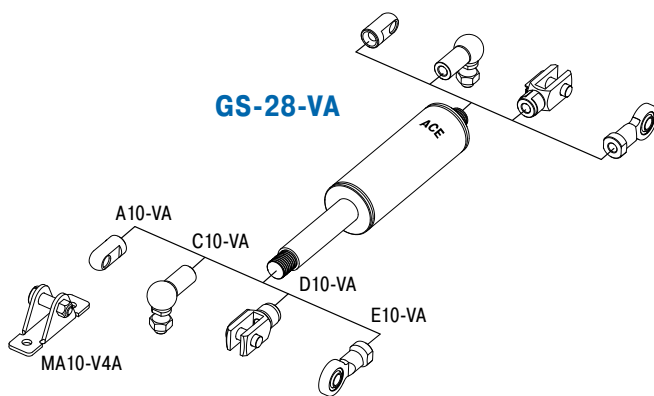

End Fitting

Standard Dimensions

End Fitting

Performance and Dimensions

TYPES	Stroke mm	L extended mm	Extension force max. N
GS-40-100-VA	100	317	5,000
GS-40-150-VA	150	417	5,000
GS-40-200-VA	200	517	5,000
GS-40-300-VA	300	717	5,000
GS-40-400-VA	400	917	5,000
GS-40-500-VA	500	1,117	5,000
GS-40-600-VA	600	1,317	4,150

Ordering Example

GS-40-150-DD-3500-VA

Type (Push Type) _____
 Body Ø (40 mm) _____
 Stroke (150 mm) _____
 Piston Rod End Fitting D14-VA _____
 Body End Fitting D14-VA _____
 Nominal Force F₁ 3500 N _____
 Material (1.4301/1.4305, AISI 304/303, VA) _____

End Fitting Options:
 Stud Thread **B14**
 Eye **A14-VA** max. force 7,000 N
 Angle Ball Joint **C14-VA** max. force 3,200 N
 Clevis Fork **D14-VA** max. force 7,000 N
 Swivel Eye **E14-VA** max. force 7,000 N
 Rod Shroud **W14-40-VA**
 Adjuster Knob **DE-GAS-14** See page 175.

Mounting accessories see from page 208.

Technical Data

- Extension force:** 500 N to 5,000 N (compressed up to 7,100 N)
- Progression:** Approx. 34 % to 42 %
- Operating temperature range:** -20 °C to +80 °C
- Material:** Outer body, Piston rod, End fittings: stainless steel (1.4301/1.4305, AISI 304/303)
- Mounting:** We recommend mounting with piston rod downwards to take advantage of the built-in end position damping.
- End position damping length:** approx. 30 mm (depending on the stroke)
- Positive stop:** External positive stop at the end of stroke provided by the customer.
- Note:** Special oil according to FDA 21 CFR 178.3570 of the food industry
- End fittings:** They are interchangeable and if necessary must be positively secured by the customer to prevent unscrewing.
- Safety instructions:** Gas pressure springs should not be installed under pre-tension.

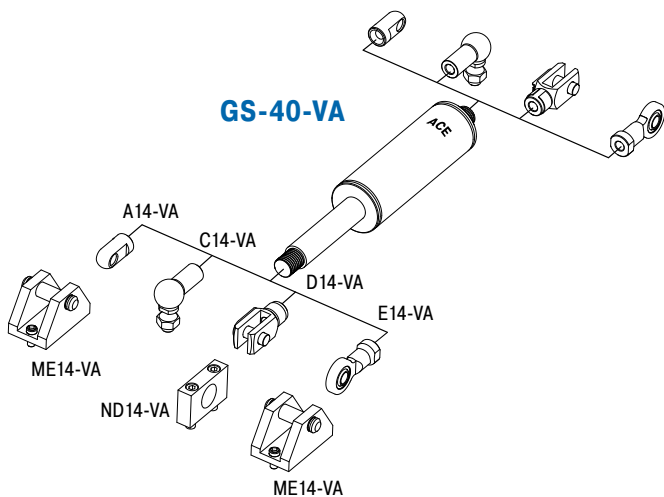

Stainless Steel Gas Springs (Push Type), V4A

TYPES	Stroke mm	L extended mm	Dimensions see Page
GS-15-20-V4A	20	74	148
GS-15-40-V4A	40	114	148
GS-15-50-V4A	50	134	148
GS-15-60-V4A	60	154	148
GS-15-80-V4A	80	194	148
GS-15-100-V4A	100	234	148
GS-15-120-V4A	120	274	148
GS-15-150-V4A	150	334	148
GS-19-50-V4A	50	164	149
GS-19-100-V4A	100	264	149
GS-19-150-V4A	150	364	149
GS-19-200-V4A	200	464	149
GS-19-250-V4A	250	564	149
GS-19-300-V4A	300	664	149
GS-22-50-V4A	50	164	150
GS-22-100-V4A	100	264	150
GS-22-150-V4A	150	364	150
GS-22-200-V4A	200	464	150
GS-22-250-V4A	250	564	150
GS-22-300-V4A	300	664	150
GS-22-350-V4A	350	764	150
GS-22-400-V4A	400	864	150
GS-22-450-V4A	450	964	150
GS-22-500-V4A	500	1,064	150
GS-22-550-V4A	550	1,164	150
GS-22-600-V4A	600	1,264	150
GS-22-650-V4A	650	1,364	150
GS-22-700-V4A	700	1,464	150
GS-28-100-V4A	100	262	151
GS-28-150-V4A	150	362	151
GS-28-200-V4A	200	462	151
GS-28-250-V4A	250	562	151
GS-28-300-V4A	300	662	151
GS-28-350-V4A	350	762	151
GS-28-400-V4A	400	862	151
GS-28-450-V4A	450	962	151
GS-28-500-V4A	500	1,062	151
GS-28-550-V4A	550	1,162	151
GS-28-600-V4A	600	1,262	151
GS-28-650-V4A	650	1,362	151
GS-40-100-V4A	100	317	152
GS-40-150-V4A	150	417	152
GS-40-200-V4A	200	517	152
GS-40-300-V4A	300	717	152
GS-40-400-V4A	400	917	152
GS-40-500-V4A	500	1,117	152
GS-40-600-V4A	600	1,317	152

Stainless Steel Accessories, V4A

TYPES	Dimensions see Page
A5-V4A	210
C5-V4A	210
D5-V4A	210
E5-V4A	210
G5-V4A	210
A8-V4A	211
C8-V4A	211
D8-V4A	211
E8-V4A	211
G8-V4A	212
A10-V4A	212
C10-V4A	212
D10-V4A	212
E10-V4A	212
A14-V4A	213
C14-V4A	213
D14-V4A	213
E14-V4A	213

GST-40 Tandem

Optimised dual force for heavy flaps and wide angle applications

Valve Technology

Force range 300 N to 5,000 N

Stroke 50 mm to 400 mm

Cover two differing force ranges: Tandem push type gas springs by ACE are maintenance-free and ready-to-install with two pressure tubes with different extension forces and progression curves. With this type of gas spring you cover the different force ranges between the start and end of an application. These force ranges are adjusted and complement each other, designed individually for the relevant application by the free of charge ACE calculation service, then are specifically manufactured adjusted precisely to the required dynamics of the application.

The customer specific systems, for which there are many fitting parts, are specifically suitable for heavy loads with large opening angle and can also be delivered in stainless steel versions.

Tandem push type gas springs from ACE are used in industrial applications such as in mechanical engineering, in the automobile, electronics and furniture industries, but also in medical technology as well as for service hatches.

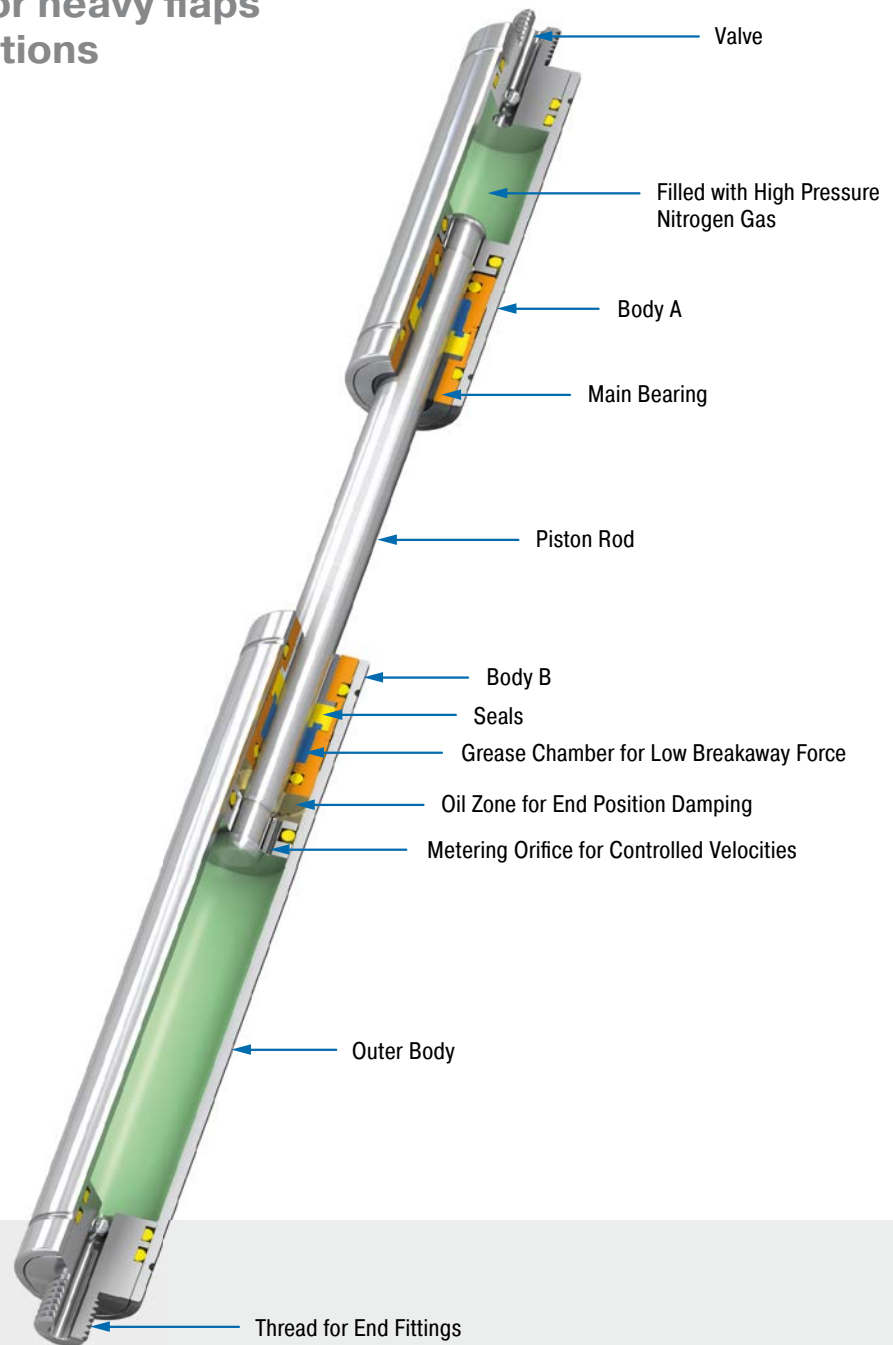

Technical Data

Extension force: 300 N to 5,000 N

Piston rod diameter: Ø 20 mm

Progression: according to calculation relating to your application

Lifetime: Approx. 10,000 m

Operating temperature range: -20 °C to +80 °C

Material: Outer body, End fittings: zinc plated steel; Piston rod: steel with wear-resistant coating

Operating fluid: nitrogen gas and oil

Mounting: in any position. Please adopt the mounting points determined by ACE.

End position damping length: Application-specific end position damping and extension speed.

Positive stop: External positive stop at the end of stroke provided by the customer.

Application field: hoods, shutters, machine housing, conveyor systems, folding elements, loading and lifting equipment

Note: These gas springs are tailored to the relevant application and are therefore not available ex stock.

End fittings: They are interchangeable and if necessary must be positively secured by the customer to prevent unscrewing.

On request: Special oils and other special options. Alternative accessories. Material 1.4301/1.4305, AISI 304/303 (V2A) and 1.4404/1.4571, AISI 316L/316Ti (V4A).

End Fitting

Standard Dimensions

End Fitting

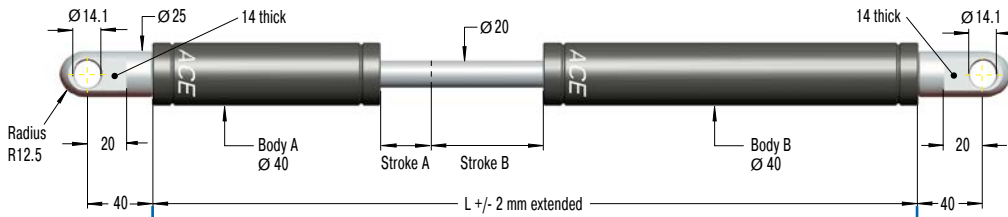
A14

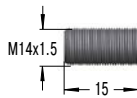
Eye A14
max. force 10,000 N

B14

Performance and Dimensions

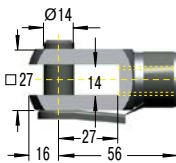
TYPES	Stroke A mm	Stroke B mm	L extended mm	Extension force max. N
GST-40-50-100	50	100	485	5,000
GST-40-50-150	50	150	585	5,000
GST-40-50-200	50	200	685	5,000
GST-40-70-250	70	250	825	5,000
GST-40-70-300	70	300	925	5,000
GST-40-70-350	70	350	1,025	5,000
GST-40-70-400	70	400	1,125	5,000

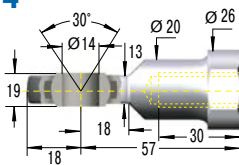
Stud Thread B14
D14

Clevis Fork D14
max. force 10,000 N

E14

Swivel Eye E14
max. force 10,000 N

Ordering Example

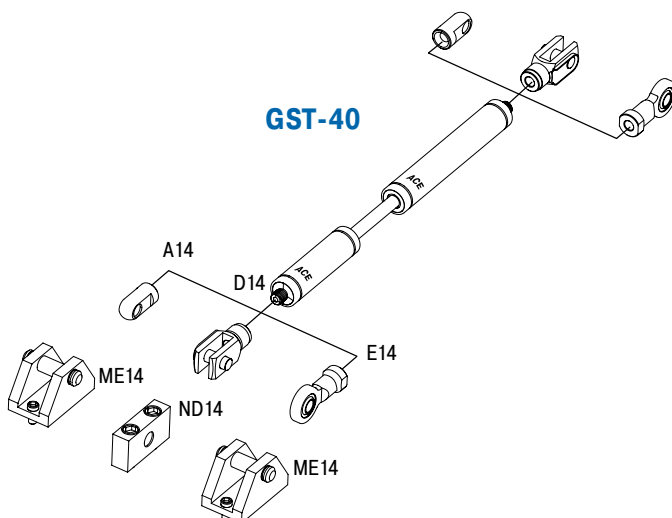
GST-40-50-150-AD-900N-2500N

Type (Tandem Gas Spring) _____
 Body Ø (40 mm) _____
 Stroke A (50 mm) _____
 Stroke B (150 mm) _____
 Body A End Fitting, A14 _____
 Body B End Fitting, D14 _____
 Nominal Force Body A, 900 N _____
 Nominal Force Body B, 2500 N _____

Mounting accessories see from page 200.

Technical Data

Extension force: 300 N to 5,000 N

Progression: according to calculation relating to your application

Operating temperature range: -20 °C to +80 °C

Material: Outer body, End fittings: zinc plated steel; Piston rod: steel with wear-resistant coating

Mounting: in any position. Please adopt the mounting points determined by ACE.

End position damping length: Application-specific end position damping and extension speed.

Positive stop: External positive stop at the end of stroke provided by the customer.

Note: These gas springs are tailored to the relevant application and are therefore not available ex stock.

End fittings: They are interchangeable and if necessary must be positively secured by the customer to prevent unscrewing.

Application Examples

GS-12

Safe opening and closing

ACE industrial gas springs (push type) protect samples in an incubator, which is used for chemical and biochemical applications. The plexiglass hood, under which may be found valuable laboratory goods, is securely held open by two maintenance-free, ready-to-install ACE industrial gas springs (push type) of the type GS-12-60-AA-X. With an end-position damping of 5 mm and an extension force of 10 to 180 N, they help to handle the forces generated. The hood is always easily opened and remains in this position. It also remains securely shut when the incubator is in operation.



Very small ACE industrial gas springs (push type) enable careful opening and closing movements of a mini-incubator hood, under which may be found laboratory products

GFL Gesellschaft für Labortechnik mbH, 30938 Burgwedel, Germany

GS-19

Doors open and close safely

ACE industrial gas springs make opening and closing doors of rescue helicopters easier. The maintenance-free, sealed systems are installed in the access doors of helicopters of the type EC 135. There, they allow the crew to enter or exit the helicopter quickly, thus contributing to enhanced safety. The GS-19-300-CC gas springs provide a defined retraction speed and secure engagement of the door lock. The integrated end position damper allows gentle closing of the door and saves wear and tear on the valuable, lightweight material.

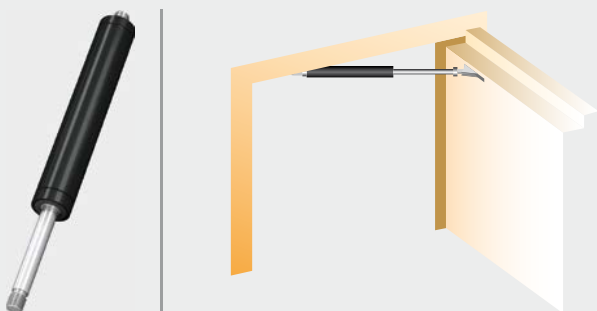

Industrial gas springs: For safe entry and exit

GS-22-VA

Made-to-measure stainless steel gas springs

A special hygiene and toilet chair, designed for children and young people with disabilities, must be firmly lockable in the sit and tilt positions. The practical aid thereby provided for relatives and carers can be attributed to two lockable ACE industrial gas springs (push type) which were especially developed and manufactured for this application and operate on the basis of the so-called tilt-in-space function. This allows the chair to be tilted forwards and backwards and provides significantly more convenience for users and patients. In order to meet all hygiene requirements, the gas springs are constructed in stainless steel.

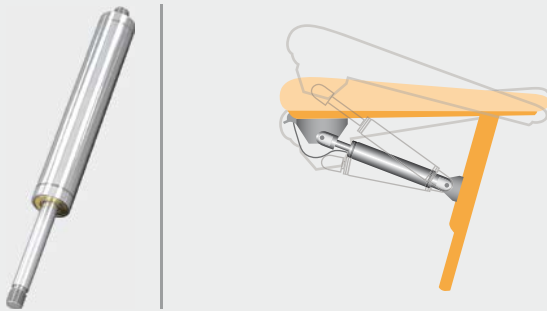

With inclination angles of 15 degrees to the front and rear, the ACE stainless steel gas springs facilitate the work of nurses
Rifton Equipment, Rifton, New York 12471, USA

GST-40

Tandemly-operated large flaps securely under control

Underground distribution systems are visually advantageous. To facilitate their servicing, the heavy covers of the often large supply systems are brought back to the surface with the help of ACE industrial tandem gas springs (push type). This is quite easily achieved thanks to the use of two pressure pipes, the result of which is two different force ranges. This means fitters must not endure laborious bending and a downward passage into the system of channels. In addition to these advantages, the springs benefit from their long service life and their capacity to be used, as stainless steel variants, in even the most hygienically-sensitive areas.



ACE industrial tandem gas springs (push type) enable easy maintenance of supply boxes by making the heavy flaps easier to operate
Langmatz GmbH, 82467 Garmisch-Partenkirchen, Germany

Industrial Gas Springs – Pull Type

Takes over when things get too tight for gas pressure springs

If ACE gas push type springs cannot be used due to a lack of space, ACE's industrial gas pull type springs come into their own. The compact assistants with body diameters of 15 mm to 40 mm are effective in the direction of traction and work in the opposite way to the principle of gas push type springs.

This means that the gas pressure in the cylinder draws the piston rod in and, when closing a flap for example, supports the manual force with the pressure springs. ACE's gas pull type springs are also self-contained, maintenance-free machine elements and equipped with a standard valve to individually regulate the gas pressure, whereby they cover forces between 30 N and 5,000 N. Any installation position, extensive DIN standardised accessories and various models enable universal use.

Compact design

Individual filling valve technology

Calculation program for specific design

Universally applicable

Delivery time within 24 hours



Function of a Gas Spring – Pull Type

Gas pull type springs work based on the reverse principle of a gas push type spring. They are also individually filled according to customer request to a certain pressure (traction force F_1). However, the piston rod here is pulled inwards by the gas pressure in the cylinder. The higher the pressure, the greater the traction force.

The piston ring surface between the piston rod and the inner tube is decisive for the function. When the piston rod pulls out, the nitrogen from the piston is compressed in the inner tube. The force increase (progression) of the gas spring is due to the rising pressure. The force increase is almost linear.

Free calculation service see page 172!

Calculation Principles

Force-Stroke Characteristics of Traction Gas Spring (Pull Type)

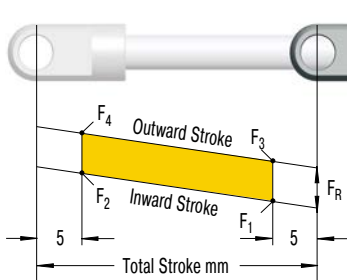

F_1 = nominal force at 20 °C (this is the pressure figure normally used when specifying the gas spring)
 F_2 = force in the complete extended position
 When extending the piston rod, there is an additional friction force caused by the contact pressure of the seals (this only occurs during the extension stroke):
 F_3 = force at the beginning of the extension stroke
 F_4 = force at the end of the extension stroke

Gas Springs (Pull Type)

TYPES	Progression approx. %	¹ Friction F_R approx. in N
GZ-15	12 - 22 ²	55 - 140
GZ-19	21 - 28 ²	20 - 40
GZ-28	28 - 30 ²	100 - 200
GZ-40	43 - 45 ²	

¹ Depending on the filling force
² Depending on the stroke

Progression: (the slope of the force line in the diagram above) is due to the reduction of the internal gas volume as the piston rod moves from its initial position to its fully stroked position. The approx. progression values given above for standard springs can be altered on request.

Effect of temperature: The nominal F_1 figure is given at 20 °C. An increase of 10 °C will increase force by 3.4 %.

Filling tolerances: -20 N to +40 N or 5 % to 7 %. Depending on size and traction force the tolerances can differ.

Industrial Gas Springs – Pull Type



GZ-15 to GZ-40

Valve Technology
Very low progression rate
 Hoods, Shutters, Machine housing, Conveyor systems

Page 160

GZ-15-V4A to GZ-40-VA

Valve Technology, Stainless Steel
Very low progression rate with FDA approval
 Hoods, Shutters, Machine housing, Conveyor systems

Page 166

GZ-15 to GZ-40

Very low progression rate

Valve Technology

Traction force range 40 N to 5,000 N

Stroke 20 mm to 650 mm

The solution to a lack of space: If standard push type gas springs cannot be used due to a lack of space, ACE's industrial pull type gas springs come into their own. They work in the opposite way to standard push type gas springs. The piston rod is retracted when the cylinder is unloaded. The gas pressure in the cylinder draws the piston rod in.

ACE pull type gas springs offer the maximum service life thanks to the solid chrome-plated piston rod and an integrated sliding bearing. The maintenance-free and ready-to-install products are available in body diameters of 15 to 40 mm as well as forces from 40 to 5,000 N and are available from stock with valve and large selection of accessories. The traction force can be subsequently adjusted using the valve.

Gas traction springs from ACE are used in industrial applications, especially in mechanical engineering and in medical technology as well as in the electronics and furniture industries.

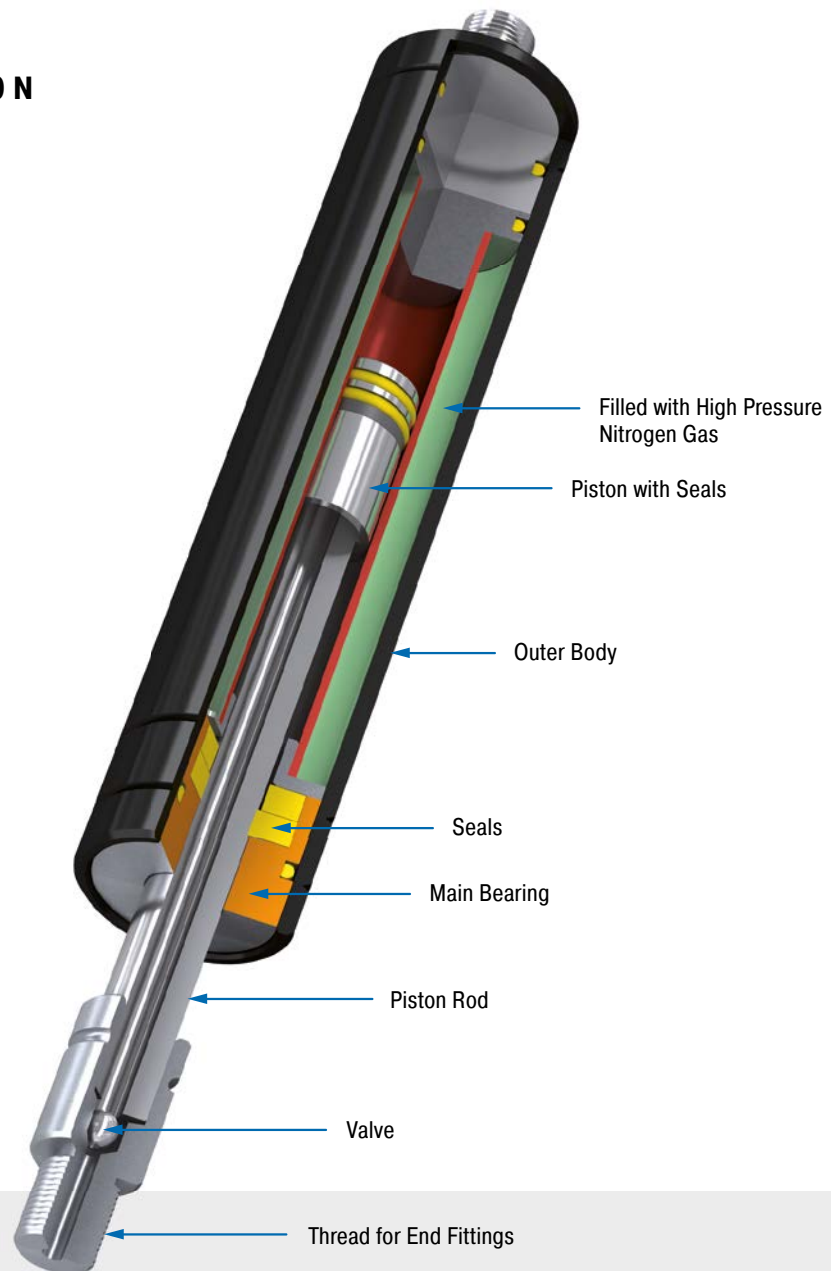

Technical Data

Traction force: 40 N to 5,000 N

Piston rod diameter: Ø 4 mm to Ø 28 mm

Progression: approx. 12 % to 45 %

Lifetime: Approx. 2,000 m

Operating temperature range: -20 °C to +80 °C

Material: Outer body, End fittings: zinc plated steel; Piston rod: steel or stainless steel with wear-resistant coating

Operating fluid: nitrogen gas

Mounting: with piston rod upwards

End position damping length: Without damping. For end position damping use damping material (e.g. TUBUS or SLAB).

Positive stop: External positive stop at the end of stroke provided by the customer.

Application field: hoods, shutters, machine housing, conveyor systems, control boxes, furniture industry, shipbuilding, assembly stations, vehicle technology, folding elements

End fittings: They are interchangeable and if necessary must be positively secured by the customer to prevent unscrewing.

On request: Special oils and other special options. Alternative accessories. Traction gas springs with end position damping also available on request.

Valve Technology, Traction force 50 N to 150 N (extended up to 183 N)

End Fitting
Standard Dimensions
End Fitting

Performance and Dimensions

TYPES	Stroke mm	L retracted mm	Traction force max. N
GZ-15-20	20	87	150
GZ-15-40	40	107	150
GZ-15-50	50	117	150
GZ-15-60	60	127	150
GZ-15-80	80	147	150
GZ-15-100	100	167	150
GZ-15-120	120	187	150
GZ-15-150	150	217	150

Ordering Example

GZ-15-150-AC-150

- Type (Pull Type)
- Body Ø (15.6 mm)
- Stroke (150 mm)
- Piston Rod End Fitting A3,5
- Body End Fitting C3,5
- Traction Force F_1 150 N

End Fitting Options:

- A3,5:** Eye A3,5 max. force 370 N
- B3,5:** Stud Thread B3,5
- C3,5:** Angle Ball Joint C3,5 max. force 370 N
- D3,5:** Clevis Fork D3,5 max. force 370 N
- E3,5:** Swivel Eye E3,5 max. force 370 N
- G3,5:** Ball Socket G3,5 max. force 370 N
- Adjuster Knob DE-GAS-3,5** See page 175.

Mounting accessories see from page 200.

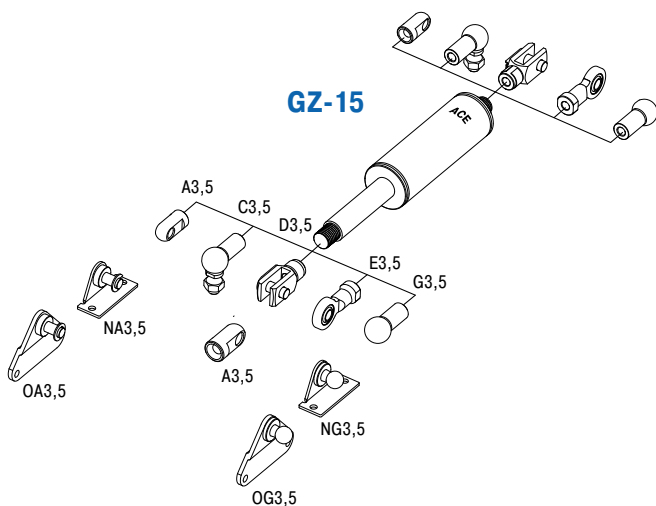
Technical Data
Traction force: 50 N to 150 N (extended up to 183 N)

Progression: Approx. 12 % to 22 %

Lifetime: Approx. 2,000 m

Operating temperature range: -20 °C to +80 °C

Material: Outer body, End fittings: zinc plated steel; Piston rod: stainless steel (1.4301/1.4305, AISI 304/303)

Mounting: with piston rod upwards

End position damping length: Without damping. For end position damping use damping material (e.g. TUBUS or SLAB).

Positive stop: External positive stop at the end of stroke provided by the customer.

End fittings: They are interchangeable and if necessary must be positively secured by the customer to prevent unscrewing.

Valve Technology, Traction force 40 N to 350 N (extended up to 448 N)

End Fitting

Standard Dimensions

End Fitting

Performance and Dimensions

TYPES	Stroke mm	L retracted mm	Traction force max. N
GZ-19-30	30	112	350
GZ-19-50	50	132	350
GZ-19-100	100	182	350
GZ-19-150	150	232	350
GZ-19-200	200	282	350
GZ-19-250	250	332	350

Ordering Example

GZ-19-150-AC-250

- Type (Pull Type)
- Body Ø (19 mm)
- Stroke (150 mm)
- Piston Rod End Fitting A8
- Body End Fitting C8
- Traction Force F_1 250 N

End Fitting Options:

- A8 Eye:** max. force 3,000 N
- B8 Stud Thread:**
- C8 Angle Ball Joint:** max. force 1,200 N
- D8 Clevis Fork:** max. force 3,000 N
- E8 Swivel Eye:** max. force 3,000 N
- G8 Ball Socket:** max. force 1,200 N

Rod Shroud W8-19: L = Stroke + 30

Adjuster Knob DE-GAS-8: See page 175.

Mounting accessories see from page 200.

Adjuster Knob DE-GAS-8
See page 175.

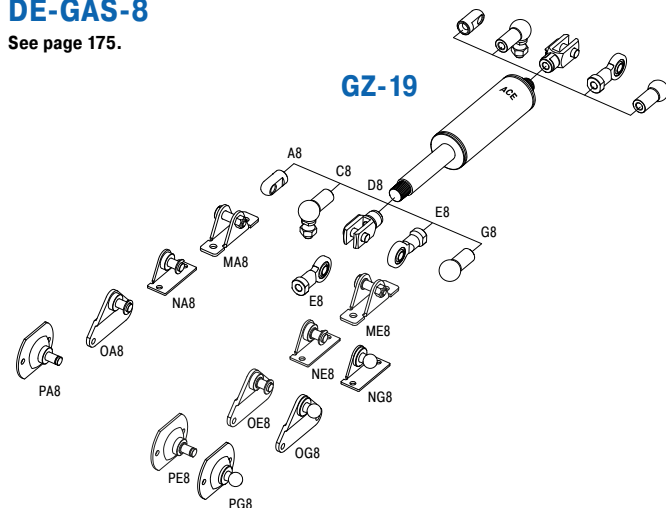

Technical Data

- Traction force:** 40 N to 350 N (extended up to 448 N)
- Progression:** Approx. 21 % to 28 %
- Lifetime:** Approx. 2,000 m
- Operating temperature range:** -20 °C to +80 °C
- Material:** Outer body, End fittings: zinc plated steel; Piston rod: steel with wear-resistant coating
- Mounting:** with piston rod upwards
- End position damping length:** Without damping. For end position damping use damping material (e.g. TUBUS or SLAB).
- Positive stop:** External positive stop at the end of stroke provided by the customer.
- End fittings:** They are interchangeable and if necessary must be positively secured by the customer to prevent unscrewing.

Valve Technology, Traction force 150 N to 1,200 N (extended up to 1,560 N)

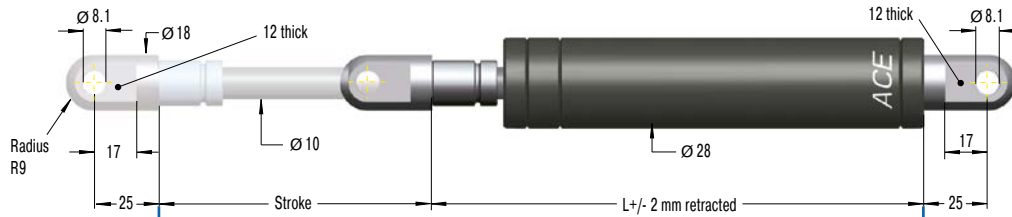
End Fitting
Standard Dimensions
End Fitting
A10

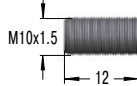
Eye A10
max. force 10,000 N

B10

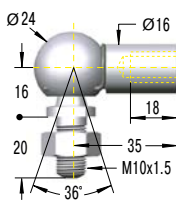
Performance and Dimensions

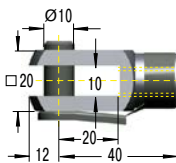
TYPES	Stroke mm	L retracted mm	Traction force max. N
GZ-28-30	30	130	1,200
GZ-28-50	50	150	1,200
GZ-28-100	100	200	1,200
GZ-28-150	150	250	1,200
GZ-28-200	200	300	1,200
GZ-28-250	250	350	1,200
GZ-28-300	300	400	1,200
GZ-28-350	350	450	1,200
GZ-28-400	400	500	1,200
GZ-28-450	450	550	1,200
GZ-28-500	500	600	1,200
GZ-28-550	550	650	1,200
GZ-28-600	600	700	1,200
GZ-28-650	650	750	1,200

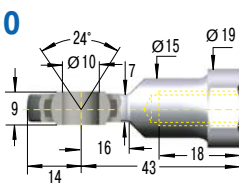
Stud Thread B10
C10

Angle Ball Joint C10
max. force 1,800 N

D10

Clevis Fork D10
max. force 10,000 N

E10

Swivel Eye E10
max. force 10,000 N

Ordering Example

Type (Pull Type) _____
 Body Ø (28 mm) _____
 Stroke (150 mm) _____
 Piston Rod End Fitting E10 _____
 Body End Fitting E10 _____
 Traction Force F_1 800 N _____

GZ-28-150-EE-800

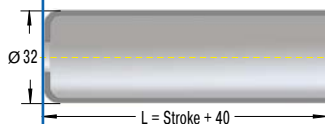
Mounting accessories see from page 200.

Rod Shroud W10-28

**Adjuster Knob
DE-GAS-10**

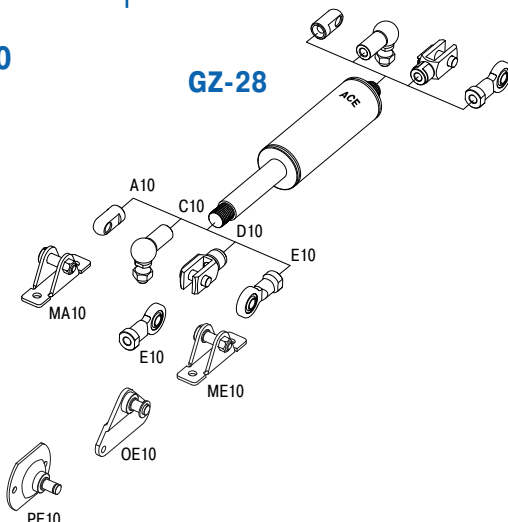
See page 175.

GZ-28

Technical Data
Traction force: 150 N to 1,200 N (extended up to 1,560 N)

Progression: Approx. 28 % to 30 %

Lifetime: Approx. 2,000 m

Operating temperature range: -20 °C to +80 °C

Material: Outer body, End fittings: zinc plated steel; Piston rod: steel with wear-resistant coating

Mounting: with piston rod upwards

End position damping length: Without damping. For end position damping use damping material (e.g. TUBUS or SLAB).

Positive stop: External positive stop at the end of stroke provided by the customer.

End fittings: They are interchangeable and if necessary must be positively secured by the customer to prevent unscrewing.

Valve Technology, Traction force 500 N to 5,000 N (extended up to 7,250 N)

End Fitting

Standard Dimensions

End Fitting

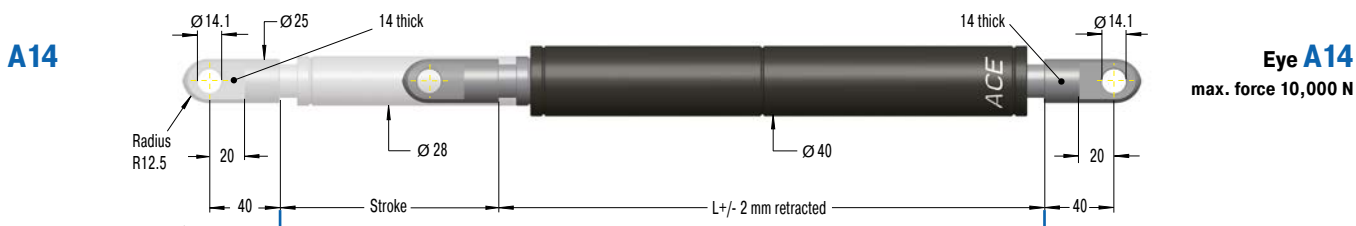

B14

Stud Thread B14

C14

Angle Ball Joint C14

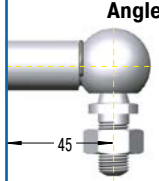
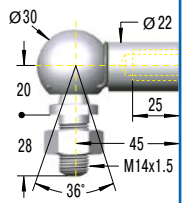

D14

Clevis Fork D14

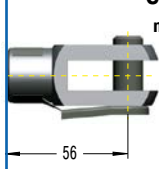
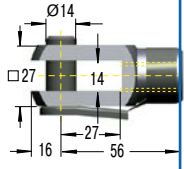

E14

Swivel Eye E14

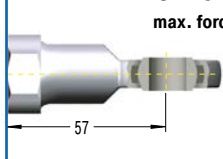
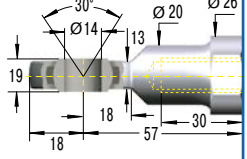

Performance and Dimensions

TYPES	Stroke mm	L retracted mm	Traction force max. N
GZ-40-100	100	250	5,000
GZ-40-150	150	325	5,000
GZ-40-200	200	400	5,000
GZ-40-250	250	475	5,000
GZ-40-300	300	550	5,000
GZ-40-400	400	700	5,000
GZ-40-500	500	850	5,000
GZ-40-600	600	1,000	5,000

Ordering Example

GZ-40-150-EE-800

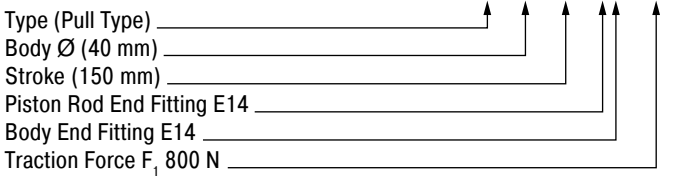

Mounting accessories see from page 200.

Rod Shroud W14-40

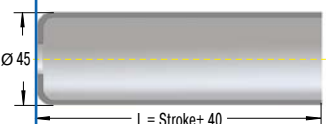

Adjuster Knob DE-GAS-14
See page 175.

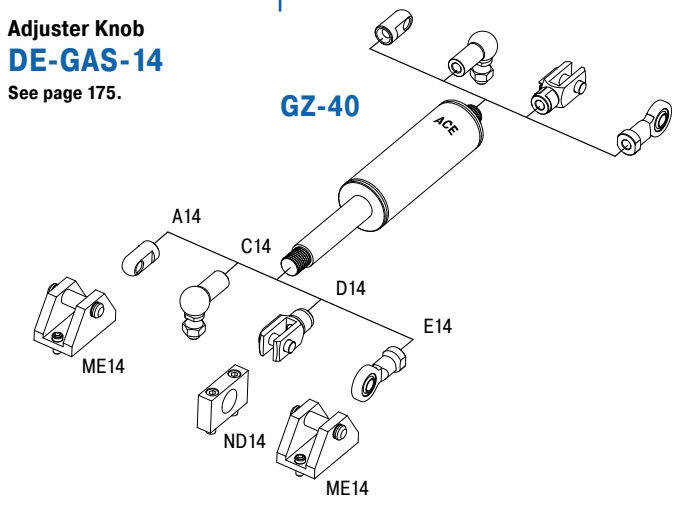

Technical Data

- Traction force:** 500 N to 5,000 N (extended up to 7,250 N)
- Progression:** Approx. 43 % to 45 %
- Lifetime:** Approx. 2,000 m
- Operating temperature range:** -20 °C to +80 °C
- Material:** Outer body, End fittings: zinc plated steel; Piston rod: steel with wear-resistant coating
- Mounting:** with piston rod upwards
- End position damping length:** Without damping. For end position damping use damping material (e.g. TUBUS or SLAB).
- Positive stop:** External positive stop at the end of stroke provided by the customer.
- End fittings:** They are interchangeable and if necessary must be positively secured by the customer to prevent unscrewing.

Issue 07.2017 – Specifications subject to change

ACE Digital Tools



For more information
about the calculation
service see page 172!

Print catalogue? Everyone can.

ACE offers more:

- ▶ Downloads: Product information in many languages
- ▶ PC calculation software & online calculation service
- ▶ Extensive CAD component libraries
- ▶ ACE-YouTube-Channel with video tips
- ▶ VibroChecker – awarded free iPhone App

All information on our Website: www.ace-ace.com

GZ-15-V4A to GZ-40-VA

Very low progression rate with FDA approval

Valve Technology, Stainless Steel

Traction force range 40 N to 5,000 N

Stroke 20 mm to 600 mm

Brilliant performance when things become tight: For specific use e.g. in tough surroundings or small spaces, the broad spectrum of ACE industrial pull type gas springs made of stainless steel with body diameters from 15 mm to 40 mm supplements the comprehensive programme of the ACE industrial pull type gas springs with valves.

This high quality design is rust free and is more robust against environmental impact compared with standard gas pull type springs. These stainless steel gas springs are also optically appealing, very durable and available, upon request, in many stroke lengths and are also possible in many traction forces in combination with the suitable stainless steel accessories.

ACE industrial push type springs made of stainless steel are used in industries such as the chemical and food industry, in automobiles, plant engineering and shipbuilding and also in medical, military, environmental and water supply technology.

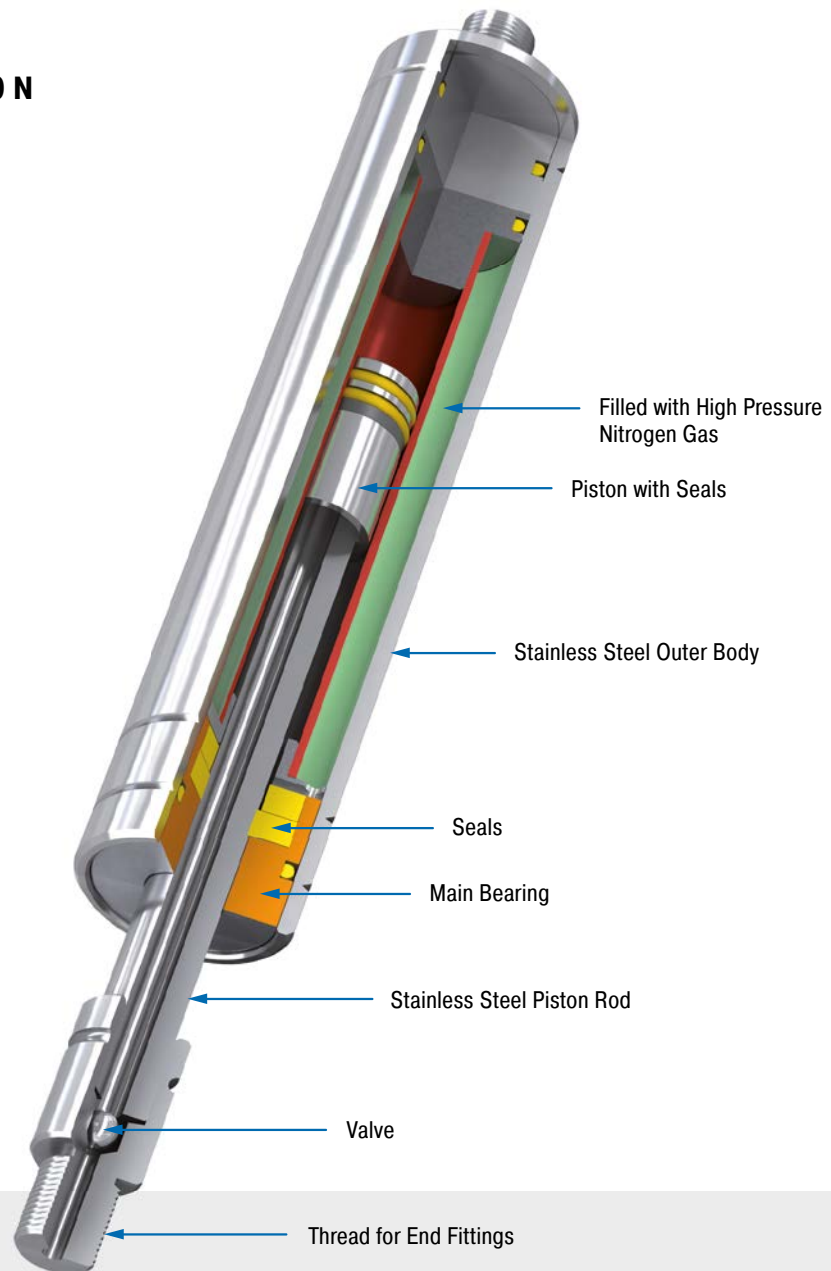

Technical Data

Traction force: 40 N to 5,000 N

Piston rod diameter: Ø 4 mm to Ø 28 mm

Progression: approx. 11 % to 45 %

Lifetime: Approx. 2,000 m

Operating temperature range: -20 °C to +80 °C

Material: Outer body, Piston rod, End fittings: stainless steel (1.4301/1.4305, AISI 304/303 and 1.4404/1.4571, AISI 316L/316Ti)

Operating fluid: nitrogen gas

Mounting: with piston rod upwards

End position damping length: Without damping. For end position damping use damping material (e.g. TUBUS or SLAB).

Positive stop: External positive stop in the pulling direction provided by the customer.

Application field: hoods, shutters, machine housing, conveyor systems, control boxes, furniture industry, shipbuilding, food industry, pharmaceutical industry, folding elements

End fittings: They are interchangeable and if necessary must be positively secured by the customer to prevent unscrewing.

On request: Special oils and other special options. Alternative accessories. Traction gas springs with end position damping also available on request. Other traction gas springs material 1.4404/1.4571, AISI 316L/316Ti (V4A) available on request.

Valve Technology, Stainless Steel, Traction force 50 N to 150 N (extended up to 182 N)

End Fitting
Standard Dimensions
End Fitting

B3,5

A3,5-V4A

C3,5-V4A

D3,5-V4A

G3,5-V4A

Performance and Dimensions

TYPES	Stroke mm	L retracted mm	Traction force max. N
GZ-15-20-V4A	20	87	150
GZ-15-40-V4A	40	107	150
GZ-15-50-V4A	50	117	150
GZ-15-60-V4A	60	127	150
GZ-15-80-V4A	80	147	150
GZ-15-100-V4A	100	167	150
GZ-15-120-V4A	120	187	150
GZ-15-150-V4A	150	217	150

Ordering Example

GZ-15-150-AC-150-V4A

Type (Pull Type) _____

Body Ø (15.6 mm) _____

Stroke (150 mm) _____

Piston Rod End Fitting A3,5-V4A _____

Body End Fitting C3,5-V4A _____

Traction Force F₁ 150 N _____

Material (1.4404/1.4571, AISI 316L/316Ti, V4A) _____

Stud Thread B3,5

Eye A3,5-V4A
max. force 370 N

Angle Ball Joint C3,5-V4A
max. force 370 N

Clevis Fork D3,5-V4A
max. force 370 N

Ball Socket G3,5-V4A
max. force 370 N

Adjuster Knob DE-GAS-3,5
See page 175.

Mounting accessories see from page 208.

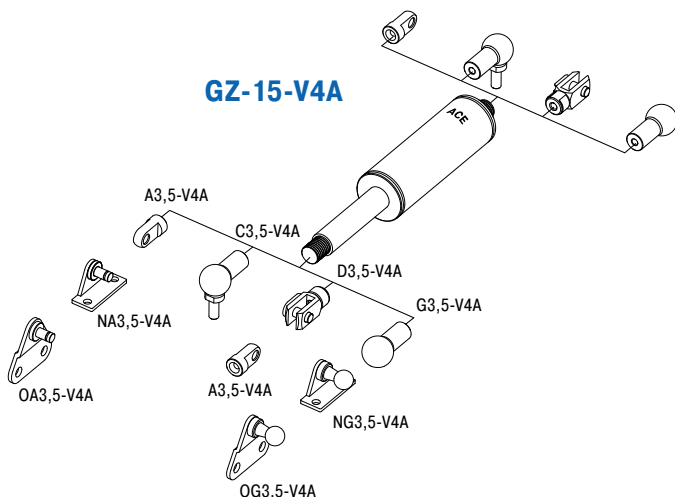
Technical Data
Traction force: 50 N to 150 N (extended up to 182 N)

Progression: Approx. 11 % to 21 %

Lifetime: Approx. 2,000 m

Operating temperature range: -20 °C to +80 °C

Material: Outer body, Piston rod, End fittings: stainless steel (1.4404/1.4571, AISI 316L/316Ti)

Mounting: with piston rod upwards

End position damping length: Without damping. For end position damping use damping material (e.g. TUBUS or SLAB).

Positive stop: External positive stop in the pulling direction provided by the customer.

End fittings: They are interchangeable and if necessary must be positively secured by the customer to prevent unscrewing.

Valve Technology, Stainless Steel, Traction force 40 N to 350 N (extended up to 448 N)

End Fitting

Standard Dimensions

End Fitting

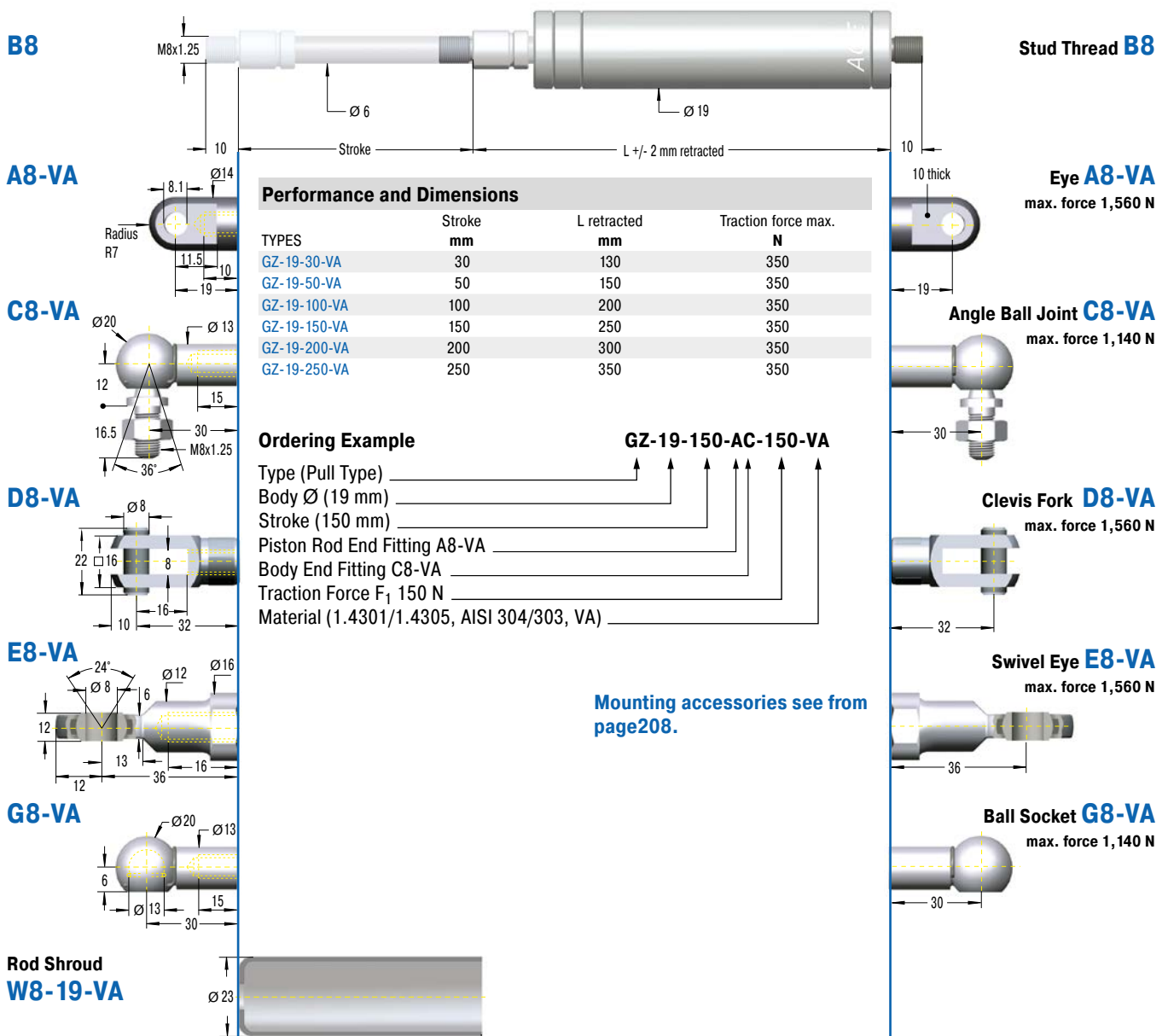

Performance and Dimensions

TYPES	Stroke mm	L retracted mm	Traction force max. N
GZ-19-30-VA	30	130	350
GZ-19-50-VA	50	150	350
GZ-19-100-VA	100	200	350
GZ-19-150-VA	150	250	350
GZ-19-200-VA	200	300	350
GZ-19-250-VA	250	350	350

Ordering Example

GZ-19-150-AC-150-VA

Type (Pull Type) _____
 Body Ø (19 mm) _____
 Stroke (150 mm) _____
 Piston Rod End Fitting A8-VA _____
 Body End Fitting C8-VA _____
 Traction Force F₁ 150 N _____
 Material (1.4301/1.4305, AISI 304/303, VA) _____

Mounting accessories see from page 208.

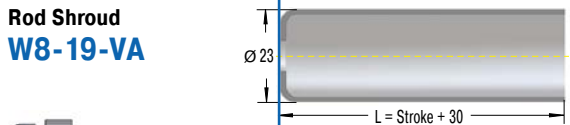

Adjuster Knob DE-GAS-8
See page 175.

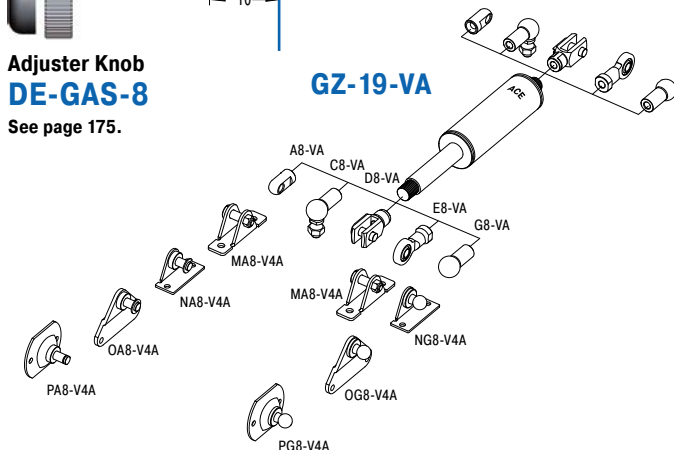

Technical Data

- Traction force:** 40 N to 350 N (extended up to 448 N)
- Progression:** Approx. 23 % to 28 %
- Lifetime:** Approx. 2,000 m
- Operating temperature range:** -20 °C to +80 °C
- Material:** Outer body, Piston rod, End fittings: stainless steel (1.4301/1.4305, AISI 304/303)
- Mounting:** with piston rod upwards
- End position damping length:** Without damping. For end position damping use damping material (e.g. TUBUS or SLAB).
- Positive stop:** External positive stop in the pulling direction provided by the customer.
- End fittings:** They are interchangeable and if necessary must be positively secured by the customer to prevent unscrewing.

Issue 07.2017 – Specifications subject to change

Valve Technology, Stainless Steel, Traction force 150 N to 1,200 N (extended up to 1,560 N)

End Fitting

Standard Dimensions

End Fitting

B10 Stud Thread **B10**

A10-VA Eye **A10-VA**
max. force 3,800 N

C10-VA Angle Ball Joint **C10-VA**
max. force 1,750 N

D10-VA Clevis Fork **D10-VA**
max. force 3,800 N

E10-VA Swivel Eye **E10-VA**
max. force 3,800 N

Rod Shroud W10-28-VA
L = Stroke + 40

Adjuster Knob DE-GAS-10
See page 175.

Performance and Dimensions

TYPES	Stroke mm	L retracted mm	Traction force max. N
GZ-28-50-VA	50	165	1,200
GZ-28-100-VA	100	215	1,200
GZ-28-150-VA	150	265	1,200
GZ-28-200-VA	200	315	1,200
GZ-28-250-VA	250	365	1,200
GZ-28-300-VA	300	415	1,200
GZ-28-350-VA	350	465	1,200
GZ-28-400-VA	400	515	1,200
GZ-28-450-VA	450	565	1,200
GZ-28-500-VA	500	615	1,200
GZ-28-550-VA	550	665	1,200
GZ-28-600-VA	600	715	1,200

Ordering Example

GZ-28-150-EE-800-VA

Type (Pull Type) _____
 Body Ø (28 mm) _____
 Stroke (150 mm) _____
 Piston Rod End Fitting E10-VA _____
 Body End Fitting E10-VA _____
 Traction Force F_1 800 N _____
 Material (1.4301/1.4305, AISI 304/303, VA) _____

Mounting accessories see from page 208.

GZ-28-VA

Technical Data

Traction force: 150 N to 1,200 N (extended up to 1,560 N)

Progression: Approx. 29 % to 30 %

Lifetime: Approx. 2,000 m

Operating temperature range: -20 °C to +80 °C

Material: Outer body, Piston rod, End fittings: stainless steel (1.4301/1.4305, AISI 304/303)

Mounting: with piston rod upwards

End position damping length: Without damping. For end position damping use damping material (e.g. TUBUS or SLAB).

Positive stop: External positive stop in the pulling direction provided by the customer.

End fittings: They are interchangeable and if necessary must be positively secured by the customer to prevent unscrewing.

End Fitting

Standard Dimensions

End Fitting

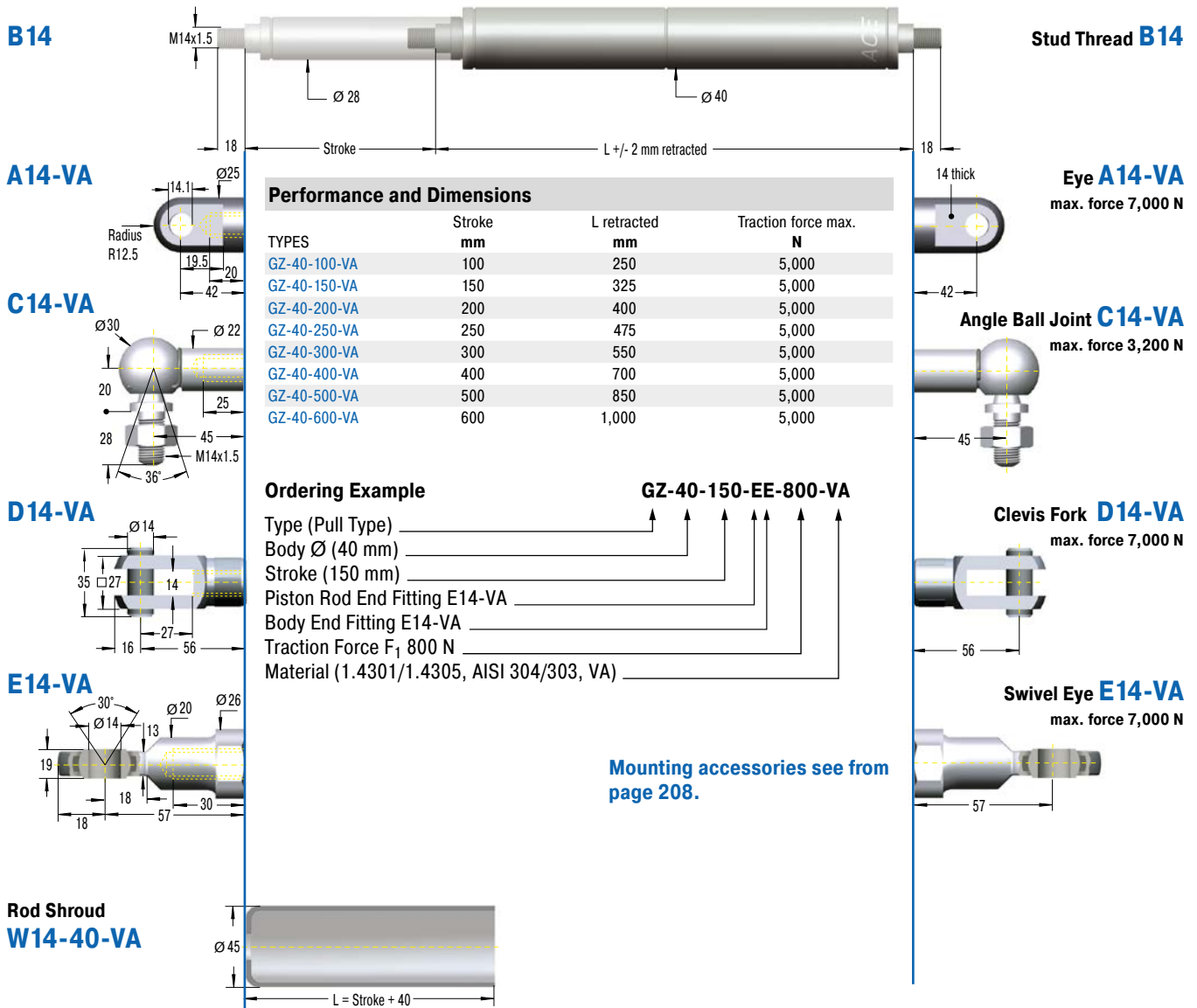

Performance and Dimensions

TYPES	Stroke mm	L retracted mm	Traction force max. N
GZ-40-100-VA	100	250	5,000
GZ-40-150-VA	150	325	5,000
GZ-40-200-VA	200	400	5,000
GZ-40-250-VA	250	475	5,000
GZ-40-300-VA	300	550	5,000
GZ-40-400-VA	400	700	5,000
GZ-40-500-VA	500	850	5,000
GZ-40-600-VA	600	1,000	5,000

Ordering Example

GZ-40-150-EE-800-VA

Type (Pull Type) _____

Body Ø (40 mm) _____

Stroke (150 mm) _____

Piston Rod End Fitting E14-VA _____

Body End Fitting E14-VA _____

Traction Force F_1 800 N _____

Material (1.4301/1.4305, AISI 304/303, VA) _____

Mounting accessories see from page 208.

Adjuster Knob **DE-GAS-14**

See page 175.

GZ-40-VA

Technical Data

Traction force: 500 N to 5,000 N (extended up to 7,250 N)

Progression: Approx. 43 % to 45 %

Lifetime: Approx. 2,000 m

Operating temperature range: -20 °C to +80 °C

Material: Outer body, Piston rod, End fittings: stainless steel (1.4301/1.4305, AISI 304/303)

Mounting: with piston rod upwards

End position damping length: Without damping. For end position damping use damping material (e.g. TUBUS or SLAB).

Positive stop: External positive stop in the pulling direction provided by the customer.

End fittings: They are interchangeable and if necessary must be positively secured by the customer to prevent unscrewing.

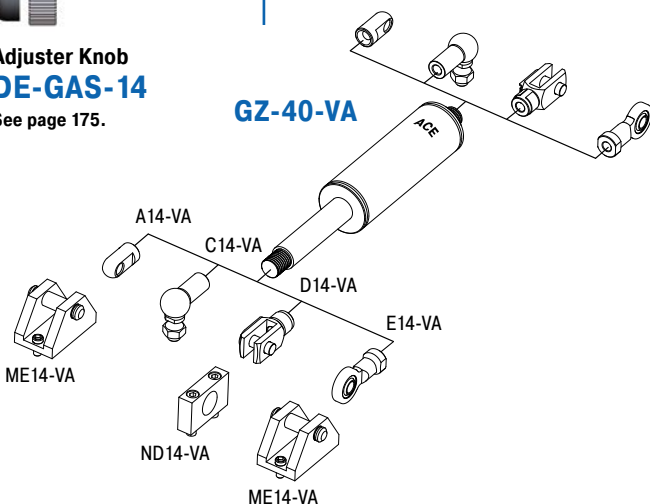

Stainless Steel Gas Springs (Pull Type), V4A

TYPES	Stroke mm	L retracted mm	Dimensions see Page
GZ-19-30-V4A	30	130	168
GZ-19-50-V4A	50	150	168
GZ-19-100-V4A	100	200	168
GZ-19-150-V4A	150	250	168
GZ-19-200-V4A	200	300	168
GZ-19-250-V4A	250	350	168
GZ-28-50-V4A	50	165	169
GZ-28-100-V4A	100	215	169
GZ-28-150-V4A	150	265	169
GZ-28-200-V4A	200	315	169
GZ-28-250-V4A	250	365	169
GZ-28-300-V4A	300	415	169
GZ-28-350-V4A	350	465	169
GZ-28-400-V4A	400	515	169
GZ-28-450-V4A	450	565	169
GZ-28-500-V4A	500	615	169
GZ-28-550-V4A	550	665	169
GZ-28-600-V4A	600	715	169
GZ-40-100-V4A	100	250	170
GZ-40-150-V4A	150	325	170
GZ-40-200-V4A	200	400	170
GZ-40-250-V4A	250	475	170
GZ-40-300-V4A	300	550	170
GZ-40-400-V4A	400	700	170
GZ-40-500-V4A	500	850	170
GZ-40-600-V4A	600	1,000	170

Stainless Steel Accessories, V4A

TYPES	Dimensions see Page
A5-V4A	210
C5-V4A	210
D5-V4A	210
E5-V4A	210
G5-V4A	210
A8-V4A	211
C8-V4A	211
D8-V4A	211
E8-V4A	211
G8-V4A	212
A10-V4A	212
C10-V4A	212
D10-V4A	212
E10-V4A	212
A14-V4A	213
C14-V4A	213
D14-V4A	213
E14-V4A	213

Free Calculation Offer for Industrial Gas Springs

With all necessary information for installation

To obtain the optimum operation with minimal hand force, the gas spring must be properly sized and the mounting points have to be optimally placed.

It is important to identify the following points:

- gas spring size
- required gas spring stroke
- mounting points on flap and frame
- extended length of the gas spring
- required extension force
- hand forces throughout the complete movement on the flap

With our free calculation service you can eliminate the time-consuming calculation and send us your details by fax or e-mail. Just complete the information shown on the following page. Please attach a sketch of your application (a simple hand sketch is sufficient) in side view. Our application engineers will determine the optimum gas springs and mounting points and calculate the ideal situation to satisfy your requirements. You will receive a quotation showing the opening and closing forces and our recommended mounting points to suit your application.

NEW!
Also try our
Online Calculation Service:
www.ace-ace.com

Example of a Calculation Offer

Input data		Identification data	
Start angle	αM : 270 °	Temperature	: 20 °C
Open angle	α : 105 °	Progression	: 42 %
Rd. ctr.grvty.	RM: 410 mm	Friction	: 30 N
Mass	m: 12 kg	Ext. length	: 504 mm
No. gas springs	n: 2		
Radius handfor	RR: 820 mm		

Required user hand-forces

F1-F2/F3-F4=Hand forces for opening/closing
Angle [°] F1-F2 [N] F3-F4 [N] Length [mm]

270	-13	-14	311
293	37	42	323
317	59	68	363
340	53	63	418
363	34	44	477
375	25	34	504

F1-F4 positive requires clockwise hand force
F1-F4 negative requires counter-clockwise hand force

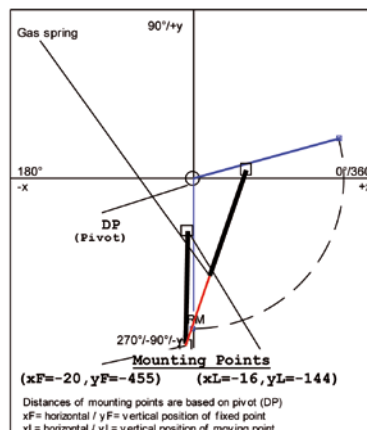

Input Data

Gas Spring Push type Gas Spring Pull type

Gas spring fixing points

The fixed point of the frame and the moving point of the flap are critical for the optimum operation.

Therefore please attach a sketch of your application!
(A few lines with their dimensions are sufficient)

Moving mass* m _____ kg
 Number of gas springs in parallel* n _____ pcs
 Number of movements* _____ /day
 Ambient temperature T _____ °C

If not shown by the sketch:

Radius of centre of gravity R_M _____ mm
 Radius of hand force R_H _____ mm
 Starting angle α_M _____ °
 Opening angle α _____ °

* Compulsory information

Desired Mounting Fittings

End Fitting

- | | | |
|----------------------------|--------------------------------|----------------------------|
| <input type="checkbox"/> A | | <input type="checkbox"/> A |
| <input type="checkbox"/> B | B Stud Thread
 | <input type="checkbox"/> B |
| <input type="checkbox"/> C | C Angle Ball Joint
 | <input type="checkbox"/> C |
| <input type="checkbox"/> D | D Clevis Fork
 | <input type="checkbox"/> D |
| <input type="checkbox"/> E | E Swivel Eye
 | <input type="checkbox"/> E |
| <input type="checkbox"/> F | F Inline Ball Joint
 | <input type="checkbox"/> F |
| <input type="checkbox"/> G | G Ball Socket
 | <input type="checkbox"/> G |

The end fittings are interchangeable

e.g. -CE: C = Angle Ball Joint, E = Swivel Eye

Hood

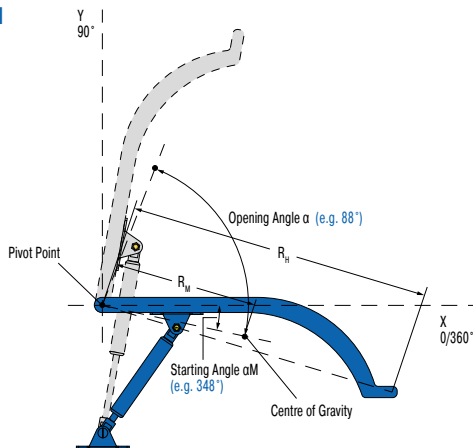

Flap

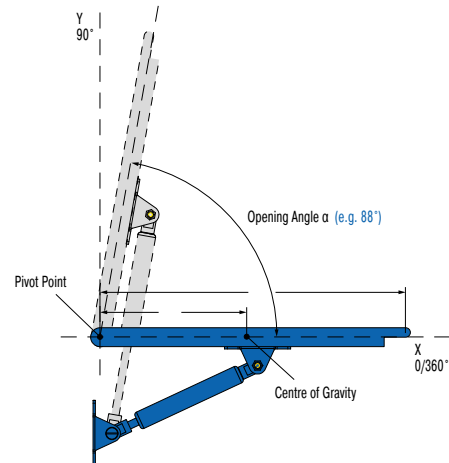

Please send us a sketch with dimensions of your application!
Without this sketch we won't be able to calculate.

Comments	
Requirement per year	
Machine type / reference	

Sender

Company		Dept.	
Address		Name	
ZIP / City		Telephone	
Internet		E-Mail	

Please copy, complete and fax with attached sketch to: +49 (0)2173 - 9226-89

Mounting and Safety Instructions

Filling

Gas springs are filled with pure nitrogen gas. Nitrogen is an inert gas that does not burn or explode and is not poisonous. The internal pressure of gas springs can be up to 300 bar. Do not attempt to open or modify them!

Gas springs are maintenance-free!

ACE gas springs will operate in surrounding temperatures from -20 °C to +80 °C.

We can equip our springs with special seals to withstand temperatures as low as -45 °C or as high as +200 °C.

Gas springs should not be placed over heat or in open fire!

ACE gas springs can be stored in any position. Pressure lost through long storage is not to be expected. There are no known negative values, but there may be a sticking effect the first time you compress a spring. This may require a higher initial force to operate the gas spring for the first time (initial breakaway force).

Mounting

Gas springs should be installed with the piston rod downwards. This position ensures best damping quality. ACE gas springs include an integrated grease chamber which allows for alternative mounting opportunities.

The tolerance for the installation length is generally deemed to be ± 2 mm. If very high demands are placed on durability and stability, please avoid the combination of small diameter + long stroke + high force.

The filling tolerance is -20 N to 40 N or 5 % to 7 %. Depending on size and extension force the tolerances can differ.

Life Time

Generally, ACE gas springs are tested to 70,000 to 100,000 complete strokes. This is equivalent to the seal lifetime (depending on model size) to a distance travelled of 10 km (lifetime of traction gas springs approx. 2 km). During these tests the gas spring must not lose more than 5 % of its pressure. Depending upon the application and operating environment, the service life of these gas springs may be much longer. In practise 500,000 strokes or more have been achieved on some applications.

Disposal/Recycling

Please ask for our disposal recommendations.

Warnings and Liability

All gas springs are marked with the part number, the production date and a warning sign "Do not open high pressure".

We are not responsible for any damages of any kind that arises due to goods that are not marked accordingly.

Valve Actuation with ACE DE-GAS

Simple, safe and reliable

De-gassing for controlled force reduction on valve gas springs

The reduction is made by screwing the DE-Gas on the male screwed end of the gas spring. The drain process is possible through light actuation of the push button. If too much nitrogen is discharged, the gas spring can be refilled by ACE.

Adjustment

1. Hold gas spring valve up.
2. Insert DE-GAS adjuster knob on thread of the valve.
3. Press the DE-GAS adjuster knob with light hand force until you can hear the nitrogen escaping. Press only briefly to avoid too much nitrogen being discharged.
4. After adjustment, remove the DE-GAS adjuster knob, mount the end fittings and test the gas spring in your application. If necessary repeat the procedure.

If you use 2 gas springs in parallel, both gas springs should have the same force to avoid bending forces or side load on the application. If necessary return to ACE to refill both gas springs to the same (average) force.

If too much nitrogen is discharged, the units can be returned to ACE for re-gassing.



DE-GAS

You can also visit our Youtube channel at www.youtube.com/user/acecontrolsglobal
Here, among other things you will find an ACETips-Video on the topic of DE-GAS!

Gas Spring Refilling Kit

Flexible and easy to use

The ACE gas spring refilling kit offers you the opportunity to fill gas springs on location or adapt them individually. The refilling kit is equipped with all the parts you need to fill gas springs. Very precise filling of the gas springs is possible using the digital manometer. The table for determining the filling pressure of the gas springs is included with the case. The only thing missing from the delivery is the nitrogen.



The refilling kit contains all filling bells and adjuster knobs for the current ACE gas spring range.

Gas springs filled with the refilling kit must be measured on a calibrated measurement system by ACE for repeat production.

The refilling kit suits 200 bar nitrogen bottles with a thread of W24,32x1/14" (German standard). Other connections are available upon request.

Part number: **GS-FK-C**

Hydraulic Dampers

Multi-talent in speed control

The hydraulic dampers are similar in appearance to the ACE industrial gas springs but are adjusted in the end position and work differently to the DVC family with individual speed adjusters for the push and pull direction. This provide users with the maximum flexibility.

Whether used as drive compensation or safety elements, the retraction and extension speed of these ACE solutions can always be precisely set. This means that the speed of movement can be controlled, synchronisation regulated in both directions and pivoting loads can be compensated. Depending on the model, the push and pull forces are between 30 N and 40,000 N. These maintenance-free, ready-to-install products are available in body diameters of 12 mm to 70 mm and in stroke lengths up to 800 mm.



Hydraulic Dampers



DVC-32

Page 178

Adjustable, Without Free Travel

Individual speed adjustment in both directions

Cylinder speed controls, Absorption control, Finishing and processing centres



HBD-50 to HBD-85

Page 180

Adjustable, Without Free Travel

Regulation at the highest level

Sports equipment, Rehabilitation technology, Conveyor technology



HBS-28 to HBS-70

Page 184

Adjustable, Without Free Travel

Direction change backlash free linear motion regulation

Oscillation insulation, Chairlift impact control, Fairground rides, Cylinder speed controls



HB-12 to HB-70

Page 188

Adjustable

Linear motion control

Conveyor systems, Transport systems, Furniture industry, Locking systems

Door Dampers



TD, TDE

Page 196

Adjustable

The safe way to close doors

Lift doors, Automatic doors, Doors

Constant speed rates

Sensitive adjustment

High quality and long lifetime

Easy to mount



DVC-32

Individual speed adjustment in both directions

Adjustable, Without Free Travel

Compression and extension force 42 N to 2,000 N

Stroke 50 mm to 150 mm

Can be regulated separately in any stroke position: The hydraulic dampers in the DVC-32 model are the first model to have the ability to have the in and out speeds adjusted independently from the outside and therefore more precisely. With their individual adjustment segments for the push and pull direction as well as the double-sided action, these are suitable as safety or control elements.

The great number of mounting accessories makes assembly of these hydraulic dampers by ACE easier and allows these maintenance-free, ready-to-install and self-contained systems universally applicable. Qualitatively high grade, and at the same time simple to use; one of their uses is to absorb swinging loads.

These machine elements are used, for one, in the automotive sector and industrial applications as well as in mechanical engineering and the electronics industry.

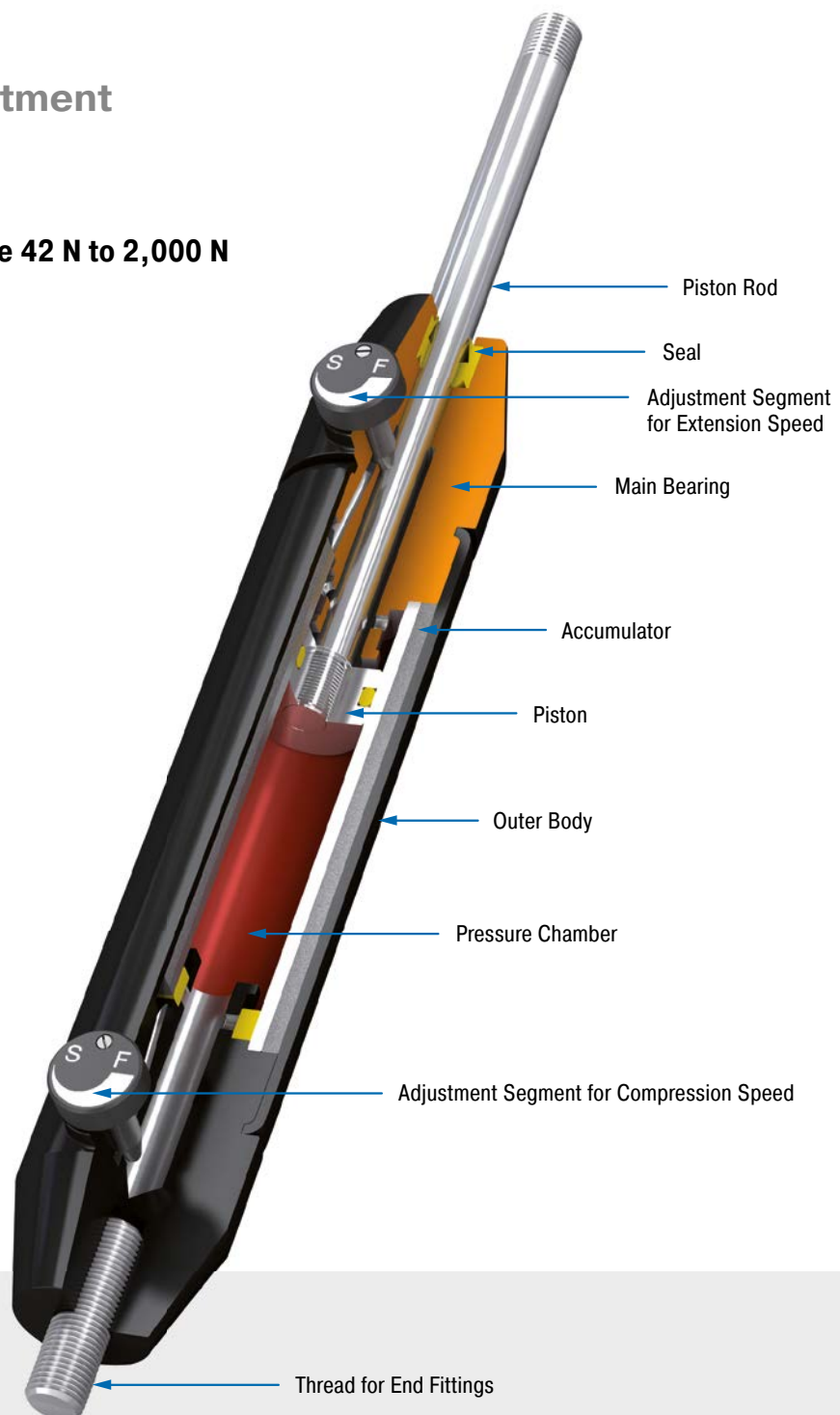

Technical Data

Compression and extension force: 42 N to 2,000 N

Outer body diameter: Ø 32 mm

Piston rod diameter: Ø 8 mm

Lifetime: Approx. 10,000 m

Operating temperature range: 0 °C to 65 °C

Adjustment: Steplessly adjustable

Positive stop: External positive stops 1 mm to 1.5 mm before the end of stroke provided by the customer.

Damping medium: Automatic Transmission Fluid (ATF)

Material: Outer body: Coated aluminium; Piston rod: Hard chrome plated steel; End fittings: Zinc plated steel

Mounting: In any position

Application field: Cylinder speed controls, Absorption control, Finishing and processing centres

Note: Increased break-away force if unit has not moved for some time. Damping force can be adjusted after installation.

End fittings: They are interchangeable and if necessary must be positively secured by the customer to prevent unscrewing.

On request: Special oils and other special options. Alternative accessories available on request.

Adjustable, Without Free Travel, Compression and extension force 42 N to 2,000 N

End Fitting

Standard Dimensions

End Fitting

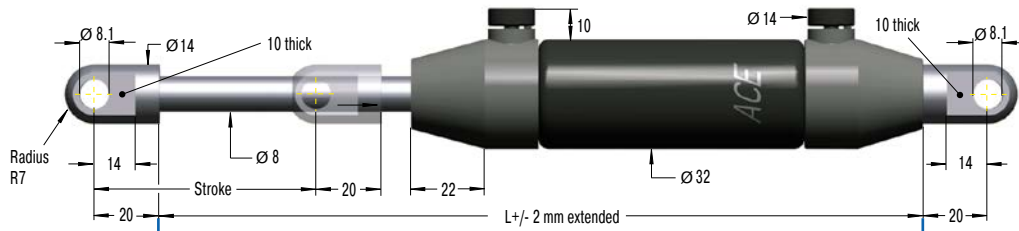
A8

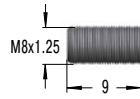
Eye A8
max. force 3,000 N

B8

Performance and Dimensions

TYPES	Stroke mm	L extended mm	¹ Compression force max. N
DVC-32-50EU	50	240	2,000
DVC-32-100EU	100	340	1,670
DVC-32-150EU	150	440	1,335

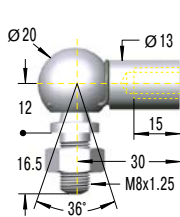
¹ Max. extension force for all stroke lengths 2,000 N.

Stud Thread B8
C8

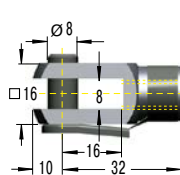
Angle Ball Joint C8
max. force 1,200 N

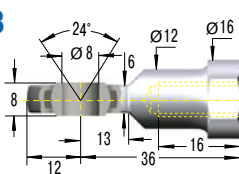
D8

Clevis Fork D8
max. force 3,000 N

E8

Swivel Eye E8
max. force 3,000 N

Ordering Example

DVC-32-50EU-DD-P

Type (Hydraulic Damper) _____
 Body Ø (32 mm) _____
 Stroke (50 mm) _____
 EU Compliant _____
 Piston Rod End Fitting D8 _____
 Body End Fitting D8 _____
 Damping Direction (P = both directions) _____

Model Type Prefix

P: Damping in both directions (standard model)
 M: Damping on out stroke only (adjustment knob at "rear end" free flow)
 N: Damping on in stroke only (adjustment knob at "piston rod end" free flow)

End fittings: They are interchangeable and if necessary must be positively secured by the customer to prevent unscrewing.

Mounting accessories see from page 200.

DVC-32EU-xx

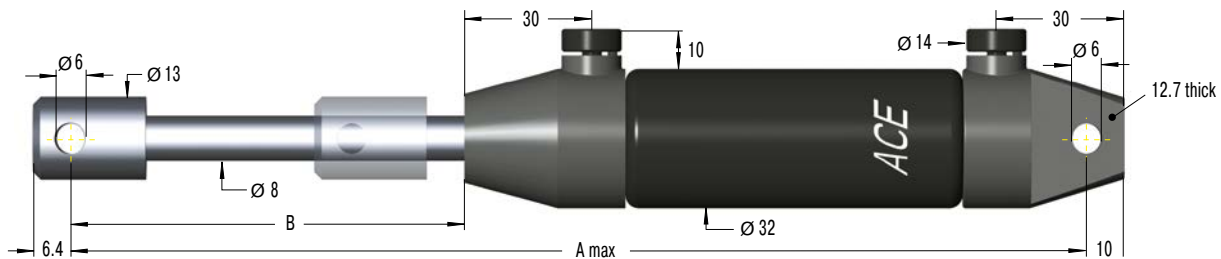

Performance and Dimensions

TYPES	Stroke mm	A max. mm	B mm	Compression force max. N	Traction Force Range max. N
DVC-32-50EU-XX	50	250	75.2	2,000	2,000
DVC-32-100EU-XX	100	350	124.4	1,670	2,000
DVC-32-150EU-XX	150	450	173.6	1,335	2,000

HBD-50 to HBD-85

Regulation at the highest level

Adjustable, Without Free Travel

Compression and extension force 100 N to 50,000 N

Stroke 50 mm to 700 mm

Motion control in both directions: The HBD model of hydraulic dampers can be adjusted independently in both the push and pull direction. These maintenance-free, ready-to-install and closed systems leave no prayers unanswered as far as the setting of retraction and extension speeds are concerned. In addition each damper works without any free travel therefore the flow of oil can be regulated exactly via the two precision metering orifices.

Adjustment can be made once installed and even when moving through stroke. The coated body and hard-chromed piston rods stand for quality and long service life. The variety of mounting accessories makes assembly easy and the high-end hydraulic dampers universally usable.

HBD hydraulic dampers are used in the automotive, in industry, mechanical engineering and medical technology.

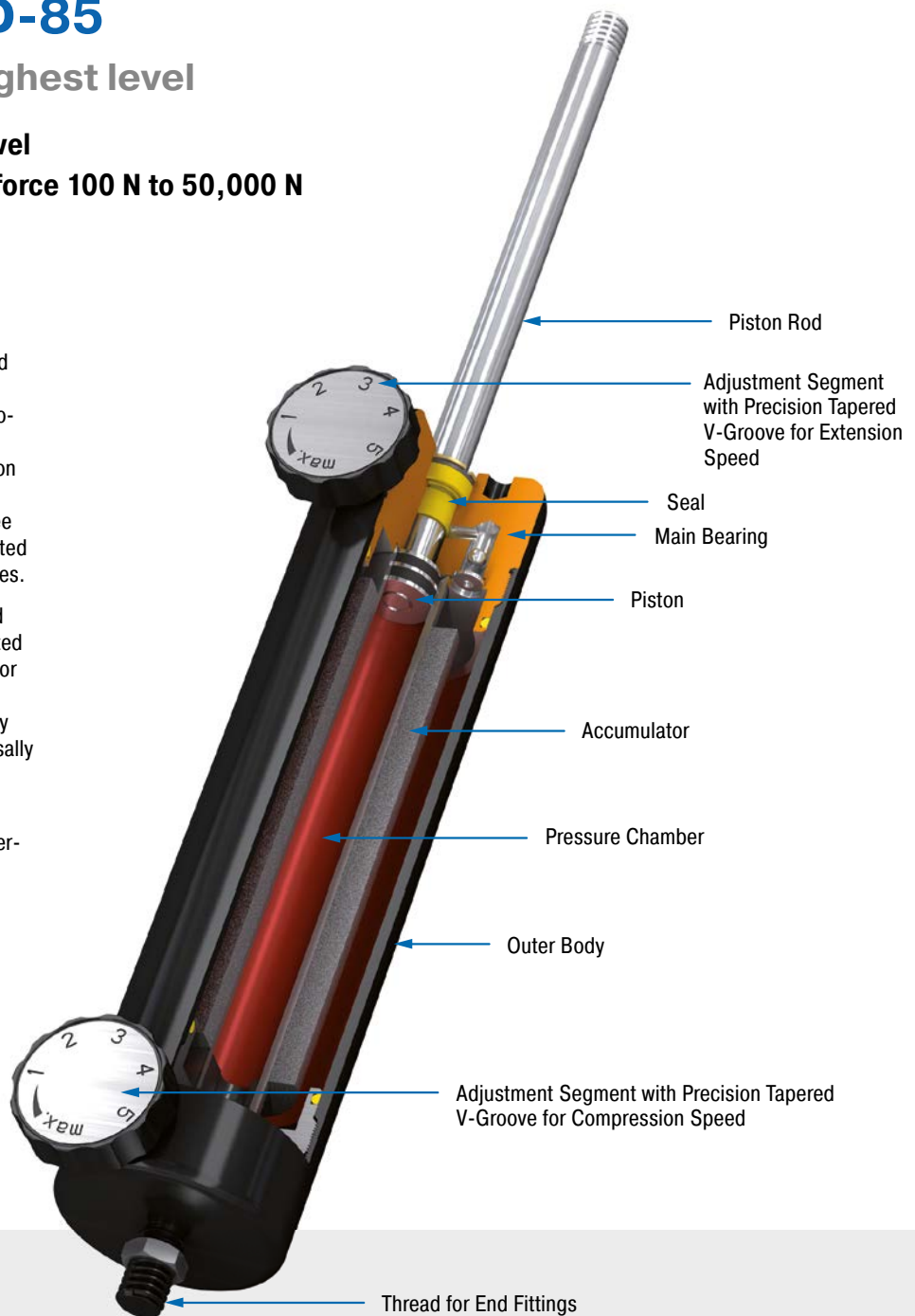

Technical Data

Compression and extension force: 100 N to 50,000 N

Outer body diameter: Ø 50 mm to Ø 85 mm

Piston rod diameter: Ø 10 mm to Ø 20 mm

Lifetime: Approx. 10,000 m

Operating temperature range: 0 °C to 65 °C

Adjustment: Steplessly adjustable

Positive stop: External positive stops 1 mm to 3 mm before the end of stroke provided by the customer.

Damping medium: hydraulic oil

Material: Outer body: coated steel; Piston rod: hard chrome plated steel; End fittings: zinc plated steel

Mounting: in any position

Application field: sports equipment, rehabilitation technology, conveyor technology

Note: Increased break-away force if unit has not moved for some time. One locknut included.

End fittings: They are interchangeable and if necessary must be positively secured by the customer to prevent unscrewing.

On request: Special oils and other special options. Alternative accessories available on request.

Adjustable, Without Free Travel, Compression and extension force 100 N to 6,000 N

End Fitting

Standard Dimensions

End Fitting

B10

Stud Thread **B10**

Performance and Dimensions

TYPES	Stroke mm	L extended mm	¹ Compression force max. N
HBD-50-50	50	192	6.000
HBD-50-100	100	292	6.000
HBD-50-150	150	392	4.400
HBD-50-200	200	492	2.800
HBD-50-250	250	592	2.000
HBD-50-300	300	692	1.400

¹ Max. extension force for all stroke lengths 6,000 N.

A10

Eye **A10**
max. force 10,000 N

C10

Angle Ball Joint **C10**
max. force 1,800 N

Ordering Example

HBD-50-150-EE

Type (Hydraulic Damper) _____

Body Ø (50 mm) _____

Stroke (150 mm) _____

Piston Rod End Fitting E10 _____

Body End Fitting E10 _____

D10

Clevis Fork **D10**
max. force 10,000 N

E10

Swivel Eye **E10**
max. force 10,000 N

Model Type Prefix

P: Damping in both directions (standard model)
 M: Damping on out stroke only (adjustment knob at "rear end" free flow)
 N: Damping on in stroke only (adjustment knob at "piston rod end" free flow)

Mounting accessories see from
page 200.

Issue 07.2017 – Specifications subject to change

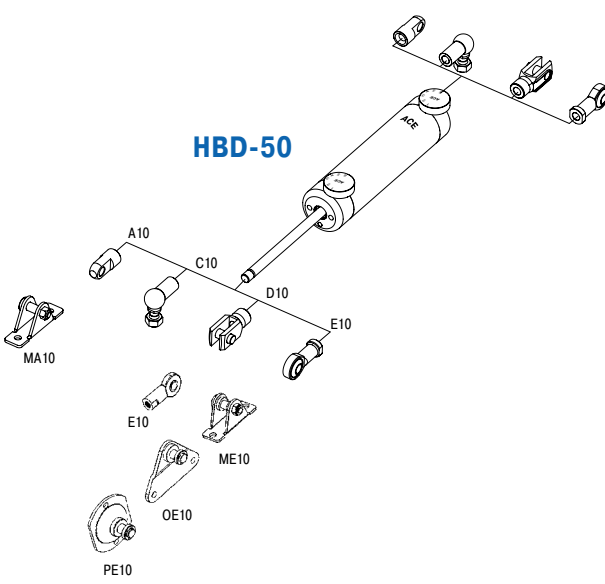

Technical Data

- Compression and extension force:** 100 N to 6,000 N
- Operating temperature range:** 0 °C to 65 °C
- Adjustment:** Steplessly adjustable
- Positive stop:** External positive stops 1 mm to 1.5 mm before the end of stroke provided by the customer.
- Material:** Outer body: Coated steel; Piston rod: Hard chrome plated steel; End fittings: Zinc plated steel
- Mounting:** In any position
- Note:** Increased break-away force if unit has not moved for some time. One locknut included.
- End fittings:** They are interchangeable and if necessary must be positively secured by the customer to prevent unscrewing.

Adjustable, Without Free Travel, Compression and extension force 150 N to 10,000 N

End Fitting

Standard Dimensions

End Fitting

B14 Stud Thread **B14**

A14 Eye **A14**
max. force 10,000 N

C14 Angle Ball Joint **C14**
max. force 3,200 N

D14 Clevis Fork **D14**
max. force 10,000 N

E14 Swivel Eye **E14**
max. force 10,000 N

Performance and Dimensions

TYPES	Stroke mm	L extended mm	¹ Compression force max. N
HBD-70-100	100	306	10,000
HBD-70-150	150	406	10,000
HBD-70-200	200	506	10,000
HBD-70-300	300	706	10,000
HBD-70-400	400	906	8,000
HBD-70-500	500	1,106	6,000

¹ Max. extension force for all stroke lengths 10,000 N.

Ordering Example

HBD-70-300-EE

Type (Hydraulic Damper) _____
 Body Ø (70 mm) _____
 Stroke (300 mm) _____
 Piston Rod End Fitting E14 _____
 Body End Fitting E14 _____

Model Type Prefix

P: Damping in both directions (standard model)
 M: Damping on out stroke only (adjustment knob at "rear end" free flow)
 N: Damping on in stroke only (adjustment knob at "piston rod end" free flow)

Mounting accessories see from page 200.

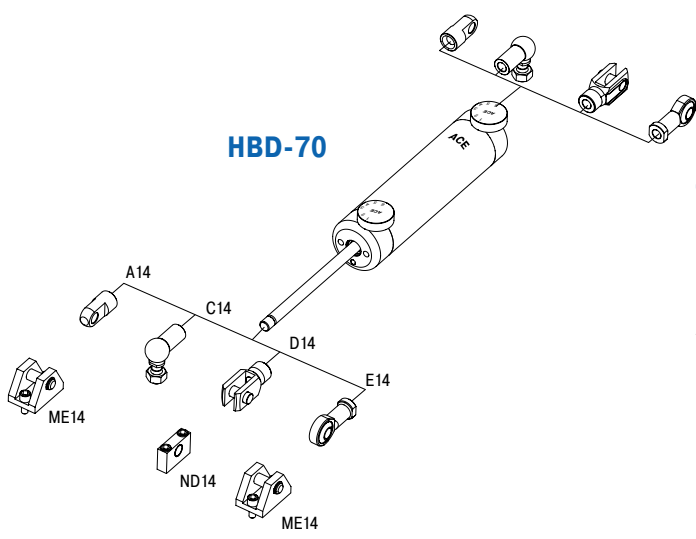

Technical Data

- Compression and extension force:** 150 N to 10,000 N
- Operating temperature range:** 0 °C to 65 °C
- Adjustment:** Steplessly adjustable
- Positive stop:** External positive stops 1 mm to 1.5 mm before the end of stroke provided by the customer.
- Material:** Outer body: Coated steel; Piston rod: Hard chrome plated steel; End fittings: Zinc plated steel
- Mounting:** In any position
- Note:** Increased break-away force if unit has not moved for some time. One locknut included.
- End fittings:** They are interchangeable and if necessary must be positively secured by the customer to prevent unscrewing.

Adjustable, Without Free Travel, Compression and extension force 150 N to 50,000 N

End Fitting

Standard Dimensions

End Fitting

B24 M24x2 Thread Adaptor

D24 Clevis Fork **D24** max. force 50,000 N

E24 Swivel Eye **E24** max. force 50,000 N

Stroke: $\varnothing 20$

Body $\varnothing 85$

L +/- 2 mm extended

Dimensions: 28, 14, 17, 35, 35, 100, 94, 30, 30, 94, 40, 31, 30, 22, 25, 34, 42, 50, 25, 32, 100

Performance and Dimensions			
TYPES	Stroke mm	L extended mm	¹ Compression force max. N
HBD-85-100	100	313	50,000
HBD-85-150	150	413	30,000
HBD-85-200	200	513	20,000
HBD-85-300	300	713	10,000
HBD-85-400	400	913	6,500
HBD-85-500	500	1,113	4,000
HBD-85-600	600	1,313	3,000
HBD-85-700	700	1,513	2,000

¹ Max. extension force for all stroke lengths 50,000 N.

Ordering Example

HBD-85-300-EE

Type (Hydraulic Damper) _____

Body \varnothing (85 mm) _____

Stroke (300 mm) _____

Piston Rod End Fitting E24 _____

Body End Fitting E24 _____

Model Type Prefix

P: Damping in both directions (standard model)
 M: Damping on out stroke only (adjustment knob at "rear end" free flow)
 N: Damping on in stroke only (adjustment knob at "piston rod end" free flow)

Mounting accessories see from page 200.

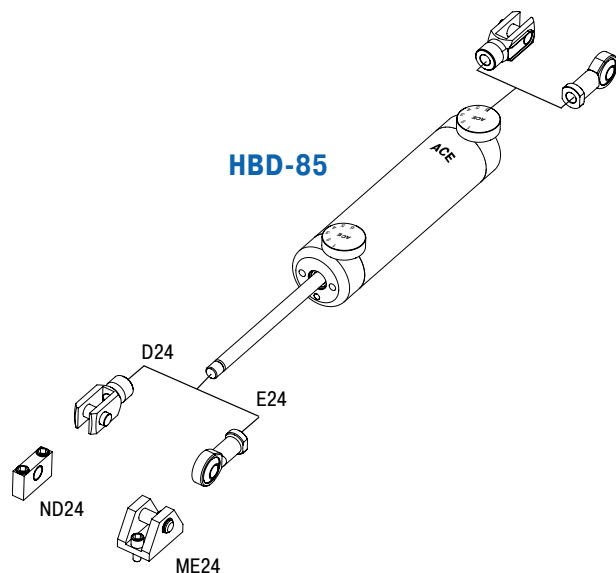

Technical Data

Compression and extension force: 150 N to 50,000 N

Operating temperature range: 0 °C to 65 °C

Adjustment: Steplessly adjustable

Positive stop: External positive stops 2 mm to 3 mm before the end of stroke provided by the customer.

Material: Outer body: Coated steel; Piston rod: Hard chrome plated steel; End fittings: Zinc plated steel

Mounting: In any position

Note: Increased break-away force if unit has not moved for some time. Thread adaptor for piston rod from M16 to M24 included.

End fittings: They are interchangeable and if necessary must be positively secured by the customer to prevent unscrewing.

HBS-28 to HBS-70

Direction change backlash free linear motion regulation

Adjustable, Without Free Travel

Compression and extension force 30 N to 40,000 N

Stroke 50 mm to 800 mm

Damping either in one or both directions: The HBS models of hydraulic dampers are made in a slim gas spring design and are compact and high in performance. Maintenance-free and ready-to-install they allow precise setting of retraction and extension speeds without any free travel when changing direction.

These hydraulic dampers offer constant feeding rates and can be finely tuned via the screw adjustment. A control segment on the piston makes the adjustment at the end position child's play. Thanks to many add-on components the assembly is easy to mount, so that the damper can be universally deployed for damping back and forth swinging masses, such as in power or free conveyors.

In addition to the automotive sector, the application areas are industrial applications, classic mechanical engineering, the electronics and furniture industry and medical technology.

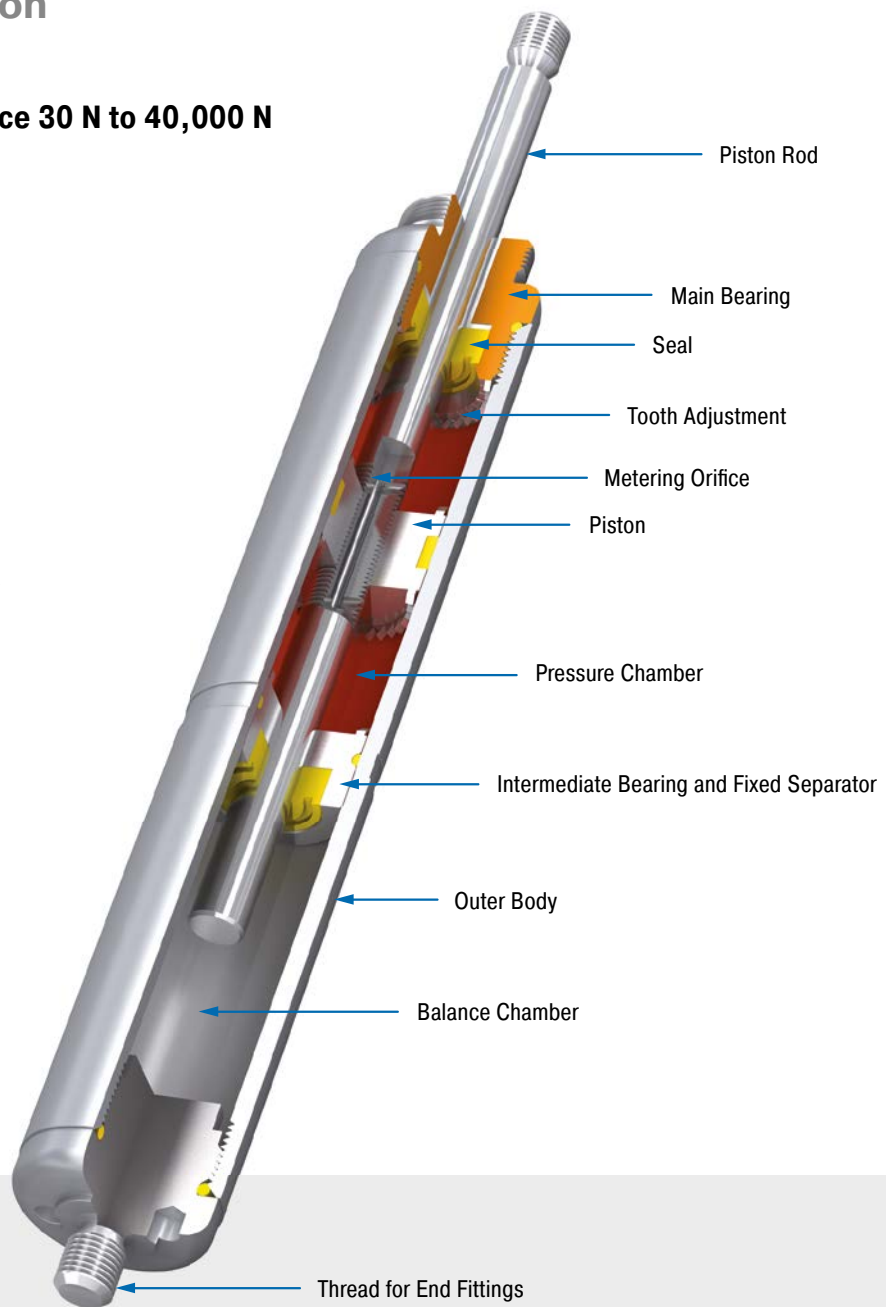

Technical Data

Compression and extension force: 30 N to 40,000 N

Outer body diameter: Ø 28 mm to Ø 70 mm

Piston rod diameter: Ø 8 mm to Ø 30 mm

Lifetime: Approx. 10,000 m

Operating temperature range: -20 °C to +80 °C

Adjustment: Achieved by turning the piston rod in its fully extended or compressed position.

Positive stop: External positive stops 1 mm to 6 mm before the end of stroke provided by the customer.

Damping medium: Hydraulic oil

Material: Outer body: Zinc plated or coated steel; Piston rod: Hard chrome plated steel; End fittings: Zinc plated steel

Mounting: In any position

Application field: Oscillation insulation, Chairlift impact control, Fairground rides, Cylinder speed controls, Absorption control

Note: Increased break-away force if unit has not moved for some time.

End fittings: They are interchangeable and if necessary must be positively secured by the customer to prevent unscrewing.

Safety instructions: For long strokes with high forces use swivel mounting block MBS.

On request: Special oils and other special options. Alternative accessories available on request.

Adjustable, Without Free Travel, Compression and extension force 30 N to 3,000 N

End Fitting

Standard Dimensions

End Fitting

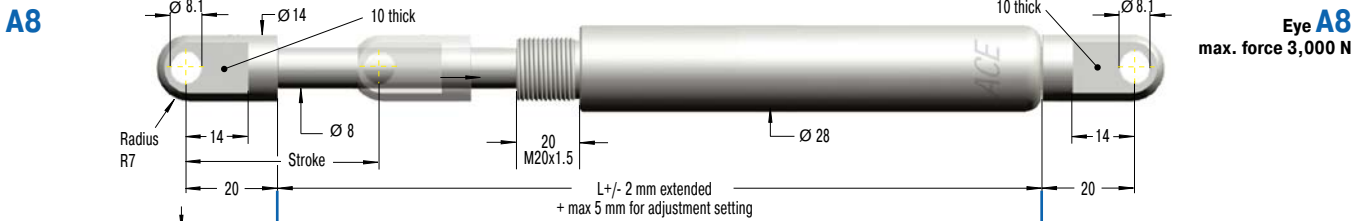

B8

C8

D8

E8

G8

Performance and Dimensions

TYPES	Stroke mm	L extended mm	¹ Compression force max. N	¹ Compression force with MBS max. N
HBS-28-50	62	297	3,000	3,000
HBS-28-100	112	447	1,550	3,000
HBS-28-150	162	597	900	3,000
HBS-28-200	212	747	600	3,000
HBS-28-250	262	897	440	3,000
HBS-28-300	312	1,047	330	3,000
HBS-28-350	362	1,197	260	2,500
HBS-28-400	412	1,347	200	2,000

¹ Max. extension force for all stroke lengths 3,000 N.

Ordering Example

Type (Hydraulic Damper) **HBS-28-150-DD-M**
 Body Ø (28 mm)
 Stroke (150 mm)
 Piston Rod End Fitting D8
 Body End Fitting D8
 Damping Direction (M = out stroke only)

Model Type Prefix

P: Damping in both directions
 N: Damping on in stroke only
 M: Damping on out stroke only
 X: Special model suffix

Mounting accessories see from page 200.

Stud Thread B8

Angle Ball Joint C8 max. force 1,200 N

Clevis Fork D8 max. force 3,000 N

Swivel Eye E8 max. force 3,000 N

Ball Socket G8 max. force 1,200 N

Rod Shroud
 no retrofit
 Ø 32, L = Stroke + 80

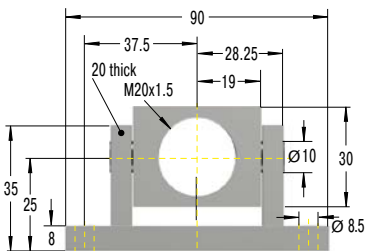

Swivel Mounting Block MBS-28

HBS-28

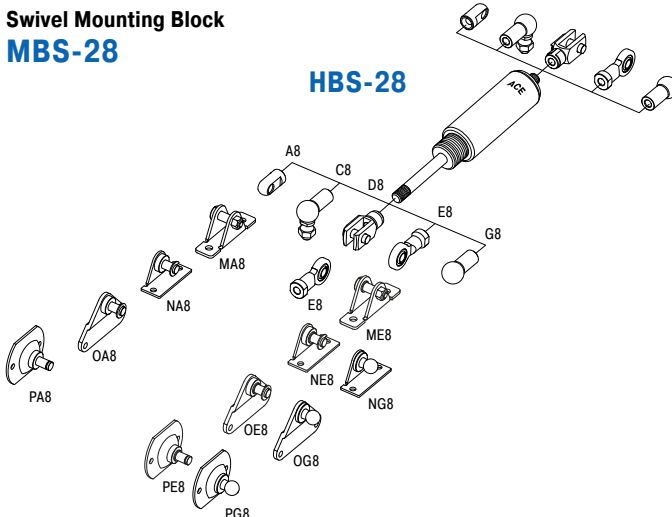

Technical Data

Compression and extension force: 30 N to 3,000 N

Operating temperature range: -20 °C to +80 °C

Adjustment: Achieved by turning the piston rod in its fully extended or fully compressed position.

Clockwise rotation = increase of the damping

Anti-clockwise rotation = decrease of the damping

Damping force adjustable before installation. The adjustment can add a max. of 5 mm to the L dimension.

Positive stop: External positive stops 1 mm to 1.5 mm before the end of stroke provided by the customer.

Material: Outer body: Zinc plated or coated steel; Piston rod: Hard chrome plated steel; End fittings: Zinc plated steel

Mounting: In any position

Note: Increased break-away force if unit has not moved for some time.

End fittings: They are interchangeable and if necessary must be positively secured by the customer to prevent unscrewing.

Safety instructions: For long strokes with high forces use swivel mounting block MBS.

Adjustable, Without Free Travel, Compression and extension force 30 N to 10,000 N

End Fitting

Standard Dimensions

End Fitting

A10

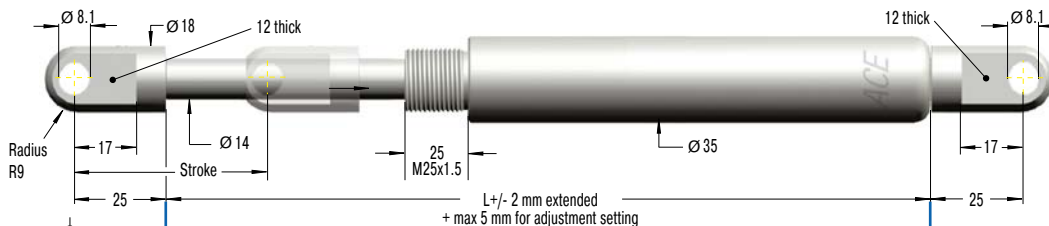

Eye A10
max. force 10,000 N

B10

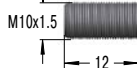

Stud Thread B10

C10

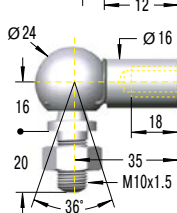

Angle Ball Joint C10
max. force 1,800 N

D10

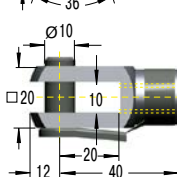

Clevis Fork D10
max. force 10,000 N

E10

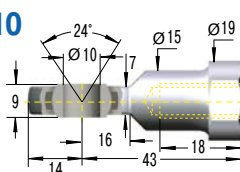

Swivel Eye E10
max. force 10,000 N

Performance and Dimensions

TYPES	Stroke mm	L extended mm	¹ Compression force max. N	¹ Compression force with MBS max. N
HBS-35-100	117	487	10,000	10,000
HBS-35-150	167	637	7,500	10,000
HBS-35-200	217	787	5,150	10,000
HBS-35-300	317	1,087	2,850	10,000
HBS-35-400	417	1,387	1,800	10,000
HBS-35-500	517	1,687	1,240	10,000
HBS-35-600	617	1,987	910	8,600
HBS-35-700	717	2,287	690	6,500
HBS-35-800	817	2,587	540	5,100

¹ Max. extension force for all stroke lengths 10,000 N.

Ordering Example

HBS-35-300-EE-N

- Type (Hydraulic Damper) _____
- Body Ø (35 mm) _____
- Stroke (300 mm) _____
- Piston Rod End Fitting E10 _____
- Body End Fitting E10 _____
- Damping Direction (N = in stroke only) _____

Model Type Prefix

- P: Damping in both directions
- N: Damping on in stroke only
- M: Damping on out stroke only
- X: Special model suffix

Mounting accessories see from page 200.

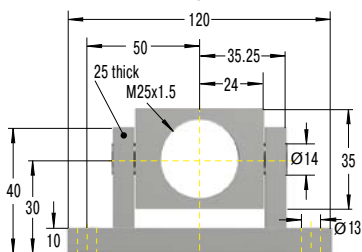

Swivel Mounting Block MBS-35

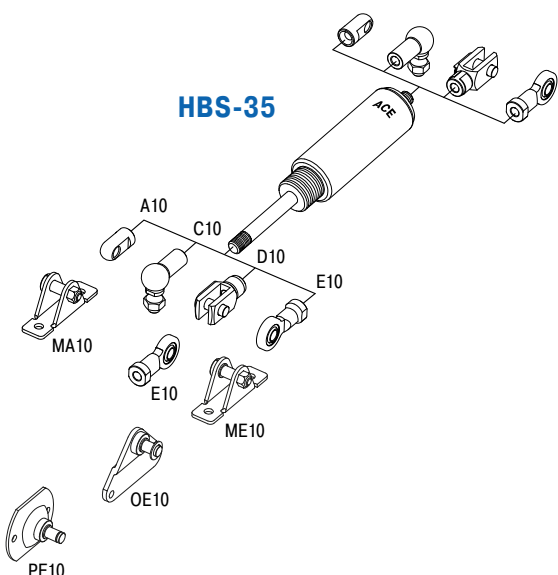

Technical Data

- Compression and extension force:** 30 N to 10,000 N
- Operating temperature range:** -20 °C to +80 °C
- Adjustment:** Achieved by turning the piston rod in its fully extended or fully compressed position.
Clockwise rotation = increase of the damping
Anti-clockwise rotation = decrease of the damping
Damping force adjustable before installation. The adjustment can add a max. of 5 mm to the L dimension.
- Positive stop:** External positive stops 1 mm to 1.5 mm before the end of stroke provided by the customer.
- Material:** Outer body: Zinc plated or coated steel; Piston rod: Hard chrome plated steel; End fittings: Zinc plated steel
- Mounting:** In any position
- Note:** Increased break-away force if unit has not moved for some time.
- End fittings:** They are interchangeable and if necessary must be positively secured by the customer to prevent unscrewing.
- Safety instructions:** For long strokes with high forces use swivel mounting block MBS.

Adjustable, Without Free Travel, Compression and extension force 2,000 N to 40,000 N

End Fitting

Standard Dimensions

End Fitting

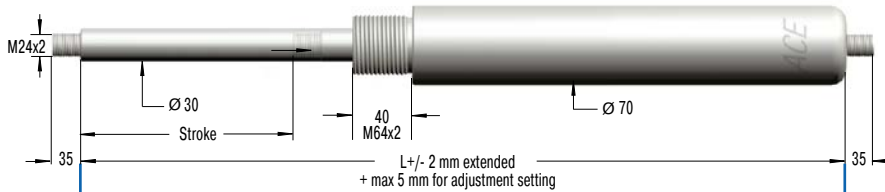
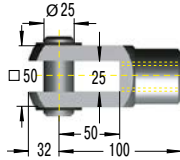
B24

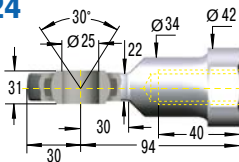
Stud Thread B24
D24

Clevis Fork D24
max. force 50,000 N

E24

Swivel Eye E24
max. force 50,000 N

Performance and Dimensions

TYPES	Stroke mm	L extended mm	¹ Compression force max. N	¹ Compression force with MBS max. N
HBS-70-100	111	561	40,000	40,000
HBS-70-200	211	861	40,000	40,000
HBS-70-300	311	1,161	40,000	40,000
HBS-70-400	411	1,461	30,300	40,000
HBS-70-500	511	1,761	21,600	40,000
HBS-70-600	611	2,061	16,200	40,000
HBS-70-700	711	2,361	12,600	40,000
HBS-70-800	811	2,661	10,100	40,000

¹ Max. extension force for all stroke lengths 40,000 N.

Ordering Example

HBS-70-300-EE-N

Type (Hydraulic Damper) _____

Body Ø (70 mm) _____

Stroke (300 mm) _____

Piston Rod End Fitting E24 _____

Body End Fitting E24 _____

Damping Direction (N = in stroke only) _____

Model Type Prefix

P: Damping in both directions
 N: Damping on in stroke only
 M: Damping on out stroke only
 X: Special model suffix

Mounting accessories see from page 200.

Rod Shroud W24-70
Ø 80, L = Stroke + 180

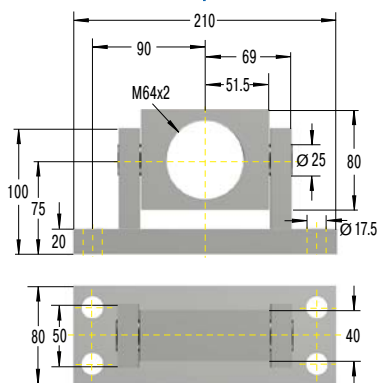

Swivel Mounting Block MBS-70

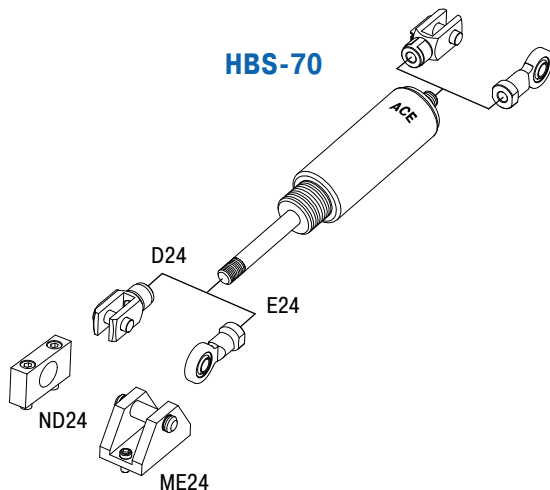

Technical Data

Compression and extension force: 2,000 N to 40,000 N

Operating temperature range: -20 °C to +80 °C

Adjustment: Achieved by turning the piston rod in its fully extended or fully compressed position.

Clockwise rotation = increase of the damping

Anti-clockwise rotation = decrease of the damping

Damping force adjustable before installation. The adjustment can add a max. of 5 mm to the L dimension.

Positive stop: External positive stops 5 mm to 6 mm before the end of stroke provided by the customer.

Material: Outer body: Zinc plated or coated steel; Piston rod: Hard chrome plated steel; End fittings: Zinc plated steel

Mounting: In any position

Note: Increased break-away force if unit has not moved for some time.

End fittings: They are interchangeable and if necessary must be positively secured by the customer to prevent unscrewing.

Safety instructions: For long strokes with high forces use swivel mounting block MBS.

HB-12 to HB-70

Linear motion control

Adjustable

Compression and extension force 20 N to 50,000 N

Stroke 10 mm to 800 mm

High quality and long service life: The HB model of hydraulic damper can also be used as single or double acting brake. Its coated body in a slim gas spring design and the piston rods with wear-resistant surface coating are features of high quality and long service life.

The maintenance free, ready-to-install and closed systems provide a constant feed rate and are adjustable, and the control segment on the piston makes adjustment at the end position child's play. Thanks to many add-on components the assembly is easy to mount, so that the damper can be universally deployed for damping back and forth swinging masses, such as in power or free conveyors.

On automotive or industrial applications, mechanical engineering, medical technology or the electronics and furniture industry, these machine elements are found in a number of different areas.

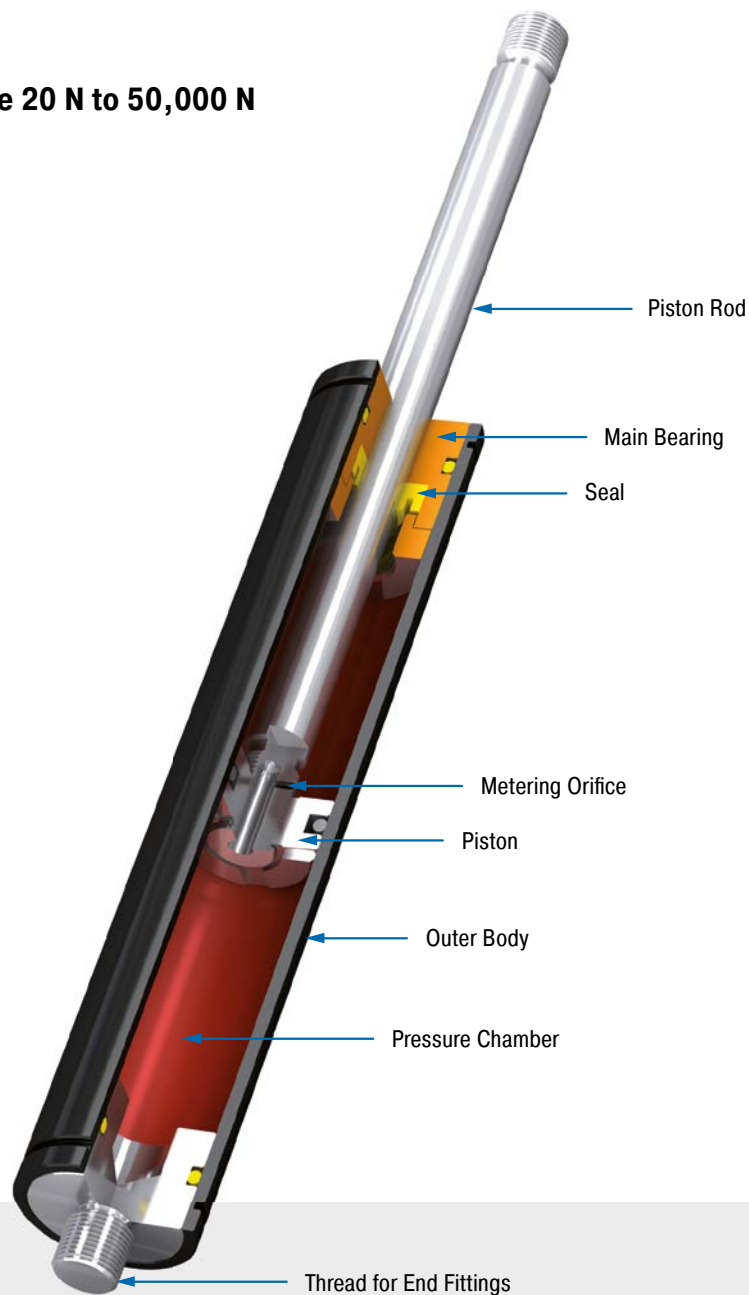

Technical Data

Compression and extension force: 20 N to 50,000 N

Outer body diameter: Ø 12 mm to Ø 70 mm

Piston rod diameter: Ø 4 mm to Ø 30 mm

Lifetime: Approx. 10,000 m

Free travel: Construction of the damper results in a free travel of approx. 20 % of stroke.

Separator piston: Available as a special option without free travel achieved by separator piston and nitrogen accumulator.

Operating temperature range: -20 °C to +80 °C

Adjustment: Achieved by turning the piston rod in its fully extended or fully compressed position.

Positive stop: External positive stops 1 mm to 6 mm before the end of stroke provided by the customer.

Damping medium: Hydraulic oil

Material: Outer body: Coated steel; Piston rod: Steel or stainless steel with wear-resistant coating; End fittings: Zinc plated steel

Mounting: In any position

Application field: Conveyor systems, Transport systems, Furniture industry, Locking systems, Sports equipment

Note: Increased break-away force if unit has not moved for some time.

End fittings: They are interchangeable and if necessary must be positively secured by the customer to prevent unscrewing.

On request: Special oils and other special options. Alternative accessories available on request.

Adjustable, Compression and extension force 20 N to 180 N

End Fitting

Standard Dimensions

End Fitting

A3,5

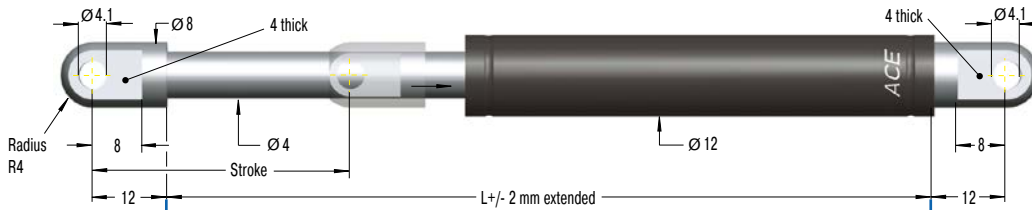

Eye A3,5
max. force 370 N

B3,5



Stud Thread B3,5

C3,5

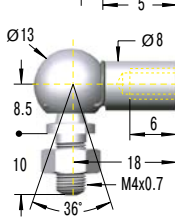

Angle Ball Joint C3,5
max. force 370 N

D3,5

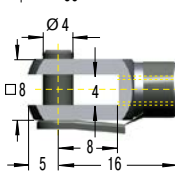

Clevis Fork D3,5
max. force 370 N

E3,5

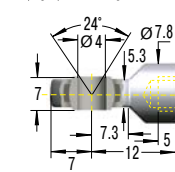

Swivel Eye E3,5
max. force 370 N

G3,5

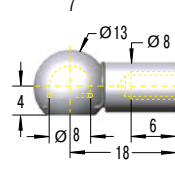

Ball Socket G3,5
max. force 370 N

Rod Shroud W3,5-12

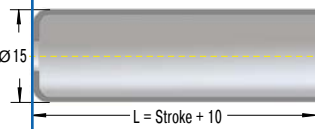

Performance and Dimensions

TYPES	Stroke mm	L extended mm	¹ Compression force max. N
HB-12-10	10	55	180
HB-12-20	20	75	180
HB-12-30	30	95	180
HB-12-40	40	115	180
HB-12-50	50	135	180
HB-12-60	60	155	180
HB-12-70	70	175	180
HB-12-80	80	195	150

¹ Max. extension force for all stroke lengths 180 N.

Ordering Example

Type (Hydraulic Damper) _____ **HB-12-30-AC-M**
 Body Ø (12 mm) _____
 Stroke (30 mm) _____
 Piston Rod End Fitting A3,5 _____
 Body End Fitting C3,5 _____
 Damping Direction (M = out stroke only) _____

Model Type Prefix

P: Damping in both directions
 N: Damping on in stroke only
 M: Damping on out stroke only
 X: Special model suffix

Mounting accessories see from page 200.

Technical Data

Compression and extension force: 20 N to 180 N

Free travel: Construction of the damper results in a free travel of approx. 21 % of stroke.

Separator piston: -

Operating temperature range: -20 °C to +80 °C

Adjustment: Achieved by turning the piston rod in its fully extended or fully compressed position.

Clockwise rotation = increase of the damping

Anti-clockwise rotation = decrease of the damping

Damping force adjustable before installation. Adjustment can add a max. of 6 mm to the L dimension.

Positive stop: External positive stops 1 mm to 1.5 mm before the end of stroke provided by the customer.

Material: Outer body: coated steel; Piston rod: stainless steel (1.4301/1.4305, AISI 304/303); End fittings: zinc plated steel

Mounting: in any position

Note: Increased break-away force if unit has not moved for some time.

End fittings: They are interchangeable and if necessary must be positively secured by the customer to prevent unscrewing.

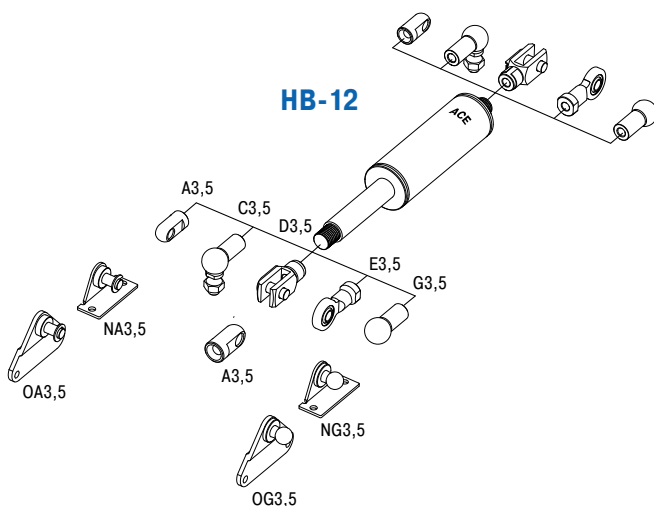

Adjustable, Compression and extension force 20 N to 800 N

End Fitting

Standard Dimensions

End Fitting

A5



Eye A5
max. force 800 N

B5



Stud Thread B5

C5

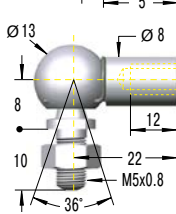

Angle Ball Joint C5
max. force 500 N

D5

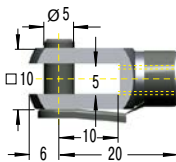

Clevis Fork D5
max. force 800 N

E5

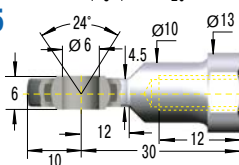

Swivel Eye E5
max. force 800 N

G5

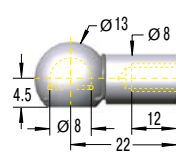

Ball Socket G5
max. force 500 N

Rod Shroud W5-15

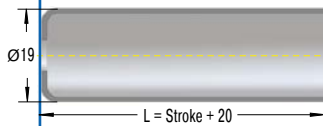

Performance and Dimensions

TYPES	Stroke mm	L extended mm	¹ Compression force max. N
HB-15-25	25	93	800
HB-15-50	50	143	800
HB-15-75	75	193	800
HB-15-100	100	243	350
HB-15-150	150	343	300

¹ Max. extension force for all stroke lengths 800 N.

Ordering Example

HB-15-150-CC-M

Type (Hydraulic Damper) _____
 Body Ø (15.6 mm) _____
 Stroke (150 mm) _____
 Piston Rod End Fitting C5 _____
 Body End Fitting C5 _____
 Damping Direction (M = out stroke only) _____

Model Type Prefix

P: Damping in both directions
 N: Damping on in stroke only
 M: Damping on out stroke only
 X: Special model suffix

Mounting accessories see from page 200.

Technical Data

Compression and extension force: 20 N to 800 N

Free travel: Construction of the damper results in a free travel of approx. 20 % of stroke.

Separator piston: Extension force 40 N; dimension L = 2.45 x stroke + 49 mm. Part number: add suffix -T.

Operating temperature range: -20 °C to +80 °C

Adjustment: Achieved by turning the piston rod in its fully extended or fully compressed position.

Clockwise rotation = increase of the damping

Anti-clockwise rotation = decrease of the damping

Damping force adjustable before installation. Adjustment can add a max. of 6 mm to the L dimension.

Positive stop: External positive stops 1 mm to 1.5 mm before the end of stroke provided by the customer.

Material: Outer body: coated steel; Piston rod: steel with wear-resistant coating; End fittings: zinc plated steel

Mounting: in any position

Note: Increased break-away force if unit has not moved for some time.

End fittings: They are interchangeable and if necessary must be positively secured by the customer to prevent unscrewing.

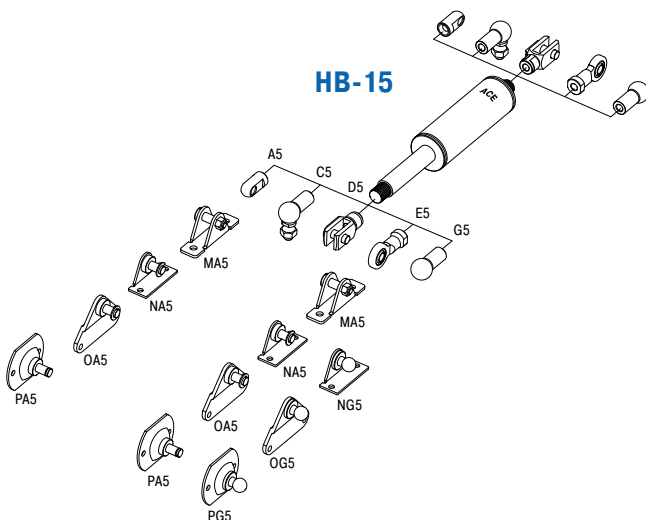

Adjustable, Compression and extension force 30 N to 1,800 N

End Fitting

Standard Dimensions

End Fitting

Performance and Dimensions

TYPES	Stroke mm	L extended mm	¹ Compression force max. N
HB-22-50	50	150	1,800
HB-22-100	100	250	1,800
HB-22-150	150	350	1,800
HB-22-200	200	450	1,000
HB-22-250	250	550	1,000

¹ Max. extension force for all stroke lengths 1,800 N.

Ordering Example **HB-22-150-DD-M**

Type (Hydraulic Damper) _____
 Body Ø (23 mm) _____
 Stroke (150 mm) _____
 Piston Rod End Fitting D8 _____
 Body End Fitting D8 _____
 Damping Direction (M = out stroke only) _____

Model Type Prefix
 P: Damping in both directions
 N: Damping on in stroke only
 M: Damping on out stroke only
 X: Special model suffix

Mounting accessories see from page 200.

End Fitting Options:
 Eye A8 max. force 3,000 N
 Stud Thread B8
 Angle Ball Joint C8 max. force 1,200 N
 Clevis Fork D8 max. force 3,000 N
 Swivel Eye E8 max. force 3,000 N
 Ball Socket G8 max. force 1,200 N

Rod Shroud W8-22
 Ø 28
 L = Stroke + 30

Technical Data

Compression and extension force: 30 N to 1,800 N

Free travel: Construction of the damper results in a free travel of approx. 20 % of stroke.

Separator piston: Extension force 50 N; dimension L = 2.38 x stroke + 55 mm. Part number: add suffix -T.

Operating temperature range: -20 °C to +80 °C

Adjustment: Achieved by turning the piston rod in its fully extended or fully compressed position.

Clockwise rotation = increase of the damping

Anti-clockwise rotation = decrease of the damping

Damping force adjustable before installation. Adjustment can add a max. of 6 mm to the L dimension.

Positive stop: External positive stops 1 mm to 1.5 mm before the end of stroke provided by the customer.

Material: Outer body: coated steel; Piston rod: steel with wear-resistant coating; End fittings: zinc plated steel

Mounting: in any position

Note: Increased break-away force if unit has not moved for some time.

End fittings: They are interchangeable and if necessary must be positively secured by the customer to prevent unscrewing.

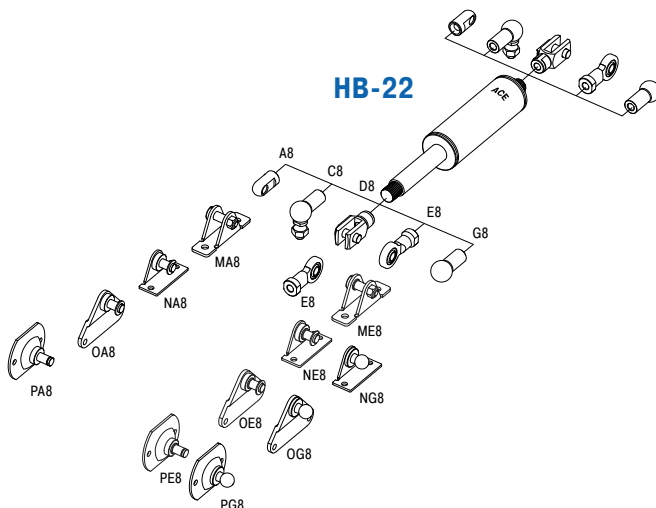

Adjustable, Compression and extension force 30 N to 3,000 N

End Fitting

Standard Dimensions

End Fitting

Performance and Dimensions

TYPES	Stroke mm	L extended mm	¹ Compression force max. N
HB-28-100	100	260	3,000
HB-28-150	150	360	3,000
HB-28-200	200	460	3,000
HB-28-250	250	560	3,000
HB-28-300	300	660	2,500
HB-28-350	350	760	2,000
HB-28-400	400	860	1,500
HB-28-500	500	1,060	1,000

¹ Max. extension force for all stroke lengths 3,000 N.

Ordering Example

HB-28-150-DD-M

Type (Hydraulic Damper) _____
 Body Ø (28 mm) _____
 Stroke (150 mm) _____
 Piston Rod End Fitting D8 _____
 Body End Fitting D8 _____
 Damping Direction (M = out stroke only) _____

Model Type Prefix

P: Damping in both directions
 N: Damping on in stroke only
 M: Damping on out stroke only
 X: Special model suffix

Mounting accessories see from page 200.

End Fitting Options:

- Eye A8 max. force 3,000 N
- Stud Thread B8
- Angle Ball Joint C8 max. force 1,200 N
- Clevis Fork D8 max. force 3,000 N
- Swivel Eye E8 max. force 3,000 N
- Ball Socket G8 max. force 1,200 N

Rod Shroud W8-28

Ø 32
 L = Stroke + 40

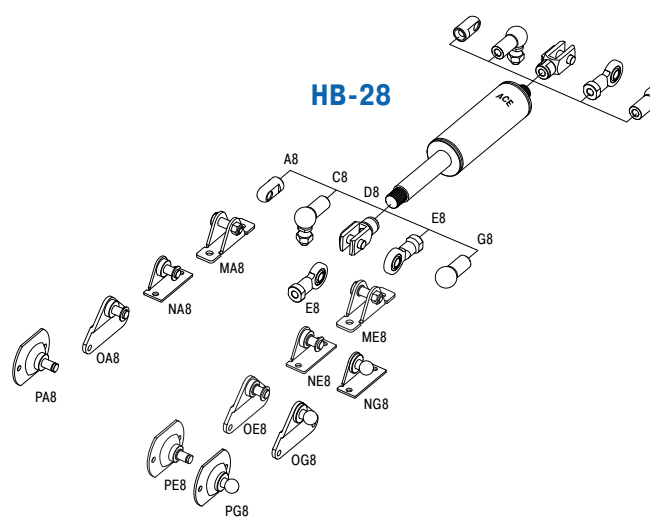

Technical Data

Compression and extension force: 30 N to 3,000 N

Free travel: Construction of the damper results in a free travel of approx. 20 % of stroke.

Separator piston: Extension force 80 N; dimension L = 2.35 x stroke + 60 mm. Part number: add suffix -T.

Operating temperature range: -20 °C to +80 °C

Adjustment: Achieved by turning the piston rod in its fully extended or fully compressed position.

Clockwise rotation = increase of the damping

Anti-clockwise rotation = decrease of the damping

Damping force adjustable before installation. Adjustment can add a max. of 6 mm to the L dimension.

Positive stop: External positive stops 1 mm to 1.5 mm before the end of stroke provided by the customer.

Material: Outer body: coated steel; Piston rod: steel with wear-resistant coating; End fittings: zinc plated steel

Mounting: in any position

Note: Increased break-away force if unit has not moved for some time.

End fittings: They are interchangeable and if necessary must be positively secured by the customer to prevent unscrewing.

Adjustable, Compression and extension force 30 N to 10,000 N

End Fitting
Standard Dimensions
End Fitting
A14

Eye A14
max. force 10,000 N

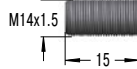
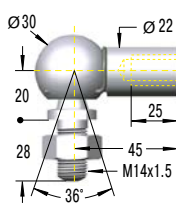
B14

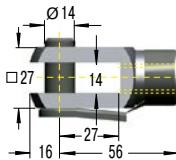
Stud Thread B14
C14

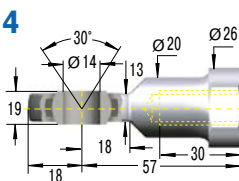
Angle Ball Joint C14
max. force 3,200 N

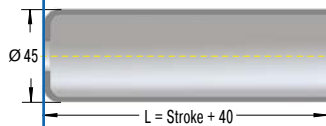
D14

Clevis Fork D14
max. force 10,000 N

E14

Swivel Eye E14
max. force 10,000 N

Rod Shroud W14-40

Performance and Dimensions

TYPES	Stroke mm	L extended mm	¹ Compression force max. N
HB-40-100	100	275	10,000
HB-40-150	150	375	10,000
HB-40-200	200	475	10,000
HB-40-300	300	675	10,000
HB-40-400	400	875	8,000
HB-40-500	500	1,075	6,000
HB-40-600	600	1,275	4,000
HB-40-700	700	1,475	3,000
HB-40-800	800	1,675	3,000

¹ Max. extension force for all stroke lengths 10,000 N.

Ordering Example

Type (Hydraulic Damper) → **HB-40-300-EE-N**
 Body Ø (40 mm) →
 Stroke (300 mm) →
 Piston Rod End Fitting E14 →
 Body End Fitting E14 →
 Damping Direction (N = in stroke only) →

Model Type Prefix

P: Damping in both directions
 N: Damping on in stroke only
 M: Damping on out stroke only
 X: Special model suffix

Mounting accessories see from page 200.
Technical Data
Compression and extension force: 30 N to 10,000 N

Free travel: Construction of the damper results in a free travel of approx. 20 % of stroke.

Separator piston: Extension force 150 N; dimension L = 2.32 x stroke + 82 mm. Part number: add suffix -T.

Operating temperature range: -20 °C to +80 °C

Adjustment: Achieved by turning the piston rod in its fully extended or fully compressed position.

Clockwise rotation = increase of the damping

Anti-clockwise rotation = decrease of the damping

Damping force adjustable before installation. Adjustment can add a max. of 6 mm to the L dimension.

Positive stop: External positive stops 1 mm to 1.5 mm before the end of stroke provided by the customer.

Material: Outer body: coated steel; Piston rod: steel with wear-resistant coating; End fittings: zinc plated steel

Mounting: in any position

Note: Increased break-away force if unit has not moved for some time.

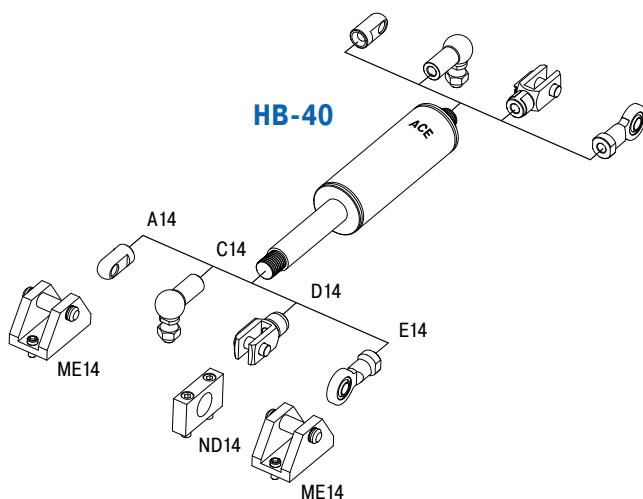
End fittings: They are interchangeable and if necessary must be positively secured by the customer to prevent unscrewing.

Adjustable, Compression and extension force 2,000 N to 50,000 N

End Fitting

Standard Dimensions

End Fitting

B24 Stud Thread **B24**

D24 Clevis Fork **D24**
max. force 50,000 N

E24 Swivel Eye **E24**
max. force 50,000 N

Performance and Dimensions

TYPES	Stroke mm	L extended mm	¹ Compression force max. N
HB-70-100	111	331	50,000
HB-70-200	211	531	50,000
HB-70-300	311	731	50,000
HB-70-400	411	931	30,300
HB-70-500	511	1,131	21,600
HB-70-600	611	1,331	16,200
HB-70-700	711	1,531	12,600
HB-70-800	811	1,731	10,100

¹ Max. extension force for all stroke lengths 50,000 N.

Ordering Example

HB-70-300-EE-N

Type (Hydraulic Damper) _____
 Body Ø (70 mm) _____
 Stroke (300 mm) _____
 Piston Rod End Fitting E24 _____
 Body End Fitting E24 _____
 Damping Direction (N = in stroke only) _____

Model Type Prefix

P: Damping in both directions
 N: Damping on in stroke only
 M: Damping on out stroke only
 X: Special model suffix

Mounting accessories see from page 200.

Rod Shroud W24-70

Ø 80
L = Stroke + 130

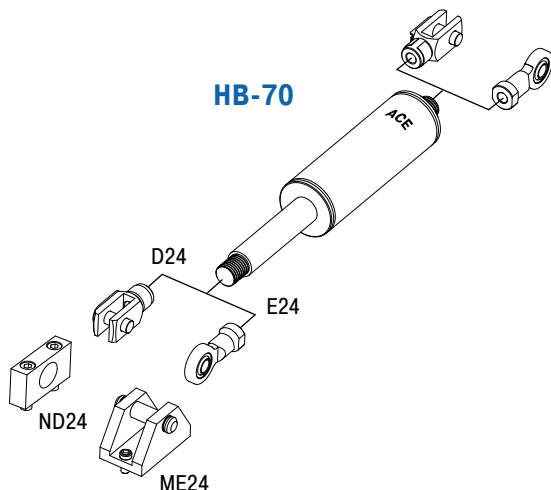

Technical Data

- Compression and extension force:** 2,000 N to 50,000 N
- Free travel:** Construction of the damper results in a free travel of approx. 20 % of stroke.
- Separator piston:** Extension force min. 250 N; dimension L + 150 mm. Part number: add suffix -T.
- Operating temperature range:** -20 °C to +80 °C
- Adjustment:** Achieved by turning the piston rod in its fully extended or fully compressed position.
 Clockwise rotation = increase of the damping
 Anti-clockwise rotation = decrease of the damping
 Damping force adjustable before installation. The adjustment can add a max. of 5 mm to the L dimension.
- Positive stop:** External positive stops 5 mm to 6 mm before the end of stroke provided by the customer.
- Material:** Outer body: coated steel; Piston rod: hard chrome plated steel; End fittings: zinc plated steel
- Mounting:** in any position
- Note:** Increased break-away force if unit has not moved for some time.
- End fittings:** They are interchangeable and if necessary must be positively secured by the customer to prevent unscrewing.

Locate and Eliminate Disturbing Vibration

Vibration isolation

- Free App for iPhone
- Precise 3-axis measurement system
- Simple & comprehensible menu
- Immediate product recommendation
- Available in English, German and French

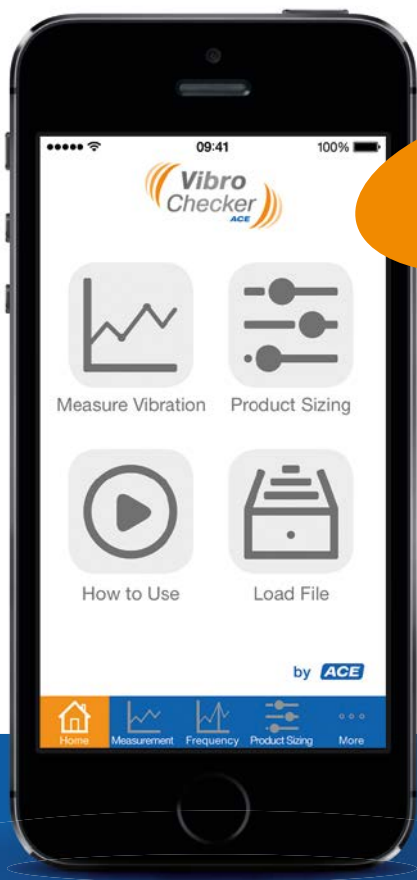

free in the
App Store

Start now.
Free App!



www.vibrochecker.com

TD, TDE

The safe way to close doors

Adjustable

Energy capacity 75 Nm/Cycle to 190 Nm/Cycle

Stroke 50 mm to 120 mm

Safety for individuals, doors and frames: whether acting single-sided or double-sided, ACE TD-28 and TDE-28 dampers securely prevent doors of all types and many weight classes from slamming shut. This is because the energy for stroke lengths between 50 mm and 120 mm is absorbed so reliably, that people and their possessions are protected.

The desired attenuation force is set manually; as a result, this door damper can absorb energy up to max. 190 Nm/stroke. Impact masses up to a maximum of 7,000 kg can be overcome depending on which type. ACE door dampers are manufactured to be high quality and durable with hard chrome-plated piston rod and galvanised steel cylinder tubes.

Practical and safe, these door dampers are suitable for manual or automatically operated hinged and sliding doors, as is often seen in the elevator and furniture industries, as well as in building technology.



Technical Data

Outer body diameter: Ø 28 mm

Piston rod diameter: Ø 8 mm

Free travel: TDE: marginal

Operating temperature range: -20 °C to +80 °C

Adjustment: Pull the piston rod fully out and turn the knurled rod end button. The internal toothed adjustment allows the damping to be separately adjusted for each side. As a result of the adjustment mechanism the overall length L can be increased by up to 4 mm (TDE-28) or 8 mm (TD-28).

Material: Outer body: zinc plated steel; Piston rod: hard chrome plated steel

Impact velocity range: 0.1 m/s to 2 m/s

Strokes per minute: max. 10

Application field: lift doors, automatic doors, doors

Note: ACE door dampers are single ended or double ended adjustable hydraulic shock absorbers.

On request: Special oils, other special options and special accessories are available on request.

TD-28

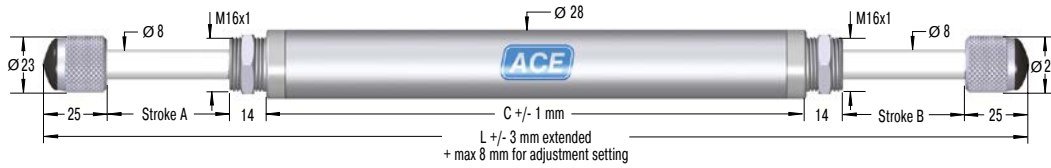

MB-16 Clamp Mount

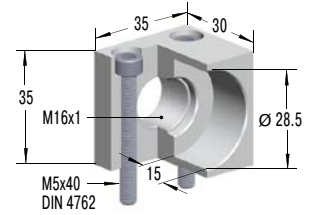

Model Type Prefix

F: Automatic return with return spring
 D: Without return spring. When one piston is pushed in, the piston rod at the other end is pushed out (thus the damper must be impacted from alternate ends to sequence correctly).

Ordering Example

Type (Door Damper) _____
 Body Ø (28 mm) _____
 Stroke A (50 mm) _____
 Stroke B (50 mm) _____

TD-28-50-50

Performance and Dimensions

TYPES	Energy capacity Nm/cycle	Reacting Force N	Impact Mass max. kg	Stroke A mm	Stroke B mm	C mm	L extended mm	Return Force max. N	¹ Return Type
TD-28-50-50-F	75	1,550	150	50	50	220	402	30	F
TD-28-70-70-F	70	1,500	200	70	70	260	482	30	F
TD-28-100-100-F	80	1,500	250	100	100	220	502	40	F
TD-28-120-120-D	165	3,800	250	120	120	208	417	-	D

¹ Standard model. Other models available on request.

TDE-28

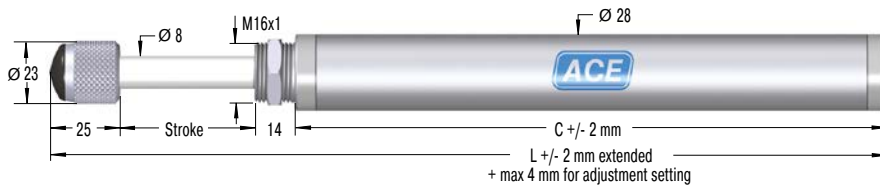

MB-16 Clamp Mount

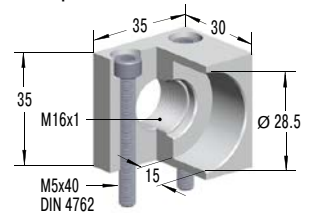

Ordering Example

Type (Door Damper) _____
 Body Ø (28 mm) _____
 Stroke (50 mm) _____

TDE-28-50

Performance and Dimensions

TYPES	Energy capacity Nm/cycle	Reacting Force N	Impact Mass max. kg	Stroke mm	C mm	L extended mm	Return Force max. N
TDE-28-50	80	2,400	4,000	50	130	219	30
TDE-28-70	112	2,400	5,600	70	158	267	30
TDE-28-100	160	2,400	8,000	100	193	332	30
TDE-28-120	190	2,400	7,000	120	214	371	40

Application Examples

DVC-32

Precise unreeling

Hydraulic dampers bring the sled movement of this textile machine to a gentle stop. At the turning point of 130 kg reeling spools, a sled should move up and down smoothly without causing a collision at the end of stroke position. The solution was provided by the hydraulic damper DVC-32-100EU. A self-contained sealed unit, ready to install and maintenance-free these units are ideal for precise control of speeds in both directions of travel. The travel speed is maintained throughout the entire stroke and can be independently adjusted in each direction of travel. Thanks to their compact design and wide choice of mounting accessories, these dampers could be easily integrated into this machine.

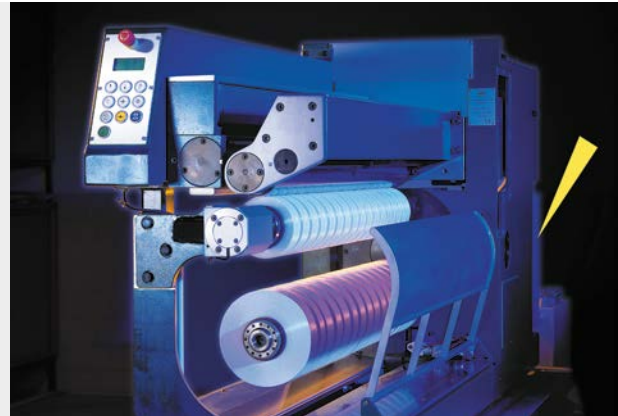

Textile machine unreels threads even better

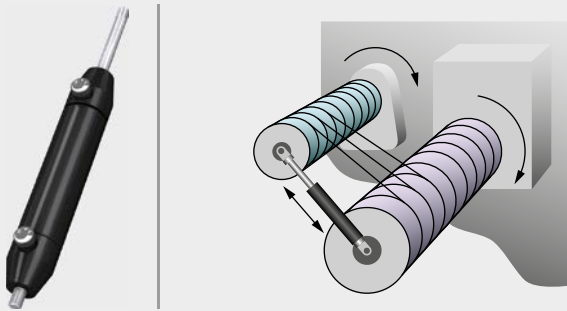

HB-15

Operating speed of flaps top-regulated

In the past, operators of used-clothes containers could sustain injury because the flaps closed relatively quickly and uncontrollably. Various hydraulic dampers of the type HB-15, which are designed specifically for the type of container, regulate the synchronization of the flap in both directions and thereby serve to regulate the operating speed. To accommodate a range of requirements and to provide optimal protection against theft, different types with different strokes are mounted on flaps without damping, on large flaps with damping and on rotor flaps with damping.



Hydraulic dampers prevent fingers becoming trapped in used-clothes containers as they ensure more gentle opening and closing movements
MCB Milieu & Techniek BV, 4704 SE Roosendaal, Netherlands

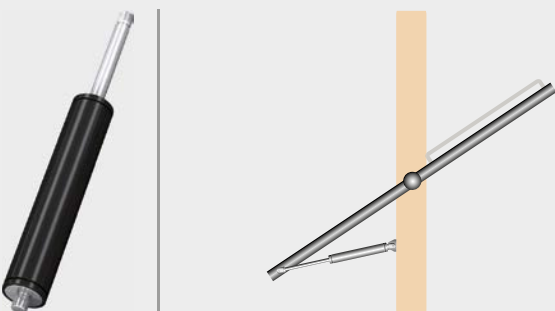

HB-40

Swinging movements cushioned by hydraulic dampers

Passengers always feel the swinging movement involved when cable cars arrive at the ski station. Maintenance-free hydraulic dampers type HB-40-300-EE-X-P cushion these movements perfectly. Designers of the cable cars, connected by means of an articulated joint via a four-point frame and connection guide to the suspension rod, profit from the ability of the adjustable dampers to absorb compressive forces of up to 10,000 N on either side.



Hydraulic dampers for added convenience when operating cable cars

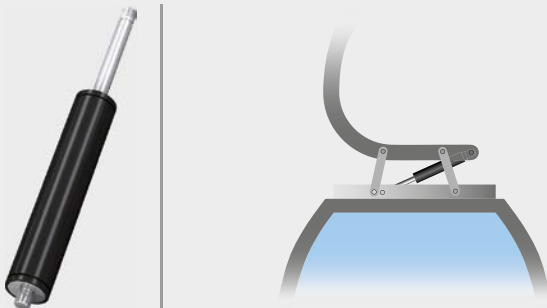

Mounting Accessories

for gas springs and hydraulic dampers
made of steel

By taking advantage of the very extensive range of ACE end fittings and mounting brackets you can easily and simply install our gas springs and hydraulic dampers. You profit from the variety of DIN Standard end fittings such as swivel eyes, clevis forks, angle ball joints, inline ball joints, and complementary ball sockets.

ACE also offers eye fittings made of wear-resistant steel to meet the higher specification requirements found in industrial applications. With over 30 different types available these mounting accessories provide an extensive range of combinations for optimum installations.

With the ACE selection programme you can choose not only your ACE gas springs but also the ideal end fittings and mounting brackets for your individual application example.

The complete range of accessories are also available as individual components.

**Individual
Combinations!**



M3.5x0.6

(for GS-8, GS-10, GS-12, GZ-15, HB-12)

C3,5
Angle Ball Joint
DIN 71802

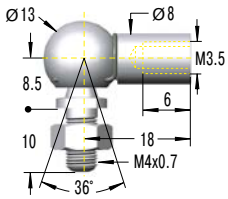

¹ max. force 370 N

E3,5
Swivel Eye
DIN 648

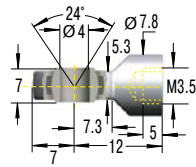

¹ max. force 370 N

A3,5
Eye

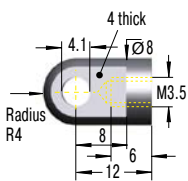

¹ max. force 370 N



NA3,5
Angle Bracket with Ball

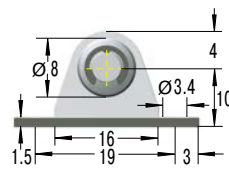

¹ max. force 180 N

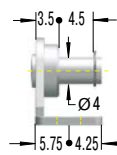

OA3,5
Side Bracket with Ball

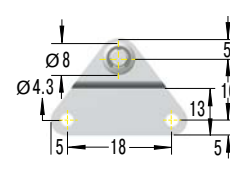

¹ max. force 180 N

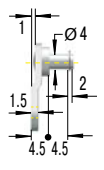

D3,5
Clevis Fork
DIN 71752

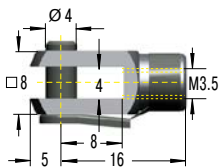

¹ max. force 370 N



A3,5
Eye

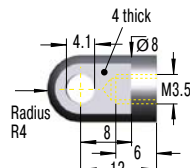

¹ max. force 370 N

G3,5
Ball Socket
DIN 71805

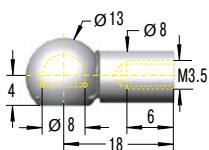

¹ max. force 370 N



NG3,5
Angle Bracket with Ball

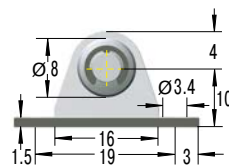

¹ max. force 180 N

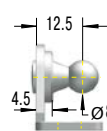

OG3,5
Side Bracket with Ball

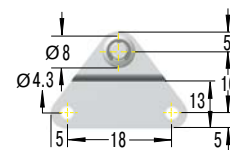

¹ max. force 180 N

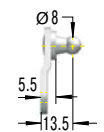

¹Attention! Max. static load in Newtons. Beware force increase during compression (progression) and observe max. force limit.

M5x0.8

(for GS-15, HB-15)

C5
Angle Ball Joint
DIN 71802

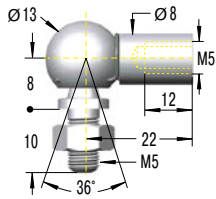

¹ max. force 500 N

D5
Clevis Fork
DIN 71752

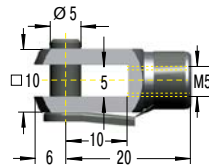

¹ max. force 800 N

F5
Inline Ball Joint

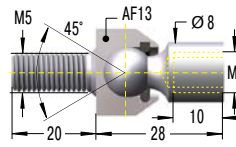

¹ max. force 500 N
Attention! Must only be used with compression loads!

A5
Eye

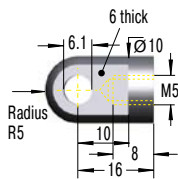

¹ max. force 800 N

MA5
Bearing Shoe

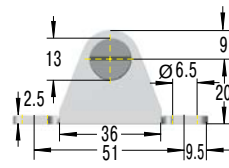

¹ max. force 500 N

NA5
Angle Bracket with Ball

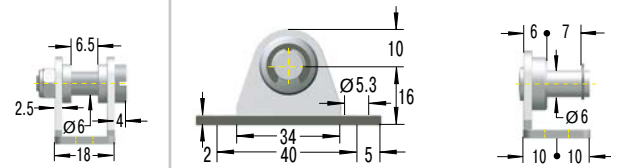

¹ max. force 400 N

E5
Swivel Eye
DIN 648

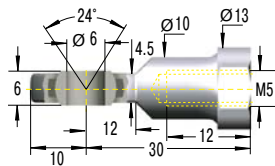

¹ max. force 800 N

OA5
Side Bracket with Ball

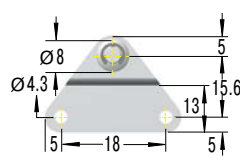

¹ max. force 180 N

PA5
Round Bracket with Ball

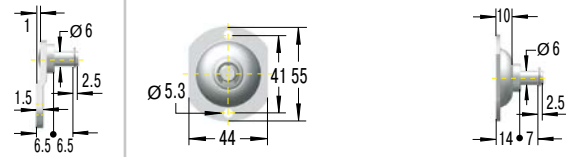

¹ max. force 500 N

G5
Ball Socket
DIN 71805

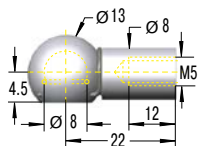

¹ max. force 500 N

NG5
Angle Bracket with Ball

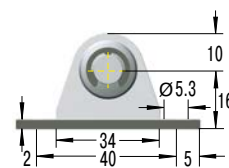

¹ max. force 400 N

OG5
Side Bracket with Ball

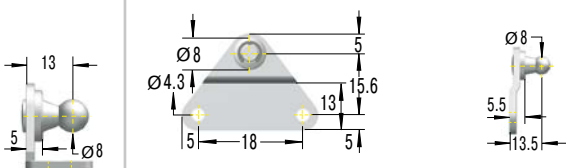

¹ max. force 180 N

PG5
Round Bracket with Ball

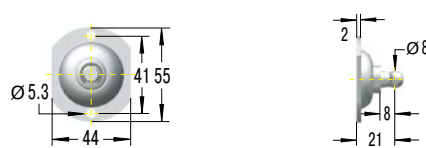

¹ max. force 500 N

¹Attention! Max. static load in Newtons. Beware force increase during compression (progression) and observe max. force limit.

M8x1.25

(for GS-19, GS-22, GZ-19, HB-22, HB-28, HBS-28, DVC-32)

C8 Angle Ball Joint DIN 71802

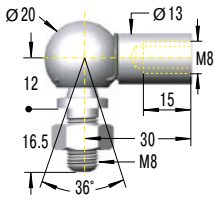

¹ max. force 1,200 N

F8 Inline Ball Joint

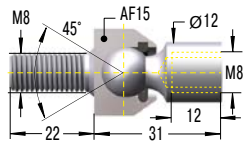

¹ max. force 1,200 N
Attention! Must only be used with compression loads!

A8 Eye

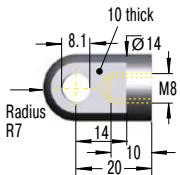

¹ max. force 3,000 N

MA8 Bearing Shoe

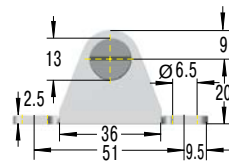

¹ max. force 1,800 N

NA8 Angle Bracket with Ball

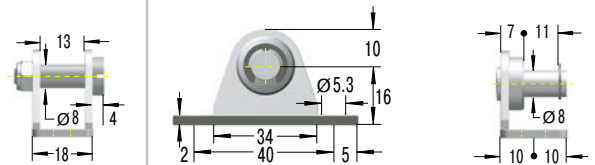

¹ max. force 1,000 N

OA8 Side Bracket with Ball

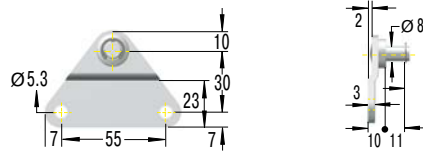

¹ max. force 1,200 N

PA8 Round Bracket with Ball

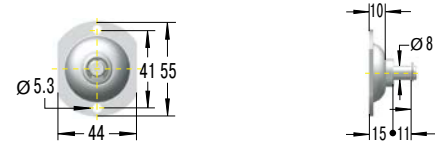

¹ max. force 1,200 N

D8 Clevis Fork DIN 71752

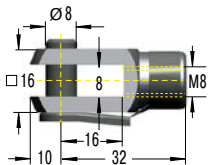

¹ max. force 3,000 N

E8 Swivel Eye DIN 648

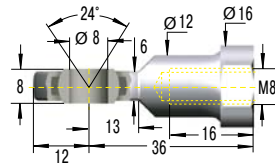

¹ max. force 3,000 N

¹ Attention! Max. static load in Newtons. Beware force increase during compression (progression) and observe max. force limit.

M8x1.25

(for GS-19, GS-22, GZ-19, HB-22, HB-28, HBS-28, DVC-32)

E8
Swivel Eye
DIN 648

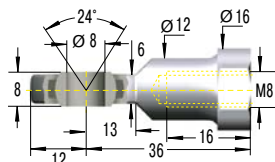

¹ max. force 3,000 N



ME8
Bearing Shoe

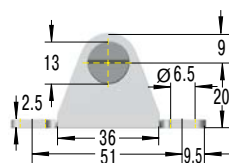

¹ max. force 1,800 N

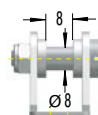

NE8
Angle Bracket with Ball

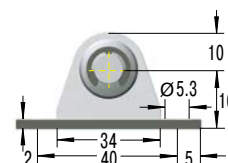

¹ max. force 1,000 N

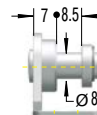

OE8
Side Bracket with Ball

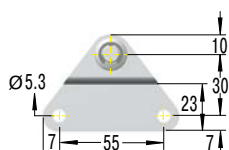

¹ max. force 1,200 N

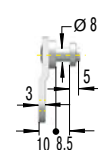

PE8
Round Bracket with Ball

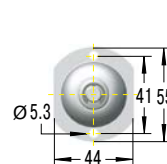

¹ max. force 1,200 N

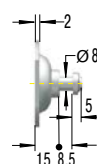

G8
Ball Socket
DIN 71805

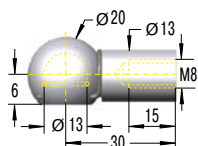

¹ max. force 1,200 N



NG8
Angle Bracket with Ball

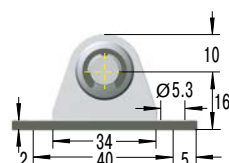

¹ max. force 1,000 N

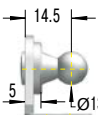

OG8
Side Bracket with Ball

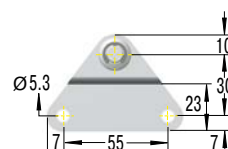

¹ max. force 1,200 N



PG8
Round Bracket with Ball

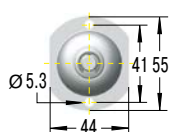

¹ max. force 1,200 N

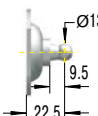

¹Attention! Max. static load in Newtons. Beware force increase during compression (progression) and observe max. force limit.

M10x1.5 (for GS-28, GZ-28, HBD-50, HBS-35)

C10
Angle Ball Joint
DIN 71802

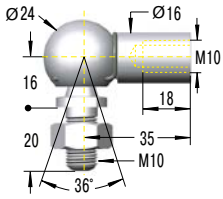

¹ max. force 1,800 N

F10
Inline Ball Joint

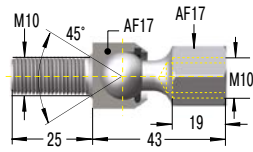

¹ max. force 1,800 N
Attention! Must only be used with compression loads!

A10
Eye

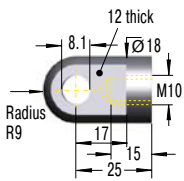

¹ max. force 10,000 N

MA10
Bearing Shoe

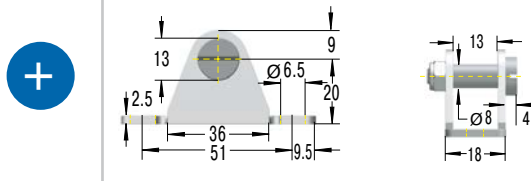

¹ max. force 1,800 N

D10
Clevis Fork
DIN 71752

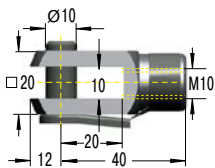

¹ max. force 10,000 N

E10
Swivel Eye
DIN 648

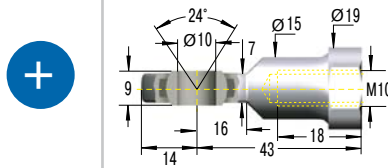

¹ max. force 10,000 N

E10
Swivel Eye
DIN 648

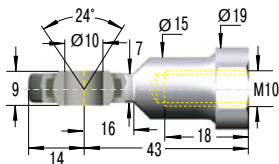

¹ max. force 10,000 N

ME10
Bearing Shoe

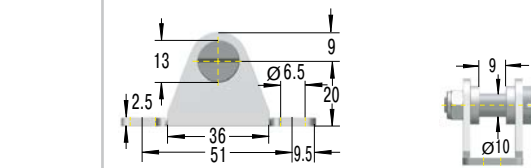

¹ max. force 1,800 N

OE10
Side Bracket with Ball

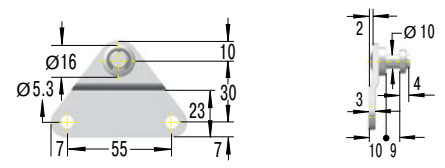

¹ max. force 1,200 N

PE10
Round Bracket with Ball

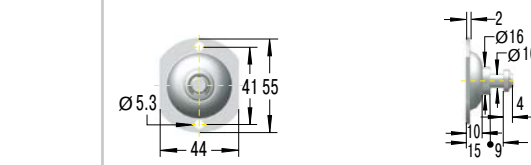

¹ max. force 1,200 N

Issue 07.2017 – Specifications subject to change

¹Attention! Max. static load in Newtons. Beware force increase during compression (progression) and observe max. force limit.

M14x1.5 (for GS-40, GST-40, GZ-40, HB-40, HBD-70)

C14
Angle Ball Joint
DIN 71802

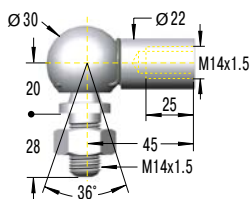

¹ max. force 3,200 N

F14
Inline Ball Joint

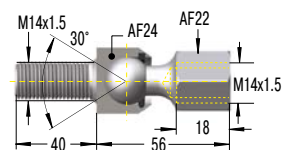

¹ max. force 3,200 N
Attention! Must only be used with compression loads!

A14
Eye

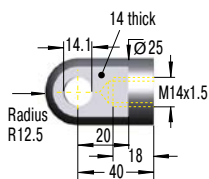

¹ max. force 10,000 N

ME14
Bearing Shoe

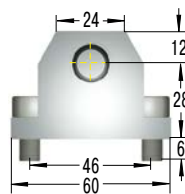

¹ max. force 10,000 N

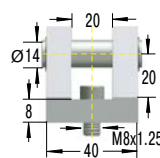

D14
Clevis Fork
DIN 71752

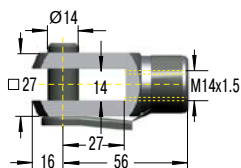

¹ max. force 10,000 N

ND14
Mounting Flange

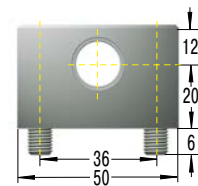

¹ max. force 10,000 N

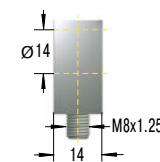

E14
Swivel Eye
DIN 648

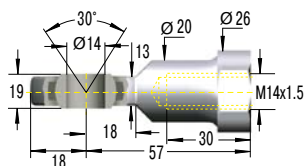

¹ max. force 10,000 N

ME14
Bearing Shoe

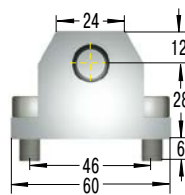

¹ max. force 10,000 N

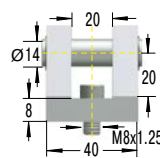

¹ Attention! Max. static load in Newtons. Beware force increase during compression (progression) and observe max. force limit.

M24x2

(for GS-70, HB-70, HBD-85, HBS-70)

D24 Clevis Fork DIN 71752

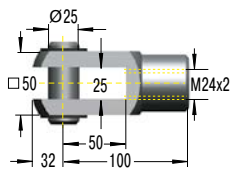

¹ max. force 50,000 N



ND24 Mounting Flange

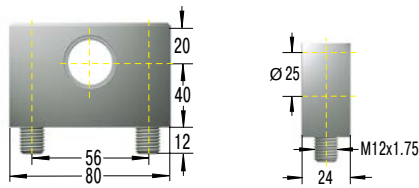

¹ max. force 50,000 N

E24 Swivel Eye DIN 648

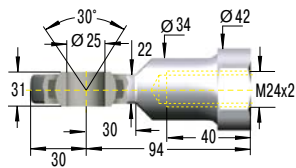

¹ max. force 50,000 N



ME24 Bearing Shoe

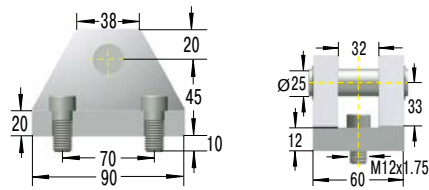

¹ max. force 50,000 N

¹Attention! Max. static load in Newtons. Beware force increase during compression (progression) and observe max. force limit.

Mounting Accessories

for gas springs and hydraulic dampers made of stainless steel

For our gas springs and hydraulic dampers made of stainless steel we also offer a flexible product range of DIN standardised end fittings and mounting brackets. These eyes, swivel eyes, clevis forks, angle ball joints, ball sockets, inline ball joints and mounting brackets are also made of sturdy stainless steel and can be flexibly combined.

The high-quality stainless steel accessories are rustproof and weakly magnetic. Just as with the corresponding stainless steel gas springs and hydraulic dampers, they are preferred in the food, electronics and ship building industries along with medical and cleanroom technology.

All ACE stainless steel gas springs and the appropriate mounting accessories are individually designed for each application with the ACE calculation program.

The entire range of stainless steel accessories is also available separately.

**Individual
Combinations!**

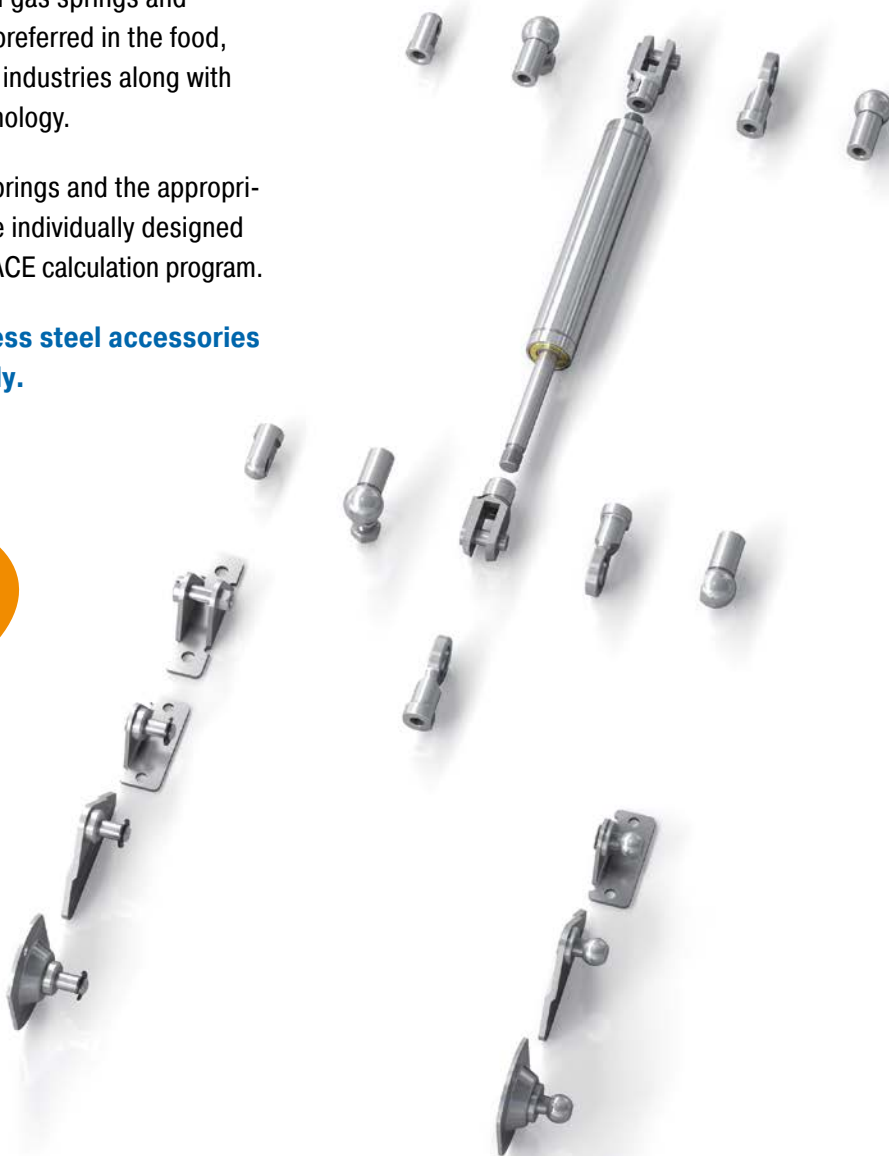

M3.5x0.6

(for GS-8-V4A, GS-10-V4A, GS-12-V4A, GZ-15-V4A)

C3,5-V4A

Angle Ball Joint

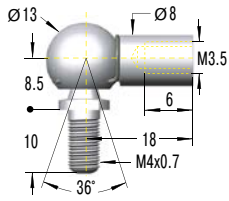

¹ max. force 370 N

A3,5-V4A

Eye

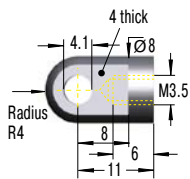

¹ max. force 370 N



NA3,5-V4A

Angle Bracket with Ball

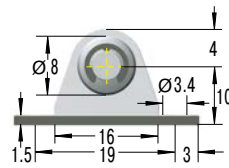

¹ max. force 180 N

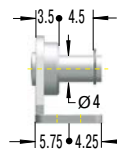

OA3,5-V4A

Side Bracket with Ball

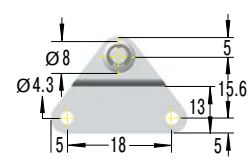

¹ max. force 180 N

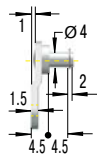

D3,5-V4A

Clevis Fork

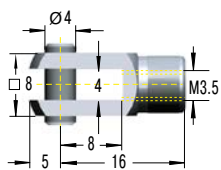

¹ max. force 370 N



A3,5-V4A

Eye

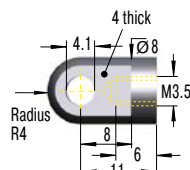

¹ max. force 370 N

G3,5-V4A

Ball Socket

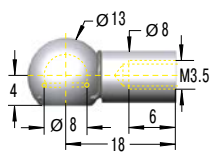

¹ max. force 370 N



NG3,5-V4A

Angle Bracket with Ball

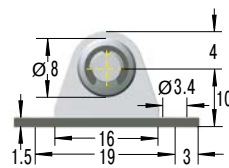

¹ max. force 180 N

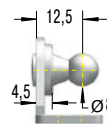

OG3,5-V4A

Side Bracket with Ball

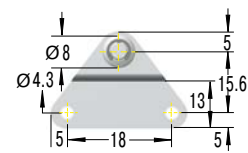

¹ max. force 180 N

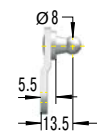

¹Attention! Max. static load in Newtons. Beware force increase during compression (progression) and observe max. force limit.

M5x0.8 (for GS-15-VA)

C5-VA
Angle Ball Joint

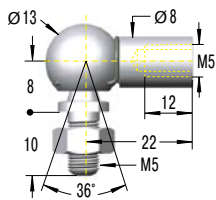

¹ max. force 430 N

D5-VA
Clevis Fork

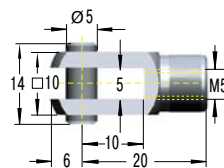

¹ max. force 490 N

E5-VA
Swivel Eye

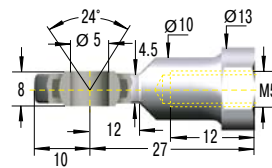

¹ max. force 490 N

A5-VA
Eye

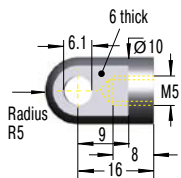

¹ max. force 490 N

MA5-V4A
Bearing Shoe

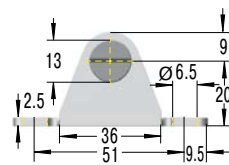

¹ max. force 500 N

NA5-V4A
Angle Bracket with Ball

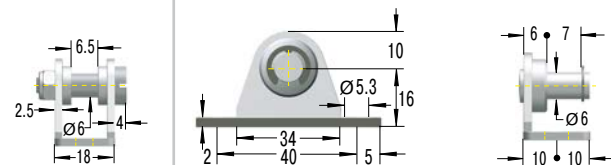

¹ max. force 400 N



OA5-V4A
Side Bracket with Ball

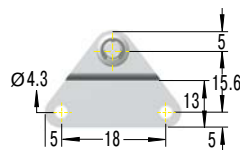

¹ max. force 180 N

PA5-V4A
Round Bracket with Ball

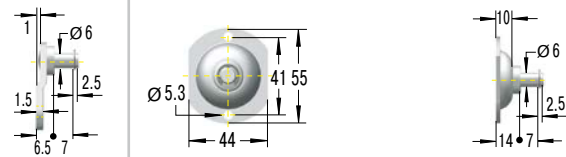

¹ max. force 500 N

G5-VA
Ball Socket

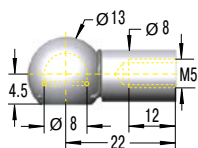

¹ max. force 430 N

NG5-V4A
Angle Bracket with Ball

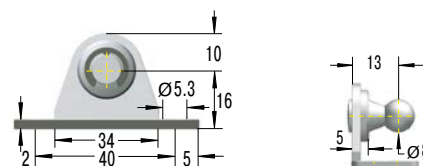

¹ max. force 400 N

OG5-V4A
Side Bracket with Ball

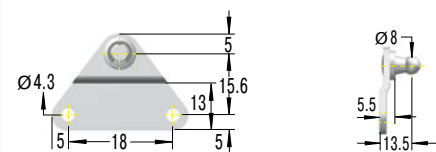

¹ max. force 180 N



PG5-V4A
Round Bracket with Ball

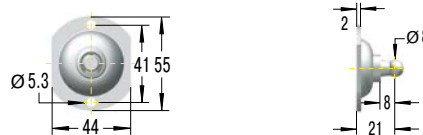

¹ max. force 500 N

¹Attention! Max. static load in Newtons. Beware force increase during compression (progression) and observe max. force limit.

M8x1.25

(for GS-19-VA, GS-22-VA, GZ-19-VA)

C8-VA Angle Ball Joint

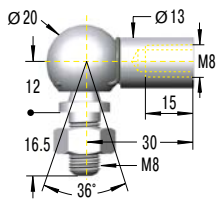

¹ max. force 1,140 N

D8-VA Clevis Fork

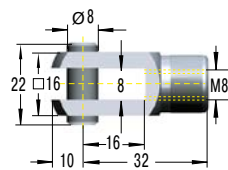

¹ max. force 1,560 N

A8-VA Eye

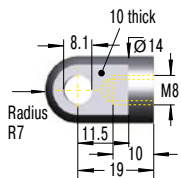

¹ max. force 1,560 N

MA8-V4A Bearing Shoe

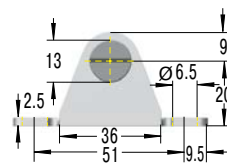

¹ max. force 1,800 N

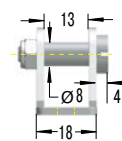

NA8-V4A Angle Bracket with Ball

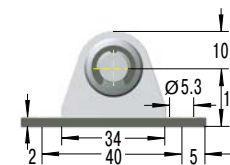

¹ max. force 1.000 N

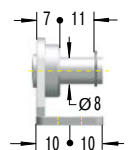

OA8-V4A Side Bracket with Ball

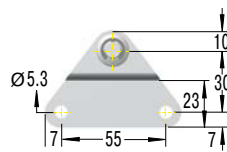

¹ max. force 1,200 N

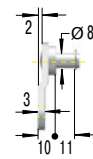

PA8-V4A Round Bracket with Ball

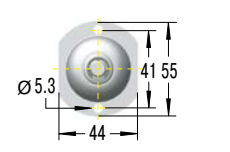

¹ max. force 1,200 N

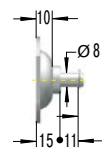

E8-VA Swivel Eye

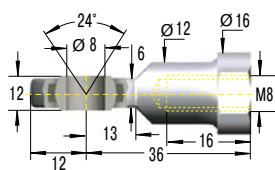

¹ max. force 1,560 N



MA8-V4A Bearing Shoe

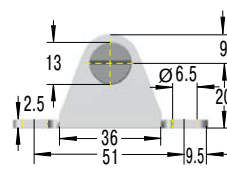

¹ max. force 1,800 N

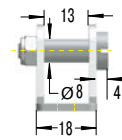

¹Attention! Max. static load in Newtons. Beware force increase during compression (progression) and observe max. force limit.

M8x1.25 (for GS-19-VA, GS-22-VA, GZ-19-VA)

G8-VA
Ball Socket

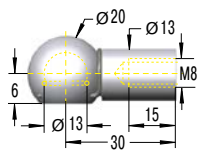

¹ max. force 1,140 N

NG8-V4A
Angle Bracket with Ball

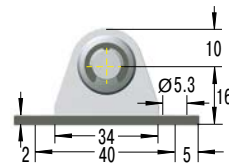

¹ max. force 1,000 N

OG8-V4A
Side Bracket with Ball

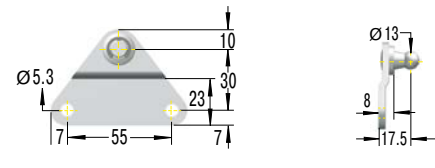

¹ max. force 1,200 N



PG8-V4A
Round Bracket with Ball

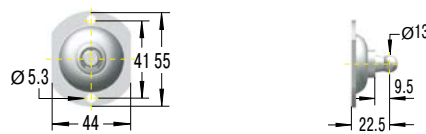

¹ max. force 1,200 N

M10x1.5 (for GS-28-VA, GZ-28-VA)

C10-VA
Angle Ball Joint

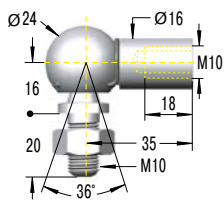

¹ max. force 1,750 N

D10-VA
Clevis Fork

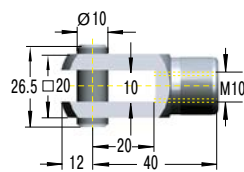

¹ max. force 3,800 N

E10-VA
Swivel Eye

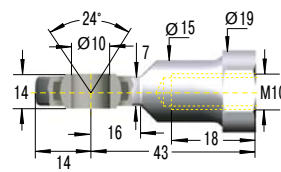

¹ max. force 3,800 N

A10-VA
Eye

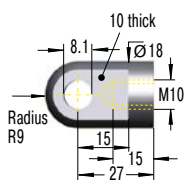

¹ max. force 3,800 N



MA10-V4A
Bearing Shoe

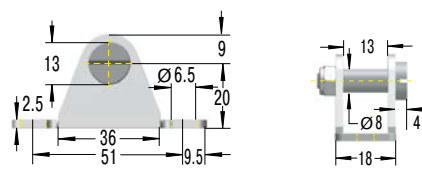

¹ max. force 1,800 N

¹Attention! Max. static load in Newtons. Beware force increase during compression (progression) and observe max. force limit.

M14x1.5 (for GS-40-VA, GZ-40-VA)

C14-VA Angle Ball Joint

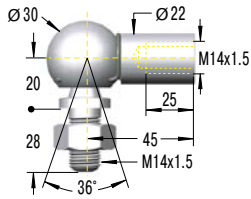

¹ max. force 3,200 N

A14-VA Eye

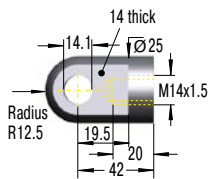

¹ max. force 7,000 N



ME14-VA Bearing Shoe

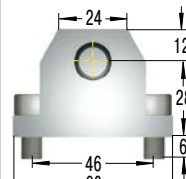

¹ max. force 10,000 N

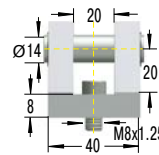

D14-VA Clevis Fork

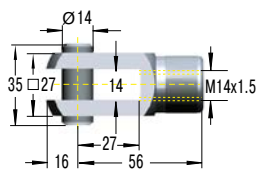

¹ max. force 7,000 N



ND14-VA Mounting Flange

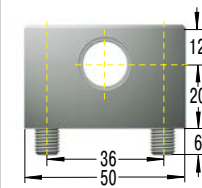

¹ max. force 10,000 N

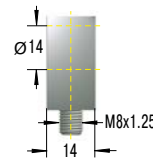

E14-VA Swivel Eye

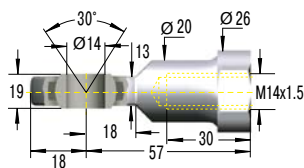

¹ max. force 7,000 N



ME14-VA Bearing Shoe

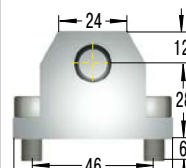

¹ max. force 10,000 N

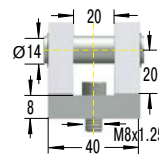

¹ Attention! Max. static load in Newtons. Beware force increase during compression (progression) and observe max. force limit.

Hydraulic Feed Controls

Regulate feed rates in the best way

Hydraulic feed controls from ACE are recommended as the perfect solution e.g. when sawing, cutting, drilling and in order to prevent the stick-slip effect on pneumatic cylinders, amongst others. They can be precisely adjusted and provide speeds from 12 mm/min. with a very low feed force or up to 38 m/min. with a high feed rate.

The maintenance-free, ready-to-install hydraulic feed controls are self-contained, hydraulic elements regulated by a precision throttle. The feed rate is set from the outside by turning the setting adjuster. The tried-and-testing rolling diaphragms used in many ACE shock absorbers also serve as a dynamic sealing element for a hermetic seal as well as volume compensation for the piston rod and resetting element.



Hydraulic Feed Controls



VC25

Adjustable

For precision adjustment of feed rates

Handling modules, Linear slides, Automatic machinery,
Conveyor equipment

Page 216



MA, MVC

Adjustable

Designed for applications with low precision requirements

Handling modules, Linear slides, Automatic machinery,
Conveyor equipment

Page 218

Shorter processing times

Different feed rates

Adjustment segment at the lower end of the feed control

Most accurate calibrations

Available immediately

Easy to mount



VC25

For precision adjustment of feed rates

Adjustable

Compression force 30 N to 3,500 N

Stroke 15 mm to 125 mm

Precise adjustment for any type of application: Hydraulic feed controls of the product family VC are ideally suited for the precise tuning of constant feed rates. The thread of the outer body of this closed hydraulic element allows simple assembly. Designs with a smooth body can also be supplied.

As the hydraulic oil is forced out through the throttle opening, a constant feed rate is achieved on the stroke. In the models up to 55 mm stroke, the tried and tested rolling diaphragm, known from ACE shock absorbers, serves as a dynamic seal, as volume compensation of the piston rod and as a reset element.

Precision hydraulic feed controls of the product family VC are used in automotive and industrial applications as well as in automation and machine building and electronics industries.

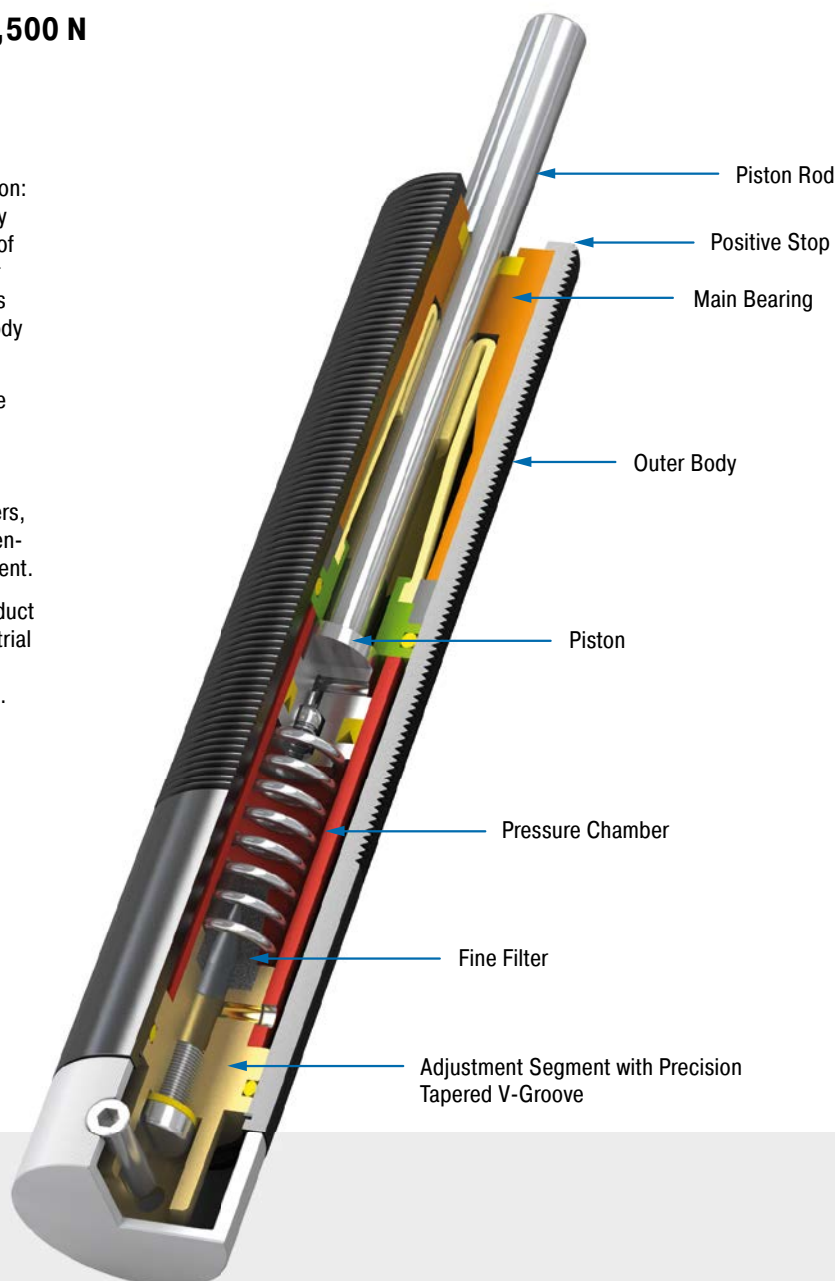

Technical Data

Compression force: 30 N to 3,500 N

Execution: F = \varnothing 23.8 mm without thread
FT = M25x1.5 threaded body

Piston rod diameter: \varnothing 8 mm

Feed rate/Compression force:
Min. 0.013 m/min. at 400 N; Max. 38 m/min. at 3,500 N

Impact velocity range: At speeds of 0.3 m/s the maximum allowed energy is approx. 1 Nm for units up to 55 mm stroke and approx. 2 Nm for units 75 mm to 125 mm stroke. Where higher energies occur use a shock absorber for the initial impact. Avoid high impact velocities.

Adjustment: Infinitely adjustable

Positive stop: External positive stops 1 mm to 1.5 mm before the end of stroke provided by the customer.

Damping medium: Oil, temperature stable

Material: Outer body: Black anodized aluminium; Piston rod: Hard chrome plated steel; Accessories: Steel with black oxide finish or nitride hardened

Mounting: In any position

Operating temperature range: 0 °C to 60 °C

Application field: Handling modules, Linear slides, Automatic machinery, Conveyor equipment, Absorption control

Note: Nylon button PP600 can be fitted onto piston rod. Unit may be mounted in any position.

Safety instructions: Do not rotate piston rod, if excessive rotation force is applied rolling seal may rupture. External materials in the surrounding area can attack the seal components and lead to a shorter service life. Please contact ACE for appropriate solution suggestions.

On request: Special oil and other special options available on request.

VC25EUFT

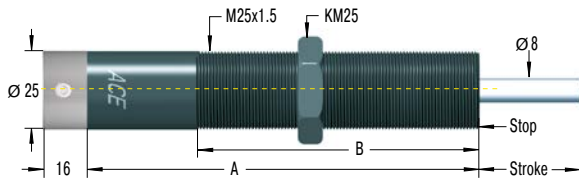

SP25

Air Bleed Collar

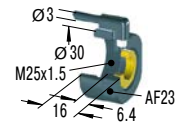

For VC2515FT to VC2555FT
reduction of the stroke 6.4 mm

MB25

Clamp Mount

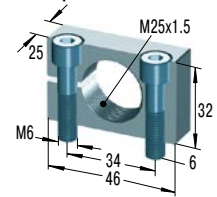

Additional accessories, mounting, installation ... see from page 42.

Complete details required when ordering

Load to be decelerated: m (kg)
Impact velocity: v (m/s)
Propelling force: F (N)
Operating cycles per hour: c (/hr)
Number of absorbers in parallel: n
Ambient temperature: $^{\circ}\text{C}$

Ordering Example

Type (Feed Control) _____
Thread Size M25 _____
Stroke (55 mm) _____
EU Compliant _____
FT = with thread M25x1.5 _____
F = without thread, plain body (\varnothing 23.8 mm)

VC 25 55 EUFT

Performance and Dimensions

TYPES	Stroke mm	A mm	B mm	Compression force min. N	Compression force max. N	Return Force min. N	Return Force max. N	Return Time s	Side Load Angle max. °	Weight kg
VC2515EUFT	15	128	80	30	3,500	15	30	0.2	3	0.260
VC2530EUFT	30	161	110	30	3,500	5	30	0.4	2	0.470
VC2555EUFT	55	209	130	35	3,500	5	40	1.2	2	0.420
VC2575EUFT	75	283	150	50	3,500	10	50	1.7	2	0.701
VC25100EUFT	100	308	150	60	3,500	10	50	2.3	1	0.814
VC25125EUFT	125	333.5	150	70	3,500	10	60	2.8	1	0.928

Suffix FT: M25x1.5 threaded body.

Suffix F: plain body 23.8 mm dia. (without thread), with optional clamp type mounting block.

Operating Range VC

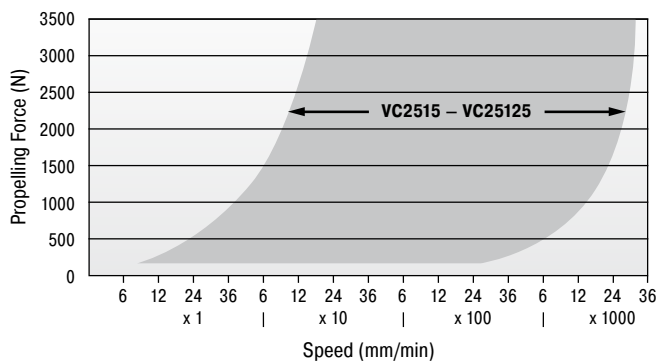

Accessories with Mounting Example



Mounting with clamp mount MB25



Installed with air bleed collar SP25

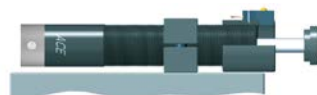

Installed with switch stop collar inc. proximity switch and steel button AS25 plus PS25

Alternative circlip grooves

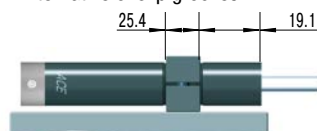

Bulkhead mounting for VC25...F with mounting block KB... (23.8 mm plain body option)

MA, MVC

Designed for applications with low precision requirements

Adjustable

Compression force 8 N to 3,500 N

Stroke 7 mm to 40 mm

Many application options: The hydraulic feed controls in models MA and MVC are similar to that of the VC model. However, these hydraulic controls have been designed for applications that require less precision.

There are also plenty of accessories for the MA and MVC models. All products are ready-to-install, maintenance-free, stable in temperature and avoids stick-slip effect. Speeds from 12 mm/min. can be driven at a low thrust force using the adjustment screw on the base of the hydraulic control.

Hydraulic feed controls with the designations MA and MVC are especially used in handling modules or linear carriages and also for applications with changing usage data.

Operating Range MVC225 to MVC900

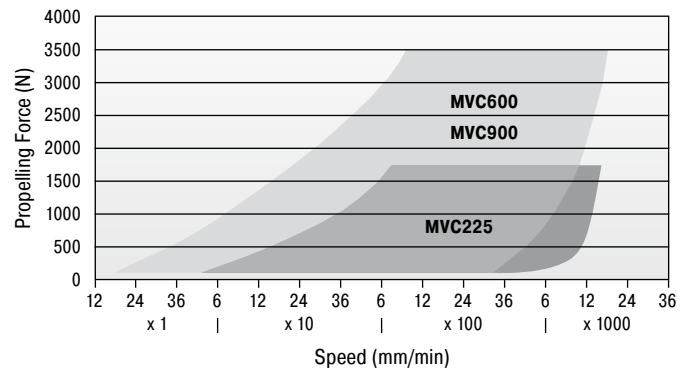

Performance and Dimensions

TYPES	Stroke mm	Compression force		Return Force min. N	Return Force max. N	Return Time s	Side Load Angle max. °	Weight kg
		min. N	max. N					
MA30EUM	8	8	80	1.7	5.3	0.3	2.0	0.011
MA50EUM-B	7.2	40	160	3.0	6.0	0.3	2.0	0.025
MA35EUM	10.2	15	200	5.0	11.0	0.2	2.0	0.045
MA150EUM	12.7	20	300	3.0	5.0	0.4	2.0	0.061
MVC225EUM	19	25	1,750	5.0	10.0	0.65	2.0	0.160
MVC600EUM	25	65	3,500	10.0	30.0	0.85	2.0	0.320
MVC900EUM	40	70	3,500	10.0	35.0	0.95	2.0	0.420

¹ For applications with higher side load angles consider using the side load adaptor (BV) pages 38 to 45.

Technical Data

Compression force: 8 N to 3,500 N

Execution: Thread M8 to M25

Impact velocity range: At speeds of 0.3 m/s the maximum allowed energy is approx. 2 Nm. Where higher energies occur use a shock absorber for the initial impact. Avoid high impact velocities.

Adjustment: Hard impact at the start of stroke, turn towards 9 or PLUS. Hard impact at the end of stroke, turn towards 0 or MINUS.

Positive stop: Integrated

Damping medium: Oil, temperature stable

Material: Outer body: Nitride hardened steel; Piston rod: Steel with black oxide finish or nitride hardened

Mounting: In any position

Operating temperature range: 0 °C to 66 °C

Application field: Handling modules, Linear slides, Automatic machinery, Conveyor equipment, Absorption control

Note: Damper is preset at delivery in a neutral position between hard and soft.

Safety instructions: External materials in the surrounding area can attack the seal components and lead to a shorter service life. Please

contact ACE for appropriate solution suggestions.

On request: Nickel-plated, weartec finish (seawater resistant) or other special options available on request.

MA30EUM

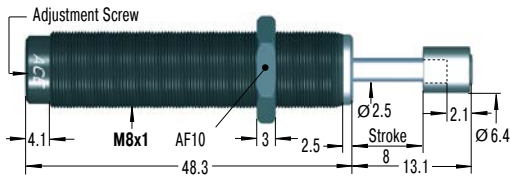

RF8 Rectangular Flange

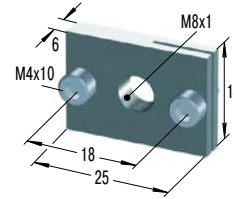

MB8SC2 Mounting Block

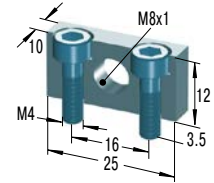

MA50EUM-B

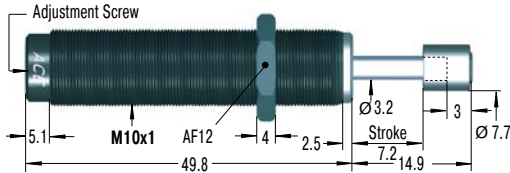

RF10 Rectangular Flange

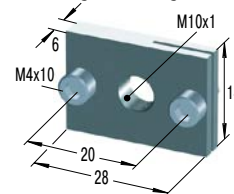

MB10SC2 Mounting Block

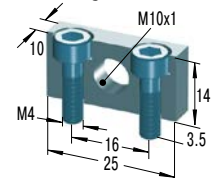

MA35EUM

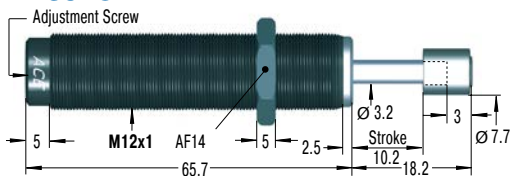

RF12 Rectangular Flange

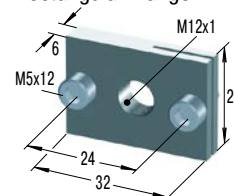

MB12 Clamp Mount

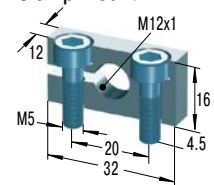

MA150EUM

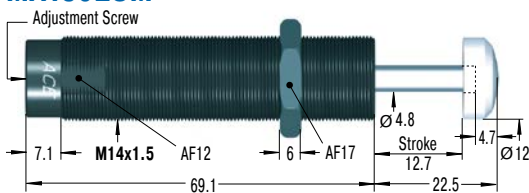

RF14 Rectangular Flange

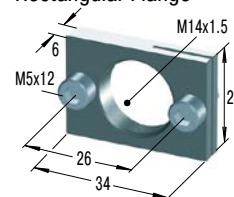

MB14 Clamp Mount

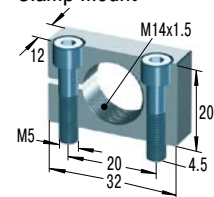

MVC225EUM

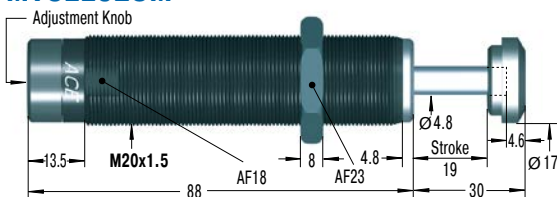

RF20 Rectangular Flange

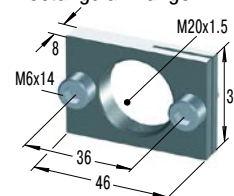

MB20 Clamp Mount

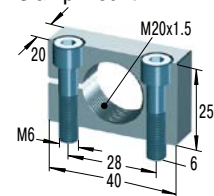

MVC600EUM

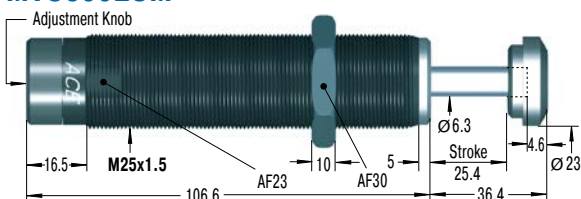

RF25 Rectangular Flange

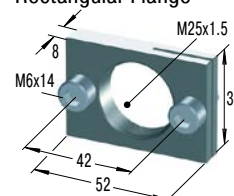

MB25 Clamp Mount

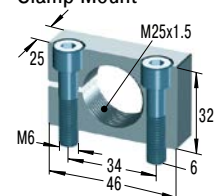

MVC900EUM

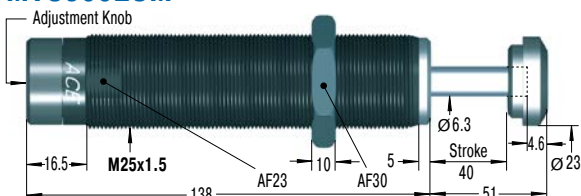

RF25 Rectangular Flange

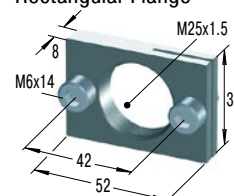

MB25 Clamp Mount

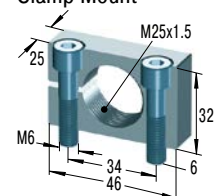

Additional accessories, mounting, installation ... see from page 38.

Rotary Dampers

Small dampers refine end product

ACE rotary dampers mainly provide an invisible yet valuable service as a maintenance-free machine element to allow controlled deceleration of rotary or linear movements.

They are often necessary to make careful opening and closing of small lids, compartments and drawers possible and they protect sensitive components while increasing the quality and value of products. They are easy to integrate. The harmoniously gentle movements of these little decelerators can be achieved with continual rotation or with limited pivoting angles. They slow down left, right or double sided rotation. Suitable for almost any application and currently also available in adjustable variations, they provide braking torques of 0.05 Ncm to 40 Nm.

Partial Rotation Angle, Adjustable
e.g. FYT-H1 and FYN-H1

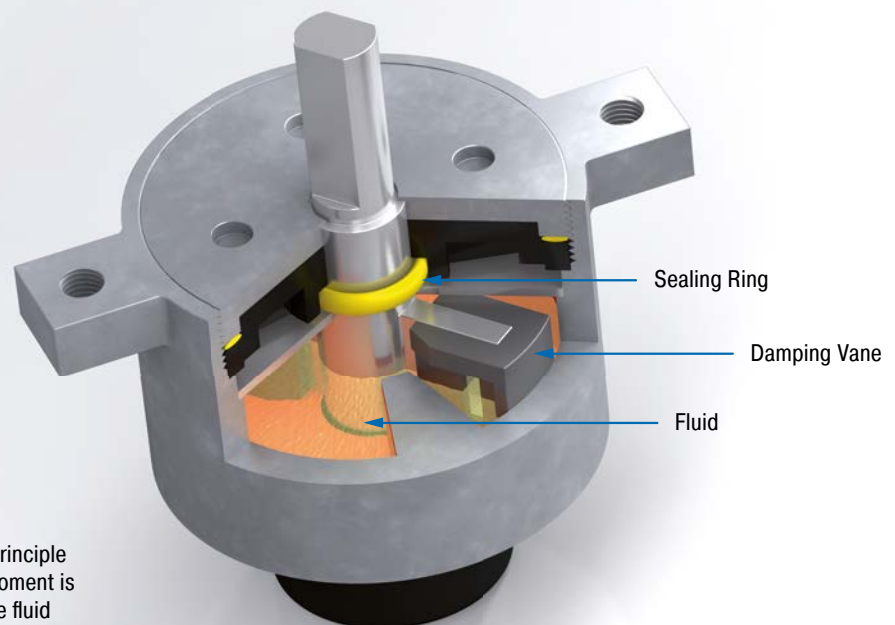

General Function

Rotary dampers operate on the principle of fluid damping. The damping moment is determined by the viscosity of the fluid and the dimensioning of the throttle gap or throttle orifices.



Rotary Dampers with Continuous Rotation

Rotate for the plus in quality: For smooth, quiet movements of small hoods, flaps and fans these continuously rotating rotary dampers from ACE decelerate either right, left or two-sided rotation right in the pivot point or linear through a gear and gear rack. The harmoniously gentle process protects components and increases the quality and value of products. The maintenance-free, ready-to-install ACE rotary dampers are filled with an inert fluid, usually silicone oil. The viscosity of the fluid and the sizing of the throttling gap determine the damping torque. The FFD series is the only exception: These fluid-free rotary dampers operate according to the principle of friction.

The continuously rotating rotary dampers with the designations FRT, FRN, FFD, FDT and FDN are used in household and medical devices as well as in the automotive, electronics and furniture industries.



Rotary Dampers with Partial Rotation Angle

For controlled and gentle deceleration: The damping direction of this rotary damper, which is available with adjustable damping torque, can be right, left or two-sided rotation. They can be installed directly in the pivot point of a construction and achieve uniform, quiet movements, which increases quality and value and protects sensitive components. The products are maintenance-free, ready-to-install and filled with an inert fluid, usually silicone oil. A rotor movement presses the fluid from one chamber into the other. The damping torque is determined by the viscosity of the fluid and the sizing of the throttling gap the throttle holes. During each reversal of movement, depending on the frame size a certain return damping torque develops.

These solutions are used in the automotive sector, in many industrial applications, in the electronics and furniture industries as well as in medical devices.

High protection of sensitive components

Various designs for every application

Maintenance-free and ready-to-install

Partial Rotation Angle

e.g. FYN-N1

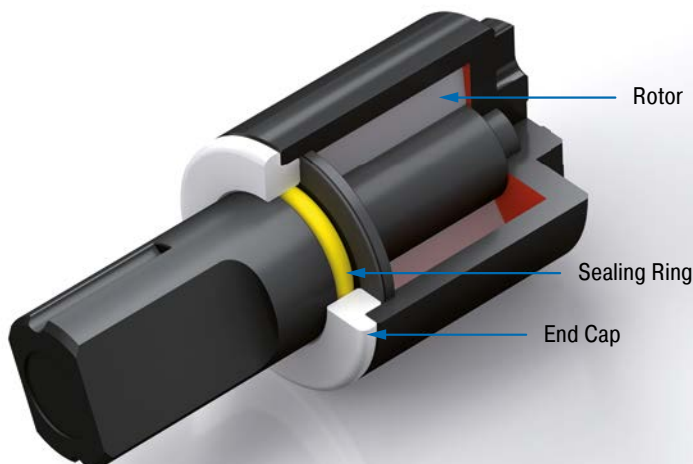

Continuous Rotation

e.g. FRT-E2

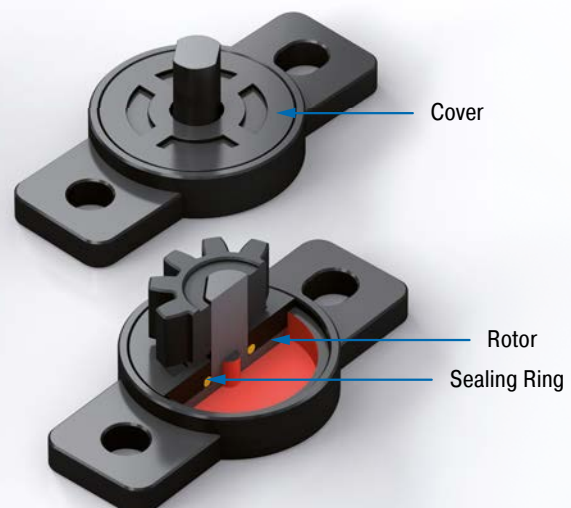



Rotary Dampers

kontinuierlich drehend



FRT-E2

Continuous Rotation
Small and lightweight for finest braking

Page 224



FRT-G2

Continuous Rotation
Small and lightweight for finest braking

Page 225



FRT-C2 and FRN-C2

Continuous Rotation
Flexible and cost efficient use

Page 226



FRT-D2 and FRN-D2

Continuous Rotation
Flexible and cost efficient use

Page 227



FRT-F2/K2 and FRN-F2/K2

Continuous Rotation
For very long service life extension

Page 228



FFD

Continuous Rotation
Precise braking without oil

Page 229



FDT

Continuous Rotation
The flat disc brake for two-sided damping

Page 230



FDN

Continuous Rotation
The flat disc brake for one direction of rotation

Page 231

Rotary Dampers



Partial rotation angle



FYN-P1

Page 232

Partial Rotation Angle
Small diameter, large damping torques



FYN-N1

Page 233

Partial Rotation Angle
Small diameter, large damping torques



FYN-U1

Page 234

Partial Rotation Angle
Small, strong and very robust



FYN-S1

Page 235

Partial Rotation Angle
The flat damper for constant component protection



Partial rotation angle, adjustable



FYT-H1 and FYN-H1

Page 236

Partial Rotation Angle, Adjustable
Specifically adjustable, strong braking force



FYT-LA3 and FYN-LA3

Page 237

Partial Rotation Angle, Adjustable
Adjustable high performance

FRT-E2

Small and lightweight for finest braking

Continuous Rotation

Damping torque 0.1 Ncm to 0.4 Ncm

The damping direction of the smallest ACE FRT-E2 rotary dampers with plastic body is rotating on both sides. They can brake directly in the pivot point or linear through a gear and gear rack. ACE rotary dampers are maintenance-free and ready-to-install.



Technical Data

Construction size: Ø 10 mm

Rotational speed max.: 50 rpm

Lifetime: 50,000 cycles (1 cycle = 360° left-hand, 360° right-hand). Even after this time, the dampers still produce over approx. 80 % of their original damping moment. The service life may be significantly higher or lower, depending on the application.

Operating temperature range: 0 °C to +50 °C

Pressure angle: 20°

Material: Outer body, Shaft, Gear: Plastic

Mounting: In any position

Tooth: Involute gearing

P.C.D.: 6 mm

No. of teeth: 10

Module: 0.6

Mounting information: No axial or radial forces may be induced via the shaft.

Safety instructions: Do not use rotary dampers as supports. Provide an external guide or support.

On request: Special designs available on request. Toothed plastic racks (modules 0.5 to 1.0) are available for the rotary dampers with pinions.

Characteristics

At 23 °C ambient temperature

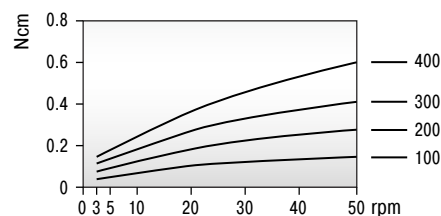

At 20 rpm rotational speed

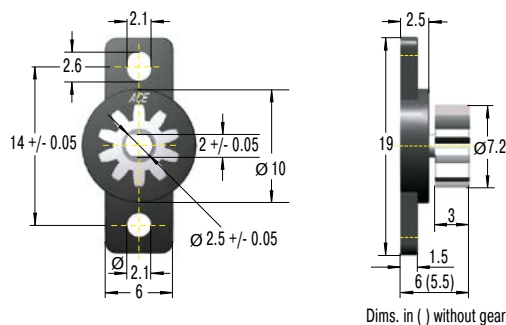
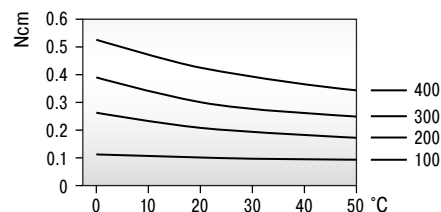

Performance

TYPES	¹ Damping torque Ncm	Damping direction	Gear	Weight kg
FRT-E2-100	0.10 +/- 0.05	bidirectional	without	0.00032
FRT-E2-200	0.20 +/- 0.07	bidirectional	without	0.00032
FRT-E2-300	0.30 +/- 0.08	bidirectional	without	0.00032
FRT-E2-400	0.40 +/- 0.10	bidirectional	without	0.00032
FRT-E2-100-G1	0.10 +/- 0.05	bidirectional	with	0.00041
FRT-E2-200-G1	0.20 +/- 0.07	bidirectional	with	0.00041
FRT-E2-300-G1	0.30 +/- 0.08	bidirectional	with	0.00041
FRT-E2-400-G1	0.40 +/- 0.10	bidirectional	with	0.00041

¹ The indicated damping torque refers to a rotational speed of 20 rpm and an ambient temperature of 23 °C.

FRT-G2

Small and lightweight for finest braking

Continuous Rotation

Damping torque 0.2 Ncm to 1 Ncm

The damping direction of the ACE FRT-G2 product family with plastic body is rotating on both sides. The small rotary dampers can brake directly in the pivot point or linear through a gear and gear rack. ACE rotary dampers are maintenance-free and ready-to-install.



Technical Data

Construction size: Ø 15 mm

Rotational speed max.: 50 rpm

Lifetime: 50,000 cycles (1 cycle = 360° left-hand, 360° right-hand). Even after this time, the dampers still produce over approx. 80 % of their original damping moment. The service life may be significantly higher or lower, depending on the application.

Operating temperature range: 0 °C to +50 °C

Pressure angle: 20°

Material: Outer body, Shaft, Gear: Plastic

Mounting: In any position

Tooth: Involute gearing

P.C.D.: 7 mm

No. of teeth: 14

Module: 0.5

Mounting information: No axial or radial forces may be induced via the shaft.

Safety instructions: Do not use rotary dampers as supports. Provide an external guide or support.

On request: Special designs available on request. Toothed plastic racks (modules 0.5 to 1.0) are available for the rotary dampers with pinions.

Characteristics

At 23 °C ambient temperature

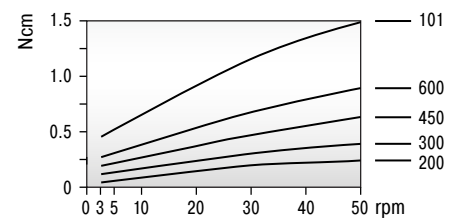

At 20 rpm rotational speed

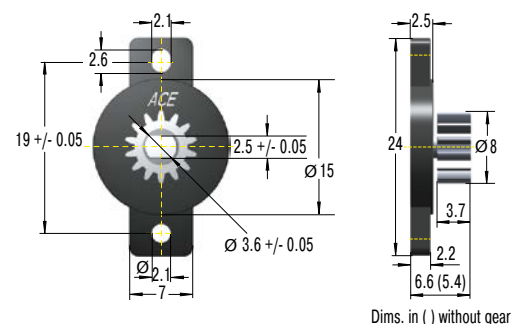
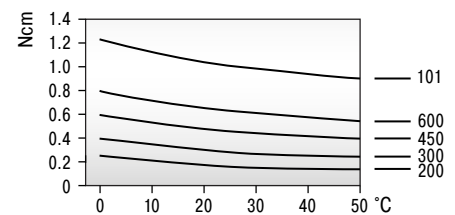

Performance

TYPES	¹ Damping torque Ncm	Damping direction	Gear	Weight kg
FRT-G2-200	0.20 +/- 0.07	bidirectional	without	0.00060
FRT-G2-300	0.30 +/- 0.08	bidirectional	without	0.00060
FRT-G2-450	0.45 +/- 0.10	bidirectional	without	0.00060
FRT-G2-600	0.60 +/- 0.12	bidirectional	without	0.00060
FRT-G2-101	1.00 +/- 0.20	bidirectional	without	0.00060
FRT-G2-200-G1	0.20 +/- 0.07	bidirectional	with	0.00080
FRT-G2-300-G1	0.30 +/- 0.08	bidirectional	with	0.00080
FRT-G2-450-G1	0.45 +/- 0.10	bidirectional	with	0.00080
FRT-G2-600-G1	0.60 +/- 0.12	bidirectional	with	0.00080
FRT-G2-101-G1	1.00 +/- 0.20	bidirectional	with	0.00080

¹ The indicated damping torque refers to a rotational speed of 20 rpm and an ambient temperature of 23 °C.

FRT-C2 and FRN-C2

Flexible and cost efficient use

Continuous Rotation

Damping torque 2 Ncm to 3 Ncm

The damping direction of the simple FRT-C2 and FRN-C2 is either right, left or two-sided rotation. These ACE rotary dampers with plastic body can decelerate directly in the pivot point or linear through a gear and gear rack. ACE rotary dampers are maintenance-free and ready-to-install.



Technical Data

Construction size: Ø 15 mm

Rotational speed max.: 50 rpm

Lifetime: 50,000 cycles (1 cycle = 360° left-hand, 360° right-hand). Even after this time, the dampers still produce over approx. 80 % of their original damping moment. The service life may be significantly higher or lower, depending on the application.

Operating temperature range: 0 °C to +50 °C

Pressure angle: 20°

Material: Outer body, Gear: Plastic; Shaft: Plastic, steel

Mounting: In any position

Tooth: Involute gearing

P.C.D.: 8.8 mm

No. of teeth: 11

Module: 0.8

Mounting information: No axial or radial forces may be induced via the shaft.

Safety instructions: Do not use rotary dampers as supports. Provide an external guide or support.

On request: Special designs available on request. Toothed plastic racks (modules 0.5 to 1.0) are available for the rotary dampers with pinions.

Characteristics

At 23 °C ambient temperature

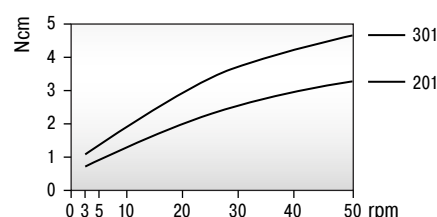

At 20 rpm rotational speed

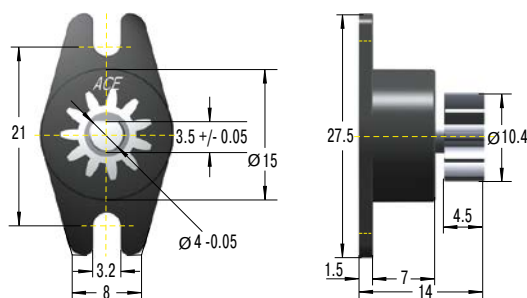
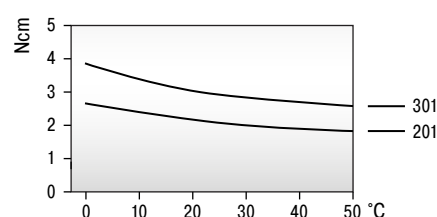

Performance

TYPES	¹ Damping torque Ncm	Damping direction	Gear	Weight kg
FRT-C2-201	2 +/- 0.6	bidirectional	without	0.002
FRT-C2-301	3 +/- 0.8	bidirectional	without	0.002
FRT-C2-201-G1	2 +/- 0.6	bidirectional	with	0.002
FRT-C2-301-G1	3 +/- 0.8	bidirectional	with	0.002
FRN-C2-R201	2 +/- 0.6	right	without	0.002
FRN-C2-R301	3 +/- 0.8	right	without	0.003
FRN-C2-R201-G1	2 +/- 0.6	right	with	0.002
FRN-C2-R301-G1	3 +/- 0.8	right	with	0.004
FRN-C2-L201	2 +/- 0.6	left	without	0.002
FRN-C2-L301	3 +/- 0.8	left	without	0.003
FRN-C2-L201-G1	2 +/- 0.6	left	with	0.002
FRN-C2-L301-G1	3 +/- 0.8	left	with	0.003

¹ The indicated damping torque refers to a rotational speed of 20 rpm and an ambient temperature of 23 °C.

FRT-D2 and FRN-D2

Flexible and cost efficient use

Continuous Rotation

Damping torque 5 Ncm to 15 Ncm

The damping direction of the ACE FRT-D2 and FRN-D2 rotary dampers with plastic body is either the right, left or two-sided rotation. They can decelerate directly in the pivot point or linear through a gear and gear rack. ACE rotary dampers are maintenance-free and ready-to-install.



Technical Data

Construction size: Ø 25 mm

Rotational speed max.: 50 rpm

Lifetime: 50,000 cycles (1 cycle = 360° left-hand, 360° right-hand). Even after this time, the dampers still produce over approx. 80 % of their original damping moment. The service life may be significantly higher or lower, depending on the application.

Operating temperature range: 0 °C to +50 °C

Pressure angle: 20°

Material: Outer body, Gear: Plastic; Shaft: Plastic, steel

Mounting: In any position

Tooth: Involute gearing (addendum modification coefficient: +0.375)

P.C.D.: 12 mm

No. of teeth: 12

Module: 1

Mounting information: No axial or radial forces may be induced via the shaft.

Safety instructions: Do not use rotary dampers as supports. Provide an external guide or support.

On request: Special designs available on request. Toothed plastic racks (modules 0.5 to 1.0) are available for the rotary dampers with pinions.

Characteristics

At 23 °C ambient temperature

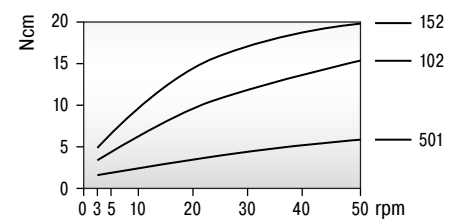

At 20 rpm rotational speed

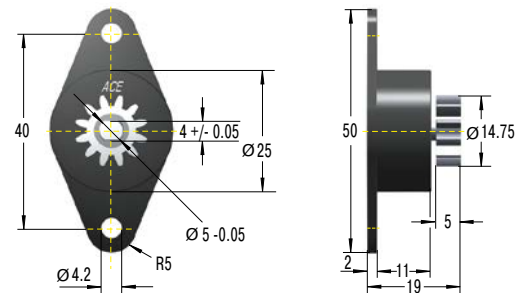
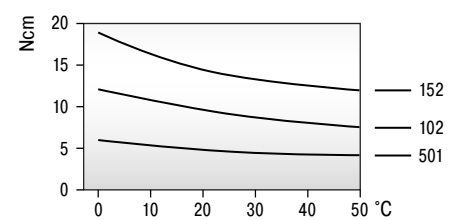

Performance

TYPES	¹ Damping torque Ncm	Damping direction	Gear	Weight kg
FRT-D2-102	10 +/- 2	bidirectional	without	0.008
FRT-D2-152	15 +/- 3	bidirectional	without	0.008
FRT-D2-501	5 +/- 1	bidirectional	without	0.008
FRT-D2-102-G1	10 +/- 2	bidirectional	with	0.009
FRT-D2-152-G1	15 +/- 3	bidirectional	with	0.009
FRT-D2-501-G1	5 +/- 1	bidirectional	with	0.009
FRN-D2-R102	10 +/- 2	right	without	0.012
FRN-D2-R152	15 +/- 3	right	without	0.012
FRN-D2-R501	5 +/- 1	right	without	0.012
FRN-D2-R102-G1	10 +/- 2	right	with	0.012
FRN-D2-R152-G1	15 +/- 3	right	with	0.012
FRN-D2-R501-G1	5 +/- 1	right	with	0.012
FRN-D2-L102	10 +/- 2	left	without	0.012
FRN-D2-L152	15 +/- 3	left	without	0.012
FRN-D2-L501	5 +/- 1	left	without	0.012
FRN-D2-L102-G1	10 +/- 2	left	with	0.012
FRN-D2-L152-G1	15 +/- 3	left	with	0.012
FRN-D2-L501-G1	5 +/- 1	left	with	0.012

¹ The indicated damping torque refers to a rotational speed of 20 rpm and an ambient temperature of 23 °C.

FRT-F2/K2 and FRN-F2/K2

For very long service life extension

Continuous Rotation

Damping torque 200 Ncm to 400 Ncm

The damping direction of FRT F2/K2 and FRN-F2/K2 is either the right, left or two-sided rotation. With a damping torque of up to 400 Ncm, this product family can even handle heavy components. These ACE rotary dampers can decelerate directly in the pivot point or linear through a gear and gear rack. They are maintenance-free and ready-to-install.



Technical Data

Construction size: Ø 40 mm

Rotational speed max.: 50 rpm

Lifetime: 50,000 cycles (1 cycle = 360° left-hand, 360° right-hand). Even after this time, the dampers still produce over approx. 80 % of their original damping moment. The service life may be significantly higher or lower, depending on the application.

Operating temperature range: 0 °C to +50 °C

Material: Outer body: Plastic; Shaft: Steel

Mounting: In any position

Mounting information: No axial or radial forces may be induced via the shaft.

Safety instructions: Do not use rotary dampers as supports. Provide an external guide or support.

On request: Special designs available on request.

Characteristics

At 23 °C ambient temperature

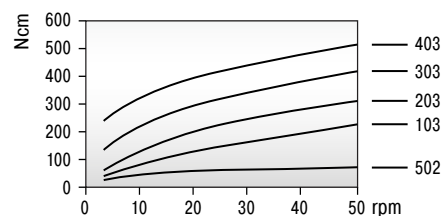

At 20 rpm rotational speed

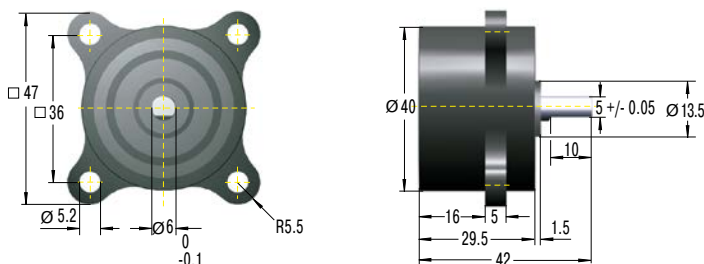
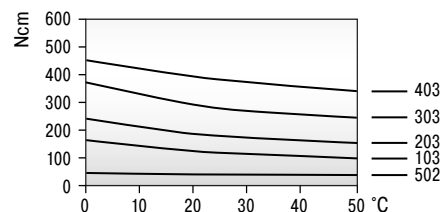

Performance

TYPES	¹ Damping torque Ncm	Damping direction	Weight kg
FRT-K2-502	50 +/- 10	bidirectional	0.080
FRT-K2-103	100 +/- 20	bidirectional	0.080
FRT-F2-203	200 +/- 40	bidirectional	0.115
FRT-F2-303	300 +/- 80	bidirectional	0.115
FRT-F2-403	400 +/- 100	bidirectional	0.115
FRN-K2-R502	50 +/- 10	right	0.057
FRN-K2-R103	100 +/- 20	right	0.057
FRN-F2-R203	200 +/- 40	right	0.090
FRN-K2-L502	50 +/- 10	left	0.057
FRN-K2-L103	100 +/- 20	left	0.057
FRN-F2-L203	200 +/- 40	left	0.090

¹ The indicated damping torque refers to a rotational speed of 20 rpm and an ambient temperature of 23 °C.

Issue 07.2017 – Specifications subject to change

FFD

Precise braking without oil

Continuous Rotation

Damping torque 0.1 Nm to 3 Nm

In comparison to other rotary dampers, the ACE FFD product family does not need any fluid to generate the damping torque, but rather works on the principle of friction. That means temperature or speed changes have virtually no influence on the damping torque. The FFD is available in two different body variants and two types of bearings. ACE rotary dampers are maintenance-free and ready-to-install.



Technical Data

Construction size: Ø 25 mm to 30 mm

Rotational speed max.: 30 rpm

Lifetime: 30,000 cycles (1 cycle = 360° left-hand, 360° right-hand). Even after this time, the dampers still produce over approx. 80 % of their original damping moment. The service life may be significantly higher or lower, depending on the application.

Operating temperature range: -10 °C to +60 °C

Material: Outer body: Plastic

Mounting: In any position

Information to the shaft: Ø +0 / -0.03

Hardness > HRC55, surface smoothness RZ<1µm

Mounting information: Turn the shaft in the opposite direction to the brake direction to avoid damaging the freewheel mount. No axial or radial forces may be induced via the shaft.

Safety instructions: Do not use rotary dampers as supports. Provide an external guide or support.

On request: Special designs available on request.

Ordering Example

Friction Damper _____
 Body Ø _____
 Mounting Style (flange = F, standard = S) _____
 Model (standard = S, high = W) _____
 Damping Direction (right = R, left = L) _____
 Damping Torque see chart _____

FFD-25-FS-L-102

Complete details required when ordering

Damping torque 102 = 0.1 Nm
 Damping torque 502 = 0.5 Nm
 Damping torque 103 = 1.0 Nm
 Damping torque 153 = 1.5 Nm
 Damping torque 203 = 2.0 Nm
 Damping torque 253 = 2.5 Nm
 Damping torque 303 = 3.0 Nm
 Note dimension C.

Model Type Prefix

FS = Mounting Style with Flange, Model standard

FW = Mounting Style with Flange, Model high

SS = Mounting Style Standard, Model standard

SW = Mounting Style Standard, Model high

Combinations with W for higher damping torque.

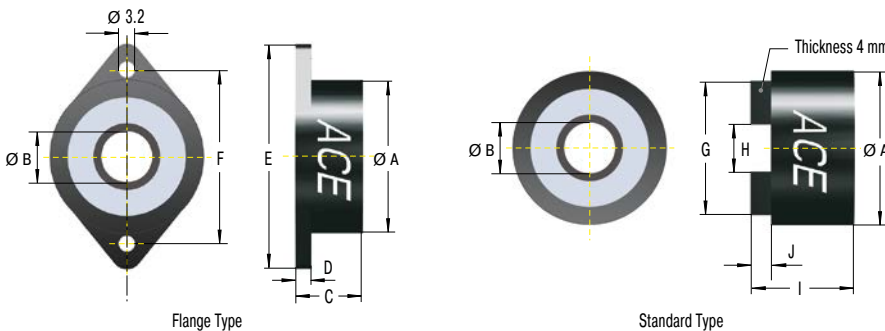

Performance and Dimensions

TYPES	¹ Damping torque Nm	Damping direction	Model	A mm	B mm	C mm	D mm	E mm	F mm	G mm	H mm	I mm	J mm	Weight kg
FFD-25SS	0.1/0.5/1.0	right or left	SS	25	6	13	3	42	34	21	6.2	16	4	0.012
FFD-28SS	0.1/0.5/1.0	right or left	SS	28	8	13	3	44	36	24	8.2	16	4	0.014
FFD-30SS	0.1/0.5/1.0/1.5	right or left	SS	30	10	13	3	46	38	26	10.2	16	4	0.016
FFD-25FS	0.1/0.5/1.0	right or left	FS	25	6	13	3	42	34	21	6.2	16	4	0.013
FFD-28FS	0.1/0.5/1.0	right or left	FS	28	8	13	3	44	36	24	8.2	16	4	0.014
FFD-30FS	0.1/0.5/1.0/1.5	right or left	FS	30	10	13	3	46	38	26	10.2	16	4	0.017
FFD-25SW	1.0/1.5/2.0	right or left	SW	25	6	19	3	42	34	21	6.2	22	4	0.023
FFD-28SW	1.0/1.5/2.0	right or left	SW	28	8	19	3	44	36	24	8.2	22	4	0.025
FFD-30SW	1.5/2.0/2.5/3.0	right or left	SW	30	10	19	3	46	38	26	10.2	22	4	0.030
FFD-25FW	1.0/1.5/2.0	right or left	FW	25	6	19	3	42	34	21	6.2	22	4	0.024
FFD-28FW	1.0/1.5/2.0	right or left	FW	28	8	19	3	44	36	24	8.2	22	4	0.027
FFD-30FW	1.5/2.0/2.5/3.0	right or left	FW	30	10	19	3	46	38	26	10.2	22	4	0.031

¹ The indicated damping torque refers to a rotational speed of 20 rpm and an ambient temperature of 23 °C.

FDT

The flat disc brake for two-sided damping

Continuous Rotation

Damping torque 2 Nm to 8.7 Nm

The damping direction of the flat constructive ACE rotary damper FDT with robust steel body is two-sided rotation. It can brake directly in the pivot point of the square receptacle. ACE rotary dampers are maintenance-free and ready-to-install.



Technical Data

Construction size: Ø 47 mm to 70 mm

Rotational speed max.: 50 rpm

Lifetime: 50,000 cycles (1 cycle = 360° left-hand, 360° right-hand). Even after this time, the dampers still produce over approx. 80 % of their original damping moment. The service life may be significantly higher or lower, depending on the application.

Operating temperature range: -10 °C to +50 °C

Material: Outer body: Steel; Output shaft sleeve: Nylon

Mounting: In any position

Mounting information: No axial or radial forces may be induced via the shaft.

Safety instructions: Do not use rotary dampers as supports. Provide an external guide or support.

On request: Special designs available on request.

Characteristics

At 23 °C ambient temperature

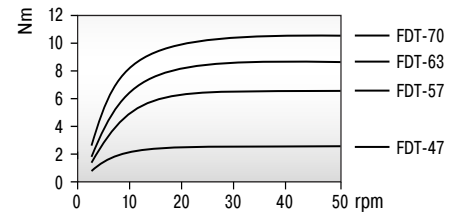

At 20 rpm rotational speed

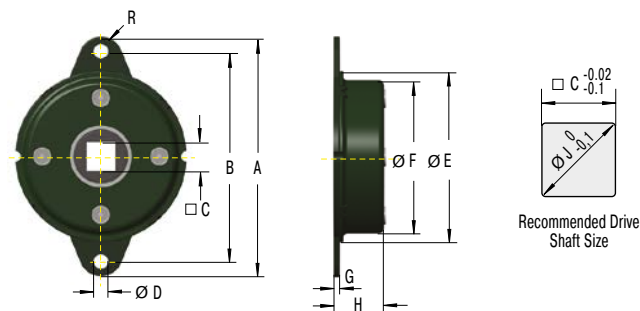
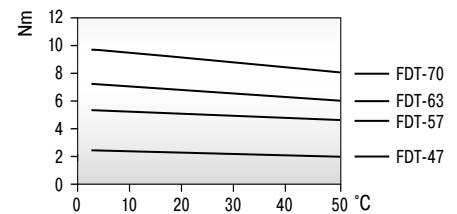

Performance and Dimensions

TYPES	¹ Damping torque Nm	Damping direction	A mm	B mm	C mm	D mm	E mm	F mm	G mm	H mm	R mm	J mm	Weight kg
FDT-47	2.0 +/- 0.3	bidirectional	65	56	8	4.5	47	42.8	1.6	10.3	4.5	10	0.050
FDT-57	4.7 +/- 0.5	bidirectional	79	68	10	5.5	57	52.4	1.6	11.2	5.5	13	0.075
FDT-63	6.7 +/- 0.7	bidirectional	89	76	12.5	6.5	63	58.6	1.6	11.3	6.5	17	0.095
FDT-70	8.7 +/- 0.8	bidirectional	95	82	12.5	6.5	70	65.4	1.6	11.3	6.5	17	0.110

¹ The indicated damping torque refers to a rotational speed of 20 rpm and an ambient temperature of 23 °C.

FDN

The flat disc brake for one direction of rotation

Continuous Rotation

Damping torque 2 Nm to 11 Nm

The damping direction of the flat, strong FDN rotary dampers with steel body can be either right or left rotation. They can brake directly in the pivot point. ACE rotary dampers are maintenance-free and ready-to-install.



Technical Data

Construction size: Ø 47 mm to 70 mm

Rotational speed max.: 50 rpm

Lifetime: 50,000 cycles (1 cycle = 360° left-hand, 360° right-hand). Even after this time, the dampers still produce over approx. 80 % of their original damping moment. The service life may be significantly higher or lower, depending on the application.

Operating temperature range: -10 °C to +50 °C

Material: Outer body: Steel

Mounting: In any position

Information to the shaft:

FDN-47: Ø 6 +0 / -0.03

FDN-57 to FDN-70: Ø 10 +0 / -0.03

Hardness > HRC55, surface smoothness $R_z < 1\mu\text{m}$

Mounting information: Turn the shaft in the opposite direction to the brake direction to avoid damaging the freewheel mount. No axial or radial forces may be induced via the shaft.

Safety instructions: Do not use rotary dampers as supports. Provide an external guide or support.

On request: Special designs available on request.

Characteristics

At 23 °C ambient temperature

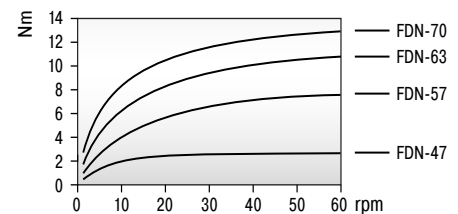

At 20 rpm rotational speed

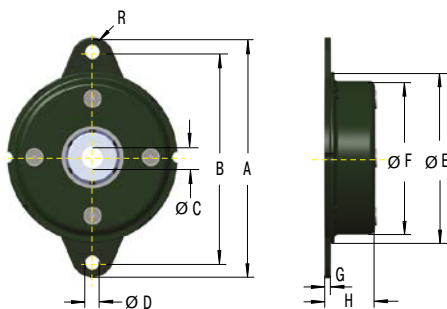
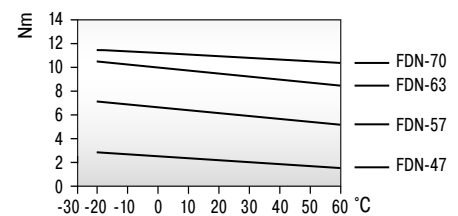

Performance and Dimensions

TYPES	¹ Damping torque Nm	Damping direction	A	B	C	D	E	F	G	H	R	Weight kg
			mm	mm	mm	mm	mm	mm	mm	mm	mm	
FDN-47-R	2.0 +/- 0.3	right	65	56	6	4.5	47	42.8	1.6	10.3	4.5	0.055
FDN-57-R	5.5 +/- 0.3	right	79	68	10	5.5	57	52.4	1.6	14	5.5	0.095
FDN-63-R	8.5 +/- 0.8	right	89	76	10	6.5	63	58.6	1.6	13.9	6.5	0.115
FDN-70-R	11.0 +/- 1.0	right	95	82	10	6.5	70	65.4	1.6	13	6.5	0.135
FDN-47-L	2.0 +/- 0.3	left	65	56	6	4.5	47	42.8	1.6	10.3	4.5	0.055
FDN-57-L	5.5 +/- 0.3	left	79	68	10	5.5	57	52.4	1.6	14	5.5	0.095
FDN-63-L	8.5 +/- 0.8	left	89	76	10	6.5	63	58.6	1.6	13.9	6.5	0.115
FDN-70-L	11.0 +/- 1.0	left	95	82	10	6.5	70	65.4	1.6	13	6.5	0.135

¹ The indicated damping torque refers to a rotational speed of 20 rpm and an ambient temperature of 23 °C.

FYN-P1

Small diameter, large damping torques

Partial Rotation Angle

Damping torque 100 Ncm to 180 Ncm

The damping direction of the rotary damper FYN-P1 can be either right or left rotation. The dampers can be directly FYN mounted in the pivot point. During each reverse movement of the unilateral decelerating versions there is a certain return damping torque that depends on the size. Differentiation of the damping direction through the coloured shaft. ACE rotary dampers are maintenance-free and ready-to-install.



Technical Data

Construction size: Ø 18.5 mm

Lifetime: 50,000 cycles, even after this time, the dampers still produce over approx. 80 % of their original damping moment. The service life may be significantly higher or lower, depending on the application.

Operating temperature range: -5 °C to +50 °C

Material: Outer body, Shaft: Plastic

Mounting: In any position

Rotation angle max.: 115°

Note: Damping direction: Right hand damping = damping action in clockwise direction (when looking onto the output shaft or output shaft sleeve, depending on the damper type). A play of approx. 5° can occur at the beginning of movement.

Mounting information: No axial or radial forces may be induced via the shaft.

Safety instructions: Do not use rotary dampers as supports. Provide an external guide or support.

On request: Special designs available on request.

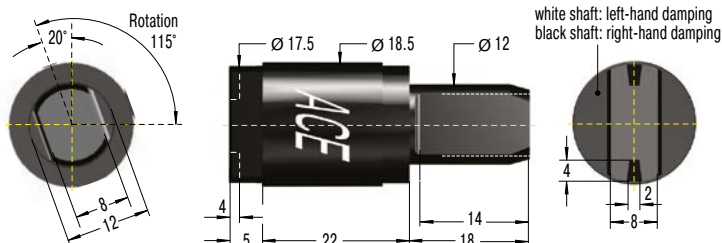

Performance

TYPES	Damping torque Ncm	Return Damping Torque Ncm	Damping direction	Weight kg
FYN-P1-R103	100	30	right	0.011
FYN-P1-R153	150	50	right	0.011
FYN-P1-R183	180	80	right	0.011
FYN-P1-L103	100	30	left	0.011
FYN-P1-L153	150	50	left	0.011
FYN-P1-L183	180	80	left	0.011

FYN-N1

Small diameter, large damping torques

Partial Rotation Angle

Damping torque 100 Ncm to 300 Ncm

The damping direction of the rotary damper FYN-N1 can be either right or left rotation. The dampers can be directly mounted in the pivot point. During each reverse movement of the unilateral decelerating versions there is a certain return damping torque that depends on the size. Differentiation of the damping direction through coloured end cap. ACE rotary dampers are maintenance-free and ready-to-install.



Technical Data

Construction size: Ø 20 mm

Lifetime: 50,000 cycles, even after this time, the dampers still produce over approx. 80 % of their original damping moment. The service life may be significantly higher or lower, depending on the application.

Operating temperature range: -5 °C to +50 °C

Material: Outer body, Shaft: Plastic

Mounting: In any position

Rotation angle max.: 110°

Note: Damping direction: Right hand damping = damping action in clockwise direction (when looking onto the output shaft or output shaft sleeve, depending on the damper type). A play of approx. 5° can occur at the beginning of movement.

Mounting information: No axial or radial forces may be induced via the shaft.

Safety instructions: Do not use rotary dampers as supports. Provide an external guide or support.

On request: Special designs available on request.

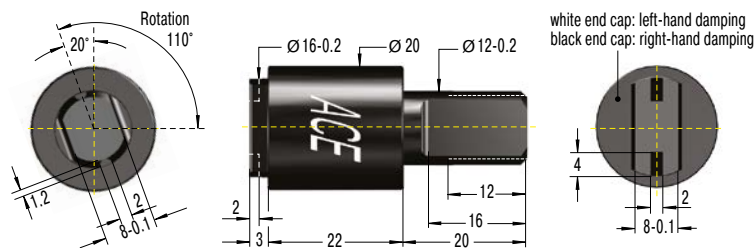

Performance

TYPES	Damping torque Ncm	Return Damping Torque Ncm	Damping direction	Weight kg
FYN-N1-R103	100	20	right	0.012
FYN-N1-R203	200	40	right	0.012
FYN-N1-R253	250	40	right	0.012
FYN-N1-R303	300	80	right	0.012
FYN-N1-L103	100	20	left	0.012
FYN-N1-L203	200	40	left	0.012
FYN-N1-L253	250	40	left	0.012
FYN-N1-L303	300	80	left	0.012

FYN-U1

Small, strong and very robust

Partial Rotation Angle

Damping torque 200 Ncm to 300 Ncm

The damping direction of the rotary damper FYN-U1 can be either right or left rotation. The dampers can be directly mounted in the pivot point. The body is made of especially robust die-cast zinc. During each reverse movement of the unilateral decelerating versions there is a certain return damping torque that depends on the size. ACE rotary dampers are maintenance-free and ready-to-install.



Technical Data

Construction size: Ø 16 mm

Lifetime: 50,000 cycles, even after this time, the dampers still produce over approx. 80 % of their original damping moment. The service life may be significantly higher or lower, depending on the application.

Operating temperature range: -5 °C to +50 °C

Material: Outer body, Shaft: Zinc die-cast

Mounting: In any position

Rotation angle max.: 115°

Note: Damping direction: Right hand damping = damping action in clockwise direction (when looking onto the output shaft or output shaft sleeve, depending on the damper type). A play of approx. 5° can occur at the beginning of movement.

Mounting information: No axial or radial forces may be induced via the shaft.

Safety instructions: Do not use rotary dampers as supports. Provide an external guide or support.

On request: Special designs available on request.

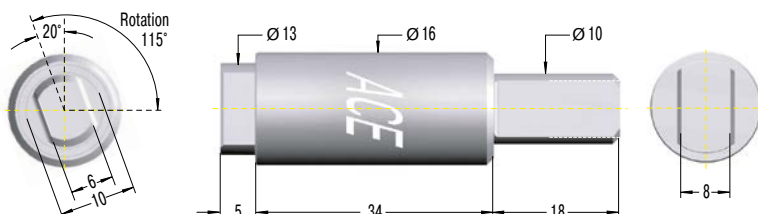

Performance

TYPES	Damping torque Ncm	Return Damping Torque Ncm	Damping direction	Weight kg
FYN-U1-R203	200	40	right	0.040
FYN-U1-R253	250	40	right	0.040
FYN-U1-R303	300	80	right	0.040
FYN-U1-L203	200	40	left	0.040
FYN-U1-L253	250	40	left	0.040
FYN-U1-L303	300	80	left	0.040

FYN-S1

The flat damper for constant component protection

Partial Rotation Angle

Damping torque 5 Nm to 10 Nm

The self-compensating FYN-S1 rotary damper with zinc die-cast body provides a constant sequence of movement for different masses. The damping direction can be either right or left rotation. During each reverse movement of the unilateral decelerating versions there is a certain return damping torque that depends on the size. ACE rotary dampers are maintenance-free and ready-to-install.



Technical Data

Construction size: Ø 60 mm

Lifetime: 50,000 cycles, even after this time, the dampers still produce over approx. 80 % of their original damping moment. The service life may be significantly higher or lower, depending on the application.

Operating temperature range: -5 °C to +50 °C

Material: Outer body: Zinc die-cast; Output shaft sleeve: Plastic

Mounting: In any position

Rotation angle max.: 130°

Note: Damping direction: Right hand damping = damping action in clockwise direction (when looking onto the output shaft or output shaft sleeve, depending on the damper type). A play of approx. 5° can occur at the beginning of movement.

Mounting information: No axial or radial forces may be induced via the shaft.

Safety instructions: Do not use rotary dampers as supports. Provide an external guide or support.

On request: Special designs available on request.

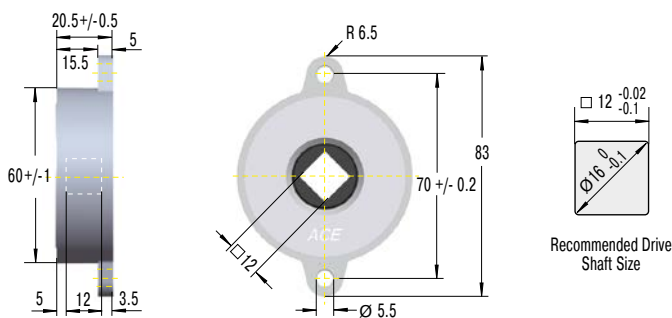

Recommended Drive Shaft Size

Performance

TYPES	Damping torque Nm	Return Damping Torque Nm	Damping direction	Weight kg
FYN-S1-R104	5 - 10	1.5	right	0.220
FYN-S1-L104	5 - 10	1.5	left	0.220

FYT-H1 and FYN-H1

Specifically adjustable, strong braking force

**Partial Rotation Angle, Adjustable
Damping torque 2 Nm to 10 Nm**

The damping direction of the adjustable FYT-H1 and FYN-H1 can be right, left or two-sided rotation. During each reverse movement of the unilateral decelerating versions there is a certain return damping torque that depends on the size. The brakes have a particularly robust zinc die-cast body and shafts made of steel. ACE rotary dampers are maintenance-free and ready-to-install.



Technical Data

Construction size: Ø 45 mm

Lifetime: 50,000 cycles, even after this time, the dampers still produce over approx. 80 % of their original damping moment. The service life may be significantly higher or lower, depending on the application.

Operating temperature range: -5 °C to +50 °C

Material: Outer body: Zinc die-cast; Shaft: Steel

Mounting: In any position

Rotation angle max.: 105°

Maximum side load: 50 N

Note: Damping direction: Right hand damping = damping action in clockwise direction (when looking onto the output shaft or output shaft sleeve, depending on the damper type). A play of approx. 5° can occur at the beginning of movement.

Safety instructions: Do not use rotary dampers as supports. Provide an external guide or support.

On request: Special designs available on request.

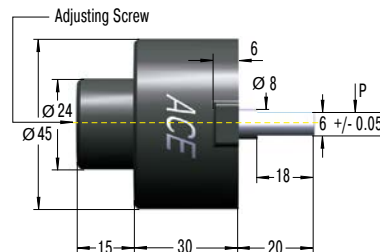
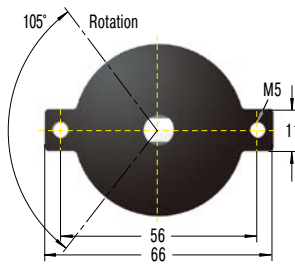

Performance				
TYPES	Damping torque Nm	Return Damping Torque Nm	Damping direction	Weight kg
FYT-H1	2 - 10	0.5	bidirectional	0.235
FYN-H1-R	2 - 10	0.5	right	0.235
FYN-H1-L	2 - 10	0.5	left	0.235

Issue 07.2017 – Specifications subject to change

FYT-LA3 and FYN-LA3

Adjustable high performance

**Partial Rotation Angle, Adjustable
Damping torque 4 Nm to 40 Nm**

The damping direction of this adjustable high-performance rotary damper can be right, left or two-sided rotation. During each reverse movement of the unilateral decelerating versions there is a certain return damping torque that depends on the size. The brakes have a particularly robust zinc die-cast body and shafts made of steel. ACE rotary dampers are maintenance-free and ready-to-install.



Technical Data

Construction size: Ø 80 mm

Lifetime: 50,000 cycles, even after this time, the dampers still produce over approx. 80 % of their original damping moment. The service life may be significantly higher or lower, depending on the application.

Operating temperature range: -5 °C to +50 °C

Material: Outer body: Zinc die-cast; Shaft: Steel

Mounting: In any position

Rotation angle max.: 210°

Maximum side load: 200 N

Note: Damping direction: Right hand damping = damping action in clockwise direction (when looking onto the output shaft or output shaft sleeve, depending on the damper type). A play of approx. 5° can occur at the beginning of movement.

Safety instructions: Do not use rotary dampers as supports. Provide an external guide or support.

On request: Special designs available on request.

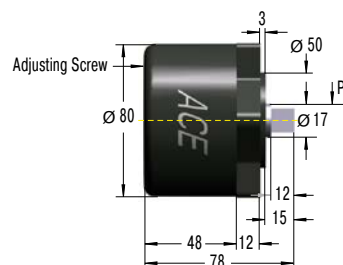
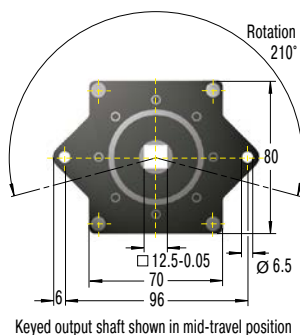

Performance

TYPES	Damping torque Nm	Return Damping Torque Nm	Damping direction	Weight kg
FYT-LA3	4 - 40	4	bidirectional	1.720
FYN-LA3-R	4 - 40	4	right	1.725
FYN-LA3-L	4 - 40	4	left	1.725

Calculation Example

Damping of a Lid

To select an appropriate rotary damper for the adjacent calculation example, the length and the weight or the centre of gravity of the flap have to be known. After determining the value of the max. torque at an unfavourable angle of the flap, select the appropriate damper.

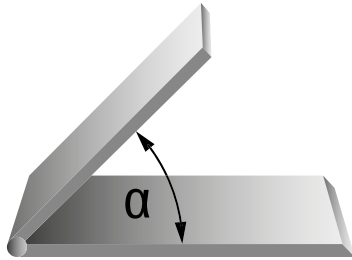

Calculation Steps

1. Calculate max. torque damper will be exposed to (with example shown on the left max. torque is at $\alpha = 0^\circ$).
2. Decide upon rotation speed desired.
3. Choose a rotary damper that can handle the torque calculated above.
4. With the aid of the damper performance curves, check if the r.p.m. given at your torque corresponds to the desired closing speed of the lid.
5. If the r.p.m. is too high – choose a damper with a higher torque rating.
If the r.p.m. is too low – choose a damper with a lower torque rating.

Closing Torque
 $M = L / 2 \cdot m \cdot g \cdot \cos \alpha$
 (L / 2 = centre of gravity)

m Mass of a lid [kg] (1 kg = 9.81 N)
L Length of lid from pivot [cm]
n Rotation speed [r.p.m.]

Special Accessories

Toothed Racks for Rotary Dampers with Gear

Rotary dampers with gears are available in four standard modules which can be optionally supplied with plastic toothed racks as accessories.

M0.5, M0.6, M0.8, M1.0
Toothed Rack

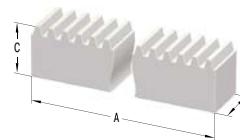

M0.8P
Toothed Rack

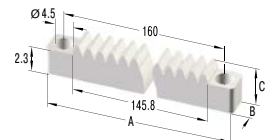

Delivery Notes

Delivery form: Toothed plastic racks with modules 0.5 to 1.0 available ex stock

On request: Toothed metal racks

Dimensions

TYPES	A mm	B mm	C mm	Model
M0.5	250	4	4.5	rigid, milled
M0.6	250	4	6	rigid, milled
M0.8	250	6	8	rigid, milled
M0.8P	170	8	4.1	flexible, milled
M1.0	250	9	9	rigid, milled
M1.0	500	10	10	rigid, milled

Mounting Information

The rotary axis, square receptacles or free-wheel receptacles are not designed for lateral loads. An external guide or bearing support is fundamentally recommended.

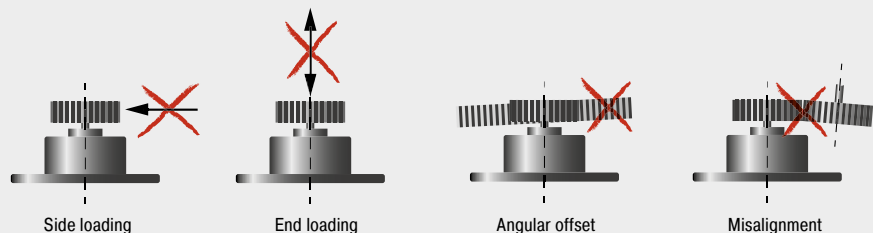

Application Examples

FDT

Finger protection when cutting bread

To exclude the possibility of injury when using bread slicing machines on self-service counters, the automatic bread slicing process does not start until the flap of the modern machine is closed. To simplify the operation and to thereby increase acceptance of the self-slicing principle among users, two-way rotary dampers of the type FDT-57 ensure smooth opening and closing of the door. Even when rotary dampers must act only in one direction, ACE has appropriate variants readily available.



Protective flaps secured with rotary dampers: the simple operation of bread slicing machines can then be easily managed by hand
Daub Bakery Machinery BV, 5050 AB Goirle, Netherlands

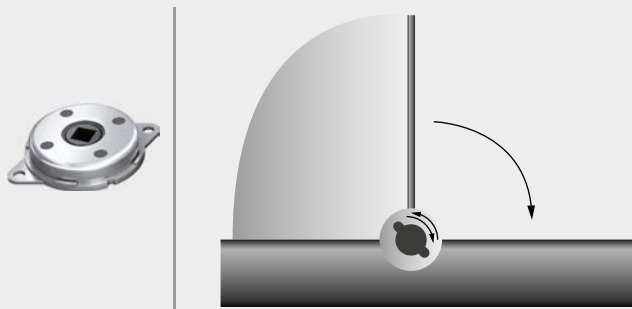

FDN-R

Invisible protection for cooker hoods

For ergonomic handling, modern cooker hoods can be driven by a motor into an up position and then down again. When driven downwards, an AC load can result in a total loss through current being fed back into the voltage source. One of the tasks of the ACE rotary dampers type FDN-63-R is to prevent this. The modern machine elements are also built to provide protection against motor failure. Sliding the hood down too quickly could lead to further costly damage to the hood and the ceiling console and even cause personal injury.



Rotary dampers in high-end cooker hoods safeguard the protection of drive units and protect chefs, even during power failures
berbel Ablufttechnik GmbH, 48432 Rheine, Germany



Vibration Control

Vibration-Isolating Pads
Rubber-Metal Isolators
Low Frequency Pneumatic Levelling Mounts



Isolate Unwanted Vibrations Effectively

Unique variety

This product group from ACE includes innovative solutions to provide customers with the best assistance in insulation technology and vibration isolation. These machine elements are also distinguished by their light design and exemplary variety.

The product range extends from extremely low frequency isolating pneumatic levelling mounts through to ready-to-install rubber-metal isolators and insulation plates. With this portfolio, ACE is capable of offering you customised vibration isolation and all almost any applications.

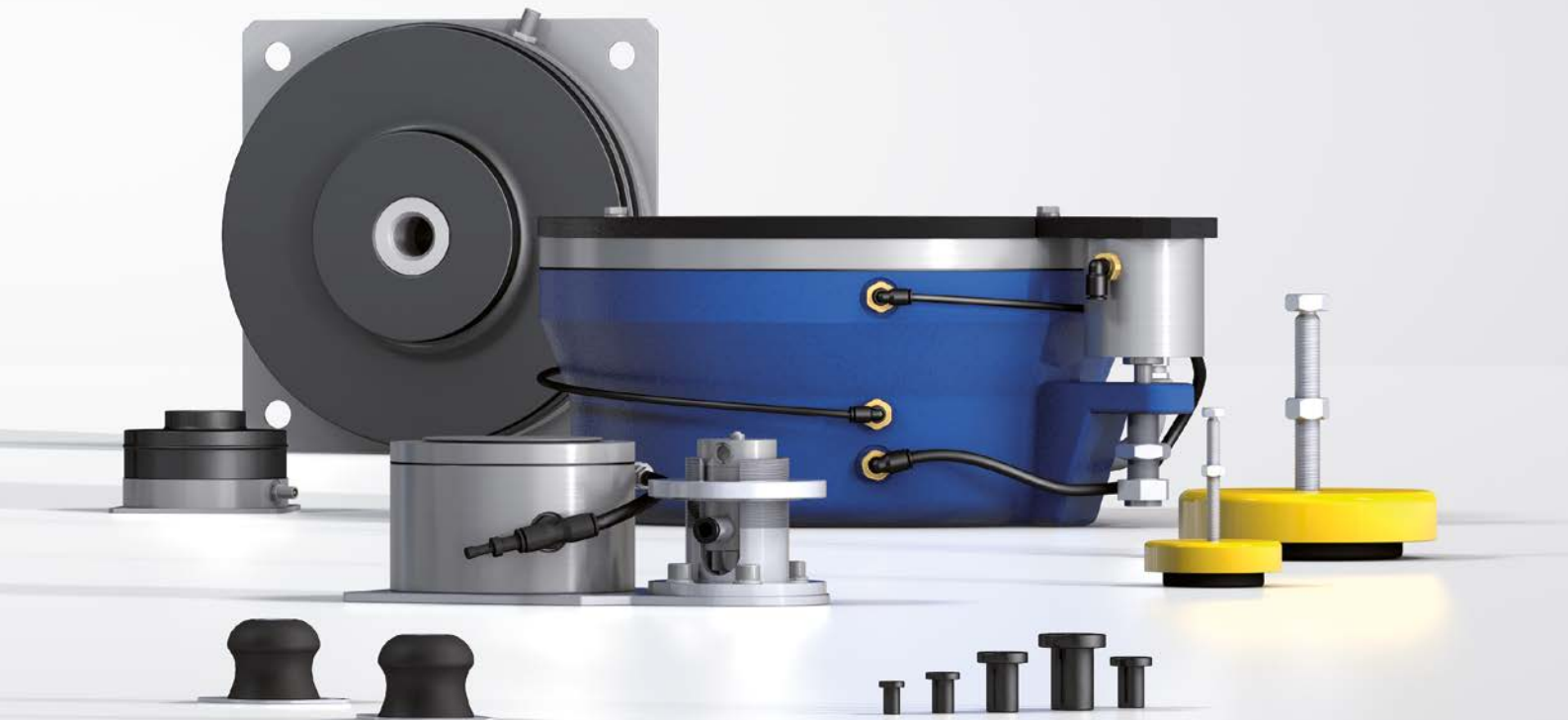

Vibration Isolation

Noise reduction and vibration isolation are becoming more and more important in our daily lives. This applies in particular to the workplace and the environments around production companies.

Preventing noise emissions or harmful vibrations is therefore not only a necessity required by noise protection and occupational health and safety legislation; their sources must also be localised by means of targeted analyses in order to develop suitable improvement measures for achieving, for example, increased production quality. A second by-product of vibrations are their effects on the surrounding production environment and any measuring and testing facilities that may be in use.

Advantages and function

- improved working conditions for people and the environment
- more accurate production tolerances and thereby increased product quality
- competitive and cost advantages thanks to lower reject rate in production
- increased production speed thanks to increased maximum machine dynamics
- longer tool and machine life thanks to lower stress
- faster and more accurate measuring results

For detailed
information see
special catalogue
"ACEolator"



Rubber-Metal Isolators

Ready-to-install isolators for quick selection

Rubber-metal isolators and machine feet are supplied ready-to-install and are used in a large variety of vibration isolation applications. Common applications are engines, compressors, transfer systems, machines, fans and blowers.



LEV

Levelling Mounts (height-adjustable machine feet)

Secure, adjustable stabilisation for all types of machines, transfer systems, assembly stations, etc.



CM

Cup Mounts (cup elements)

For isolating machinery and equipment. Fail-safe isolators for all axes in any installation position. Application examples: compressors, off-road vehicles, engines, fans, etc.



COM

Compression Mounts (pre-tensioned high-performance bearing surface)

Vertically acting isolators for machinery and equipment. Applications include: blowers, compressors, motors, generators, presses, etc.



AAM

All Attitude Mounts (vibration-isolating fasteners)

Maintenance free isolators for decoupling parts and components in electronics, aerospace, the military, medicine, transfer systems, etc.



SFM

Stable Flex Mounts (stable machine feet)

Extremely rugged and maintenance-free isolators, e.g. for marine applications, for diesel generators, in power generation or in off-road vehicles.



BM

Bubble Mounts (low-frequency vibration isolators)

For protecting small devices and electronic components, e.g. in medical technology, aerospace, electronic systems or computers.



UMO

Universal Mounts (universal connection isolators)

Maintenance-free connection isolators which can be implemented both radially and axially. Application examples: conveying systems, machinery and equipment, off-road, oil and gas industry, control systems, etc.



FL

Flex Locs (quick fastening elements)

Simple, efficient components with versatile applications as isolating fasteners for decoupling structure-borne sound in enclosures, housings, equipment and machinery. For application in mechanical engineering, in buildings, vehicles, or navigation.

Vibration-Isolating Pads

Customised insulation technology through cutting and combining

A wide range of applications such as e.g. machine foundations, supports, decoupling elements, pipelines and subsequently protected machines require tailor-made solutions. Here with its product range of vibration insulating pads ACE offers comprehensive possibilities for insulation. The products are manufactured and supplied either as standard pads or as drawing parts according to customer request.



SLAB

Universal Damping Pads

For application on foundations for plants and machines, compressors, in pump stations, generators, for insulations, measuring tables, buildings, etc.



CEL

Low-Frequency Damping Pads

For use in foundations, buildings, transport routes, bridges, stairs, test benches, pump stations, generators, compressors, machines, etc.



PAD

Rugged Fibre and Elastomer Pads

For isolating and protecting foundations, e.g. of presses, plants, machines, as well as for use in pump stations, crane runways, bridges and heavy-duty applications

Application overview

Type	Machines	Transfer systems	Construction Transport	Blower Fan	Foundations	Control units Electrical systems	Off-road vehicles
Rubber-Metal Isolators							
LEV	■	■		■			
CM	■		■	■			■
COM	■	■		■		■	
AAM		■	■			■	■
SFM			■				■
BM				■		■	
UMO	■	■	■			■	■
FL	■		■			■	
Vibration-Isolating Pads							
SLAB	■	■	■	■	■		
CEL	■	■	■	■	■		
PAD	■		■		■		■
Air Spring Elements							
PLM	■						
PAL					■		

Issue 07.2017 – Specifications subject to change

Low Frequency Pneumatic Levelling Mounts

Highly efficient insulation – it can hardly get any deeper

Everywhere where perfect isolation of measuring tables, test equipment and high-performance machines are important the low frequency pneumatic levelling mounts PLM and PAL are a good choice. On request a detailed system analysis will be carried out at the customer and the perfect solution will be developed.



PLM

Pneumatic Air Spring Elements

For an efficient isolation of measuring equipment, high-speed presses and machines.



PAL-3 to PAL-9

Small Size Air Spring Elements

The perfect levelling and isolation system for smaller constructions that require precision and flexibility. Available in the system with many accessories.



PAL-18 to PAL-1000

Big Air Spring Elements with Automatic Level Controls

Isolation against disruptive vibrations and level-adjustment for test and measuring equipment. Isolating at extremely low-frequencies, these components are used in the automotive industry and in aerospace engineering.

More information about Vibration Control can be found in our special catalog and on our Website [www.ace-ace.com / Downloads](http://www.ace-ace.com/Downloads)

Issue 07.2017 – Specifications subject to change

Engines Generators	Compressors	Oil and gas industry	Aerospace engineering	Presses	Medicine	Measuring tables	Test benches	Type
Rubber-Metal Isolators								
				■				LEV
■	■	■	■					CM
■	■			■				COM
■			■		■			AAM
■	■							SFM
					■			BM
■	■	■	■					UMO
■	■							FL
Vibration-Isolating Pads								
		■		■	■	■		SLAB
		■		■	■	■	■	CEL
		■		■				PAD
Air Spring Elements								
				■	■	■	■	PLM
			■			■	■	PAL

Safety Products

**Safety Shock Absorbers, Safety Dampers
Clamping Elements**



Highest Protection under any Circumstances

For any budget and all requirements

**Safely slowing down damaging forces from moving loads or
Emergency braking are united in this product group from ACE.
Although the safety shock absorbers, profile dampers and
clamping elements differ so much in design, every single ACE
component provides the best protection for your machine.**

They demonstrate their main advantages in emergency stop situations
and, based on the protection they provide, are very cost-effective.
Furthermore, they can all be easily integrated in the existing construction
designs and largely work independent of energy supplies.



Safety Shock Absorbers

Perfect protection for the worst case scenario

As a cheaper alternative to the standard shock absorber, Safety shock absorbers are the tried and tested low cost method of preventing those occasional emergency stops. Designed for occasional use, they primarily serve as reliable, effective protection in emergency stopping for construction designs.

The maintenance-free and ready-to-install machine elements are characterised in every respect by the well-known high ACE quality and maximum energy absorption of up to 480,000 Nm/Cycle. This means, in the product family SCS33 up to SCS64 a service life of up to 1,000 full load emergency cycles is achieved. Safety shock absorbers from ACE are available in a large choice with strokes of 23 mm to 1,200 mm, and the arrangement of orifice pattern can be calculated and produced specifically to the customer's requirements and depending on the application.



Safety Shock Absorbers



SCS33 to SCS64

Page 250

Self-Compensating or Optimized Characteristic

Industry design with high energy absorption

Finishing and processing centres, Conveyor systems, Portal systems, Test stations



SDH38 to SDH63

Page 254

High Rack Damper, Optimized Characteristic

Low reaction forces with long strokes

Shelf storage systems, Test stations, Heavy load applications, Conveyor systems



SDP63 to SDP160

Page 258

Crane Installations, Optimized Characteristic

High return forces with gas pressure accumulator

Shelf storage systems, Heavy load applications

Top machine protection

Latest damping technology

Attractive cost-benefit ratio

Maximum traverses

Wide application spectrum

Robust design



SCS33 to SCS64

Industry design with high energy absorption

Self-Compensating or Optimized Characteristic
Energy capacity 310 Nm/Cycle to 18,000 Nm/Cycle
Stroke 23.1 mm to 150 mm

Effective emergency stop: The ACE safety shock absorbers from the SCS33 to SCS64 product family are based on the innovative technology of the successful industrial shock absorbers from the MAGNUM-Series. They are also maintenance-free and ready-to-install.

Due to the optimised characteristic curve for the respective application, the energy absorption of these hydraulic machine elements can be increased to more than twice the level of the MAGNUM model of ACE industrial shock absorber per stroke. Users benefit from a service life of up to 1,000 full load emergency cycles with a very good price-performance ratio. Their compact design in sizes M33x1.5 to M64x2 makes them easy to integrate into current applications.

These slimline, high-performance safety shock absorbers are only designed for emergency stop situations. They can be used for a number of tasks in gantries and conveyor systems, processing centres or assembly machines.

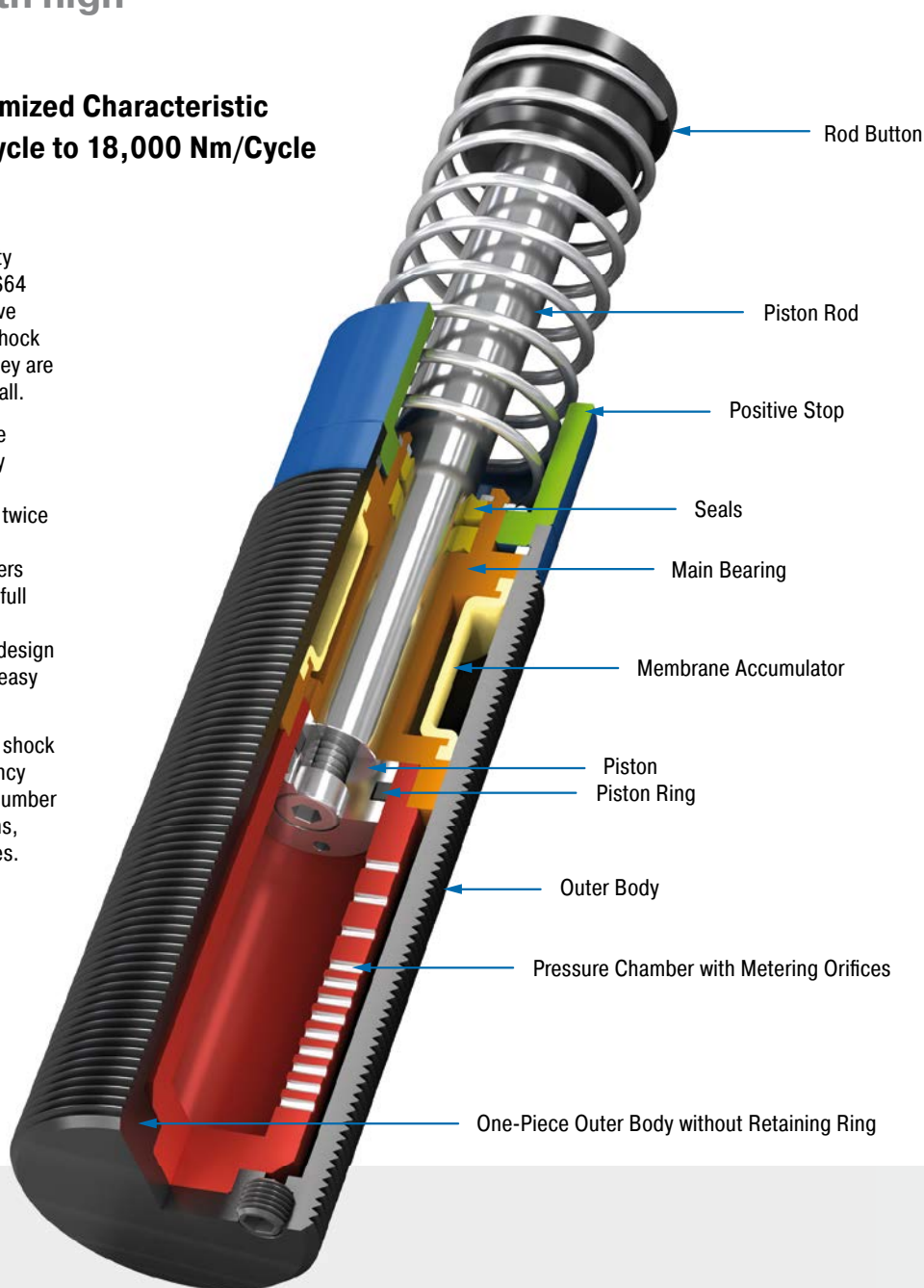

Technical Data

Energy capacity: 310 Nm/Cycle to 18,000 Nm/Cycle

Impact velocity range: 0.02 m/s to 5 m/s. Other speeds on request.

Operating temperature range: -12 °C to +66 °C. Other temperatures on request.

Mounting: In any position

Positive stop: Integrated

Material: Outer body: Nitride hardened steel; Piston rod: Hard chrome plated steel; Rod end button: Hardened steel and corrosion-resistant coating; Return spring: Zinc plated or plastic-coated steel; Accessories: Steel corrosion-resistant coating

Damping medium: Automatic Transmission Fluid (ATF)

Application field: Finishing and processing centres, Conveyor systems, Portal systems, Test stations, Machines and plants, Swivel units, Cranes

Note: The shock absorber can be pushed through its stroke. In creep speed conditions the shock absorber provides minimal resistance and there is no braking effect.

On request: Special oils, special flanges etc.

SCS33EU

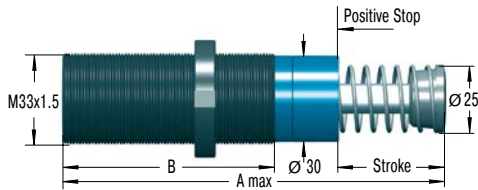

The calculation and selection of the most suitable damper should be carried out or be approved by ACE.

Accessories

NM33

Locking Ring

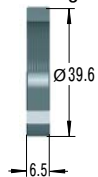

QF33

Square Flange

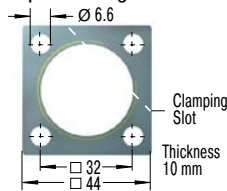

Torque max.: 11 Nm
Clamping torque: > 90 Nm
Install with 4 machine screws

S33

Side Foot Mounting Kit

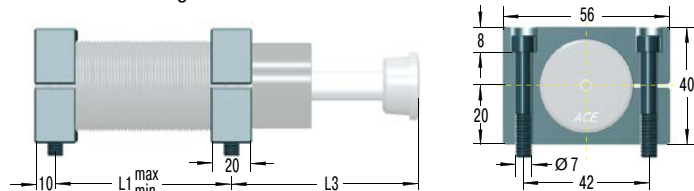

S33 = 2 flanges + 4 screws M6x40, DIN 912

Torque max.: 11 Nm

Clamping torque: 90 Nm

Because of the thread pitch the fixing holes for the second foot mount should only be drilled and tapped after the first foot mount has been fixed in position.

Complete details required when ordering

Moving load: m (kg)
Impact velocity range: v (m/s) max.
Creep speed: vs (m/s)
Motor power: P (kW)
Stall torque factor: ST (normal, 2.5)
(Alternatively: Propelling force F (N))
Number of absorbers in parallel: n

or technical data according to formulae and calculations on page 265.

Ordering Example

Safety Shock Absorber **SCS33-50EU-1xxxx**
Thread Size M33
Max. Stroke without Positive Stop 50 mm
EU Compliant
Identification No. assigned by ACE

Please indicate identification no. in case of replacement order

Performance and Dimensions

TYPES	Max. Energy Capacity		Return Force min.	Return Force max.	Stroke mm	A max. mm	B mm	L1 min. mm	L1 max. mm	L3 mm	Side Load Angle max. °	Weight kg
	W ₃ Self-compensating Nm/cycle	W ₃ Optimised Nm/cycle										
SCS33-25EU	310	500	45	90	23.2	138	83	25	60	68	3	0.51
SCS33-50EU	620	950	45	135	48.6	189	108	32	86	93	2	0.63

¹ The values are reduced by 20 % at max. side load angle.

SCS45EU

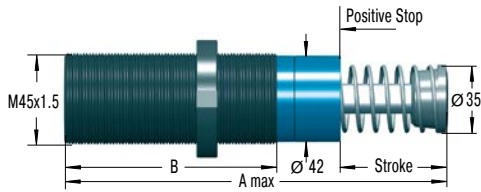

The calculation and selection of the most suitable damper should be carried out or be approved by ACE.

Accessories

NM45

Locking Ring

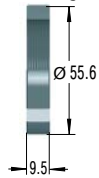

QF45

Square Flange

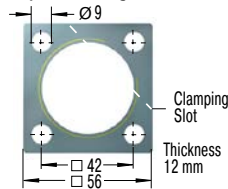

Torque max.: 27 Nm
Clamping torque: > 200 Nm
Install with 4 machine screws

S45

Side Foot Mounting Kit

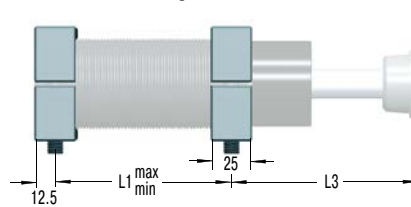

S45 = 2 flanges + 4 screws M8x50, DIN 912
Torque max.: 27 Nm
Clamping torque: 350 Nm

Because of the thread pitch the fixing holes for the second foot mount should only be drilled and tapped after the first foot mount has been fixed in position.

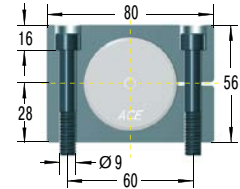

Complete details required when ordering

- Moving load: m (kg)
- Impact velocity range: v (m/s) max.
- Creep speed: vs (m/s)
- Motor power: P (kW)
- Stall torque factor: ST (normal, 2.5)
- (Alternatively: Propelling force F (N))
- Number of absorbers in parallel: n

or technical data according to formulae and calculations on page 265.

Ordering Example

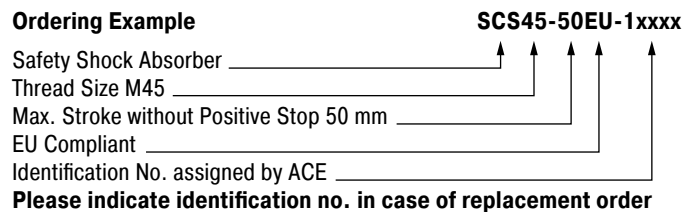

Please indicate identification no. in case of replacement order

Performance and Dimensions

TYPES	Max. Energy Capacity		Return Force min. N	Return Force max. N	Stroke mm	A max. mm	B mm	L1 min. mm	L1 max. mm	L3 mm	Side Load Angle max. °	Weight kg
	W ₃ Self-compensating Nm/cycle	W ₃ Optimised Nm/cycle										
SCS45-25EU	680	1,200	70	100	23.1	145	95	32	66	66	3	1.13
SCS45-50EU	1,360	2,350	70	145	48.5	195	120	40	92	91	2	1.36
SCS45-75EU	2,040	3,500	50	180	73.9	246	145	50	118	116	1	1.59

¹ The values are reduced by 20 % at max. side load angle.

SCS64EU

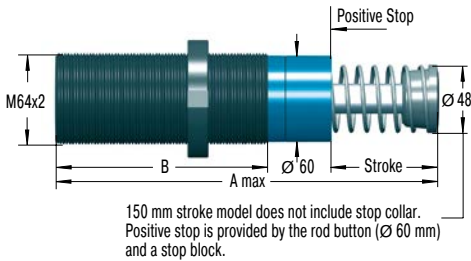

The calculation and selection of the most suitable damper should be carried out or be approved by ACE.

Accessories

NM64

Locking Ring

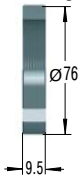

QF64

Square Flange

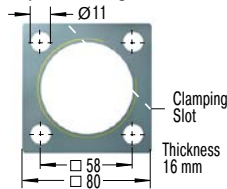

Torque max.: 50 Nm
Clamping torque: > 210 Nm
Install with 4 machine screws

S64

Side Foot Mounting Kit

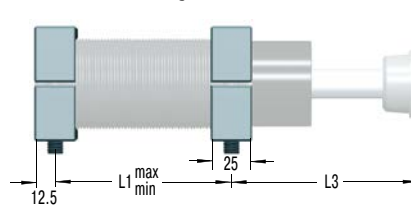

S64 = 2 flanges + 4 screws M10x80, DIN 912

Torque max.: 50 Nm

Clamping torque: 350 Nm

Because of the thread pitch the fixing holes for the second foot mount should only be drilled and tapped after the first foot mount has been fixed in position.

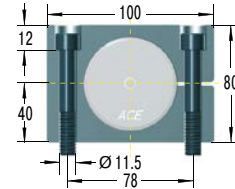

Complete details required when ordering

Moving load: m (kg)
Impact velocity range: v (m/s) max.
Creep speed: vs (m/s)
Motor power: P (kW)
Stall torque factor: ST (normal, 2.5)
(Alternatively: Propelling force F (N))
Number of absorbers in parallel: n

or technical data according to formulae and calculations on page 265.

Ordering Example

SCS64-50EU-1xxxx
Safety Shock Absorber _____
Thread Size M64 _____
Max. Stroke without Positive Stop 50 mm _____
EU Compliant _____
Identification No. assigned by ACE _____

Please indicate identification no. in case of replacement order

Performance and Dimensions

TYPES	Max. Energy Capacity		Return Force min. N	Return Force max. N	Stroke mm	A max. mm	B mm	L1 min. mm	L1 max. mm	L3 mm	Side Load Angle max. °	Weight kg
	W ₃ Self-compensating Nm/cycle	W ₃ Optimised Nm/cycle										
SCS64-50EU	3,400	6,000	90	155	48.6	225	140	50	112	100	3	2.90
SCS64-100EU	6,800	12,000	105	270	99.4	326	191	64	162	152	2	3.70
SCS64-150EU	10,200	18,000	75	365	150.0	450	241	80	212	226	1	5.10

¹ The values are reduced by 20 % at max. side load angle.

SDH38 to SDH63

Low reaction forces with long strokes

High Rack Damper, Optimized Characteristic
Energy capacity 3,600 Nm/Cycle to 229,100 Nm/Cycle
Stroke 100 mm to 800 mm

Intelligent protective measure: The safety shock absorbers from the SDH38 to SDH63 series are also designed for emergency-stop applications. Strokes of up to 1,200 mm are possible with these maintenance-free and ready-to-install dampers. Low support forces result due to the large strokes.

The characteristic curve or damping characteristics of all safety shock absorbers from ACE is individually adjusted to the respective application, specific to the customer. The metering orifices for the respective application are specially calculated and produced. These tailor-made machine elements are the ideal protection because they are less expensive than industrial shock absorbers and are effective with up to 1,000 maximum full load emergency cycles possible.

Anyone who wants to reliably protect the end positions of rack operating equipment, conveyor and crane systems, heavy duty applications and test benches chooses these safety shock absorbers from ACE.

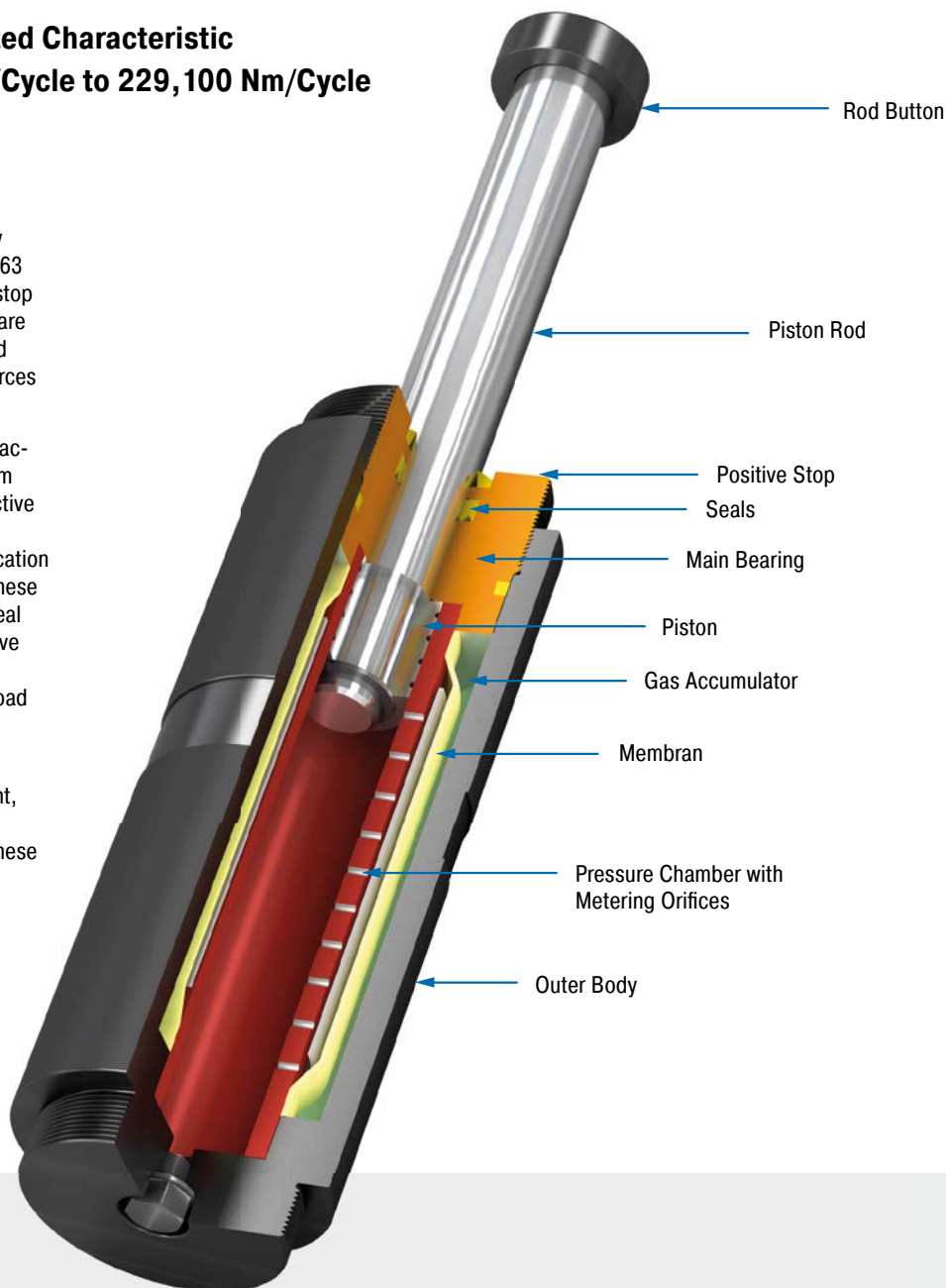

Technical Data

Energy capacity: 3,600 Nm/Cycle to 229,100 Nm/Cycle

Impact velocity range: 0.5 m/s to 4.6 m/s. Other speeds on request.

Reacting force: At max. capacity rating = 51 kN to 210 kN

Operating temperature range: -20 °C to +60 °C. Other temperatures on request.

Mounting: In any position

Positive stop: Integrated

Material: Outer body: Painted steel; Piston rod: Hard chrome plated steel; Rod end button: Steel

Damping medium: HLP 46

Filling pressure: Approx. 5 bar. Rod return by integrated nitrogen accumulator.

Application field: Shelf storage systems, Test stations, Heavy load applications, Conveyor systems, Portal systems

Note: For creep speed applications, please consult ACE.

On request: Special oils, special flanges, additional corrosion protection etc. Integrated rod sensor for indicating the complete extension of the piston rod. Type normally closed or normally open, option PNP or NPN switch.

SDH38EU-F Front Flange

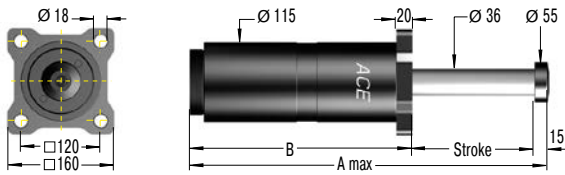

SDH38EU-R Rear Flange

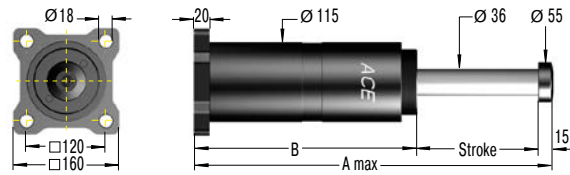

SDH38EU-S Foot Mount

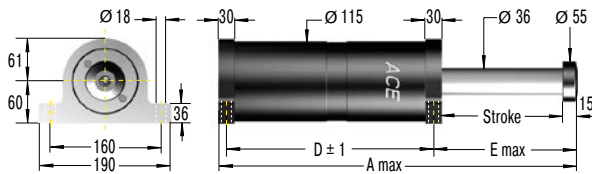

Technical Data

Impact velocity range: 0.9 m/s to 4.6 m/s

Complete details required when ordering

- Moving load: m (kg)
- Impact velocity range: v (m/s) max.
- Creep speed: vs (m/s)
- Motor power: P (kW)
- Stall torque factor: ST (normal, 2.5)
- (Alternatively: Propelling force F (N))
- Number of absorbers in parallel: n

or technical data according to formulae and calculations on page 265.

The calculation and selection of the most suitable damper should be carried out or be approved by ACE.

Ordering Example

SDH38-400EU-F-XXXX

- Safety Shock Absorber _____
- Bore Size Ø 38 mm _____
- Stroke 400 mm _____
- EU Compliant _____
- Mounting Style: Front Flange _____
- Identification No. assigned by ACE _____

Please indicate identification no. in case of replacement order

Performance and Dimensions

TYPES	¹ Energy capacity Nm/cycle	¹ Reacting Force N	Return Force		Stroke mm	A max. mm	B mm	D mm	E max. mm	Mounting Style	
			min. N	max. N						F and R Weight kg	S Weight kg
SDH38-50EU	3,600	80,000	600	700	50	270	204	165	84	14.0	13.7
SDH38-100EU	7,300	80,000	600	700	100	370	254	215	134	15.5	15.7
SDH38-150EU	10,900	80,000	600	700	150	470	304	265	184	17.0	17.2
SDH38-200EU	14,500	80,000	600	700	200	585	369	330	234	20.0	19.7
SDH38-250EU	18,200	80,000	600	700	250	685	419	380	284	22.0	21.7
SDH38-300EU	21,800	80,000	600	700	300	800	484	445	334	24.0	23.7
SDH38-350EU	25,500	80,000	600	700	350	900	534	495	384	26.0	25.7
SDH38-400EU	29,100	80,000	600	700	400	1,015	599	560	434	28.0	28.2
SDH38-500EU	36,400	80,000	600	700	500	1,230	714	675	534	32.0	32.2
SDH38-600EU	43,600	80,000	600	700	600	1,445	829	790	634	36.0	36.2
SDH38-700EU	50,900	80,000	600	700	700	1,660	944	905	734	40.0	40.2
SDH38-800EU	58,200	80,000	600	700	800	1,875	1,059	1,020	834	44.0	44.2

¹ The values apply to mounting style Front Flange and Foot Mounting. For mounting style Rear Flange, please consult ACE.
In case of an existing side load angle, please consult ACE.

SDH50EU-F Front Flange

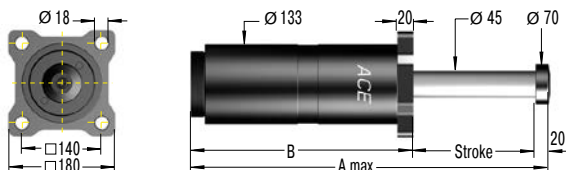

SDH50EU-R Rear Flange

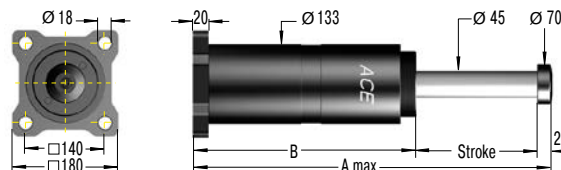

SDH50EU-S Foot Mount

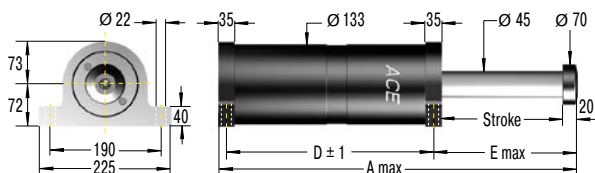

Technical Data

Impact velocity range: 0.6 m/s to 4.6 m/s

Complete details required when ordering

- Moving load: m (kg)
- Impact velocity range: v (m/s) max.
- Creep speed: vs (m/s)
- Motor power: P (kW)
- Stall torque factor: ST (normal, 2.5)
- (Alternatively: Propelling force F (N))
- Number of absorbers in parallel: n

or technical data according to formulae and calculations on page 265.

The calculation and selection of the most suitable damper should be carried out or be approved by ACE.

Ordering Example

SDH50-400EU-F-XXXXX
 Safety Shock Absorber _____
 Bore Size Ø 50 mm _____
 Stroke 400 mm _____
 EU Compliant _____
 Mounting Style: Front Flange _____
 Identification No. assigned by ACE _____

Please indicate identification no. in case of replacement order

Performance and Dimensions

TYPES	¹ Energy capacity Nm/cycle	¹ Reacting Force N	Return Force		Stroke mm	A max. mm	B mm	D mm	E max. mm	Mounting Style	
			min. N	max. N						F and R Weight kg	S Weight kg
SDH50-100EU	14,500	160,000	1,000	1,200	100	416	297	258	139	23.5	25.0
SDH50-150EU	21,800	160,000	1,000	1,200	150	516	347	308	189	26.0	27.5
SDH50-200EU	29,100	160,000	1,000	1,200	200	616	397	358	239	28.5	30.0
SDH50-250EU	36,400	160,000	1,000	1,200	250	731	462	423	289	32.0	33.5
SDH50-300EU	43,600	160,000	1,000	1,200	300	831	512	473	339	34.5	36.0
SDH50-350EU	50,900	160,000	1,000	1,200	350	931	562	523	389	37.0	38.5
SDH50-400EU	58,200	160,000	1,000	1,200	400	1,046	627	588	439	40.0	41.5
SDH50-500EU	72,700	160,000	1,000	1,200	500	1,261	742	703	539	46.0	47.5
SDH50-600EU	87,300	160,000	1,000	1,200	600	1,476	857	818	639	52.0	53.5
SDH50-700EU	101,800	160,000	1,000	1,200	700	1,691	972	933	739	58.0	59.5
SDH50-800EU	116,400	160,000	1,000	1,200	800	1,906	1,087	1,048	839	64.0	65.5
SDH50-1000EU	145,500	160,000	1,000	1,200	1,000	2,336	1,317	1,278	1,039	75.0	76.5

¹ The values apply to mounting style Front Flange and Foot Mounting. For mounting style Rear Flange, please consult ACE.
In case of an existing side load angle, please consult ACE.

SDH63EU-F Front Flange

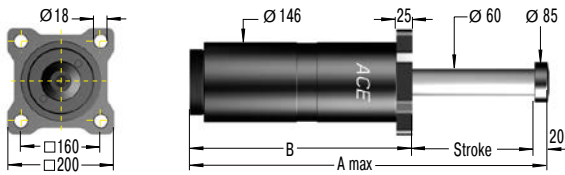

SDH63EU-R Rear Flange

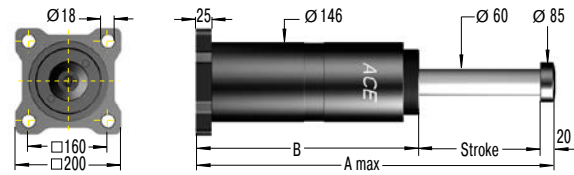

SDH63EU-S Foot Mount

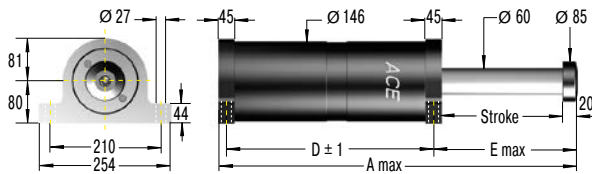

Technical Data

Impact velocity range: 0.5 m/s to 4.6 m/s

Complete details required when ordering

- Moving load: m (kg)
- Impact velocity range: v (m/s) max.
- Creep speed: vs (m/s)
- Motor power: P (kW)
- Stall torque factor: ST (normal, 2.5)
- (Alternatively: Propelling force F (N))
- Number of absorbers in parallel: n

or technical data according to formulae and calculations on page 265.

The calculation and selection of the most suitable damper should be carried out or be approved by ACE.

Ordering Example

SDH63-400EU-F-XXXXX
 Safety Shock Absorber _____
 Bore Size Ø 63 mm _____
 Stroke 400 mm _____
 EU Compliant _____
 Mounting Style: Front Flange _____
 Identification No. assigned by ACE _____

Please indicate identification no. in case of replacement order

Performance and Dimensions

TYPES	1 Energy capacity Nm/cycle	1 Reacting Force N	Return Force		Stroke mm	A max. mm	B mm	D mm	E max. mm	Mounting Style	
			min. N	max. N						F and R Weight kg	S Weight kg
SDH63-100EU	19,100	210,000	1,500	2,500	100	420	301	252	144	32	35
SDH63-150EU	28,600	210,000	1,500	2,500	150	520	351	302	194	35	38
SDH63-200EU	38,200	210,000	1,500	2,500	200	620	401	352	244	39	42
SDH63-250EU	47,700	210,000	1,500	2,500	250	720	451	402	294	43	46
SDH63-300EU	57,300	210,000	1,500	2,500	300	850	531	482	344	48	51
SDH63-350EU	66,800	210,000	1,500	2,500	350	950	581	532	394	52	55
SDH63-400EU	76,400	210,000	1,500	2,500	400	1,080	661	612	444	60	63
SDH63-500EU	95,500	210,000	1,500	2,500	500	1,280	761	712	544	68	71
SDH63-600EU	114,500	210,000	1,500	2,500	600	1,510	891	842	644	78	81
SDH63-700EU	133,600	210,000	1,500	2,500	700	1,740	1,021	972	744	88	91
SDH63-800EU	152,700	210,000	1,500	2,500	800	1,970	1,151	1,102	844	98	101
SDH63-1000EU	190,900	210,000	1,500	2,500	1,000	2,430	1,411	1,362	1,044	118	121
SDH63-1200EU	229,100	210,000	1,500	2,500	1,200	2,890	1,671	1,622	1,244	138	141

1 The values apply to mounting style Front Flange and Foot Mounting. For mounting style Rear Flange, please consult ACE.
In case of an existing side load angle, please consult ACE.

SDP63 to SDP160

High return forces with gas pressure accumulator

Crane Installations, Optimized Characteristic
Energy capacity 9,100 Nm/Cycle to 582,000 Nm/Cycle
Stroke 50 mm to 1,200 mm

Reliability: The emergency stop from the large scale SDP63 to SDP160 series have internal system seals. Even dirt or damages to the piston rod do not lead to a leakage or failure. Compressed gas accumulators allow return forces of up to 100 kN, which can make applications in multiple bridge crane systems safer, for example. The absorber body and the robust, large-sized piston rod bearing are also designed for heavy duty operations

Just like all ACE safety shock absorbers, the characteristic curve or damping characteristics of each individual absorber is individually adjusted to the respective application.

Whether its crane systems or machines in heavy duty applications e.g. in the metal industry or in mining, these powerful safety shock absorbers reliably protect construction designs against expensive failure.

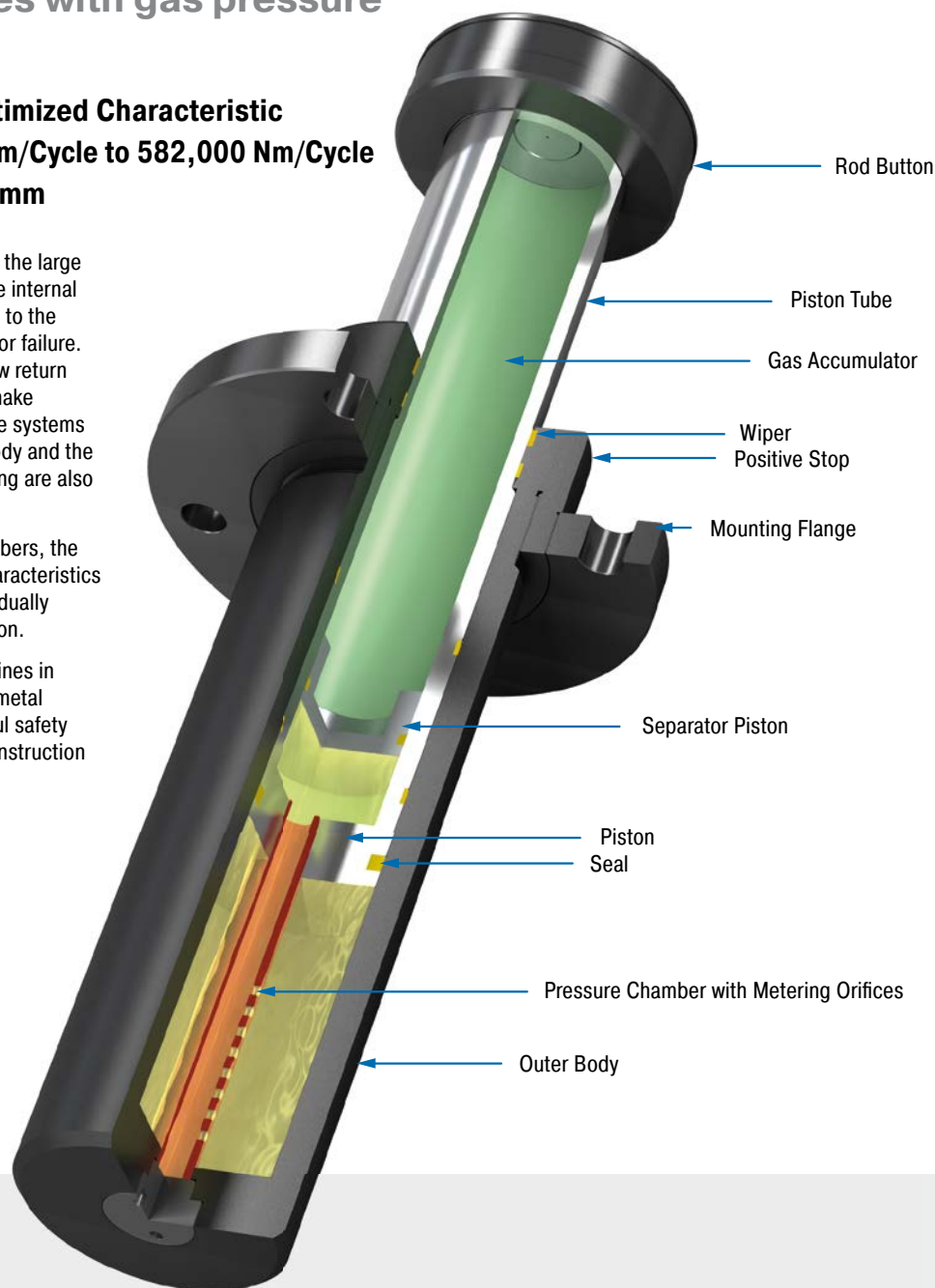

Technical Data

Energy capacity: 9,100 Nm/Cycle to 582,000 Nm/Cycle

Impact velocity range: 0.5 m/s to 4.6 m/s. Other speeds on request.

Reacting force: At max. capacity rating = 110 kN to 1.000 kN

Operating temperature range: -20 °C to +60 °C. Other temperatures on request.

Mounting: In any position

Positive stop: Integrated

Material: Outer body: Painted steel; Rod end button: Steel; Piston tube: Hard chrome plated steel

Damping medium: HLP 46

Filling pressure: Approx. 5 bar. Rod return by integrated nitrogen accumulator.

Application field: Shelf storage systems, Heavy load applications

Note: The shock absorber can be pushed through its stroke. In creep speed conditions the shock absorber provides minimal resistance and there is no braking effect.

On request: Special oils, special flanges, additional corrosion protection etc.

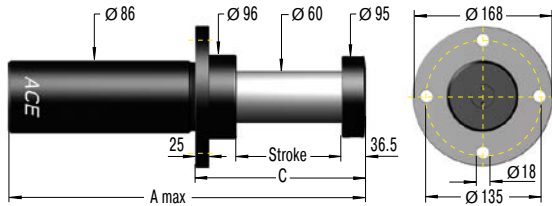
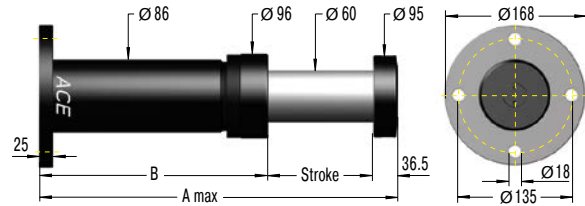
SDP63EU-F Front Flange

SDP63EU-R Rear Flange

Technical Data
Impact velocity range: 0.5 m/s to 4.6 m/s. Other speeds on request.

The calculation and selection of the most suitable damper should be carried out or be approved by ACE.
Complete details required when ordering

- Moving load: m (kg)
- Impact velocity range: v (m/s) max.
- Creep speed: vs (m/s)
- Motor power: P (kW)
- Stall torque factor: ST (normal, 2.5)
- (Alternatively: Propelling force F (N))
- Number of absorbers in parallel: n

or technical data according to formulae and calculations on page 265.

Ordering Example

SDP63-400EU-F-XXXXX

Safety Shock Absorber _____
 Bore Size Ø 63 mm _____
 Stroke 400 mm _____
 EU Compliant _____
 Mounting Style: Front Flange _____
 Identification No. assigned by ACE _____

Please indicate identification no. in case of replacement order
Performance and Dimensions

TYPES	Energy capacity Nm/cycle	Reacting Force N	Return Force min. N	Return Force max. N	Stroke mm	A max. mm	B mm	C mm	Weight kg
SDP63-50EU	9,100	200,000	1,500	8,000	50	280	193.5	145	11
SDP63-75EU	13,600	200,000	1,500	10,000	75	360	248.5	170	12.5
SDP63-100EU	18,200	200,000	1,500	11,000	100	425	288.5	195	14
SDP63-150EU	27,300	200,000	1,500	15,000	150	560	373.5	245	17
SDP63-200EU	36,400	200,000	1,500	17,000	200	700	463.5	295	19
SDP63-250EU	43,200	190,000	1,500	18,000	250	840	553.5	345	21
SDP63-300EU	49,100	180,000	1,500	20,000	300	980	643.5	395	24
SDP63-400EU	54,500	150,000	1,500	20,000	400	1,265	828.5	495	29
SDP63-500EU	59,100	130,000	1,500	20,000	500	1,555	1,018.5	595	34
SDP63-600EU	60,000	110,000	1,500	20,000	600	1,840	1,203.5	695	39

In case of an existing side load angle, please consult ACE.

SDP80EU-F Front Flange

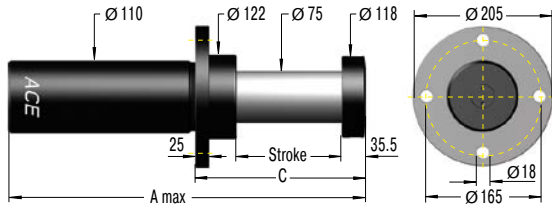

SDP80EU-R Rear Flange

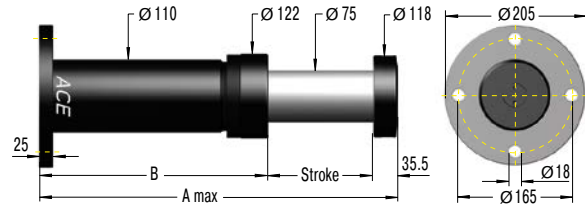

Technical Data

Impact velocity range: 0.5 m/s to 4.6 m/s. Other speeds on request.

The calculation and selection of the most suitable damper should be carried out or be approved by ACE.

Complete details required when ordering

- Moving load: m (kg)
- Impact velocity range: v (m/s) max.
- Creep speed: vs (m/s)
- Motor power: P (kW)
- Stall torque factor: ST (normal, 2.5)
- (Alternatively: Propelling force F (N))
- Number of absorbers in parallel: n

or technical data according to formulae and calculations on page 265.

Ordering Example

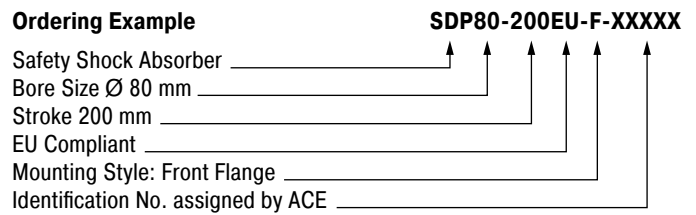

Please indicate identification no. in case of replacement order

Performance and Dimensions

TYPES	Energy capacity Nm/cycle	Reacting Force N	Return Force min. N	Return Force max. N	Stroke mm	A max. mm	B mm	C mm	Weight kg
SDP80-50EU	11,800	260,000	2,500	16,000	50	285	199.5	155	19
SDP80-100EU	23,600	260,000	2,500	16,000	100	440	304.5	205	23
SDP80-150EU	35,500	260,000	2,500	20,000	150	580	394.5	255	27
SDP80-200EU	47,300	260,000	2,500	20,000	200	730	494.5	305	32
SDP80-250EU	56,800	250,000	2,500	25,000	250	865	579.5	355	35
SDP80-300EU	65,500	240,000	2,500	25,000	300	1,010	674.5	405	39
SDP80-400EU	80,000	220,000	2,500	30,000	400	1,285	849.5	505	47
SDP80-500EU	90,900	200,000	2,500	30,000	500	1,575	1,039.5	605	55
SDP80-600EU	98,200	180,000	2,500	30,000	600	1,865	1,229.5	705	64
SDP80-800EU	101,800	140,000	2,500	30,000	800	2,450	1,614.5	905	80

In case of an existing side load angle, please consult ACE.

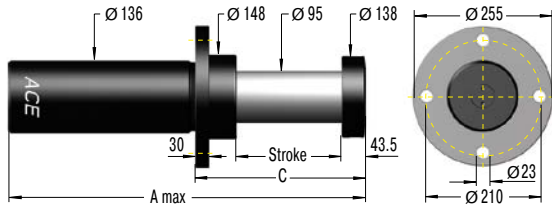
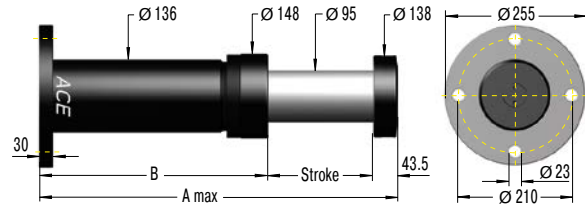
SDP100EU-F Front Flange

SDP100EU-R Rear Flange

Technical Data
Impact velocity range: 0.5 m/s to 4.6 m/s. Other speeds on request.

The calculation and selection of the most suitable damper should be carried out or be approved by ACE.
Complete details required when ordering

- Moving load: m (kg)
- Impact velocity range: v (m/s) max.
- Creep speed: vs (m/s)
- Motor power: P (kW)
- Stall torque factor: ST (normal, 2.5)
- (Alternatively: Propelling force F (N))
- Number of absorbers in parallel: n

or technical data according to formulae and calculations on page 265.

Ordering Example

SDP100-400EU-F-XXXX

Safety Shock Absorber _____ ↑

Bore Size Ø 100 mm _____ ↑

Stroke 400 mm _____ ↑

EU Compliant _____ ↑

Mounting Style: Front Flange _____ ↑

Identification No. assigned by ACE _____ ↑

Please indicate identification no. in case of replacement order
Performance and Dimensions

TYPES	Energy capacity Nm/cycle	Reacting Force N	Return Force min. N	Return Force max. N	Stroke mm	A max. mm	B mm	C mm	Weight kg
SDP100-100EU	47,000	520,000	3,900	38,000	100	460	316.5	230	38
SDP100-200EU	95,000	520,000	3,900	38,000	200	750	506.5	330	53
SDP100-250EU	114,000	520,000	3,900	40,000	250	890	596.5	380	59
SDP100-300EU	131,000	500,000	3,900	40,000	300	1,035	691.5	430	66
SDP100-400EU	160,000	480,000	3,900	40,000	400	1,325	881.5	530	81
SDP100-500EU	182,000	440,000	3,900	40,000	500	1,610	1,066.5	630	93
SDP100-600EU	196,000	360,000	3,900	46,000	600	1,880	1,236.5	730	103
SDP100-800EU	218,000	300,000	3,900	46,000	800	2,450	1,606.5	930	125
SDP100-1000EU	236,000	260,000	3,900	46,000	1,000	3,020	1,976.5	1,130	160

In case of an existing side load angle, please consult ACE.

SDP120EU-F Front Flange

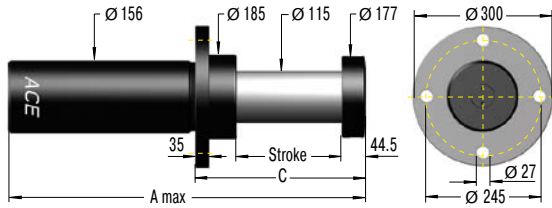

SDP120EU-R Rear Flange

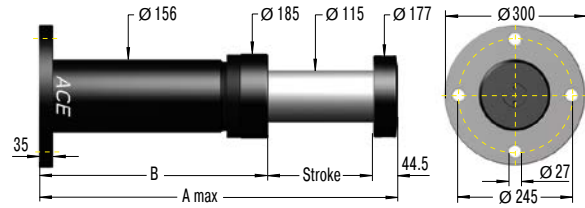

Technical Data

Impact velocity range: 0.5 m/s to 4.6 m/s. Other speeds on request.

The calculation and selection of the most suitable damper should be carried out or be approved by ACE.

Complete details required when ordering

- Moving load: m (kg)
- Impact velocity range: v (m/s) max.
- Creep speed: vs (m/s)
- Motor power: P (kW)
- Stall torque factor: ST (normal, 2.5)
- (Alternatively: Propelling force F (N))
- Number of absorbers in parallel: n

or technical data according to formulae and calculations on page 265.

Ordering Example

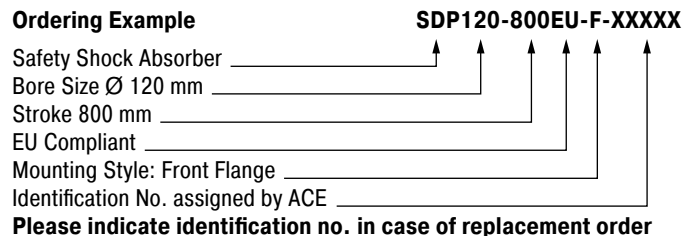

Please indicate identification no. in case of replacement order

Performance and Dimensions

TYPES	Energy capacity Nm/cycle	Reacting Force N	Return Force min. N	Return Force max. N	Stroke mm	A max. mm	B mm	C mm	Weight kg
SDP120-100EU	64,000	700,000	5,600	35,000	100	460	315.5	249	58
SDP120-200EU	127,000	700,000	5,600	70,000	200	750	505.5	355	72
SDP120-400EU	236,000	650,000	5,600	75,000	400	1,325	880.5	555	99
SDP120-600EU	300,000	550,000	5,600	75,000	600	1,880	1,235.5	755	125
SDP120-800EU	327,000	450,000	5,600	75,000	800	2,450	1,605.5	955	160
SDP120-1000EU	364,000	400,000	5,600	75,000	1,000	3,020	1,975.5	1,155	192
SDP120-1200EU	436,000	400,000	5,600	75,000	1,200	3,590	2,345.5	1,355	225

In case of an existing side load angle, please consult ACE.

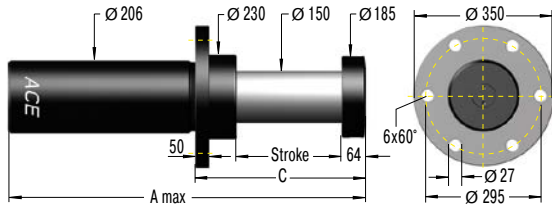
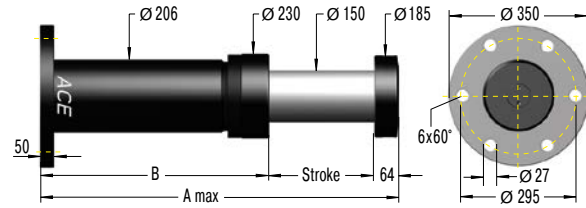
SDP160EU-F Front Flange

SDP160EU-R Rear Flange

Technical Data

Impact velocity range: 0.5 m/s to 4.6 m/s. Other speeds on request.

The calculation and selection of the most suitable damper should be carried out or be approved by ACE.

Complete details required when ordering

- Moving load: m (kg)
- Impact velocity range: v (m/s) max.
- Creep speed: vs (m/s)
- Motor power: P (kW)
- Stall torque factor: ST (normal, 2.5)
- (Alternatively: Propelling force F (N))
- Number of absorbers in parallel: n

or technical data according to formulae and calculations on page 265.

Ordering Example
SDP160-400EU-F-XXXXX

- Safety Shock Absorber _____
- Bore Size Ø 160 mm _____
- Stroke 400 mm _____
- EU Compliant _____
- Mounting Style: Front Flange _____
- Identification No. assigned by ACE _____

Please indicate identification no. in case of replacement order

Performance and Dimensions

TYPES	Energy capacity Nm/cycle	Reacting Force N	Return Force min. N	Return Force max. N	Stroke mm	A max. mm	B mm	C mm	Weight kg
SDP160-200EU	182,000	1,000,000	1,000	80,000	200	860	596	440	105
SDP160-400EU	345,000	950,000	1,000	80,000	400	1,485	1,021	640	165
SDP160-500EU	409,000	900,000	1,000	90,000	500	1,765	1,201	740	195
SDP160-600EU	469,000	860,000	1,000	95,000	600	2,065	1,401	840	230
SDP160-800EU	545,000	750,000	1,000	100,000	800	2,660	1,796	1,040	290
SDP160-1000EU	545,000	600,000	1,000	110,000	1,000	3,225	2,161	1,240	350
SDP160-1200EU	545,000	500,000	1,000	110,000	1,200	3,815	2,551	1,440	410
SDP160-1600EU	582,000	400,000	1,000	110,000	1,600	4,995	3,331	1,840	530

In case of an existing side load angle, please consult ACE.

Permitted Use

ACE safety shock absorbers are machine elements to brake moving masses in a defined end position in emergency stop situations for axial forces. The safety shock absorbers are not designed for regular operational usage.

Calculation of safety shock absorbers

The calculation of safety shock absorbers should generally be performed or checked by ACE.

Deceleration Properties

The orifice sizing and drill pattern in the pressure chamber are individually designed for each safety shock absorber. The respective absorption characteristic is optimised corresponding to the maximum mass that occurs in the emergency stop and the impact speed. Correspondingly, each safety shock absorber is given an individual identification number.

Model Code

For types SCS33 to 64, the individual five-digit identification numbers can be taken from the last digits of the shock absorber model code shown on the label. Example: SCS33-50EU-1XXXX. For type series SDH38 to SDH63 and SDP63 to SDP160, the identification number is a five digit number. Example: SDH38-400EU-F-XXXXX. In addition to the model code, the label also shows the authorised maximum impact velocity and maximum authorised impact mass for the unit.

Mounting

To mount the shock absorber, we recommend the use of original ACE mounting accessories shown in catalogue.

The mounting of each shock absorber must be exactly positioned so that the reaction force (Q) can be adequately transmitted into the mounting structure.

ACE recommends installation via the front flange -F mounting style that ensures the maximum protection against buckling. The damper must be mounted so that the moving loads are decelerated with the least possible side loading to the piston rod. The maximum permissible side load angles are detailed in our current catalogue.

The entire stroke length must be used for deceleration because only using part of the stroke can lead to overstressing and damage to the unit.

Mounting style front flange



Safety Shock Absorber SDH



Safety Shock Absorber SDP

Environmental Requirements

The permissible **temperature range** for each shock absorber type can be found in our current catalogue.

Caution: Usage outside the specified temperature range can lead to premature breakdown and damage of the shock absorbers which can then result in severe system damage or machine failures.

Trouble free operation outdoors or in damp environments is only warranted if the dampers are coated with a specific corrosion protection finish.

Initial Start-Up Checks

First impacts on the shock absorber should only be tried after correctly mounting and with reduced impact speeds and – if possible – with reduced load. Differences between calculated and actual operating data can then be detected early on, and damage to your system can be avoided. If the shock absorbers were selected on calculated data that does not correspond to the maximum possible loading (i.e. selection based on drive power being switched off or at reduced impact speed) then these restricted impact conditions must not be exceeded during initial testing or subsequent use of the system. Otherwise you risk damaging the shock absorbers and/or your machine by overstressing materials. After the initial trial check that the piston rod fully extends again and that there are no signs of oil leakage. Also check that the mounting hardware is still securely tightened. You need to satisfy yourself that no damage has occurred to the piston rod, the body, or the mounting hardware.

Fixed Mechanical Stop

Safety shock absorbers do not need an external stop as a stroke limiter. The stroke of the safety absorber is limited by the stop of the impact head on the shock absorber. For types SCS33 to SCS64, the fixed stop point is achieved with the integrated stop collar.

What Needs to be Checked after a Full Load Impact?

Safety shock absorbers that were originally checked only at reduced speed or load need to be checked again after a full load impact (i.e. emergency use) has occurred. Check that the piston rod fully extends to its full out position, that there are no signs of oil leakage and that the mounting hardware is still securely fixed. You need to satisfy yourself that no damage has occurred to the piston rod, the body, or the mounting hardware. If no damage has occurred, the safety shock absorber can be put back into normal operation (see **initial start-up**).

Maintenance

Safety shock absorbers are sealed systems and do not need special maintenance. Safety shock absorbers that are not used regularly (i.e. that are intended for emergency stop systems) should be checked within the normal time frame for safety checks, but **at least once a year**. At this time special attention must be paid to checking that the piston rod resets to its fully extended position, that there is no oil leakage and that the mounting brackets are still secure and undamaged. The piston rod must not show any signs of damage. Safety shock absorbers that are **in use regularly** should be checked **every three months**.

Repair Notice

If any damage to the shock absorber is detected or if there are any doubts as to the proper functioning of the unit please send the unit for service to ACE. Alternatively contact your local ACE office for further advice.

Detailed information on the above listed points can be taken from the corresponding operating and assembly instructions.

Calculation Bases for the Design of Safety Shock Absorbers

More formulae on page 10 to 13

ACE shock absorbers provide linear deceleration and are therefore superior to other kinds of damping element. It is easy to calculate around 90 % of applications knowing only the following four parameters:

1. Mass to be decelerated (weight) **m** [kg]
2. Impact velocity at shock absorber **v_D** [m/s]
3. Propelling force **F** [N]
4. Number of absorbers in parallel **n**

Key to symbols used

W_1	Kinetic energy per cycle	Nm	2v_D	Impact velocity at shock absorber	m/s
W_2	Propelling force energy per cycle	Nm	F	Propelling force	N
W_3	Total energy per cycle ($W_1 + W_2$)	Nm	c	Cycles per hour	1/hr
1W_4	Total energy per hour ($W_3 \cdot x$)	Nm/hr	s	Shock absorber stroke	m
me	Effective weight	kg	Q	Reaction force	N
m	Mass to be decelerated	kg	t	Deceleration time	s
n	Number of shock absorbers (in parallel)		a	Deceleration	m/s ²
2v	Velocity at impact	m/s			

¹ All mentioned values of W4 in the capacity charts are only valid for room temperature. There are reduced values at higher temperature ranges.

² v or v_D is the final impact velocity of the mass. With accelerating motion the final impact velocity can be 1.5 to 2 times higher than the average. Please take this into account when calculating kinetic energy.

In all the following examples the choice of shock absorbers made from the capacity chart is based upon the values of (W_3), (W_4), (me) and the desired shock absorber stroke (s).

Note: When using several shock absorbers in parallel, the values (W_3), (W_4) and (me) are divided according to the number of units used.

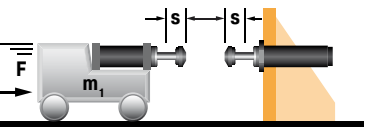
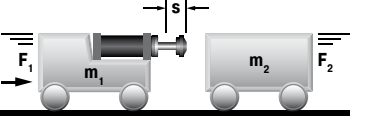
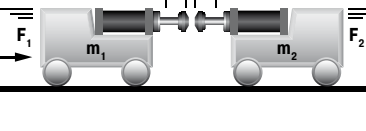
Application	Formulae	Example																		
19 Wagon against 2 shock absorbers 	$W_1 = m \cdot v^2 \cdot 0.25$ $W_2 = F \cdot s$ $W_3 = W_1 + W_2$ $v_D = v \cdot 0.5$	<table border="0"> <tr> <td>m = 5000 kg</td> <td>$W_1 = 5000 \cdot 2^2 \cdot 0.25$</td> <td>= 5000 Nm</td> </tr> <tr> <td>v = 2 m/s</td> <td>$W_2 = 3500 \cdot 0.10$</td> <td>= 350 Nm</td> </tr> <tr> <td>F = 3500 N</td> <td>$W_3 = 5000 + 350$</td> <td>= 5350 Nm</td> </tr> <tr> <td>s = 0.10 m (chosen)</td> <td>$v_D = 2 \cdot 0.5$</td> <td>= 1 m/s</td> </tr> </table> <p>Chosen from capacity chart: Model SDH38-100EU self-compensating</p>	m = 5000 kg	$W_1 = 5000 \cdot 2^2 \cdot 0.25$	= 5000 Nm	v = 2 m/s	$W_2 = 3500 \cdot 0.10$	= 350 Nm	F = 3500 N	$W_3 = 5000 + 350$	= 5350 Nm	s = 0.10 m (chosen)	$v_D = 2 \cdot 0.5$	= 1 m/s						
m = 5000 kg	$W_1 = 5000 \cdot 2^2 \cdot 0.25$	= 5000 Nm																		
v = 2 m/s	$W_2 = 3500 \cdot 0.10$	= 350 Nm																		
F = 3500 N	$W_3 = 5000 + 350$	= 5350 Nm																		
s = 0.10 m (chosen)	$v_D = 2 \cdot 0.5$	= 1 m/s																		
20 Wagon against wagon 	$W_1 = \frac{m_1 \cdot m_2}{(m_1 + m_2)} \cdot (v_1 + v_2)^2 \cdot 0.5$ $W_2 = F \cdot s$ $W_3 = W_1 + W_2$ $v_D = v_1 + v_2$	<table border="0"> <tr> <td>m = 7000 kg</td> <td>$W_1 = \frac{7000 \cdot 10000}{(7000 + 10000)} \cdot 1.7^2 \cdot 0.5$</td> <td>= 5950 Nm</td> </tr> <tr> <td>v₁ = 1.2 m/s</td> <td>$W_2 = 5000 \cdot 0.10$</td> <td>= 500 Nm</td> </tr> <tr> <td>m₂ = 10000 kg</td> <td>$W_3 = 5950 + 500$</td> <td>= 6450 Nm</td> </tr> <tr> <td>v₂ = 0.5 m/s</td> <td>$v_D = 1.2 + 0.5$</td> <td>= 1.7 m/s</td> </tr> <tr> <td>F = 5000 N</td> <td></td> <td></td> </tr> <tr> <td>s = 0.10 m (chosen)</td> <td></td> <td></td> </tr> </table> <p>Chosen from capacity chart: Model SDH50-100EU self-compensating</p>	m = 7000 kg	$W_1 = \frac{7000 \cdot 10000}{(7000 + 10000)} \cdot 1.7^2 \cdot 0.5$	= 5950 Nm	v ₁ = 1.2 m/s	$W_2 = 5000 \cdot 0.10$	= 500 Nm	m ₂ = 10000 kg	$W_3 = 5950 + 500$	= 6450 Nm	v ₂ = 0.5 m/s	$v_D = 1.2 + 0.5$	= 1.7 m/s	F = 5000 N			s = 0.10 m (chosen)		
m = 7000 kg	$W_1 = \frac{7000 \cdot 10000}{(7000 + 10000)} \cdot 1.7^2 \cdot 0.5$	= 5950 Nm																		
v ₁ = 1.2 m/s	$W_2 = 5000 \cdot 0.10$	= 500 Nm																		
m ₂ = 10000 kg	$W_3 = 5950 + 500$	= 6450 Nm																		
v ₂ = 0.5 m/s	$v_D = 1.2 + 0.5$	= 1.7 m/s																		
F = 5000 N																				
s = 0.10 m (chosen)																				
21 Wagon against wagon 2 shock absorbers 	$W_1 = \frac{m_1 \cdot m_2}{(m_1 + m_2)} \cdot (v_1 + v_2)^2 \cdot 0.25$ $W_2 = F \cdot s$ $W_3 = W_1 + W_2$ $v_D = \frac{v_1 + v_2}{2}$	<table border="0"> <tr> <td>m = 7000 kg</td> <td>$W_1 = \frac{7000 \cdot 10000}{(7000 + 10000)} \cdot 1.7^2 \cdot 0.25$</td> <td>= 2975 Nm</td> </tr> <tr> <td>v₁ = 1.2 m/s</td> <td>$W_2 = 5000 \cdot 0.10$</td> <td>= 500 Nm</td> </tr> <tr> <td>m₂ = 10000 kg</td> <td>$W_3 = 2975 + 510$</td> <td>= 3475 Nm</td> </tr> <tr> <td>v₂ = 0.5 m/s</td> <td>$v_D = (1.2 + 0.5) : 2$</td> <td>= 0.85 m/s</td> </tr> <tr> <td>F = 5000 N</td> <td></td> <td></td> </tr> <tr> <td>s = 0.10 m (chosen)</td> <td></td> <td></td> </tr> </table> <p>Chosen from capacity chart: Model SDH38-100EU self-compensating</p>	m = 7000 kg	$W_1 = \frac{7000 \cdot 10000}{(7000 + 10000)} \cdot 1.7^2 \cdot 0.25$	= 2975 Nm	v ₁ = 1.2 m/s	$W_2 = 5000 \cdot 0.10$	= 500 Nm	m ₂ = 10000 kg	$W_3 = 2975 + 510$	= 3475 Nm	v ₂ = 0.5 m/s	$v_D = (1.2 + 0.5) : 2$	= 0.85 m/s	F = 5000 N			s = 0.10 m (chosen)		
m = 7000 kg	$W_1 = \frac{7000 \cdot 10000}{(7000 + 10000)} \cdot 1.7^2 \cdot 0.25$	= 2975 Nm																		
v ₁ = 1.2 m/s	$W_2 = 5000 \cdot 0.10$	= 500 Nm																		
m ₂ = 10000 kg	$W_3 = 2975 + 510$	= 3475 Nm																		
v ₂ = 0.5 m/s	$v_D = (1.2 + 0.5) : 2$	= 0.85 m/s																		
F = 5000 N																				
s = 0.10 m (chosen)																				

Application Examples

SCS45EU

Controlled emergency stop

ACE safety shock absorbers protect precision assembly jigs for the aircraft industry. The basic mount of this coordinate measuring machine for the production of parts in the aircraft industry is made of granite and must not be damaged. To avoid damage from operating errors or mishandling, all movement axes were equipped with safety shock absorbers of the type SCS45-50EU. If the turntables malfunction the safety shock absorbers decelerate the loads before expensive damage can occur to the granite measuring tables.



Optimally protected turntable

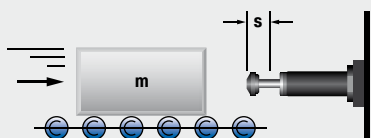

SCS33EU, SCS45EU

High-level protection of linear modules

Safety shock absorbers produced by ACE are installed in the top linear system models of one of the most prestigious companies in the field of drive and control technology. Their job: to protect the z-axis from damage caused by uncontrolled movements. Various safety dampers are used for different load ranges. Tests have shown that, in the worst case, a collision speed of up to 5 m/s might occur. To be on the safe side, the interpretations were based in all cases on a slightly higher value.



For protecting equipment and modules such as these, the SCS series from ACE is the ideal solution in the emergency stop sector
Roth GmbH & Co. KG, 90411 Nürnberg, Germany and Bosch Rexroth AG, 97816 Lohr am Main, Germany

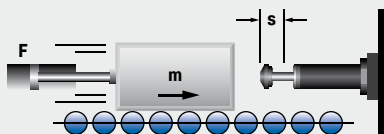

SDP160EU

Customized buffer beam dampers

Driving into lock gates should be specifically facilitated when navigating through Dutch river locks. That is why ACE developed special dampers, based on existing safety shock absorbers but with optimized characteristics, a fixed stop and a stroke of 800 mm. These are able to absorb 500,000 Nm, which means they can cope with fully loaded ships and also the mechanical impacts resulting from water movement. To return to the initial position, the safety shock absorbers operate on the same nitrogen-based principle as the gas springs produced by the damping specialists in Langenfeld.

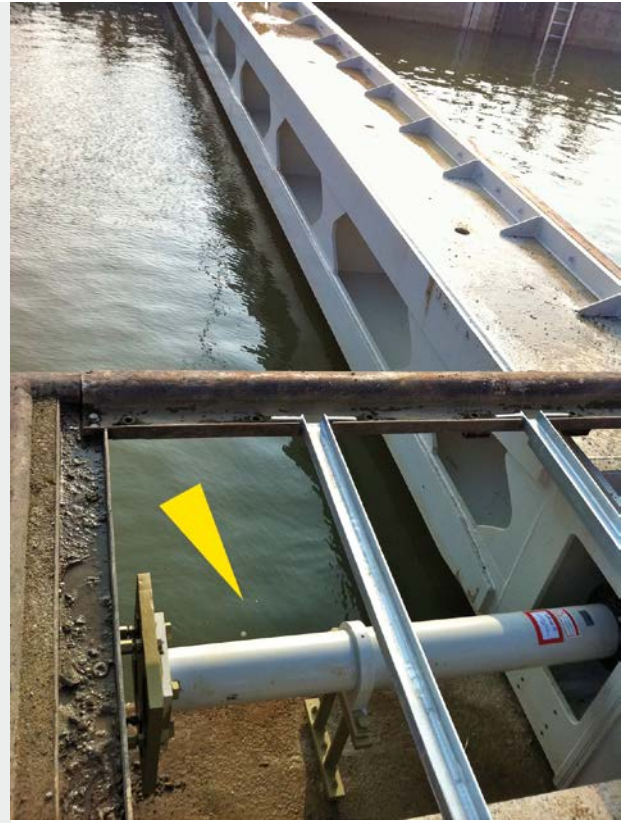
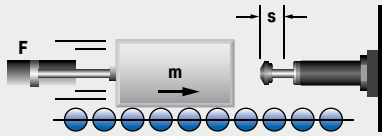

Heavy safety shock absorbers, which are specially designed for this application, are able to brake in lock masses of up to four million kg
Mourik Limburg BV, 6101 AJ Echt, Netherlands

SDH38EU

Safe driving to the end positions

The aim was to protect a driving simulation capsule on two of its eight axes. The demands placed on a potential emergency stopper were high because it was clear that its failure would lead to massive damage to the complete construction as well as to the capsule. Even the possibility of damage to the health of the test personnel could not be ruled out and was taken into consideration in a diverse range of mass-speed combinations. Two ACE safety shock absorbers now safely contain destructive forces, e.g. during power outages, and eliminate high risks.

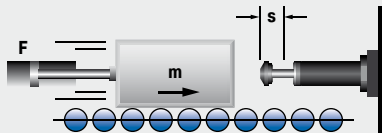

ACE safety shock absorbers protect end positions in two axes of a driving simulator
Bosch Rexroth BV, Boxel 5281 RV, The Netherlands
and University of Stuttgart - FKFS, 70569 Stuttgart, Germany

Issue 07.2017 – Specifications subject to change

Safety Dampers

Top for emergency stopping

The extremely successful TUBUS series from ACE is suitable for emergency stopping, as overrun protection or as end stop dampers. Available in different variations for heavy duty or crane installations, these profile dampers are perfect when loads do not need to be instantly decelerated or when working under extreme conditions.

Manufactured in co-polyester elastomer, the highly resistant absorbers provide high force and energy absorption in areas where other materials fail or where a similarly high service life of up to 1 million load changes cannot be achieved. They are cost-effective and distinguished by the small, light design. With energy absorption within a range of 450 Nm and 17,810 Nm, they can be considered as an alternative to hydraulic end position damping.



Safety Dampers



TUBUS TC and TC-S

Page 270

Crane Installations

Compact powerhouse

Crane systems, Loading and lifting equipment, Hydraulic devices,
Electro-mechanical drives



TUBUS TI

Page 272

Irreversible Emergency Stop Damper

Compact one-off deceleration

Emergency stop damping in linear axes, Portal systems, Test stations,
Electro-mechanical drives

Extremely durable

Highly resistant co-polyester elastomers

Lightweight designs

Cost-effective use

Heavy-duty versions available



TUBUS TC and TC-S

Compact powerhouse

Crane Installations

Energy capacity 630 Nm/Cycle to 17,810 Nm/Cycle

Maximum stroke 30 mm to 198 mm

For even more protection: The profile dampers from the TC range of the ACE TUBUS-Series can also be used as safety dampers. These maintenance-free, ready-to-install damping elements made of co-polyester elastomer have been specially developed for use in crane systems and fulfil the international industry standards OSHA and CMAA. In the special TC-S design, managed to achieve the spring rate required for crane systems with the unique dual concept.

Whether TC-S or TC, this range of models represents a cost-effective solution with high energy absorption for energy management systems. The very small and light design of Ø 64 mm to Ø 176 mm progressively covers energy absorption within a range of 450 Nm to 17,810 Nm.

The profile dampers from the TC range protect cranes, loading and lifting equipment, hydraulic units and much more.



Technical Data

Energy capacity: 630 Nm/Cycle to 17,810 Nm/Cycle

Energy absorption: 31 % to 64 %

Dynamic force range: 80,000 N to 978,000 N

Operating temperature range: -40 °C to +90 °C

Construction size: 64 mm to 176 mm

Material hardness rating: Shore 55D

Material: Profile body: Co-Polyester Elastomer

Mounting: In any position

Environment: Resistant to microbes, seawater or chemical attack. Excellent UV and ozone resistance. Material does not absorb water or swell.

Impact velocity range: Max. 5 m/s

Torque max.:

M12: 50 Nm

M16: 40 Nm (DIN912)

M16: 120 Nm (shouldered screw)

Application field: Crane systems, Loading and lifting equipment, Hydraulic devices, Electro-mechanical drives

Note: Suitable for emergency stop applications and for continuous use. For applications with preloading and increased temperatures please consult ACE.

On request: Special strokes, -characteristics, -spring rates, -sizes and -materials.

TC

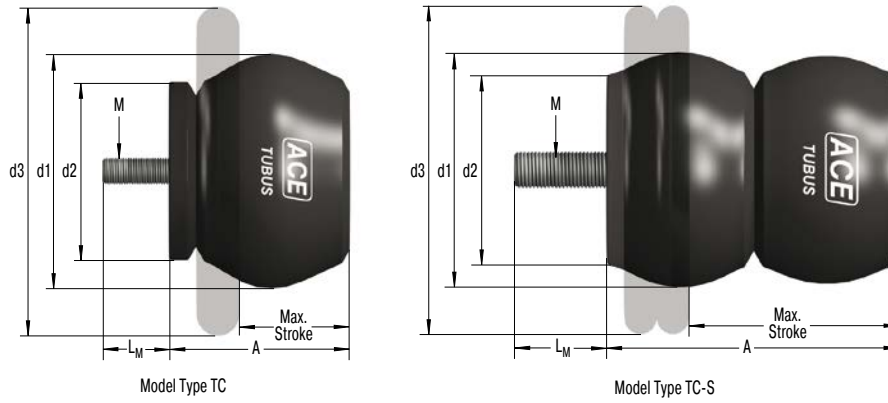

Characteristics

Type TC90-49
Energy-Stroke Characteristic (dynamic)
(with impact velocity over 0.5 m/s)

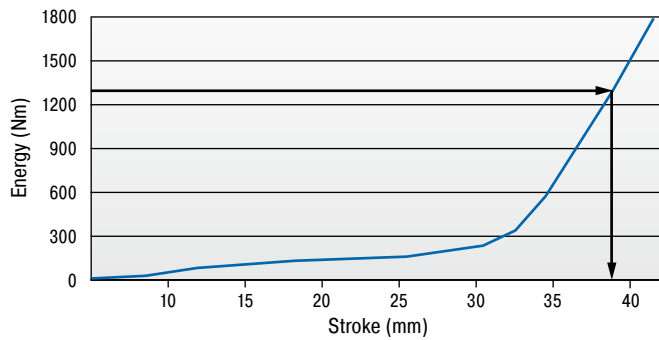

Type TC90-49
Force-Stroke Characteristic (dynamic)
(with impact velocity over 0.5 m/s)

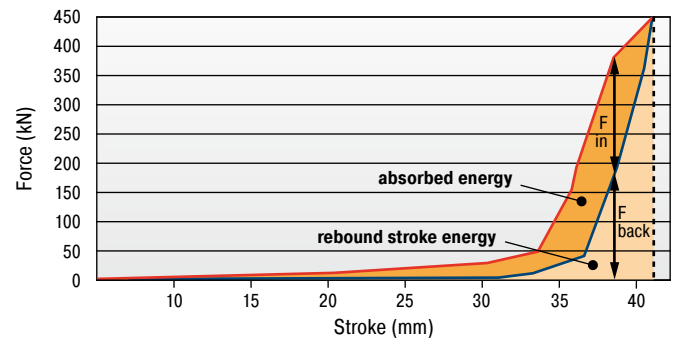

With the aid of the characteristic curves above you can estimate the proportion of the total energy that will be absorbed.

Example: With impact energy of 1,300 Nm the Energy-Stroke diagram shows that a stroke of about 38 mm is needed.

On the Force-Stroke diagram you can estimate the proportion of absorbed energy to rebound energy at this stroke length.

Note: With these types the return force towards the end of the stroke is significant and we recommend you try to use a minimum of 90 % of the total stroke available.

Dynamic ($v > 0.5$ m/s) and static ($v \leq 0.5$ m/s) characteristics of all types are available on request.

The calculation and selection of the most suitable damper should be carried out or be approved by ACE.

Ordering Example

TUBUS Crane Buffer _____ **TC83-73-S**
 Outer-Ø 83 mm _____
 Stroke 73 mm _____
 Model Type Soft _____

Performance and Dimensions

TYPES	Emergency Stop		Stroke max. mm	A mm	d1 mm	d2 mm	d3 mm	L _M mm	M	Weight kg
	¹ W ₃ Nm/cycle	W ₃ Nm/cycle								
TC64-62-S	450	630	62	79	64	52	89	12	M12	0.174
TC74-76-S	980	1,372	76	96	74	61	114	12	M12	0.260
TC83-73-S	1,940	2,715	73	94	83	69	127	12	M12	0.328
TC86-39	1,210	1,695	39	56	86	78	133	12	M12	0.284
TC90-49	1,640	2,295	49	68	90	67	124	12	M12	0.264
TC100-59	1,785	2,500	59	84	100	91	149	12	M12	0.452
TC102-63	1,970	2,760	63	98	102	82	140	22	M16	0.662
TC108-30	1,900	2,660	30	53	108	77	133	12	M12	0.392
TC117-97	3,710	5,195	97	129	117	100	188	16	M16	1.043
TC134-146-S	7,310	10,230	146	188	134	117	215	30	M16	1.573
TC136-65	4,250	5,950	65	106	136	106	178	16	M16	1.147
TC137-90	6,350	8,890	90	115	137	113	216	21	M16	1.201
TC146-67-S	8,330	11,660	67	118	146	99	191	16	M16	1.573
TC150-178-S	8,860	12,400	178	241	150	132	224	16	M16	2.674
TC153-178-S	7,260	10,165	178	226	153	131	241	16	M16	2.522
TC168-124	10,100	14,140	124	166	168	147	260	16	M16	2.533
TC176-198-S	12,725	17,810	198	252	176	150	279	16	M16	3.685

¹ Max. energy capacity per cycle for continuous use.

TUBUS TI

Compact one-off deceleration

Irreversible Emergency Stop Damper

Energy capacity 562 Nm/Cycle to 10,953 Nm/Cycle

Maximum stroke 25 mm to 80 mm

Once only, but safely: ACE now offers these innovative single use TUBUS TI absorbers for emergency stop applications as an alternative to the successful TUBUS profile dampers. In comparison to standard elastomer absorbers, these safety dampers ensure energy absorption of up to 96 % without a recoil effect. The dampers are deformed in the impact and cannot be reused afterwards.

The easy to assemble and maintenance-free single hit damper are also a cost-effective alternative to the hydraulic safety shock absorbers from ACE. They are made of a high quality synthetic with an inside metal core and absorb up to 10,953 Nm energy.

The TUBUS TI is mainly used as emergency stop damping in linear axes, tool machines, servo drives with high speeds and other similar areas.

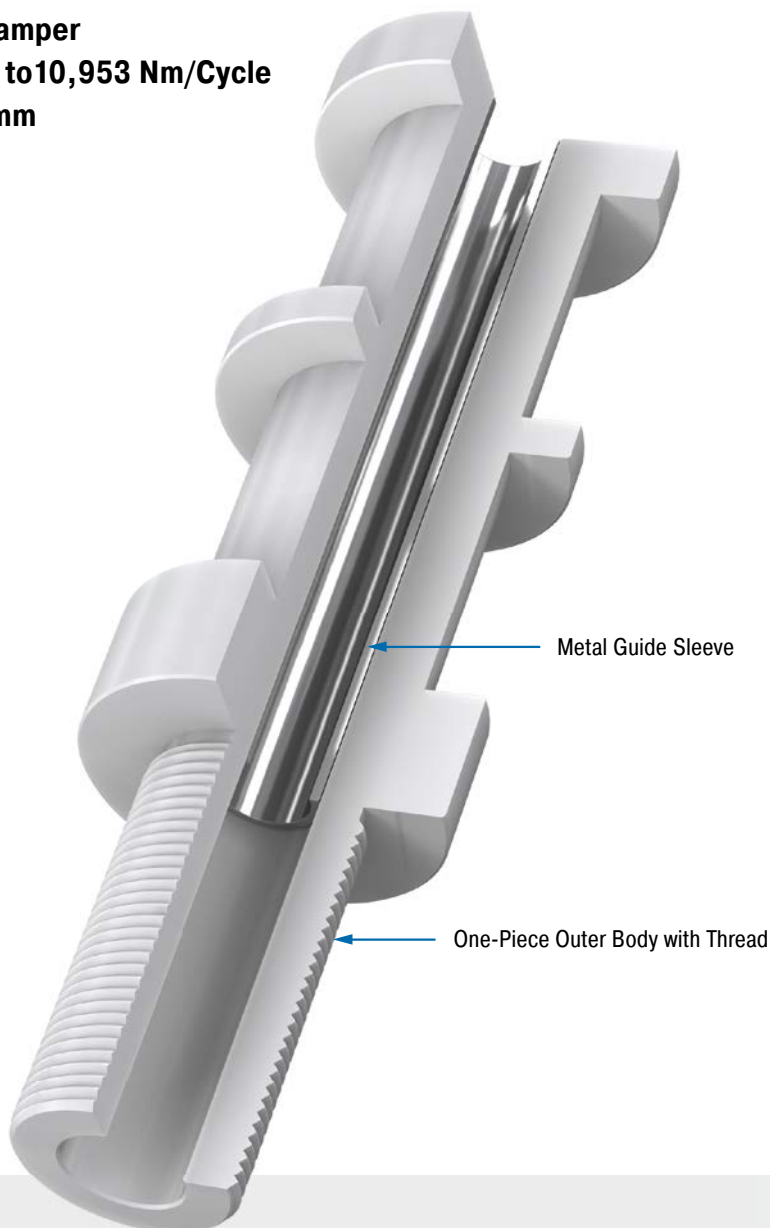

Technical Data

Energy capacity: 562 Nm/Cycle to 10,953 Nm/Cycle

Energy absorption: 91 % to 96 %

Dynamic force range: 37,138 N to 204,127 N

Operating temperature range:

-40 °C to +90 °C, Co-polyester Elastomer
-25 °C to +50 °C, Polymer

Construction size: 32 mm to 63 mm

Material: Profile body: Co-Polyester elastomer or polymer; Guide sleeve: Metal

Mounting: In any position

Environment: Resistant to lubricants and chemical attack according to resistance list. No UV resistance.

Impact velocity range: Max. 5 m/s

Torque max.: Finger tight

Application field: Emergency stop damping in linear axes, Portal systems, Test stations, Electro-mechanical drives

Note: The single-use damper must be replaced after each impact.

On request: Other construction sizes on request.

TI16

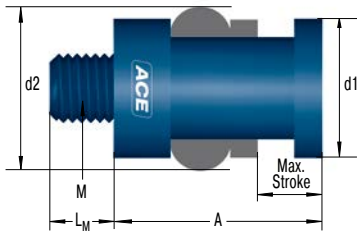

TI24

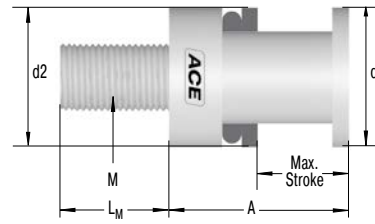

TI30

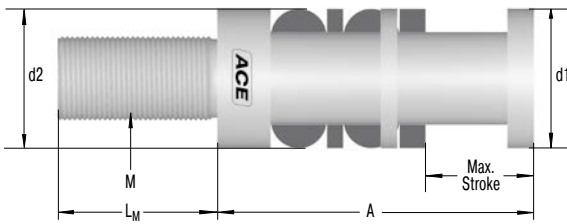

TI36

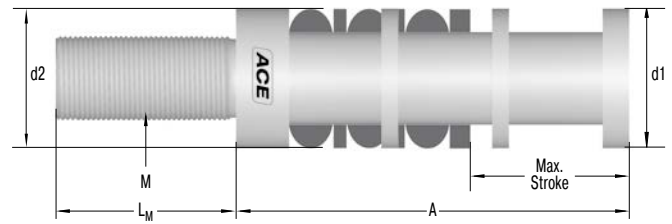

Characteristics

Force-Stroke TI16

Dynamic trials on a drop test rig

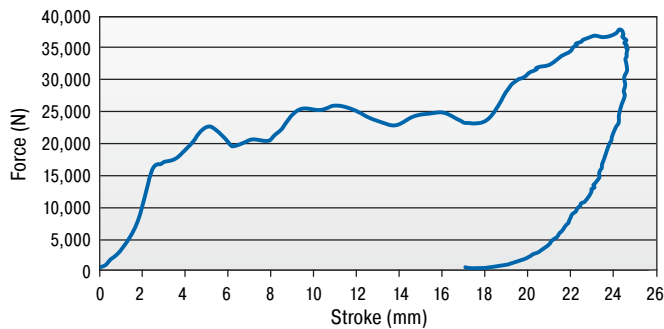

	TI16
Total energy:	562 Nm
Absorbed energy:	511 Nm
Efficiency:	91 %

Force-Stroke TI24, TI30 and TI36

Dynamic trials on a drop test rig

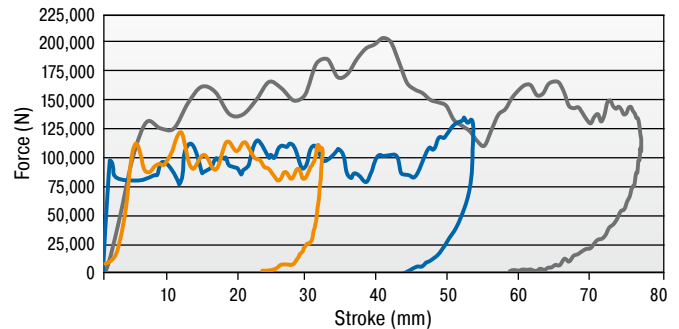

	TI36	TI30	TI24
Total energy:	10,954 Nm	4,510 Nm	2,701 Nm
Absorbed energy:	10,513 Nm	4,309 Nm	2,545 Nm
Efficiency:	96 %	96 %	94 %

The characteristic values have been established under dynamic load.

The calculation and selection of the most suitable damper should be carried out or be approved by ACE.

Ordering Example

TUBUS Irreversible _____ ↑ ↑ ↑ ↑
 Thread Size M16 _____ ↑ ↑ ↑ ↑
 Stroke 25 mm _____ ↑ ↑ ↑ ↑
 Number of Bellows _____ ↑ ↑ ↑ ↑

TI16-25-1

Performance and Dimensions

TYPES	Energy capacity emergency use Nm/cycle	Stroke max. mm	Reacting Force N	A mm	d1 mm	d2 mm	L _M mm	M	Depth thread hole min. mm	Weight kg
TI16-25-1	562	25	37,138	48	32	38	15	M16x2	25	0.045
TI24-33-1	2,701	33	113,590	64.5	50	50	40	M24x3	40	0.140
TI30-52-2	4,510	52	121,130	113	50	50	57	M30x3.5	63	0.240
TI36-80-3	10,953	80	204,127	172	63	65	89	M36x4	89	0.620

Clamping Elements

On-the-spot clamping and stopping in emergencies and other situations

Clamping elements from the LOCKED series also serve the purpose of safety. These ACE products clamp and decelerate loads and are suitable for perfectly controlled holding, both linear and rotary, in all processes.

Alongside ACE LOCKED solutions for conventional rail, rod or rotation clamping, special clamps with safety function for Z-axes, which reliably help secure axes with a gravitational load, are available in the LOCKED LZ-P series. The latter solution is available for both pneumatic operation and as an electric version. Whether Z-axes, linear guide, rod or rotation clamping, the choice is (typical of ACE) as large as the performance capacity of the products, which are compatible with the solutions of all standard manufacturers.



LOCKED by ACE. After all, safe is safe.

Increased process reliability

Available as clamping and emergency stop brakes

Very short stop distances

Very high clamping forces

Compact designs

Ideal for all standard sizes



Rail Clamping

For safe deceleration of rail-guided construction elements

Safe deceleration of a mass that is traversed with the help of a rail and guide rail and track carriage combination must be complied with and not only for safety reasons; reliable clamps in the production processes are also becoming increasingly important.

Both features can be taken care of by the clamping elements from ACE. All clamping elements work with the patented spring steel plate system.

This system achieves braking and clamping forces of up to 10,000 N. The clamping elements are always individually adapted to the used linear guide. They are available for all rail sizes and profiles for all renowned manufacturers.

Function of clamping elements LOCKED PL/SL/PLK/SLK

All process and safety clamps work with the reinforced spring steel plate system.

Compressed air is introduced between the two spring plates, which are connected with a surrounding rubber coating.

If pressure is applied, the clamping element can freely move; if the clamping element is vented clamping to the guide rail follows.

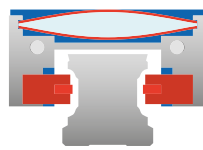

Clamping element ventilated

Released

The chamber filled with compressed air between the spring steel plates relaxes and thus releases the clamping/brake pads from the rail. The clamping element is now free to move.

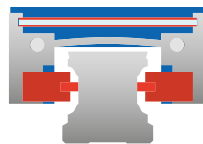

Clamping element vented

Engaged

The clamping force of the mechanically pre-stressed spring steel plates is transferred to the clamping/brake pads as holding force. The clamping element is clamped on the guide rail.

Slot dimensions between braking and clamping linings and linear guide rail

The internal dimension "I" between the linings of every LOCKED rail clamping is ground to an exact value.

This is always 0.01 to 0.03 mm greater than the upper limit J max. of the respective linear guide rail (see drawing), resulting from the manufacturer's directives.

The maximum holding force results at J max. and, in the most unfavorable case, holding force losses up to 30 % can occur (see table).

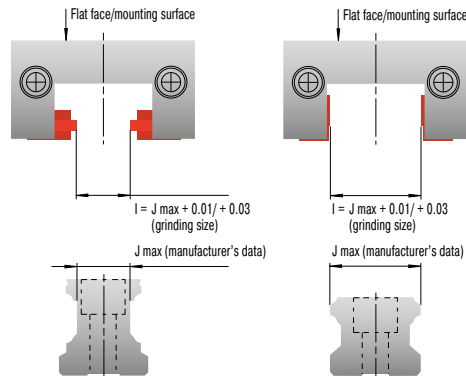

Air Gap Lining/Linear Guide Rail mm	Loss in Holding Force %
0.01	5
0.03	10
0.05	20
0.07	30

Different brake pads for PL/PLK and for SL/SLK

The process clamps and safety clamps are available completely identical in their structure.

They differ only in the clamping and brake pads material.



Clamping

Position Clamping

The types of the LOCKED series PL and PLK are designed for clamping directly on the linear guide. The clamping linings are produced from tool steel and offer 100 % clamping force, even in the case of lubricated rails.



Braking

Position Clamping and Emergency Stop Braking

With the typical SL, SLK, low-wear sinter graphite linings are employed. These enable both a position clamping, as well as emergency stop braking on the linear guide. In case of lubricated rails, a stopping force of 60 % of the nominal stopping force should be considered.

Rod Clamping

The modular solution for exact holding at certain positions

Safe and reliable stopping at a position or an operating state is an important part of many production processes. This task can be performed by the clamping elements from ACE. If clamping on a rod is required, the clamping elements of the PN and PRK families are the right choice.

Thanks to the patented spring steel plate system the rod clamps transfer clamping forces of up to 36,000 N directly to the (piston) rod.

The PN and PRK rod clamps can absorb both axial and rotary forces.

Function of clamping elements LOCKED PN and PRK

Consisting of a deck plate, one to four clamping units and a base plate, all rod clamps work with the reinforced spring steel plate system.

Through that, both axial and rotary forces can be absorbed.

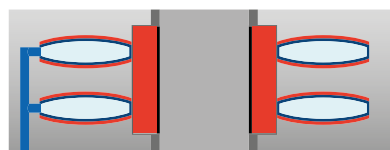

Clamping element is released

Released

The membrane filled with compressed air relaxes the spring steel plate system and releases the clamping sleeve.

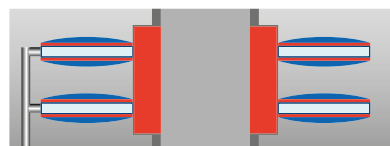

Clamping element is engaged

Engaged

The clamping force of the mechanically pre-stressed spring steel plates system is transferred as a holding force into the clamping sleeve. The rod or shaft is engaged.

Intelligent component system solution

By connecting up to four clamping units between the base and deck plates, it is possible to easily increase the clamping force.

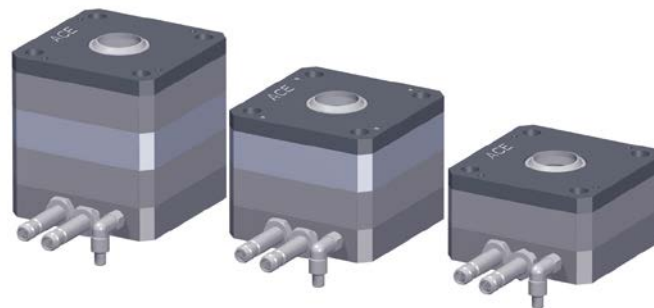

Modular construction

Component tolerances for LOCKED PN and PRK

Design-related, the addition of the individual component tolerances leads to an elastic axial tolerance allowance. This axial tolerance allowance can be up to 500 µm in the clamped status, according to implementation!

The axis/shaft/rod must be machined with at least h9-fit (or better) above h5. Deviations from the prescribed tolerance can lead to reduction of the stopping force, or functional failure.



Rod clamping

Rotational Clamping

The reliable protection against twisting

Reliable holding and securing against a rotation of a position are important elements in many production processes.

This task can be performed by means of the clamping elements of the Locked R family. The rotational clamps can, thanks to the patented spring steel plate system, transfer holding torques of up to 4,680 Nm to the shaft.

The spring accumulator can immediately clamp the axis during a power failure.

Function of clamping elements LOCKED R

The reinforced spring steel plate system transfers holding torques in the shortest possible time.



Clamping element is released

Released

The membrane filled with compressed air relaxes the spring steel plate system and releases the clamping ring. The shaft is free to move.



Clamping element is engaged

Engaged

The clamping force of the membrane/spring steel plates systems is transferred to the holding force of the clamping ring. The shaft is clamped.

Function of clamping elements LOCKED R-Z with additional air

If higher holding torques are required, the rotational clamps with an additional air function are used.

With the same size, significantly higher holding torques are achieved.



Increased clamping force with additional air

Engaged with additional air

By filling the outer membrane chamber with additional compressed air (4 or 6 bar), there is the possibility to increase the clamping force. The clamping element is engaged in this condition.

Clamping Elements



LOCKED PL

Page 280

Process Clamping for Rail Systems

High clamping power for all rail profiles

Tool machines, Transport systems, Feeder installations, Positioning tables



LOCKED PLK

Page 282

Process Clamping for Rail Systems, Compact

High clamping power for all compact design rail profiles

Tool machines, Transport systems, Feeder installations, Positioning tables



LOCKED SL

Page 284

Safety Clamping for Rail Systems

Combined clamping and braking

Tool machines, Transport systems, Feeder installations, Positioning tables



LOCKED SLK

Page 286

Safety Clamping for Rail Systems, Compact

Combined compact design clamping and braking

Tool machines, Transport systems, Feeder installations, Positioning tables



LOCKED LZ-P

Page 288

Rail Clamping for Z-Axes

Certified safety clamping

Z-axes, Vertical conveyor systems, Jacking applications



LOCKED PN

Page 290

Pneumatic Rod Clamping

Rod clamping with maximum clamping force

Jacking systems, Light presses, Punching/stamping machines, Stacking units



LOCKED PRK

Page 292

Pneumatic Rod Clamping, Compact

Rod clamping with maximum clamping force in a compact size

Jacking systems, Light presses, Punching/stamping machines, Stacking units



LOCKED R

Page 294

Pneumatic Rotational Clamping

Strong holding force on the shaft

Drive shafts, Torque motors, Conveyor systems

LOCKED PL

High clamping power for all rail profiles

Process Clamping for Rail Systems Holding forces 540 N to 10,000 N

Always on the safe side: LOCKED PL process clamping elements clamp directly onto the clear area of guide rails on linear modules with forces of up to 10,000 N. They are individually adjusted to the linear guide being used and are available for all rail sizes from 20 mm to 65 mm and profiles from all renowned manufacturers.

This product family achieves 100 % clamping force even on greased rails, due to the steel pads that are used. It offers optimum static clamping with up to 1 million cycles. These process clamping elements also impress with their low system costs in comparison with hydraulic and electric solutions.

The various LOCKED PL models from ACE are mainly used on machine tools and customised machines.

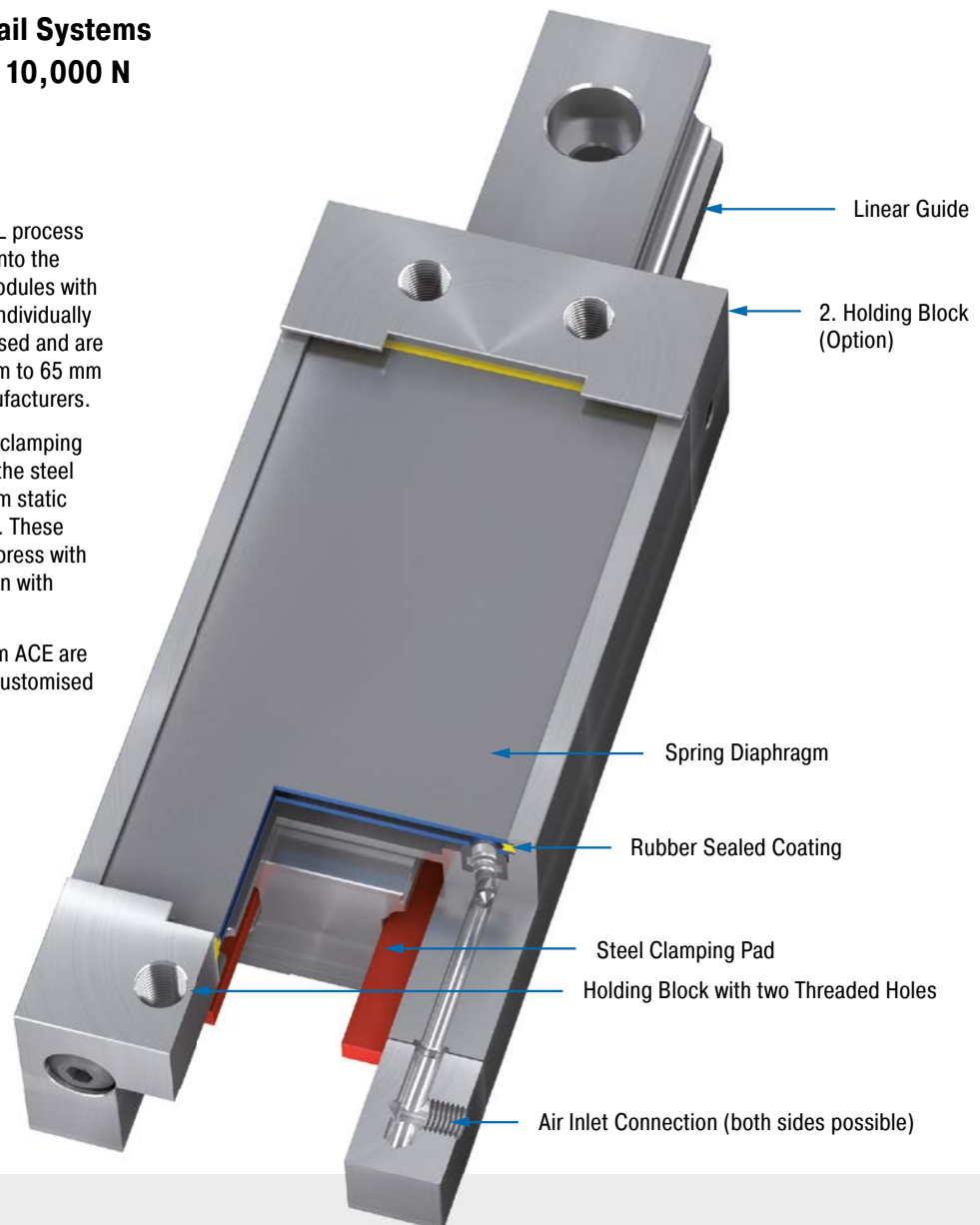

Technical Data

Holding forces: 540 N to 10,000 N

Rail sizes: 20 mm to 65 mm

Clamping cycles: 1,000,000

Mounting: In any position

Operating pressure: 4 bar (automotive) or 6 bar

Material: Outer body: Tool steel

Pneumatic medium: Dried, filtered air

Operating temperature range: 15 °C to 45 °C

Application field: Tool machines, Transport systems, Feeder installations, Positioning tables, Assembly stations

Note: If requested installation drawings of the respective types are provided.

On request: Special designs on request.

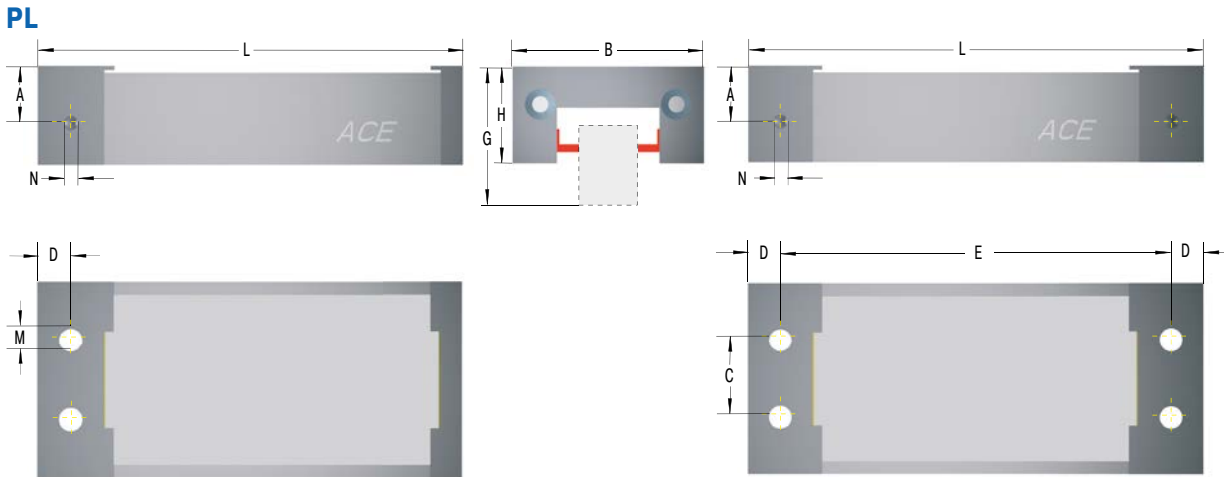

The calculation and selection of the most suitable clamping element should be carried out or be approved by ACE.

Complete details required when ordering

- Operating pressure: 4 bar or 6 bar
- Number of holding blocks
- Rail manufacturer, rail type, rail size
- Carriage type name
- Number of clamping cycles per hour

Ordering Example

Linear Process Clamping PL45-2-6B-X
 Rail Nominal Size 45 mm
 Number of Holding Blocks 2
 6B = 6 bar Type
 4B = 4 bar Type
 Series Number assigned by ACE

Performance and Dimensions

TYPES	Holding force N	Operating pressure bar	Low Carriage					High Carriage			M	N	Weight kg			
			B mm	C mm	D mm	E mm	L mm	A mm	G mm	H mm						
PL20-1-4B	540	4	43	12	6	-	97.5	13.5	30	19.5	-	-	-	M5	M5	0.32
PL20-1-6B	900	6	43	12	6	-	97.5	13.5	30	19.5	-	-	-	M5	M5	0.32
PL25-1-4B	780	4	47	16	6	-	117.5	15.5	36	25	19.5	40	29	M6	M5	0.50
PL25-1-6B	1,200	6	47	16	6	-	117.5	15.5	36	25	19.5	40	29	M6	M5	0.50
PL30-1-4B	1,100	4	59	18	10	-	126.5	17.0	42	29.5	20.0	45	32.5	M8	M5	0.90
PL30-1-6B	1,800	6	59	18	10	-	126.5	17.0	42	29.5	20.0	45	32.5	M8	M5	0.90
PL35-1-4B	1,800	4	69	22	10	-	156.5	22.5	48	35	29.5	55	42	M10	G1/8	1.26
PL35-1-6B	2,800	6	69	22	10	-	156.5	22.5	48	35	29.5	55	42	M10	G1/8	1.26
PL45-1-4B	2,400	4	80	28	10	-	176.5	26.5	60	42	36.5	70	52	M10	G1/8	2.30
PL45-1-6B	4,000	6	80	28	10	-	176.5	26.5	60	42	36.5	70	52	M10	G1/8	2.30
PL45-2-4B	2,400	4	80	28	10	171.2	191.5	26.5	60	42	36.5	70	52	M10	G1/8	2.30
PL45-2-6B	4,000	6	80	28	10	171.2	191.5	26.5	60	42	36.5	70	52	M10	G1/8	2.30
PL55-1-4B	3,600	4	98	34	12.5	-	202.5	28.0	70	49	38.0	80	59	M10	G1/8	3.90
PL55-1-6B	6,000	6	98	34	12.5	-	202.5	28.0	70	49	38.0	80	59	M10	G1/8	3.90
PL55-2-4B	3,600	4	98	34	12.5	196.2	221.5	28.0	70	49	38.0	80	59	M10	G1/8	4.10
PL55-2-6B	6,000	6	98	34	12.5	196.2	221.5	28.0	70	49	38.0	80	59	M10	G1/8	4.10
PL65-1-4B	6,000	4	120	44	15	-	259.5	38.0	90	64	48.0	100	74	M12	G1/8	5.00
PL65-1-6B	10,000	6	120	44	15	-	259.5	38.0	90	64	48.0	100	74	M12	G1/8	5.00
PL65-2-4B	6,000	4	120	44	15	251.5	281.5	38.0	90	64	48.0	100	74	M12	G1/8	5.20
PL65-2-6B	10,000	6	120	44	15	251.5	281.5	38.0	90	64	48.0	100	74	M12	G1/8	5.20

¹ The holding forces as shown in the capacity chart were determined on dry rails for roller systems (STAR, INA). Different holding forces may occur for other rails.

LOCKED PLK

High clamping power for all compact design rail profiles

Process Clamping for Rail Systems, Compact
Holding forces 300 N to 2,100 N

Small can clamp perfectly too: The LOCKED-Family PLK clamping elements are more compact than the Series PL components. They also clamp directly onto the respective linear guide, suit all standard rail sizes from 15 mm to 55 mm and profiles from the known suppliers and are extremely reliable and space-saving.

Thanks to the patented spring steel plate system, the LOCKED-Family PLK achieves clamping and holding forces of up to 2,100 N with the shortest reaction times when vented. LOCKED PLK achieve 100 % clamping force due to the steel pads that are used, even on greased rails. The clamping elements represent the maximum holding forces. Whether in the 4 or 6 bar version, they are good for up to 1 million cycles.

LOCKED PLK clamping elements from ACE are primarily used in mechanical engineering and customised machines.

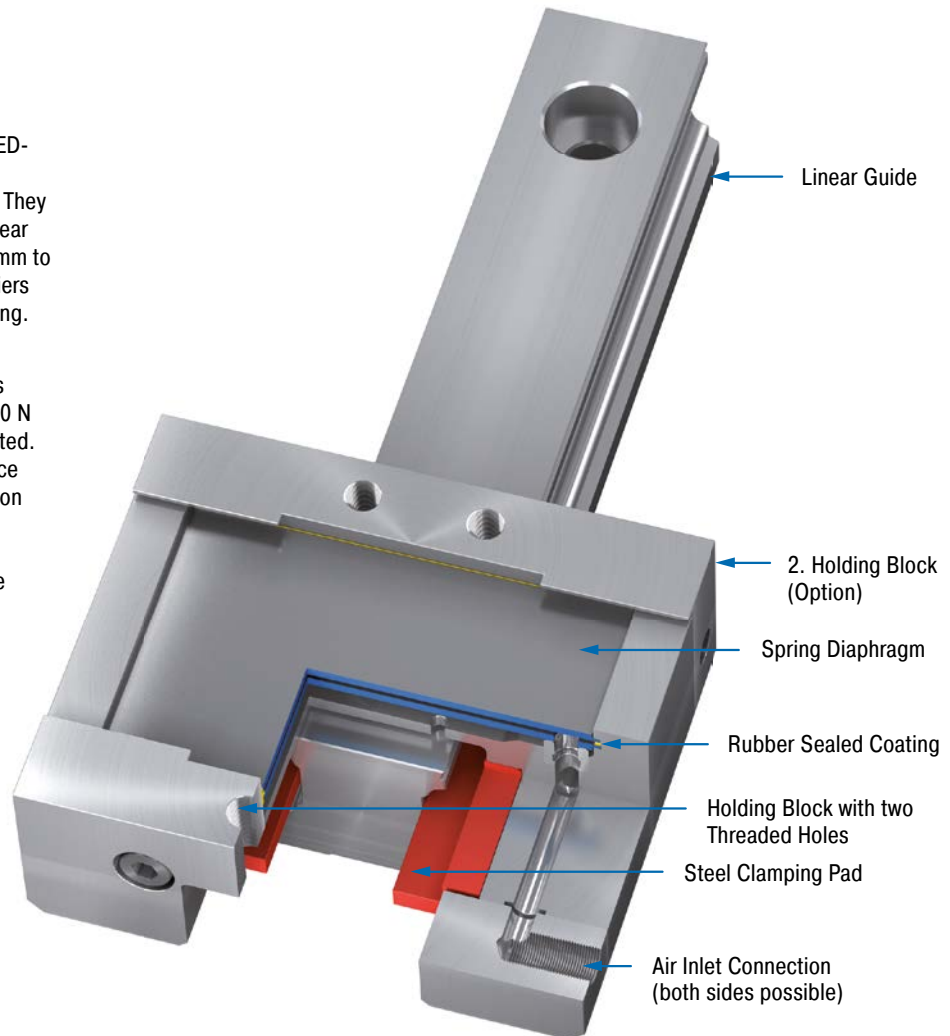

Technical Data

Holding forces: 300 N to 2,100 N

Rail sizes: 15 mm to 55 mm

Clamping cycles: 1,000,000

Mounting: In any position

Operating pressure: 4 bar (automotive) or 6 bar

Material: Outer body: Tool steel

Pneumatic medium: Dried, filtered air

Operating temperature range: 15 °C to 45 °C

Application field: Tool machines, Transport systems, Feeder installations, Positioning tables, Assembly stations

Note: If requested installation drawings of the respective types are provided.

On request: Special designs on request.

PLK

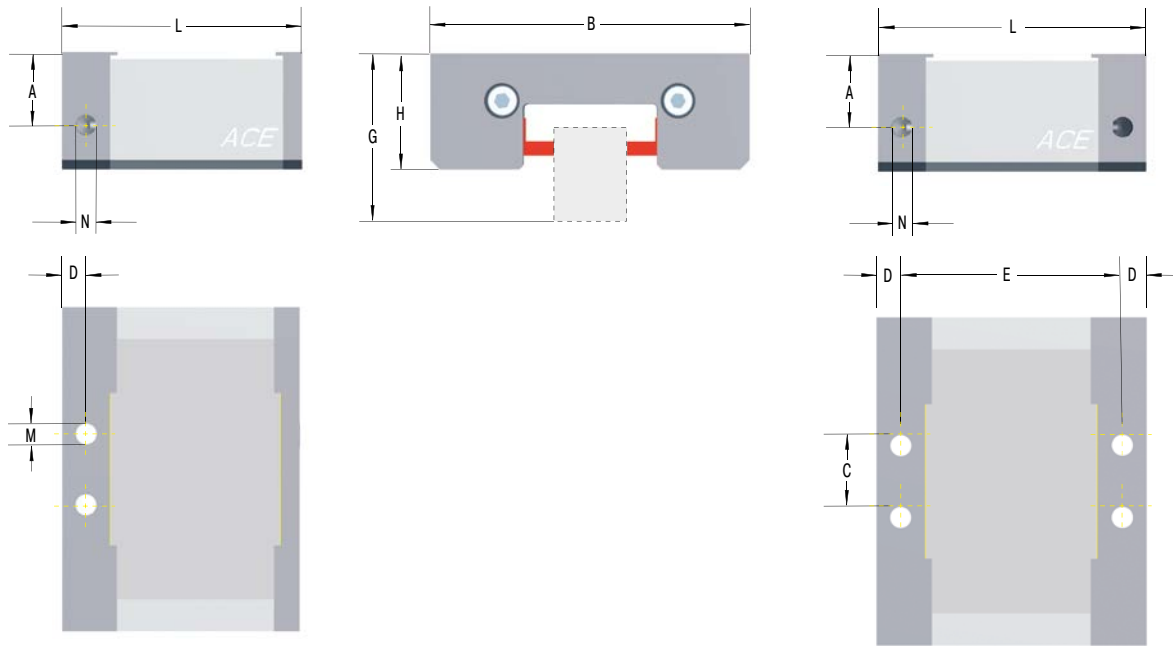

The calculation and selection of the most suitable clamping element should be carried out or be approved by ACE.

Complete details required when ordering

- Operating pressure: 4 bar or 6 bar
- Number of holding blocks
- Rail manufacturer, rail type, rail size
- Carriage type name
- Number of clamping cycles per hour

Ordering Example

Linear Process Clamping Compact _____
 Rail Nominal Size 55 mm _____
 Number of Holding Blocks 2 _____
 6B = 6 bar Type _____
 4B = 4 bar Type _____
 Series Number assigned by ACE _____

PLK55-2-6B-X

Performance and Dimensions

TYPES	Holding force N	Operating pressure bar	Low Carriage					High Carriage			M	N	Weight kg			
			B mm	C mm	D mm	E mm	L mm	A mm	G mm	H mm						
PLK15-1-4B	300	4	45	12	5	-	55.5	14.0	24	18	14.0	-	-	M5	M5	0.50
PLK15-1-6B	450	6	45	12	5	-	55.5	14.0	24	18	14.0	-	-	M5	M5	0.50
PLK20-1-4B	430	4	54	16	5	-	55.5	16.0	30	22	16.0	-	-	M6	M5	0.60
PLK20-1-6B	650	6	54	16	5	-	55.5	16.0	30	22	16.0	-	-	M6	M5	0.60
PLK25-1-4B	530	4	75	16	5	-	55.5	16.0	36	25.5	16.0	40	29.5	M6	M5	0.70
PLK25-1-6B	800	6	75	16	5	-	55.5	16.0	36	25.5	16.0	40	29.5	M6	M5	0.70
PLK30-1-4B	750	4	89	18	8.75	-	67	21.0	42	30	21.0	45	33	M8	M5	0.90
PLK30-1-6B	1,150	6	89	18	8.75	-	67	21.0	42	30	21.0	45	33	M8	M5	0.90
PLK35-1-4B	820	4	96	22	8.75	-	67	21.2	48	35	21.2	55	42	M10	G1/8	1.27
PLK35-1-6B	1,250	6	96	22	8.75	-	67	21.2	48	35	21.2	55	42	M10	G1/8	1.27
PLK45-1-4B	950	4	116	28	10	-	80	27.5	60	45	27.5	70	55	M10	G1/8	2.00
PLK45-1-6B	1,500	6	116	28	10	-	80	27.5	60	45	27.5	70	55	M10	G1/8	2.00
PLK45-2-4B	950	4	116	28	10	72	92	27.5	60	45	27.5	70	55	M10	G1/8	2.20
PLK45-2-6B	1,500	6	116	28	10	72	92	27.5	60	45	27.5	70	55	M10	G1/8	2.20
PLK55-1-4B	1,300	4	136	34	10	-	100	30.5	70	49	30.5	80	59	M10	G1/8	2.80
PLK55-1-6B	2,100	6	136	34	10	-	100	30.5	70	49	30.5	80	59	M10	G1/8	2.80
PLK55-2-4B	1,300	4	136	34	10	92	112	30.5	70	49	30.5	80	59	M10	G1/8	3.00
PLK55-2-6B	2,100	6	136	34	10	92	112	30.5	70	49	30.5	80	59	M10	G1/8	3.00

¹ The holding forces as shown in the capacity chart were determined on dry rails for roller systems (STAR, INA). Different holding forces may occur for other rails.

LOCKED SL

Combined clamping and braking

Safety Clamping for Rail Systems Holding forces 540 N to 10,000 N

Always on the safe side: The safety clamping elements LOCKED SL clamp and brake directly on the clear area of guide rails on linear modules with forces of up to 10,000 N. They are individually adjusted to the linear guide being used and are available for all rail sizes from 20 mm to 65 mm and profiles from all renowned manufacturers.

Special brake pads made of low wear sintered metal are used for the additional emergency stop braking functions in the safety clamping elements

LOCKED SL. The SL product family offers optimum static clamping with a service life up to 1 million cycles or up to 500 emergency braking operations. They also offer low system costs in comparison with hydraulic and electric solutions.

Anwender nutzen die LOCKED SL besonders im Maschinen- und Sondermaschinenbau.

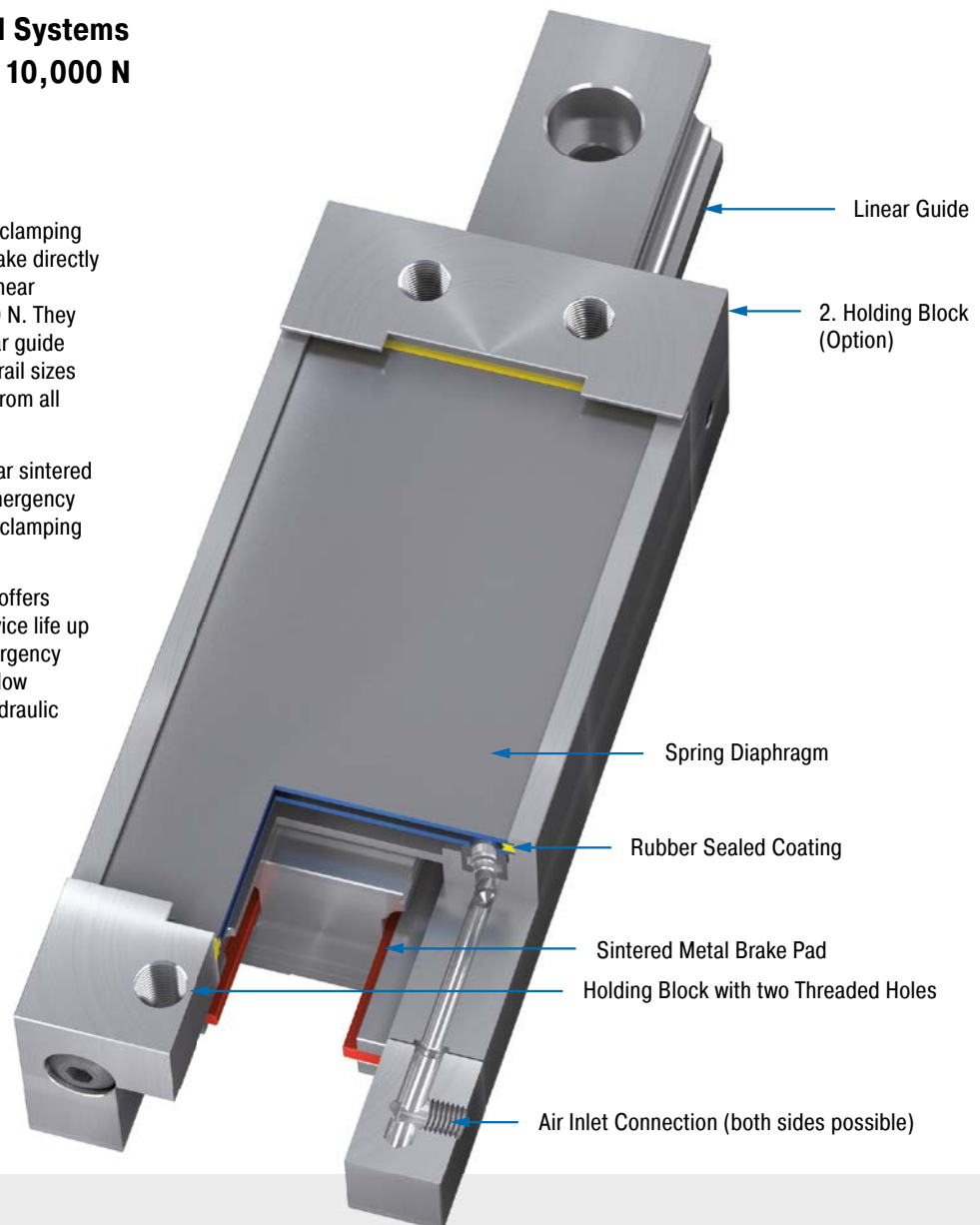

Technical Data

Holding forces: 540 N to 10,000 N

Rail sizes: 20 mm to 65 mm

Clamping cycles/emergency use: 500

Clamping cycles: 1,000,000

Mounting: In any position

Operating pressure: 4 bar (automotive) or 6 bar

Material: Outer body: Tool steel; Brake components: Sintered graphite

Pneumatic medium: Dried, filtered air

Operating temperature range: 15 °C to 45 °C

Application field: Tool machines, Transport systems, Feeder installations, Positioning tables, Assembly stations

Note: If requested installation drawings of the respective types are provided.

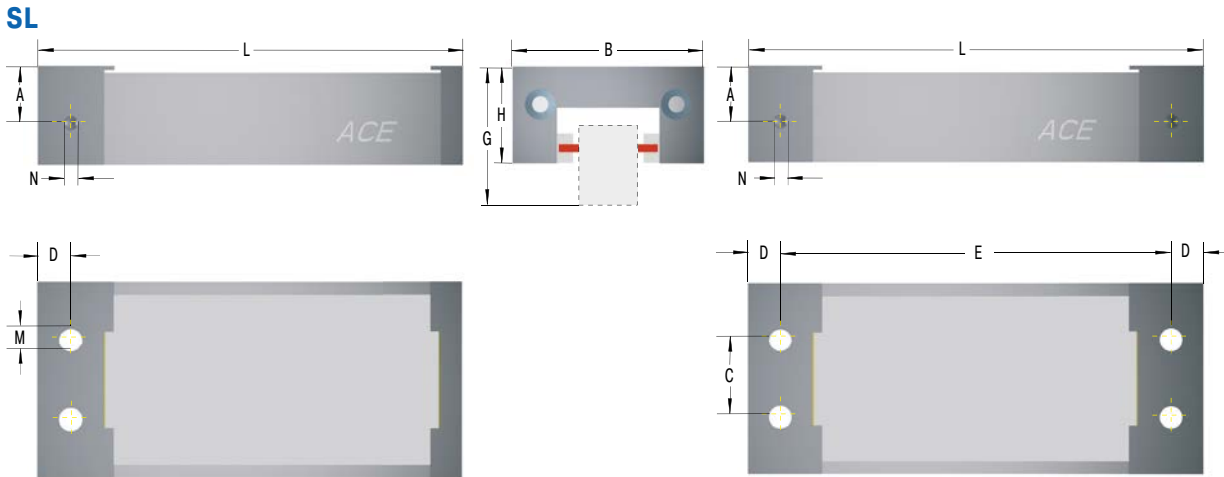

The calculation and selection of the most suitable clamping element should be carried out or be approved by ACE.

Complete details required when ordering

- Operating pressure: 4 bar or 6 bar
- Number of holding blocks
- Rail manufacturer, rail type, rail size
- Carriage type name
- Number of clamping cycles per hour

Ordering Example

Linear Safety Clamping **SL55-1-4B-X**
 Rail Nominal Size 55 mm
 Number of Holding Blocks 1
 4B = 4 bar Type
 6B = 6 bar Type
 Series Number assigned by ACE

Performance and Dimensions

TYPES	Holding force N	Operating pressure bar	B mm	C mm	D mm	E mm	L mm	Low Carriage			High Carriage			M	N	Weight kg
								A mm	G mm	H mm	A mm	G mm	H mm			
SL20-1-4B	540	4	43	12	6	-	97.5	13.5	30	19.5	-	-	-	M5	M5	0.32
SL20-1-6B	900	6	43	12	6	-	97.5	13.5	30	19.5	-	-	-	M5	M5	0.32
SL25-1-4B	780	4	47	16	6	-	117.5	15.5	36	25	19.5	40	29	M6	M5	0.50
SL25-1-6B	1,200	6	47	16	6	-	117.5	15.5	36	25	19.5	40	29	M6	M5	0.50
SL30-1-4B	1,100	4	59	18	10	-	126.5	17.0	42	29.5	20.0	45	32.5	M8	M5	0.90
SL30-1-6B	1,800	6	59	18	10	-	126.5	17.0	42	29.5	20.0	45	32.5	M8	M5	0.90
SL35-1-4B	1,800	4	69	22	10	-	156.5	22.5	48	35	29.5	55	42	M10	G1/8	1.26
SL35-1-6B	2,800	6	69	22	10	-	156.5	22.5	48	35	29.5	55	42	M10	G1/8	1.26
SL45-1-4B	2,400	4	80	28	10	-	176.5	26.5	60	42	36.5	70	52	M10	G1/8	2.30
SL45-1-6B	4,000	6	80	28	10	-	176.5	26.5	60	42	36.5	70	52	M10	G1/8	2.30
SL45-2-4B	2,400	4	80	28	10	171.2	191.5	26.5	60	42	36.5	70	52	M10	G1/8	2.30
SL45-2-6B	4,000	6	80	28	10	171.2	191.5	26.5	60	42	36.5	70	52	M10	G1/8	2.30
SL55-1-4B	3,600	4	98	34	12.5	-	202.5	28.0	70	49	38.0	80	59	M10	G1/8	3.90
SL55-1-6B	6,000	6	98	34	12.5	-	202.5	28.0	70	49	38.0	80	59	M10	G1/8	3.90
SL55-2-4B	3,600	4	98	34	12.5	196.2	221.5	28.0	70	49	38.0	80	59	M10	G1/8	3.90
SL55-2-6B	6,000	6	98	34	12.5	196.2	221.5	28.0	70	49	38.0	80	59	M10	G1/8	3.90
SL65-1-4B	6,000	4	120	44	15	-	259.5	38.0	90	64	48.0	100	74	M12	G1/8	5.00
SL65-1-6B	10,000	6	120	44	15	-	259.5	38.0	90	64	48.0	100	74	M12	G1/8	5.00
SL65-2-4B	6,000	4	120	44	15	251.2	281.5	38.0	90	64	48.0	100	74	M12	G1/8	5.20
SL65-2-6B	10,000	6	120	44	15	251.2	281.5	38.0	90	64	48.0	100	74	M12	G1/8	5.20

¹ The holding forces as shown in the capacity chart were determined on dry rails for roller systems (STAR, INA). Different holding forces may occur for other rails.

LOCKED SLK

Combined compact design clamping and braking

Safety Clamping for Rail Systems, Compact Holding forces 300 N to 2,100 N

Small can clamp perfectly too: The LOCKED-Family SLK clamping elements are more compact than the Series SL. They also clamp directly onto the respective linear guide, suit all standard rail sizes from 15 mm to 55 mm and profiles from the known suppliers and are extremely reliable and safe.

Thanks to the patented spring steel plate system, the product family SLK achieves clamping and holding forces of up to 2,100 N with the shortest reaction times when vented. Thanks to the sintered metal coatings and the clamping function in emergency stop (e.g. in case of a power failure), this range enables braking directly on the rail. All clamping elements offer the maximum holding and braking forces and achieve up to 1 million clamping cycles or up to a maximum of 500 emergency braking operations in the 4 and 6 bar version.

LOCKED SLK are used in mechanical engineering and customised mechanical engineering.

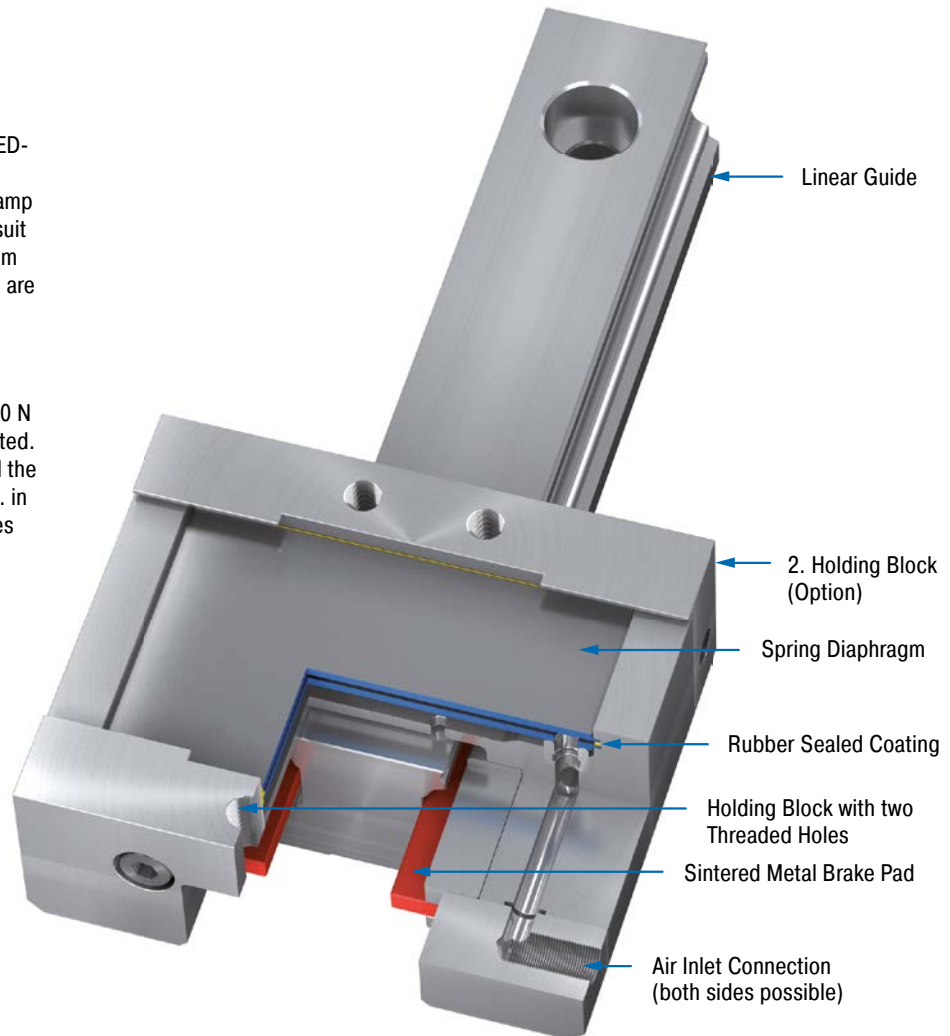

Technical Data

Holding forces: 300 N to 2,100 N

Rail sizes: 15 mm to 55 mm

Clamping cycles/emergency use: 500

Clamping cycles: 1,000,000

Mounting: In any position

Operating pressure: 4 bar (automotive) or 6 bar

Material: Outer body: Tool steel; Brake components: Sintered graphite

Pneumatic medium: Dried, filtered air

Operating temperature range: 15 °C to 45 °C

Application field: Tool machines, Transport systems, Feeder installations, Positioning tables, Assembly stations

Note: If requested installation drawings of the respective types are provided.

On request: Special designs on request.

SLK

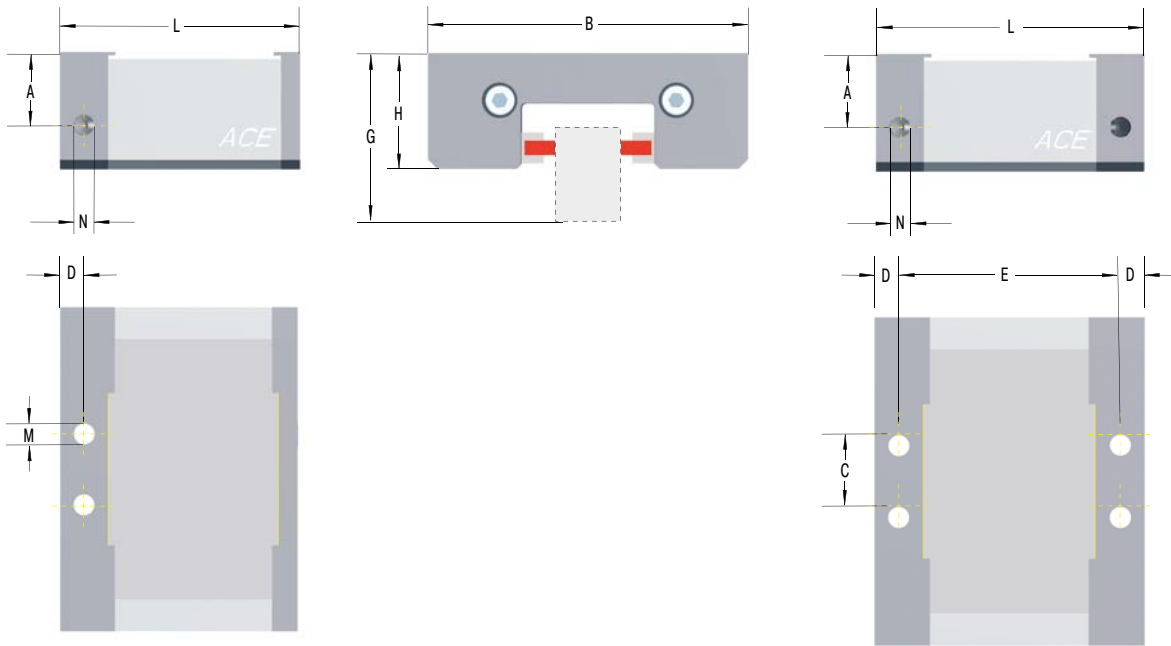

The calculation and selection of the most suitable clamping element should be carried out or be approved by ACE.

Complete details required when ordering

- Operating pressure: 4 bar or 6 bar
- Number of holding blocks
- Rail manufacturer, rail type, rail size
- Carriage type name
- Number of clamping cycles per hour

Ordering Example

Linear Safety Clamping Compact _____
 Rail Nominal Size 45 mm _____
 Number of Holding Blocks 1 _____
 4B = 4 bar Type _____
 6B = 6 bar Type _____
 Series Number assigned by ACE _____

SLK45-1-4B-X

Performance and Dimensions

TYPES	Holding force N	Operating pressure bar	Low Carriage					High Carriage			M	N	Weight kg			
			B mm	C mm	D mm	E mm	L mm	A mm	G mm	H mm						
SLK15-1-4B	300	4	45	12	5	-	55.5	14.0	24	18	14.0	-	-	M5	M5	0.50
SLK15-1-6B	450	6	45	12	5	-	55.5	14.0	24	18	14.0	-	-	M5	M5	0.50
SLK20-1-4B	430	4	54	16	5	-	55.5	16.0	30	22	16.0	-	-	M6	M5	0.60
SLK20-1-6B	650	6	54	16	5	-	55.5	16.0	30	22	16.0	-	-	M6	M5	0.60
SLK25-1-4B	530	4	75	16	5	-	55.5	16.0	36	25.5	16.0	40	29.5	M6	M5	0.70
SLK25-1-6B	800	6	75	16	5	-	55.5	16.0	36	25.5	16.0	40	29.5	M6	M5	0.70
SLK30-1-4B	750	4	89	18	8.75	-	67	21.0	42	30	21.0	45	33	M8	M5	0.90
SLK30-1-6B	1,150	6	89	18	8.75	-	67	21.0	42	30	21.0	45	33	M8	M5	0.90
SLK35-1-4B	820	4	96	22	8.75	-	67	21.2	48	35	21.2	55	42	M10	G1/8	1.27
SLK35-1-6B	1,250	6	96	22	8.75	-	67	21.2	48	35	21.2	55	42	M10	G1/8	1.27
SLK45-1-4B	950	4	116	28	10	-	80	27.5	60	45	27.5	70	55	M10	G1/8	2.00
SLK45-1-6B	1,500	6	116	28	10	-	80	27.5	60	45	27.5	70	55	M10	G1/8	2.00
SLK45-2-4B	950	4	116	28	10	72	92	27.5	60	45	27.5	70	55	M10	G1/8	2.20
SLK45-2-6B	1,500	6	116	28	10	72	92	27.5	60	45	27.5	70	55	M10	G1/8	2.20
SLK55-1-4B	1,300	4	136	34	10	-	100	30.5	70	49	30.5	80	59	M10	G1/8	2.80
SLK55-1-6B	2,100	6	136	34	10	-	100	30.5	70	49	30.5	80	59	M10	G1/8	2.80
SLK55-2-4B	1,300	4	136	34	10	92	112	30.5	70	49	30.5	80	59	M10	G1/8	3.00
SLK55-2-6B	2,100	6	136	34	10	92	112	30.5	70	49	30.5	80	59	M10	G1/8	3.00

¹ The holding forces as shown in the capacity chart were determined on dry rails for roller systems (STAR, INA). Different holding forces may occur for other rails.

LOCKED LZ-P

Certified safety clamping

Rail Clamping for Z-Axes

Holding forces 1,500 N to 2,500 N

Innovative and BG certified: The pneumatic clamping elements LOCKED LZ-P have been specially designed for safe, reliable clamping on the vertical or Z-axes. The wedge principle makes sure that the gravity loaded axis does not drop. The brake wedges are pushed on both sides against the flat parallel surfaces of the guide rail in case of a loss of pressure.

Initially developed for Bosch Rexroth rails in sizes 15 mm and 25 mm, a test certificate from the trade association was awarded after extensive tests on these clamping elements. Further certifications from other rail manufacturers and sizes are prepared and can be implemented within the shortest time. Users achieve holding forces of up to 2,500 N.

Pneumatic clamping elements LOCKED LZ-P are used in all sectors of modern mechanical engineering and customised machine tools.

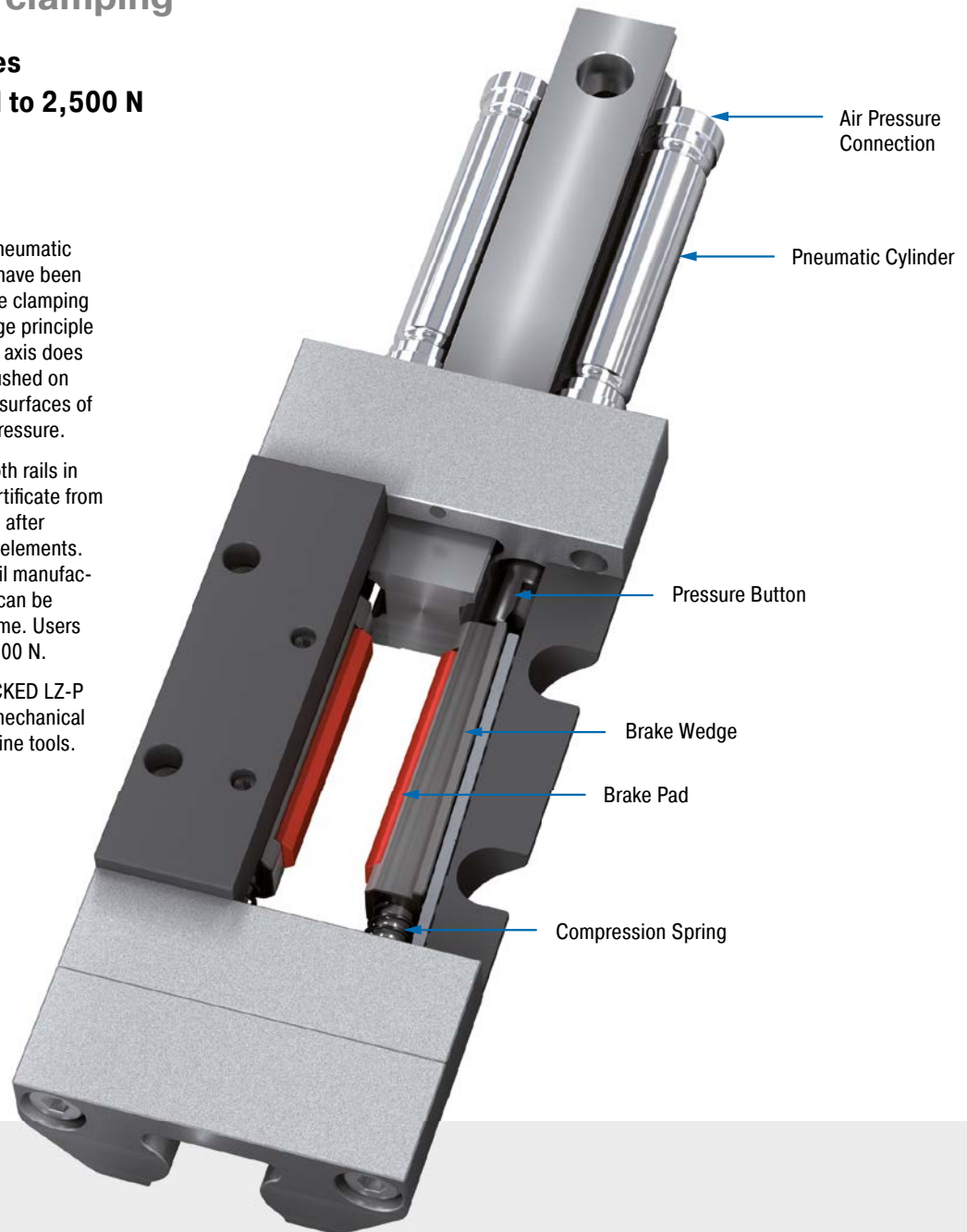

Technical Data

Holding forces: 1,500 N to 2,500 N

Rail sizes: 15 mm and 25 mm Bosch Rexroth

Clamping cycles: 1,000,000

Mounting: Vertical

Effective direction: Z-axes toward gravity

Operating pressure: 4.8 bar to 8 bar

Material: Outer body: Tool steel; Brake components: Steel

Pneumatic medium: Dried, filtered air

Operating temperature range: 0 °C to 60 °C

Application field: Z-axes, Vertical conveyor systems, Jacking applications

LZ-P

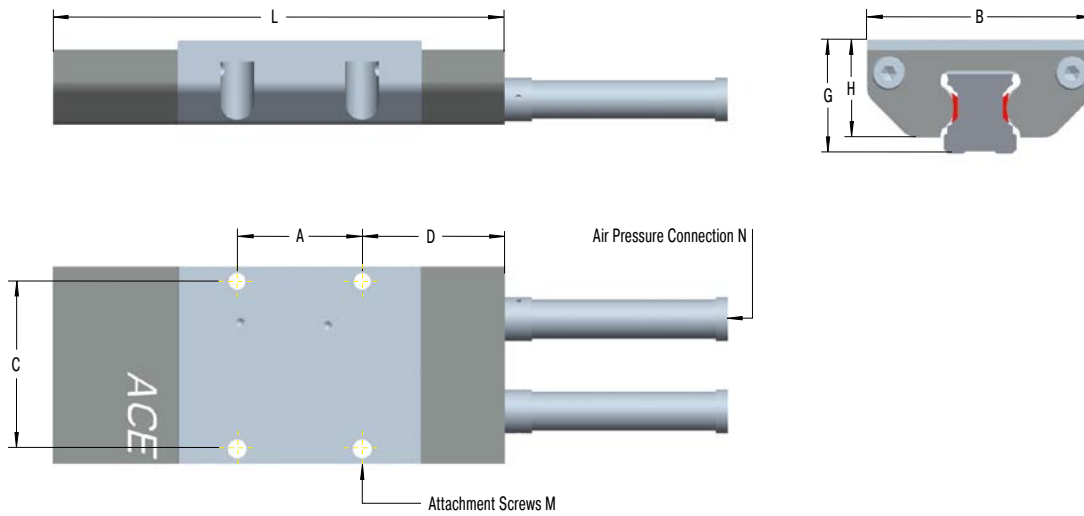

The calculation and selection of the most suitable clamping element should be carried out or be approved by ACE.

Ordering Example

Process Clamping Z-Axis _____ **LZ-P15-X**
 Rail Nominal Size 15 mm _____
 Series Number assigned by ACE _____

Performance and Dimensions

TYPES	Holding force N	A mm	B mm	C mm	D mm	G mm	H mm	L mm	M	N	Weight kg
LZ-P15-X	1,500	30	47	40	34	24	20	108.5	M4	M3	0.40
LZ-P25-X	2,500	30	70	56	70	36	30	170.0	M6	M5	1.30

LOCKED PN

Rod clamping with maximum clamping force

Pneumatic Rod Clamping

Holding forces 1,400 N to 36,000 N

Holding torques 15 Nm to 720 Nm

Immediate clamping in case of loss of pneumatics: Suitable for rods with diameters of 20 mm to 40 mm, the clamping elements LOCKED PN absorb the forces axially and rotationally. With holding forces of up to 36,000 N, they reach or exceed the levels of hydraulic clamps. The system costs are however lower.

Alongside clamping in both directions of motion, the LOCKED-PN also surprises with its compact design. They need less installation space and enable short rod lengths. Many users appreciate the modular system. It allows several segments to be stacked so that the necessary clamping force can be attained for every application.

The areas of application for the ACE product family LOCKED PN are mechanical engineering and machine tools.

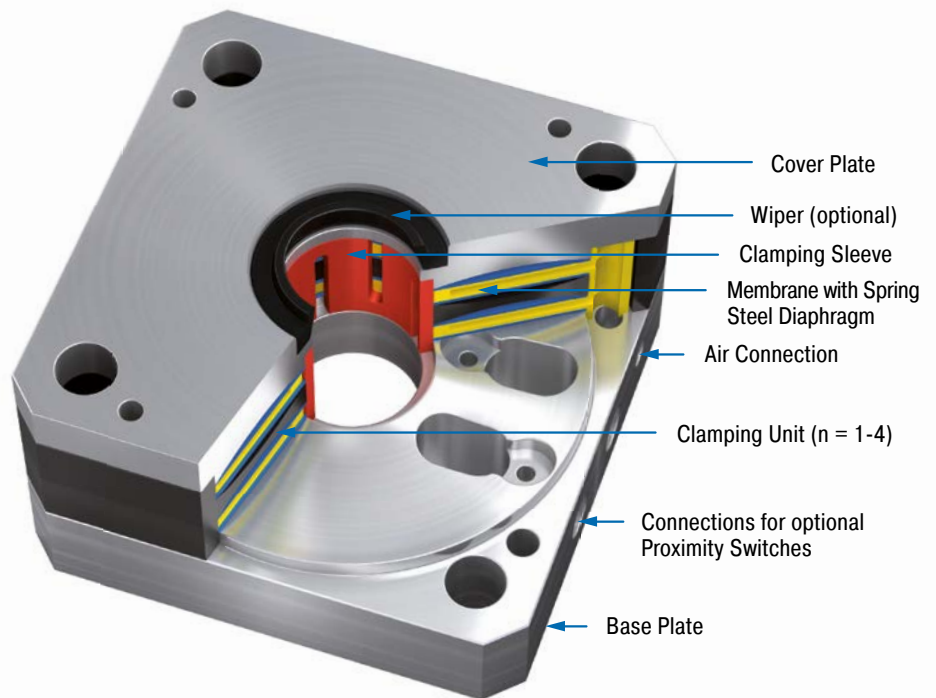

Technical Data

Holding torques: 15 Nm to 720 Nm

Holding forces: 1,400 N to 36,000 N

Rod diameter: Ø 20 mm to Ø 40 mm

Clamping cycles: 1,000,000

Mounting: In any position

Operating pressure: 4 bar (automotive) or 6 bar

Material: Outer body: Tool steel

Pneumatic medium: Dried, filtered air

Operating temperature range: 10 °C to 45 °C

Application field: Jacking systems, Light presses, Punching/stamping machines, Stacking units

Note: When mounting, use hardened piston rod.

On request: Special designs as for example special diameters and accessories available on request. Versions matching to ISO pneumatic cylinders including base plates coordinated to the dimensions of the flange sizes of standard cylinders according to ISO 15552 are also available.

PN

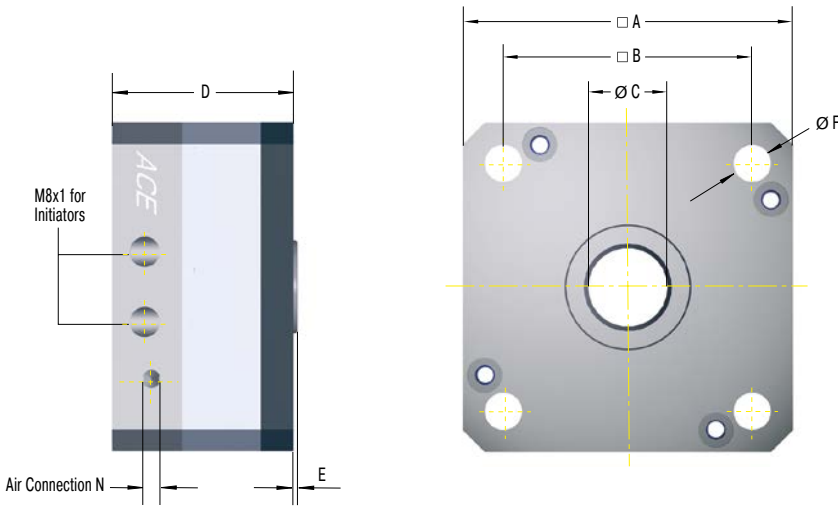

The calculation and selection of the most suitable clamping element should be carried out or be approved by ACE.

Complete details required when ordering

Operating pressure: 4 bar or 6 bar

Ordering Example

Rod Clamping Standard Model _____ **PN80-25-3-4B**
 ISO Cylinder Nominal Diameter 80 mm _____
 Rod Diameter 25 mm _____
 Number of Clamping Units 3 _____
 6B = 6 bar Type _____
 4B = 4 bar Type _____

Performance and Dimensions

TYPES	¹ Holding force N	Holding torque Nm	Operating pressure bar	A mm	B mm	C mm	D mm	E mm	F mm	N	Weight kg
PN63-20-1-4B	1,400	15	4	75	56.5	20	41.5	2.1	8.5	M5	0.70
PN63-20-1-6B	2,000	20	6	75	56.5	20	41.5	2.1	8.5	M5	0.70
PN63-20-2-4B	2,520	25	4	75	56.5	20	59.5	2.1	8.5	M5	1.13
PN63-20-2-6B	3,600	35	6	75	56.5	20	59.5	2.1	8.5	M5	1.13
PN63-20-3-4B	3,780	35	4	75	56.5	20	77.5	2.1	8.5	M5	1.56
PN63-20-3-6B	5,400	50	6	75	56.5	20	77.5	2.1	8.5	M5	1.56
PN80-25-1-4B	2,100	25	4	96	72	25	43.5	2.14	10.5	G1/8	1.30
PN80-25-1-6B	3,000	35	6	96	72	25	43.5	2.14	10.5	G1/8	1.30
PN80-25-2-4B	3,780	40	4	96	72	25	63.5	2.14	10.5	G1/8	2.20
PN80-25-2-6B	5,400	60	6	96	72	25	63.5	2.14	10.5	G1/8	2.20
PN80-25-3-4B	5,670	65	4	96	72	25	83.5	2.14	10.5	G1/8	3.10
PN80-25-3-6B	8,100	95	6	96	72	25	83.5	2.14	10.5	G1/8	3.10
PN125-40-1-4B	7,000	140	4	145	110	40	51.6	3	13	G1/8	3.65
PN125-40-1-6B	10,000	200	6	145	110	40	51.6	3	13	G1/8	3.65
PN125-40-2-4B	12,600	250	4	145	110	40	75.2	3	13	G1/8	5.85
PN125-40-2-6B	18,000	360	6	145	110	40	75.2	3	13	G1/8	5.85
PN125-40-3-4B	18,900	375	4	145	110	40	98.8	3	13	G1/8	8.05
PN125-40-3-6B	27,000	540	6	145	110	40	98.8	3	13	G1/8	8.05
PN125-40-4-4B	25,200	500	4	145	110	40	122.4	3	13	G1/8	10.25
PN125-40-4-6B	36,000	720	6	145	110	40	122.4	3	13	G1/8	10.25

¹ The listed holding forces are reached under optimum conditions. We recommend a safety factor of > 10 %. Please note that surface, material and cleanliness of the rod as well as wear and tear and the use of rod wipers lead to different holding forces. Test the clamping needed for series production or safety applications in its specific application environment and measure the actual values.

LOCKED PRK

Rod clamping with maximum clamping force in a compact size

Pneumatic Rod Clamping, Compact
Holding forces 700 N to 5,000 N
Holding torques 7 Nm to 100 Nm

Compact and safe: when space becomes restricted, the compact LOCKED PRK clamping elements come into their own. As pneumatic rod clamping with low heights of 28 mm to 34 mm, they provide clamping forces of up to 5,000 N.

Clamping is carried out by a diaphragm spring-plate system and is released when compressed air is applied. Clamping elements from the LOCKED PRK product family absorb the forces on rods with diameters between 20 mm and 40 mm both axially and rotationally. The function makes them suitable for use as static clamping without pressure, because the failure or drop of pneumatic pressure triggers immediate clamping. High clamping forces with low system costs compared with hydraulic and electric solutions make these clamping elements particularly interesting.

LOCKED PRK models are used in mechanical engineering and customised machine tools.

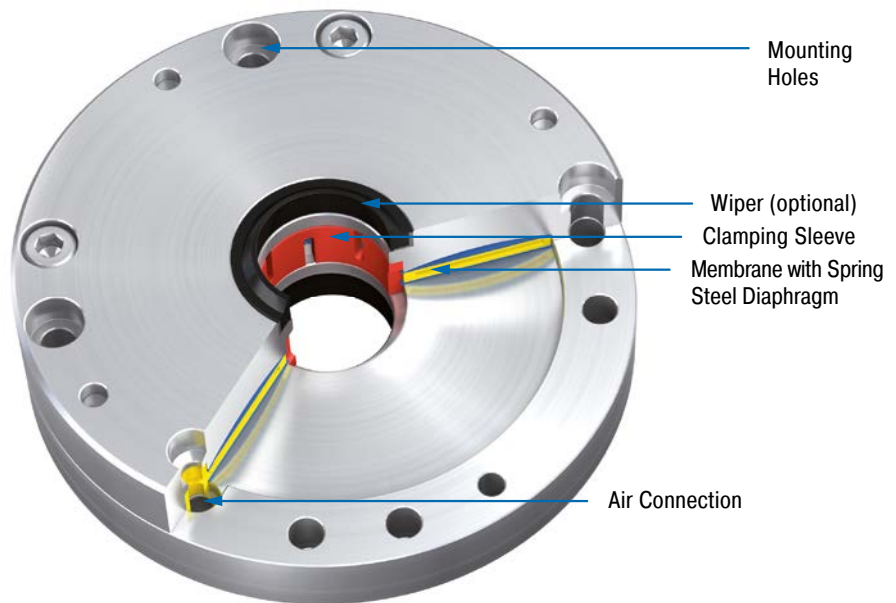

Technical Data

Holding torques: 7 Nm to 100 Nm

Holding forces: 700 N to 5,000 N

Rod diameter: Ø 20 mm to Ø 40 mm

Clamping cycles: 1,000,000

Mounting: In any position

Operating pressure: 4 bar (automotive) or 6 bar

Material: Outer body: Tool steel

Pneumatic medium: Dried, filtered air

Operating temperature range: 10 °C to 45 °C

Application field: Jacking systems, Light presses, Punching/stamping machines, Stacking units

Note: When mounting, use hardened piston rod.

On request: Special designs as for example special diameters and accessories available on request. Versions matching to ISO pneumatic cylinders including base plates coordinated to the dimensions of the flange sizes of standard cylinders according to ISO 15552 are also available.

PRK

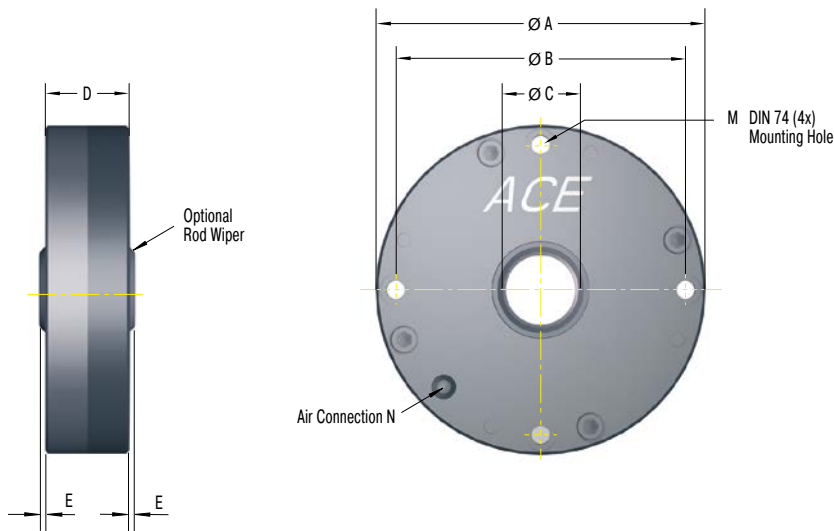

The calculation and selection of the most suitable clamping element should be carried out or be approved by ACE.

Complete details required when ordering

Operating pressure: 4 bar or 6 bar

Ordering Example

Rod Clamping Compact _____ **PRK80-25-6B**
 ISO Cylinder Nominal Diameter 80 mm _____
 Rod Diameter 25 mm _____
 6B = 6 bar Type _____
 4B = 4 bar Type _____

Performance and Dimensions

TYPES	¹ Holding force N	Holding torque Nm	Operating pressure bar	A mm	B mm	C mm	D mm	E mm	M	N	Weight kg
PRK63-20-4B	700	7	4	92	80	20	28	2.1	M5	G1/8	1.15
PRK63-20-6B	1,000	10	6	92	80	20	28	2.1	M5	G1/8	1.15
PRK80-25-4B	1,050	12	4	118	104	25	28.6	2.14	M6	G1/8	2.10
PRK80-25-6B	1,500	17	6	118	104	25	28.6	2.14	M6	G1/8	2.10
PRK125-40-4B	3,500	70	4	168	152	40	28.6	3	M6	G1/8	4.90
PRK125-40-6B	5,000	100	6	168	152	40	28.6	3	M6	G1/8	4.90

¹ The listed holding forces are reached under optimum conditions. We recommend a safety factor of > 10 %. Please note that surface, material and cleanliness of the rod as well as wear and tear and the use of rod wipers lead to different holding forces. Test the clamping needed for series production or safety applications in its specific application environment and measure the actual values.

LOCKED R

Strong holding force on the shaft

Pneumatic Rotational Clamping Holding torques 42 Nm to 4,680 Nm

Direct clamping on the shaft: Rotation motions are prevented by the ACE models LOCKED R. Their clamping elements are available for shaft diameters of 50 mm to 340 mm and ensure maximum holding forces.

The clamp is immediately applied by the diaphragm and spring-plate system when pressure is lost. Pneumatic quick-switch valves reduce the reaction times. The costs are low in comparison with hydraulic clamping systems. Their performance is, however, achieved or exceeded despite the compact and easy to assemble design. Special versions for YRT bearings as well as active clamping elements are additionally available. ACE recommends the use of the optional shaft flange as wear protection. The clamping force can be increased considerably by the use of the additional air function.

Models from the LOCKED R product family are used in mechanical engineering and customised machine tools.

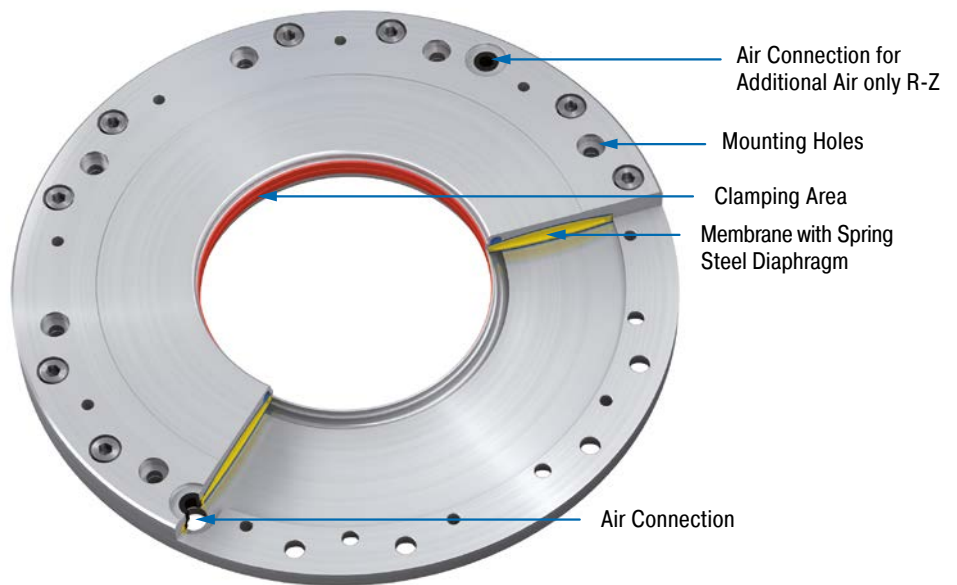

Technical Data

Holding torques: 42 Nm to 4,680 Nm

Shaft diameter: Ø 50 mm to Ø 340 mm

Clamping cycles: 1,000,000

Mounting: In any position

Operating pressure: 4 bar (automotive) or 6 bar

Material: Outer body: Hardened fine-grain structural steel, inner bore ground

Pneumatic medium: Dried, filtered air

Operating temperature range: 10 °C to 45 °C

Application field: Drive shafts, Torque motors, Conveyor systems

Note: If requested installation drawings of the respective types are provided.

On request: Special designs and customised solutions e.g. YRT bearing up to Ø 460 mm and shaft flange available on request.

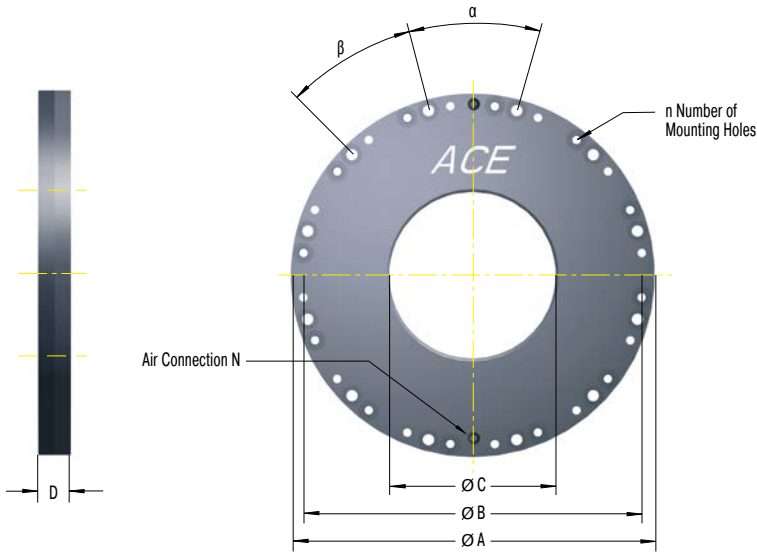
R

The calculation and selection of the most suitable clamping element should be carried out or be approved by ACE.

Complete details required when ordering

Operating pressure: 4 bar or 6 bar

Ordering Example

Rotational Clamping R80-6B
 Shaft Nominal Diameter 80 mm
 6B = 6 bar Type
 4B = 4 bar Type

Performance and Dimensions

TYPES	Holding torque Nm	Operating pressure bar	A mm	B mm	C opened mm	Shaft Diameter mm	D mm	N	n	α °	β °	Weight kg
R50-4B	42	4	145	134	50+0.03/+0.05	50-0.01/-0.025	15	M5	8	45	45	1.7
R50-6B	60	6	145	134	50+0.03/+0.05	50-0.01/-0.025	15	M5	8	45	45	1.7
R60-4B	59	4	155	144	60+0.03/+0.05	60-0.01/-0.025	15	M5	8	45	45	1.9
R60-6B	84	6	155	144	60+0.03/+0.05	60-0.01/-0.025	15	M5	8	45	45	1.9
R70-4B	80	4	165	154	70+0.03/+0.05	70-0.01/-0.025	15	M5	12	30	30	2.1
R70-6B	114	6	165	154	70+0.03/+0.05	70-0.01/-0.025	15	M5	12	30	30	2.1
R80-4B	105	4	175	164	80+0.03/+0.05	80-0.01/-0.025	15	M5	12	30	30	2.3
R80-6B	150	6	175	164	80+0.03/+0.05	80-0.01/-0.025	15	M5	12	30	30	2.3
R90-4B	132	4	185	174	90+0.03/+0.05	90-0.01/-0.025	15	M5	12	30	30	2.5
R90-6B	189	6	185	174	90+0.03/+0.05	90-0.01/-0.025	15	M5	12	30	30	2.5
R100-4B	168	4	228	210	100+0.04/+0.06	100-0.01/-0.025	16	G1/8	12	40	20	4.1
R100-6B	240	6	228	210	100+0.04/+0.06	100-0.01/-0.025	16	G1/8	12	40	20	4.1
R120-4B	235	4	248	230	120+0.04/+0.06	120-0.01/-0.025	16	G1/8	12	40	20	4.6
R120-6B	336	6	248	230	120+0.04/+0.06	120-0.01/-0.025	16	G1/8	12	40	20	4.6
R140-4B	319	4	268	250	140+0.04/+0.06	140-0.01/-0.025	16	G1/8	12	40	20	5.1
R140-6B	456	6	268	250	140+0.04/+0.06	140-0.01/-0.025	16	G1/8	12	40	20	5.1
R160-4B	420	4	288	270	160+0.04/+0.06	160-0.01/-0.025	16	G1/8	12	40	20	5.6
R160-6B	600	6	288	270	160+0.04/+0.06	160-0.01/-0.025	16	G1/8	12	40	20	5.6
R180-4B	525	4	308	290	180+0.04/+0.06	180-0.01/-0.025	20	G1/8	16	30	15	7.7
R180-6B	750	6	308	290	180+0.04/+0.06	180-0.01/-0.025	20	G1/8	16	30	15	7.7
R200-4B	651	4	328	310	200+0.05/+0.07	200-0.01/-0.03	20	G1/8	16	30	15	8.3
R200-6B	930	6	328	310	200+0.05/+0.07	200-0.01/-0.03	20	G1/8	16	30	15	8.3
R220-4B	777	4	348	330	220+0.05/+0.07	220-0.01/-0.03	20	G1/8	16	30	15	8.9
R220-6B	1,110	6	348	330	220+0.05/+0.07	220-0.01/-0.03	20	G1/8	16	30	15	8.9
R240-4B	945	4	368	350	240+0.05/+0.07	240-0.01/-0.03	20	G1/8	24	20	10	9.5
R240-6B	1,350	6	368	350	240+0.05/+0.07	240-0.01/-0.03	20	G1/8	24	20	10	9.5
R260-4B	1,092	4	388	370	260+0.05/+0.07	260-0.01/-0.03	22	G1/8	24	20	10	11.2
R260-6B	1,560	6	388	370	260+0.05/+0.07	260-0.01/-0.03	22	G1/8	24	20	10	11.2
R280-4B	1,260	4	408	390	280+0.05/+0.07	280-0.01/-0.03	22	G1/8	24	20	10	11.9
R280-6B	1,800	6	408	390	280+0.05/+0.07	280-0.01/-0.03	22	G1/8	24	20	10	11.9
R300-4B	1,470	4	428	410	300+0.05/+0.07	300-0.01/-0.03	22	G1/8	24	20	10	12.6
R300-6B	2,100	6	428	410	300+0.05/+0.07	300-0.01/-0.03	22	G1/8	24	20	10	12.6
R320-4B	1,638	4	448	430	320+0.05/+0.07	320-0.01/-0.03	22	G1/8	24	20	10	13.1
R320-6B	2,340	6	448	430	320+0.05/+0.07	320-0.01/-0.03	22	G1/8	24	20	10	13.1
R340-4B	1,806	4	468	450	340+0.05/+0.07	340-0.01/-0.03	22	G1/8	24	20	10	14.0
R340-6B	2,580	6	468	450	340+0.05/+0.07	340-0.01/-0.03	22	G1/8	24	20	10	14.0

R-Z

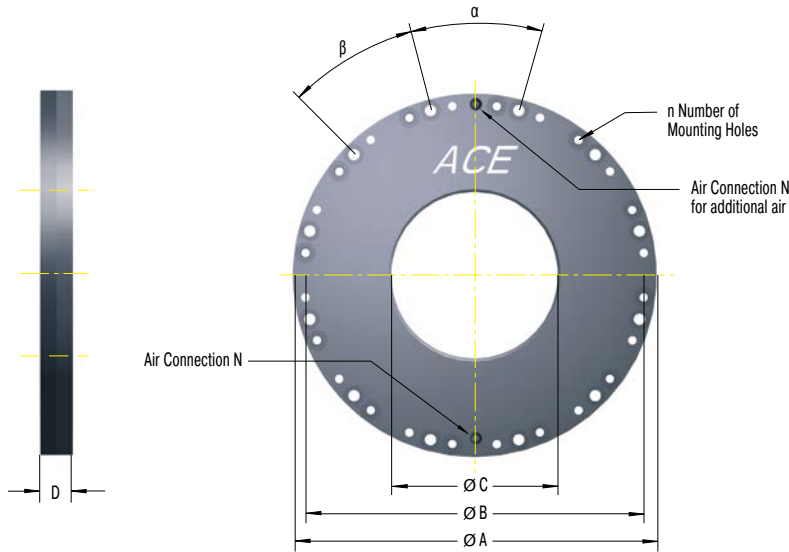

The calculation and selection of the most suitable clamping element should be carried out or be approved by ACE.

Complete details required when ordering

Operating pressure: 4 bar or 6 bar

Ordering Example

Rotational Clamping **R80-Z-6B**
 Shaft Nominal Diameter 80 mm
 Z = Increased Force with Additional Air
 6B = 6 bar Type
 4B = 4 bar Type

Performance and Dimensions

TYPES	Holding torque Nm	Operating pressure bar	A mm	B mm	C opened mm	Shaft Diameter mm	D mm	N	n	α	β	Weight kg
R50-Z-4B	76	4	145	134	50+0.03/+0.05	50-0.01/-0.025	15	M5	8	45	45	1.7
R50-Z-6B	108	6	145	134	50+0.03/+0.05	50-0.01/-0.025	15	M5	8	45	45	1.7
R60-Z-4B	107	4	155	144	60+0.03/+0.05	60-0.01/-0.025	15	M5	8	45	45	1.9
R60-Z-6B	153	6	155	144	60+0.03/+0.05	60-0.01/-0.025	15	M5	8	45	45	1.9
R70-Z-4B	147	4	165	154	70+0.03/+0.05	70-0.01/-0.025	15	M5	12	30	30	2.1
R70-Z-6B	210	6	165	154	70+0.03/+0.05	70-0.01/-0.025	15	M5	12	30	30	2.1
R80-Z-4B	189	4	175	164	80+0.03/+0.05	80-0.01/-0.025	15	M5	12	30	30	2.3
R80-Z-6B	270	6	175	164	80+0.03/+0.05	80-0.01/-0.025	15	M5	12	30	30	2.3
R90-Z-4B	239	4	185	174	90+0.03/+0.05	90-0.01/-0.025	15	M5	12	30	30	2.5
R90-Z-6B	342	6	185	174	90+0.03/+0.05	90-0.01/-0.025	15	M5	12	30	30	2.5
R100-Z-4B	294	4	228	210	100+0.04/+0.06	100-0.01/-0.025	16	G1/8	12	40	20	4.1
R100-Z-6B	420	6	228	210	100+0.04/+0.06	100-0.01/-0.025	16	G1/8	12	40	20	4.1
R120-Z-4B	420	4	248	230	120+0.04/+0.06	120-0.01/-0.025	16	G1/8	12	40	20	4.6
R120-Z-6B	600	6	248	230	120+0.04/+0.06	120-0.01/-0.025	16	G1/8	12	40	20	4.6
R140-Z-4B	588	4	268	250	140+0.04/+0.06	140-0.01/-0.025	16	G1/8	12	40	20	5.1
R140-Z-6B	840	6	268	250	140+0.04/+0.06	140-0.01/-0.025	16	G1/8	12	40	20	5.1
R160-Z-4B	756	4	288	270	160+0.04/+0.06	160-0.01/-0.025	16	G1/8	12	40	20	5.6
R160-Z-6B	1,080	6	288	270	160+0.04/+0.06	160-0.01/-0.025	16	G1/8	12	40	20	5.6
R180-Z-4B	966	4	308	290	180+0.04/+0.06	180-0.01/-0.025	20	G1/8	16	30	15	7.7
R180-Z-6B	1,380	6	308	290	180+0.04/+0.06	180-0.01/-0.025	20	G1/8	16	30	15	7.7
R200-Z-4B	1,176	4	328	310	200+0.05/+0.07	200-0.01/-0.03	20	G1/8	16	30	15	8.3
R200-Z-6B	1,680	6	328	310	200+0.05/+0.07	200-0.01/-0.03	20	G1/8	16	30	15	8.3
R220-Z-4B	1,428	4	348	330	220+0.05/+0.07	220-0.01/-0.03	20	G1/8	16	30	15	8.9
R220-Z-6B	2,040	6	348	330	220+0.05/+0.07	220-0.01/-0.03	20	G1/8	16	30	15	8.9
R240-Z-4B	1,680	4	368	350	240+0.05/+0.07	240-0.01/-0.03	20	G1/8	24	20	10	8.9
R240-Z-6B	2,400	6	368	350	240+0.05/+0.07	240-0.01/-0.03	20	G1/8	24	20	10	8.9
R260-Z-4B	1,974	4	388	370	260+0.05/+0.07	260-0.01/-0.03	22	G1/8	24	20	10	11.2
R260-Z-6B	2,820	6	388	370	260+0.05/+0.07	260-0.01/-0.03	22	G1/8	24	20	10	11.2
R280-Z-4B	2,268	4	408	390	280+0.05/+0.07	280-0.01/-0.03	22	G1/8	24	20	10	11.9
R280-Z-6B	3,240	6	408	390	280+0.05/+0.07	280-0.01/-0.03	22	G1/8	24	20	10	11.9
R300-Z-4B	2,604	4	428	410	300+0.05/+0.07	300-0.01/-0.03	22	G1/8	24	20	10	12.6
R300-Z-6B	3,720	6	428	410	300+0.05/+0.07	300-0.01/-0.03	22	G1/8	24	20	10	12.6
R320-Z-4B	2,940	4	448	430	320+0.05/+0.07	320-0.01/-0.03	22	G1/8	24	20	10	13.1
R320-Z-6B	4,200	6	448	430	320+0.05/+0.07	320-0.01/-0.03	22	G1/8	24	20	10	13.1
R340-Z-4B	3,276	4	468	450	340+0.05/+0.07	340-0.01/-0.03	22	G1/8	24	20	10	14.0
R340-Z-6B	4,680	6	468	450	340+0.05/+0.07	340-0.01/-0.03	22	G1/8	24	20	10	14.0

Issue 07.2017 – Specifications subject to change

Application Examples

SL Special LOCKED SL elements for emergency stops

In order to secure the processing position of a special lathe in both the horizontal and the vertical axis, ACE LOCKED elements of the type SL35-1-6B are installed. They have the further advantage of preventing slippage through the vertical axis in the case of a malfunction. The products used in the SL-series not only have the correct track width and offer very high process clamping forces of up to 10,000 N, but can also apply the same force as an emergency-stop braking function. This is due to the specially integrated brake linings made of low-wear sintered metal.



ACE clamping and safety elements maintain a rock-solid hold on the axes in special lathes and secure the predetermined positions both horizontally and vertically
RASOMA Werkzeugmaschinen GmbH, 04720 Döbeln, Germany

SLK Secure rail clamping

ACE clamping elements secure machines in the tyre industry. The goods accumulator/compensator of a material dispenser carries meandering, coiled, highly tear resistant material strips, which are fed at high speed to a tyre-manufacturing machine. To prevent damaging the machine, innovative type SLK25-1-6B clamping elements are employed.



Secure material accumulator

PN
Clamping elements as a variable stop

ACE clamping elements are inserted, as a variable stop, during a joining process for the production of drilling tools. They meet the requirements for a precise positioning of the workpiece head and an adaptation of the length tolerance of up to 3 mm, ideally. ACE was awarded the contract because the clamping element is attached on a bar and its PN LOCKED series is specifically designed for this purpose. For clamping on linear guides, rails, axles and shafts, ACE offers a great range of high-performance models.

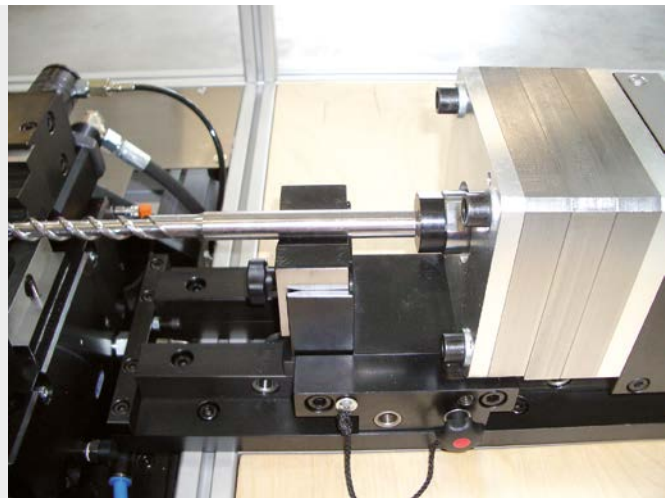

ACE clamping elements assist in the production of drilling tools: the LOCKED-P system clamps and at the same time absorbs the opposing forces of the joining process without difficulty
GRAF automation GmbH, 88214 Ravensburg, Germany

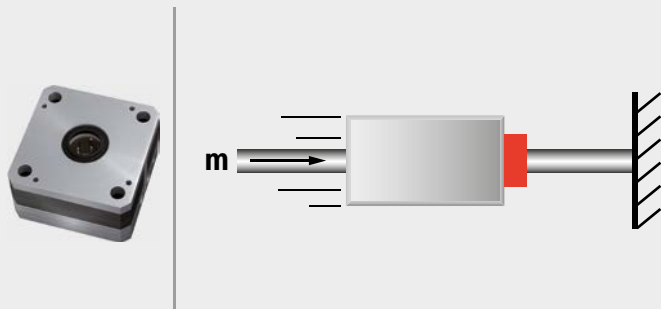

PN
Secure rod clamping

Pneumatic rod clamping allows hydraulic presses to be used for any application. With the help of hydraulic presses, cut ceramic parts are manufactured during the week. So that the rods of the upper and lower stamping plate do not sag when the press is at a standstill over the weekend or during holidays and therefore have to be setup again on the next working day, PN80-25-2-6B type rod clamps are used.

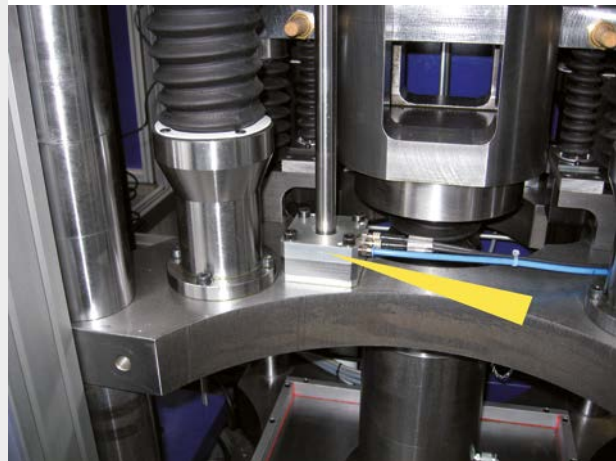

Pneumatic rod clamping allows hydraulic presses to be used for any application
KOMAGE Gellner Maschinenfabrik KG, 54427 Kell am See, Germany



ACE Expertise Compact

Lectures, training courses and a new demonstration vehicle

Free and Convenient in your Premises

Whether in the training vehicle or through lectures: we have a lot to tell. Images, tests and concrete products at your location convey information much more quickly and plausibly than speech or written materials.

In our free specialised lectures we clearly demonstrate the function and mode of operation of the damping elements. Fast, compact and completely tailored to suit you. ACE presentations include video material, a lot of application images, drop tester and a pneumatic demonstration unit along with original "live" products.

We illuminate kinetic energies and the impact on production processes, design and mode of operation of shock absorbers, we compare techniques, calculate, perform tests and show typical applications.

Even more Compact: Training in the ACE Demonstration Vehicle

In 60 minutes, everything about automation control, motion control, vibration control and ACE safety products. Right at your premises on the parking lot.

Learn how you can increase your production, go easy on your machines, reduce noise and vibrations, simplify designs and save costs.

Ideal for smaller groups of about 8 people.



Fax Request

Our free and fast service

Do you need the new main catalogue? Are you interested in ACE lectures and presentations? Or a training course in the ACE demonstration vehicle with field representatives of your choice?

We offer compact, tailored presentation packages. These illustrate the function and mode of operation of the ACE products – quickly and easily. At our place or yours!

Please also use our contact form at www.ace-ace.com

Yes. We are interested in

- the new ACE catalogue
- a training in the demonstration vehicle
- product presentations in our premises
- a lecture at our site
- technical assistance at our site

Topic

- Automation Control
- Motion Control
- Vibration Control
- Safety Products

Your contact information

Company	
Name	
Function	
Department	
Address	
ZIP Code / City	
Telephone	
Fax	
E-Mail	
Internet	

Please copy, complete and fax to +49 (0)2173 - 9226-89

in Countries without ACE Facility

**ARGENTINA**

CAMOZZI NEUMATICA S.A.
Prof. Dr. Pedro Chutro 3048
1437 Buenos Aires, Argentina
T +54 11 49110816
F +54 11 49124191
www.camozzi.com.ar

**AUSTRIA**

ACE STOSSDÄMPFER GMBH
Albert-Einstein-Straße 15, 40764 Langenfeld, Germany
T +49 2173-9226-4000
F +49 2173-9226-29
www.ace-ace.de
(distributors on request)

**BELARUS**

BIBUS (BY) COOO
8th Per. Ilyicha 13a, office 2.1
246013 Gomel, Belarus
T +375 232 29 31 39
F +375 232 39 59 02
www.bibus.by
(not distributor for gas springs and HB dampers)

Gas spring & HB damper specialists:

TECHVITASBEL LLC
F. Skaryny str. 15B-3
220114 Minsk, Belarus
T +375 17 396 63 83
F +375 17 396 63 82
www.techvitas.by
(not distributor for shock absorbers, TUBUS, SLAB)

**BELGIUM**

ACE STOSSDÄMPFER GMBH
Albert-Einstein-Straße 15, 40764 Langenfeld, Germany
T +32 11-960736
F +32 11-960737
www.ace-ace.com
(distributors on request)

**BOSNIA AND HERZEGOVINA**

BIBUS DOO
Karadordeva, 76311 Dvorovi – Bijeljina
Bosnia and Herzegovina
T +387 55 423 444
F +387 55 423 444
www.bibus.ba
(not distributor for gas springs and HB dampers)

For gas springs & HB dampers:

ACE STOSSDÄMPFER GMBH
Albert-Einstein-Straße 15, 40764 Langenfeld, Germany
T +49 2173-9226-4100
F +49 2173-9226-89
www.ace-ace.com

**BRAZIL**

OBR EQUIPAMENTOS
INDUSTRIAIS LTDA.
Rua Florianópolis, 431, Mooca-São Paulo – SP.
CEP 03185-050, Brazil
T +55 11-2067 3698 / 0800704 3698
www.obr.com.br

**BULGARIA**

BIBUS BULGARIA LTD.
Tzvetan Lazarov Blv. 2, floor 2, 1574 Sofia, Bulgaria
T +359 2 971 98 08
F +359 2 927 32 64
www.bibus.bg
(not distributor for gas springs and HB dampers)

For gas springs & HB dampers:

ACE STOSSDÄMPFER GMBH
Albert-Einstein-Straße 15, 40764 Langenfeld, Germany
T +49 2173-9226-4100
F +49 2173-9226-89
www.ace-ace.com

**CHILE**

TAYLOR AUTOMATIZACION S.A.
Santiago De Urióna 1854, Quinta Normal
8500000 - Santiago, Chile
T +56 2 2555 1516
F +56 2 2544 1965
www.taylorsa.cl

**CROATIA**

BIBUS ZAGREB D.O.O.
Anina 91, 10000 Zagreb, Croatia
T +385 1 3818 004
F +385 1 3818 005
www.bibus.hr
(not distributor for gas springs and HB dampers)

For gas springs & HB dampers:

ACE STOSSDÄMPFER GMBH
Albert-Einstein-Straße 15, 40764 Langenfeld, Germany
T +49 2173-9226-4100
F +49 2173-9226-89
www.ace-ace.com

**CZECH REPUBLIC**

BIBUS S.R.O.
Videnska 125, 639 27 Brno, Czech Republic
T +420 547 125 300
F +420 547 125 310
www.bibus.cz
(not distributor for gas springs and HB dampers)

Gas spring & HB damper specialists:

MN-SYSTEMS, S.R.O.
Na Honech I/5538, 760 05 Zlín, Czech Republic
T +420 734 200 172
F +420 246 013 937
www.mnsystems.cz

**DENMARK**

AVN TEKNIK A/S
Dalager 1, 2605 Broendby, Denmark
T +45 70 20 04 11
F +45 43 24 55 00
www.avn.dk

**ESTONIA**

TECHVITAS OÜ
Peterburi tee 81-510, Tallinn 11415, Estonia
T +372 5670 0702
www.techvitas.ee

**FINLAND**

NESTEPAINNE OY
Makituvantie 11, 01510 Vantaa, Finland
T +358 20 765 165
F +358 20 765 7666
www.nestepaine.fi

MOVETEC OY

Hannuksentie 1, 02270 Espoo, Finland
T +358 9 5259 230
F +358 9 5259 2333
www.movetec.fi

**FRANCE**

BIBUS FRANCE
ZA du Chapotin, 233 rue des Frères Voisin
69970 Chaponnay, France
T +33 4 78 96 80 00
F +33 4 78 96 80 01
www.bibusfrance.fr
(not distributor for gas springs and HB dampers)

For gas springs & HB dampers:

ACE STOSSDÄMPFER GMBH
Albert-Einstein-Straße 15, 40764 Langenfeld, Germany
T +49 2173-9226-4100
F +49 2173-9226-89
www.ace-ace.com

**GREECE**

PNEUMATEC INDUSTRIAL
AUTOMATION SYSTEMS
91 Spirou Patsi Street, Athens 11855, Greece
T +302 1 03412101 / 3413930
F +302 1 03413930

**HUNGARY**

BIBUS KFT.
Almáskert út 9, 2220 Vecsés, Hungary
T +36 29 557 763
F +36 29 557 777
www.bibus.hu
(not distributor for gas springs and HB dampers)

Gas spring & HB damper specialists:

DUNA CONSULTING KFT.
Gábor Áron u. 18, 2013 Pomáz, Hungary
T +36 1 433 4700, +36-30 26 36 576
F +36 1 264 8900
www.acegazrugo.hu

**INDIA**

SHREEJI MARKETING CORPORATION
2& 3, 1st Floor, Pride Plaza, Mumbai-Pune Road
Pimpri, Pune - 411018, India
T +91 20 2742 0897
F +91 20 2742 0997
www.shreejimt.com

**IRELAND**

IRISH PNEUMATIC SERVICES LTD.
5A M7 Business Park
Newhall, Naas, Co. Kildare, Ireland
T +353 45-872590
F +353 45-872595
www.irishpneumaticservices.com

**ISRAEL**

ILAN & GAVISH AUTOMATION SERVICE LTD.
26, Shenkar Street, Qiryat-arie 49513
PO Box 10118, 49001 Petah-Tiqva, Israel
T +972 39 22 18 24
F +972 39 24 07 61
www.ilan-gavish.co.il

**ITALY**

R.T.I. S.R.L.
Via Chambery 93/107V, 10142 Torino, Italy
T +39 011-70 00 53 / 70 02 32
F +39 011-70 01 41
www.rti-to.it

**JORDAN**

ATAFAWOK TRADING EST.
PO Box 921797, Amman 11192, Jordan
T +962 64 02 38 73
F +962 65 92 63 25

**LATVIA**

TECHVITAS SIA
38 Daugavas Street, Marupe
2167 Marupes nov., Latvia
T +371 27 530 003
F +371 29 847 378
www.techvitas.lv

LITHUANIA
TECHVITAS UAB

Dubysos g. 66A, 94107 Klaipeda, Lithuania
T +370 46 355 494
F +370 46 355 493
www.techvitas.lt

LUXEMBOURG
ACE STOSSDÄMPFER GMBH

Albert-Einstein-Straße 15, 40764 Langenfeld, Germany
T +32 11-960736
F +32 11-960737
www.ace-ace.com
(distributors on request)

NETHERLANDS
ACE STOSSDÄMPFER GMBH

Albert-Einstein-Straße 15, 40764 Langenfeld, Germany
T +31 165-714455
F +31 165-714456
www.ace-ace.com
(distributors on request)

NORWAY
ACE STOSSDÄMPFER GMBH

Albert-Einstein-Straße 15, 40764 Langenfeld, Germany
T +49 2173-9226-4100
F +49 2173-9226-89
www.ace-ace.com

HYDNET AB
Turebergsvagen 5, 191 47 Sollentuna, Sweden
T +46 8 59 470 470
F +46 8 59 470 479
www.hydnet.se

PAKISTAN
JJ HYDRAULIC PNEUMATIC

SYSTEMS (PVT) LTD.
41 # Old Ralli Building, Talpur Road,
Off, I I Chundrigar Road, Karachi – 74000, Pakistan
Dir no. 0092 0333 2229606
T +92 21 32426486 / 32426516
F +92 21 32416807

POLAND
BIBUS MENOS SP. Z.O.O.

ul. Spadochroniarzy 18, 80-298 Gdańsk, Poland
T +48 58 660 95 70
F +48 58 661 71 32
www.bibusmenos.pl
(not distributor for gas springs and HB dampers)

Gas spring & HB damper specialists:
F.H.U. ELMATIC S.C.
ul. Marii Skłodowskiej - Curie 73 A
87-100 Toruń, Poland
T / F +48 56 659 16 81
T +48 56 659 15 49, +48-56 653 98 10
www.elmatic.com.pl

PORTUGAL
AIRCONTROL INDUSTRIAL S.L.

Alameda Fernao Lopes 31A, Torre 2 - Miraflores
1495-136 Alges (Lisboa), Portugal
T +351 21 410 13 57
F +351 21 410 56 08
www.aircontrol.es

BIBUS PORTUGAL LDA
Centro Empresarial AAA, Rua Ponte da Pedra, 240 – C4
4470-108 Gueifães - Maia, Portugal
T +351 22 906 50 50
F +351 22 906 50 53
www.bibus.pt
(not distributor for gas springs and HB dampers)

ROMANIA
BIBUS SES S.R.L.

134/1 Calea Lugojului, 307200 Ghiroda, Timis, Romania
T +40 356 446 500
F +40 356 446 660
www.bibus.ro
(not distributor for gas springs and HB dampers)

Gas spring & HB damper specialists:
D.C. COMPANY S.R.L.
Dragos Voda nr. 43, 300351 Timisoara, Romania
T +40 722 145 213
F +40 356 800 513
www.ewarehouse.ro

RUSSIA
BIBUS O.O.O.

Str Zemskaja 94, 198205 St. Petersburg, Russia
T/F +7 812 309 41 51
T +7 800 100 14 52
www.bibus.ru
(not distributor for gas springs and HB dampers)

Gas spring & HB damper specialists:
TEHINNOVATION O.O.O.
Krasnodonskaya street 19, building 2, office 17
109386 Moscow, Russia
T +7 495 222 06 01
F +7 499 786 42 56
www.tehinnovation.ru

SERBIA
BIBUS DOO

Karadordeva, 76311 Dvorovi – Bijeljina
Bosnia and Herzegovina
T +387 55 423 444
F +387 55 423 444
www.bibus.ba
(not distributor for gas springs and HB dampers)

For gas springs & HB dampers:
ACE STOSSDÄMPFER GMBH
Albert-Einstein-Straße 15, 40764 Langenfeld, Germany
T +49 2173-9226-4100
F +49 2173-9226-89
www.ace-ace.com

SLOVAKIA
BIBUS SK S.R.O.

Trnavska cesta, 94901 Nitra, Slovakia
T +421 37 77 77 950
F +421 37 77 77 969
www.bibus.sk
(not distributor for gas springs and HB dampers)

Gas spring & HB damper specialists:
PNEUTRADE S.R.O.
Rybárska 8, 949 01 Nitra, Slovakia
T +421 37 65 24 338
F +421 37 65 55 933
www.pneutrade.sk

SLOVENIA
INOTEH D.O.O.

K Zeleznici 7, 2345 Bistrica ob Dravi, Slovenia
T +386 (0)2 665 1131
F +386 (0)2 665 2081
www.inoteh.si
(not distributor for gas springs and HB dampers)

For gas springs & HB dampers:
ACE STOSSDÄMPFER GMBH
Albert-Einstein-Straße 15, 40764 Langenfeld, Germany
T +49 2173-9226-4100
F +49 2173-9226-89
www.ace-ace.com

SOUTH AFRICA
PNEUMARK CONTROLS

94A Crompton Street, Pinetown 3610, South Africa
T +27 31 701 0421
F +27 86 551 2026
www.pneumark.co.za

SPAIN
AIRCONTROL INDUSTRIAL S.L.

Paseo Sarroeta 4
20014 Donostia-San Sebastian, Spain
T +34 943 44 50 80
F +34 943 44 51 53
www.aircontrol.es

BIBUS SPAIN S.L.
Poligono Industrial Porto do Molle
Rua do Aroncal, Vial C – Nave 4A
36350 Nigran (Pontevedra), Spain
T +34 986 24 72 86
F +34 986 20 92 47
www.bibus.es
(not distributor for gas springs and HB dampers)

SWEDEN
HYDNET AB

Turebergsvagen 5, 191 47 Sollentuna, Sweden
T +46 8 59 470 470
F +46 8 59 470 479
www.hydnet.se

SWITZERLAND
BIBUS AG

Allmendstrasse 26, 8320 Fehraltorf, Switzerland
T +41 44-877 50 11
F +41 44-877 58 51
www.bibus.ch
(not distributor for gas springs and HB dampers)

For gas springs & HB dampers:
ACE STOSSDÄMPFER GMBH
Albert-Einstein-Straße 15, 40764 Langenfeld, Germany
T +49 2173-9226-4100
F +49 2173-9226-89
www.ace-ace.com

TURKEY
BIBUS OTOMASYON SAN. VE TIC.LTD.STI.

Ziya Gökalp Mh. Bedrettin Dalan Bulv.
VIP Plaza No:43-44 İkitelli
Bağaçşehir / İstanbul, Turkey
T +90-212 293 82 00
F +90-212 249 88 34
www.bibus.com.tr
(not distributor for gas springs and HB dampers)

Gas spring & HB damper specialists:
POVVER PNÖMATİK A.S.
Necatibey Cad. No:44 Kat:2
34425 Karaköy/İstanbul, Turkey
T +90 212 293 88 70
F +90 212 293 68 77
www.powerpnomatik.com

UKRAINE
BIBUS UKRAINE TOV

1B, Kyivs'ka Str., Tarasivka
08161 Kyiv region, Ukraine
T +38 (044) 545 44 04
F +38 (044) 545 54 83
www.bibus.ua
(not distributor for gas springs and HB dampers)

Gas spring & HB damper specialists:
TECHVITAS LLC
Pyrohivskiy shliakh St 28, 03680 Kyiv, Ukraine
T +38 (050) 800 77 98 und +38 (044) 503-01-51
www.techvitas.com.ua

ACE Germany

The shortest way to the perfect shock absorber



ACE Stoßdämpfer GmbH

PO Box 1510
40740 Langenfeld

Albert-Einstein-Straße 15
40764 Langenfeld

Germany

T +49 (0)2173 - 9226-4100

F +49 (0)2173 - 9226-89



info@ace-int.eu

www.ace-ace.com

Global but always near

International ACE Sales Locations



GREAT BRITAIN
ACE Fabreeka UK

Unit 404 Easter Park, Haydock Lane
Haydock, WA11 9TH, U.K.

T +44 (0)1942 - 727 440

F +44 (0)1942 - 717 273

www.ace-controls.co.uk



JAPAN
ACE Controls Japan L.L.C.

City Center Bldg. II 2fl
3-1-42, Chigasaki-minami, Tsuzuki-ku
Yokohama, 224-0037, Japan

T +81 (0)45 - 945-0123

F +81 (0)45 - 945-0122

www.acecontrols.co.jp

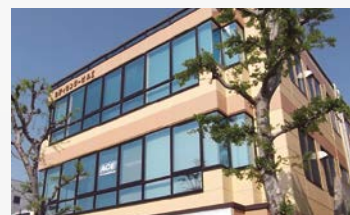

P.R. CHINA
ACE Controls

No. 8 Longxiang Road, Wujin National High-tech Industrial Zone,
Changzhou, Jiangsu Province, CN-213164, P. R. China

T +86 (0)519 - 8622-3520

F +86 (0)519 - 8622-3550

www.ace-ace.cn



USA
ACE Controls International Inc.

23425 Industrial Park Dr., Farmington Hills
Michigan 48335, USA

T +1 248 - 476-0213

F +1 248 - 476-2470

www.acecontrols.com

